

Panel mounted socket - Part no. 1501



- screw terminals
- 20° inclination
- 32A receptacles optional fitted with auxiliary contact

Protection type	IP 67
Ampere	32A
Poles	3p
Voltage	110V
Hertz	50-60 Hz
Earth position	4h
Contact	standard
Connection technology	Screw terminals

Std. Pack. 10 Qty.

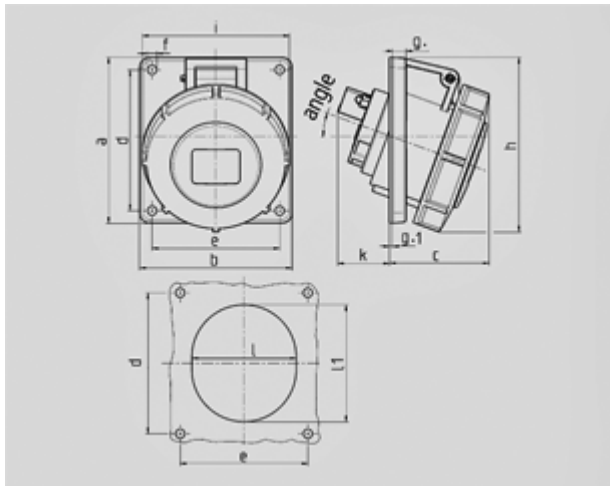

Drawing	Amp.	16			32		
		3	4	5	3	4	5
1 MB 251	Poles						
Dim. in mm	a	73,5	100	100	100	100	100
	b	64	92	92	92	92	92
	c	52	60	62	64	64	66
	d	60	85	85	85	85	85
	e	52	77	77	77	77	77
	f	5,5	5,5	5,5	5,5	5,5	5,5
	g	8	8	8	8	8	8
	g.1	2	2	2	2	2	2
	h	84	100	105	109	109	113
	i	78	85	96	103	103	110
	k	43	32	32	53	53	45
	l	52	55	65	67	67	72
	ll	60	63	72	82	82	85
	α	20°	20°	20°	20°	20°	20°
Terminal for cond. cross section (mm²) min.-max.		1,5	1,5	1,5	2,5	2,5	2,5
		—4	—4	—4	—10	—10	—10