

**Plug AM-TOP® - Part no. 289**

- screw terminals
- single part body
- cable gland and sealing
- strain relief and protection against kinking

Protection type	IP 67
Ampere	32A
Poles	3p
Voltage	110V
Hertz	50-60 Hz
Earth position	4h
Contact	standard
Connection technology	Screw terminals

Std. Pack. 10 Qty.

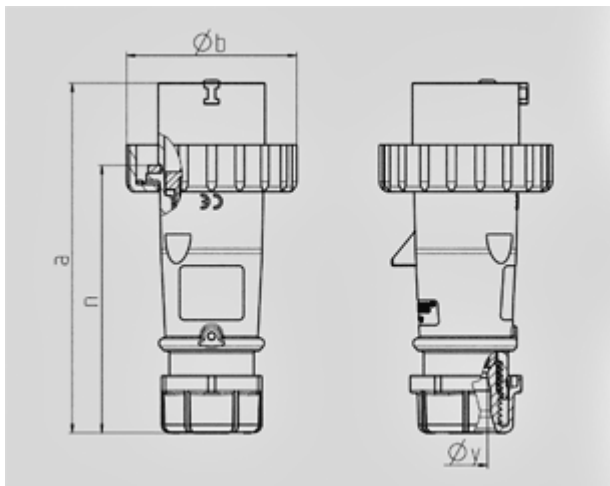

Drawing	Amp.	16			32		
		Poles			Poles		
2 MB 218		3	4	5	3	4	5
Dim. in mm	a	142	144	147	186	186	180
	b	70	78	87	94	94	101
	n	109	111	114	145	145	138
	y	14,5	16	16	22	22	22
Terminal for cond. cross		1	1	1	2,5	2,5	2,5
section (mm <sup>2</sup> ) min.-max.		-2,5	-2,5	-2,5	-6	-6	-6