

Connector AM-TOP® - Part no. 513

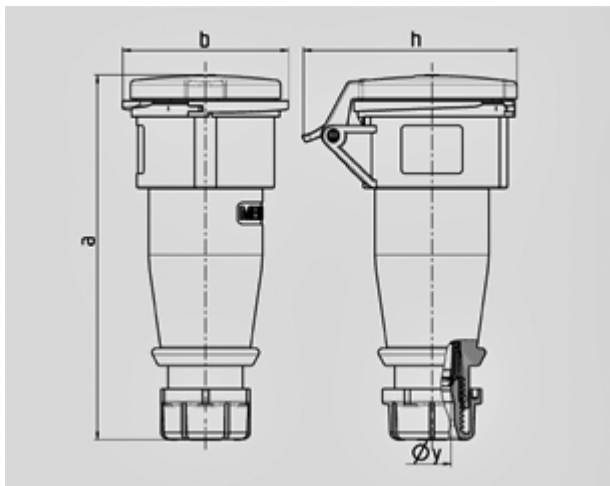

- screw terminals
- single part body
- cable gland and sealing
- strain relief and protection against kinking

Protection type	IP 44
Ampere	16A
Poles	4p
Voltage	230V
Hertz	50-60 Hz
Earth position	9h
Contact	standard
Connection technology	Screw terminals



Drawing	Amp.	16			32		
		3	4	5	3	4	5
3 MB 63	Poles						
Dim. in mm	a	162	165	167	209	209	208
	b	60	68	76	82	82	89
	h	83	92	98	100	100	108
	y	14,5	16	16	22	22	22
Terminal for cond. cross		1	1	1	2,5	2,5	2,5
section (mm ²) min.-max.		-2,5	-2,5	-2,5	-6	-6	-6