

Wall mounted receptacle - Part no. 7313

- screw terminals
- fused with RCD (0.03A)
- other leakage current ratings on request

Technical information

Ampere	32 A
Poles	5 p
Voltage	400V
Earth position	6 h
Hertz	50-60 Hz
Connection technology	Screw terminals
Contact	standard
Protection type	IP 44

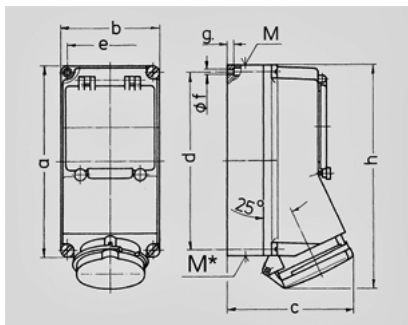

Drawing 1 MB 168	Amp. Poles	16			32		
		3	4	5	3	4	5
Dim. in mm	a	225	225	225	225	225	225
	b	118	118	118	118	118	118
	c	141	141	141	146	146	146
	d	208	208	208	208	208	208
	e	101	101	101	101	101	101
	f	6,3	6,3	6,3	6,3	6,3	6,3
	g	8	8	8	8	8	8
	h	250	252	254	264	264	264
	M	1x25 and 1x32			1x25 and 1x32		
	M*	2x25	2x25	2x25	2x25	2x25	2x25
	Max. cable diam. (mm)	25	25	25	25	25	25
	Terminal for cond. cross section (mm²) min.-max.	1,5	1,5	1,5	2,5	2,5	2,5
		-4	-4	-4	-10	-10	-10