

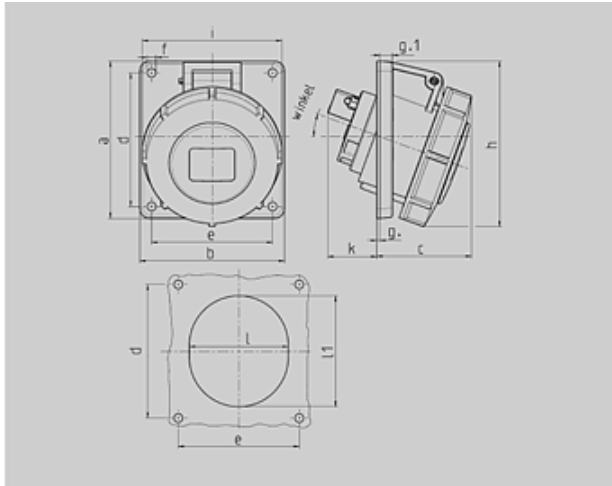

Part no. : 1485

Panel mounted receptacle

Drawing	Amp. Poles	16			32			
		3	4	5	3	4	5	
1 MB 251	Dim. in mm	a	73,5	100	100	100	100	100
		b	64	92	92	92	92	92
		c	52	60	62	64	64	66
		d	60	85	85	85	85	85
		e	52	77	77	77	77	77
		f	5,5	5,5	5,5	5,5	5,5	5,5
		g	7	8	8	8	8	8
		h	2	2	2	2	2	2
		i	84	100	105	109	109	113
		j	78	85	96	103	103	110
		k	43	32	33	33	53	45
		l	52	55	65	67	67	72
		l1	60	63	72	82	82	85
		α	20°	20°	20°	20°	20°	20°
	Terminal for cond. cross section (mm²) min.-max.	1,5	1,5	1,5	2,5	2,5	2,5	
		-4	-4	-4	-10	-10	-10	

Article-group : 1048

voltages : 400V

rated current : 16A

pole : 5 pole







IP protection types : IP67

position of ground contact : 6h

packing unit : 0010

weight : 210 g

PART NUMBERS

	V	110V	230V	400V	500V	>50-500V	
	Hz	50,60	50,60	50,60	50,60	100-300	300-500
	colour						
	amp.						
16 A	3	1474	1475	1476			
	4		1478	1479	1480	1481	
	5			1485			
32 A	3	1501	1502	1503			
	4		1505	1506	1507	1567	
	5			1551			