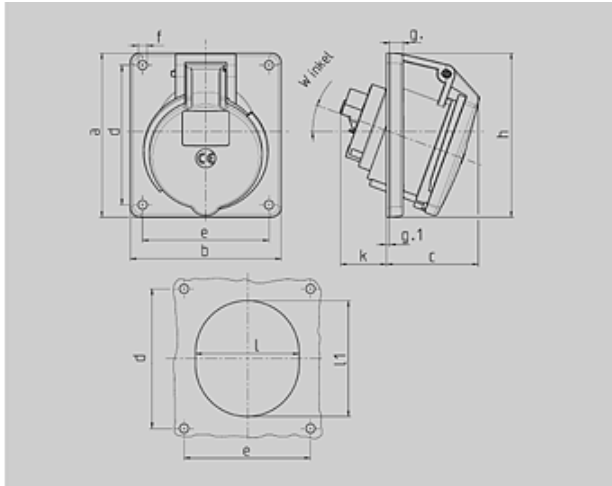

Part no. : 1492

Panel mounted receptacle

Drawing	Amp. Poles	16			32			
		3	4	5	3	4	5	
1 MB 260	Dim. in mm	a	73,5	100	100	100	100	100
	b	64	92	92	92	92	92	
	c	52	58	58	62	62	62	
	d	60	85	85	85	85	85	
	e	52	77	77	77	77	77	
	f	5,5	5,5	5,5	5,5	5,5	5,5	
	g.	7	8	8	8	8	8	
	g.1	2	2	2	2	2	2	
	h	79	100	100	103	103	107	
	k	43	32	32	53	53	45	
	l	52	55	65	67	67	72	
	l1	60	63	72	82	82	85	
	α	20°	20°	20°	20°	20°	20°	
Terminal for cond. cross section (mm²) min.-max.	1,5	1,5	1,5	2,5	2,5	2,5		
	-4	-4	-4	-10	-10	-10		

Article-group : 1044

voltages : 230V

rated current : 32A

pole : 3 pole







IP protection types : IP44

position of ground contact : 6h

packing unit : 0010

weight : 250 g

PART NUMBERS

V	Hz	colour	amp.	110V	230V	400V	500V	>50-500V	
				50,60	50,60	50,60	50,60	100-300	300-500
16 A	3			1462	1463	1464		3186	3187
	4			1465	1466	1467	1468	1469	1470
	5			1471	1472	1473	3188	3189	3190
32 A	3			1491	1492	1493		3201	3202
	4			1494	1495	1496	1497	1486	1487
	5			1498	1499	1500	3191	3192	3193