



Part no. : 1983

Panel mounted inlet

Contacts: nickel plated

Cage terminals

Contact carrier: highly heat resistant

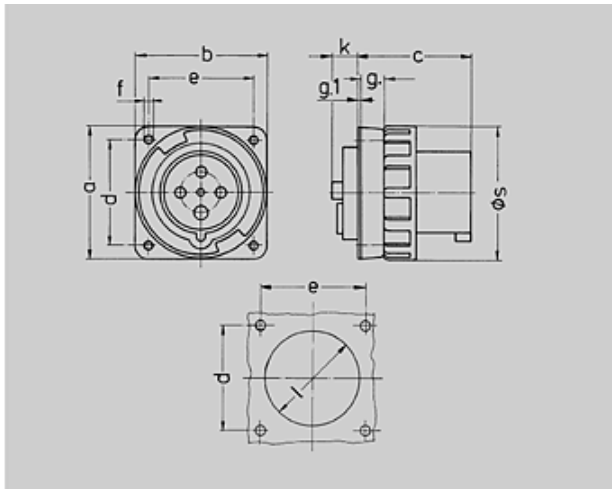

| Drawing | Amp. | 63 | | | 125 | | | |
|-------------------|--|-----|-----|-----|-----|-----|-----|-----|
| | | 3 | 4 | 5 | 3 | 4 | 5 | |
| 2 MB 166 | Poles | | | | | | | |
| Dim. in mm | a | 110 | 110 | 110 | 130 | 130 | 130 | |
| | b | 106 | 106 | 106 | 130 | 130 | 130 | |
| | c | 86 | 86 | 86 | 112 | 112 | 112 | |
| | d | 90 | 90 | 90 | 104 | 104 | 104 | |
| | e | 90 | 90 | 90 | 104 | 104 | 104 | |
| | f | 5,5 | 5,5 | 5,5 | 6,5 | 6,5 | 6,5 | |
| | g. | 11 | 11 | 11 | 18 | 18 | 18 | |
| | g.1 | 2 | 2 | 2 | 2 | 2 | 2 | |
| | k | 28 | 28 | 28 | 28 | 28 | 28 | |
| | l | 73 | 73 | 73 | 95 | 95 | 95 | |
| | s | 113 | 113 | 113 | 132 | 132 | 132 | |
| | Terminal for cond. cross section (mm²) min.-max. | | 6 | 6 | 6 | 25 | 25 | 25 |
| | | | -16 | -16 | -16 | -70 | -70 | -70 |

 Article-group : **2076**

voltages : 400V

rated current : 125A

pole : 5 pole







IP protection types : IP67

position of ground contact : 6h

packing unit : 0005

weight : 1125 g

PART NUMBERS

| | V | 110V | 230V | 400V | 500V | >50-500V | |
|--------------|---|---|---|---|---|---|---|
| | | 50,60 | 50,60 | 50,60 | 50,60 | 100-300 | 300-500 |
| colour | |  |  |  |  |  |  |
| amp. | | | | | | | |
| 63 A | 3 | 835 | 836 | | | | |
| | 4 | | 3704 | 3656 | 3657 | | |
| | 5 | | | 3658 | | | |
| 125 A | 3 | | 3665 | | | | |
| | 4 | | 3413 | 3583 | 3600 | | |
| | 5 | | | 1983 | | | |