

order number : 3658

Panel mounted inlet

Contacts: nickel plated

Cage terminals

Contact carrier: highly heat resistant

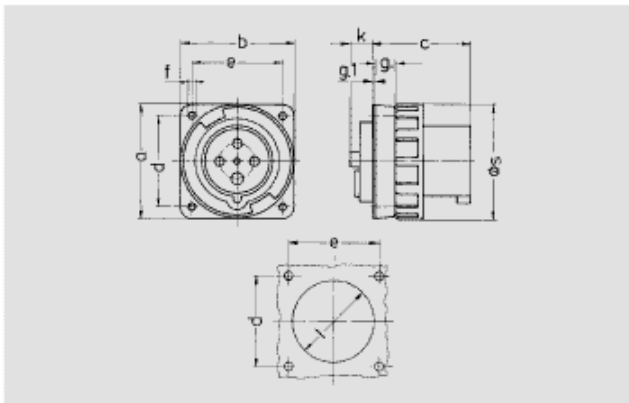
 63A5P 6H400V panel mounted inlet TA IP67
 with frame terminal

Zeichnung	Amp.	63			125			
		3	4	5	3	4	5	
2 MB 166	Pole							
Maße in mm	a	110	110	110	130	130	130	
	b	106	106	106	130	130	130	
	c	86	86	86	112	112	112	
	d	90	90	90	104	104	104	
	e	90	90	90	104	104	104	
	f	5,5	5,5	5,5	6,5	6,5	6,5	
	g	11	11	11	18	18	18	
	g.1	2	2	2	2	2	2	
	k	28	28	28	28	28	28	
	l	73	73	73	95	95	95	
	s	113	113	113	132	132	132	
	Leiterquerschnitt von bis mm ²		6	6	6	25	25	25
			-16	-16	-16	-70	-70	-70

 Article-group : **2076**

voltages : 400V

rated current : 63A

pole : 5 pole

IP protection types : IP67

position of ground contact : 6h







packing unit : 0005

contact carriers : reliable contact frame

contact technique : screw contact

weight : 590 g

PART NUMBERS

V	110V	230V	400V	500V	>50-500V	
Hz	50,60	50,60	50,60	50,60	100-300	300-500
colour						
amp.						
63 A	3	835	836			
	4		3704	3656	3657	
	5			3658		
125 A	3		3665			
	4		3413	3583	3600	
	5			1983		