

**Wall mounted socket - Part no. 7634**

- screw terminals
- for horizontal installation
- switched
- mechanical DUO-interlock
- sockets can be padlocked

Protection type	IP 67
Ampere	32 A
Poles	4p
Voltage	400
Hertz	50-60Hz
Earth position	6h
Contact	standard
Connection technology	Screw terminals

Std. Pack. 1 Qty.

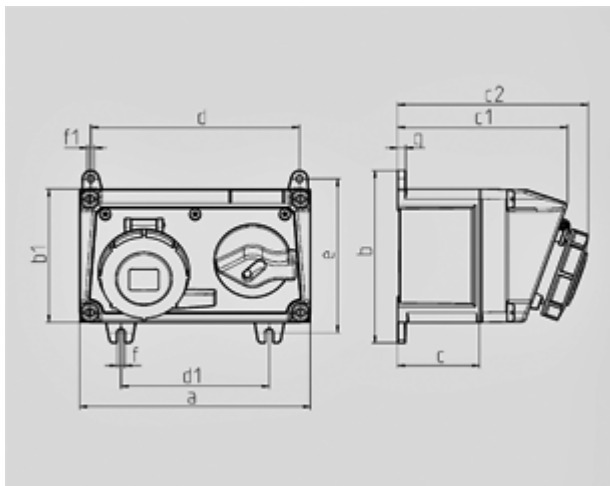

Drawing	Amp.	16			32		
		3	4	5	3	4	5
<b>1 MB 551</b>	<b>Poles</b>						
<b>Dim. in mm</b>	<b>a</b>	225	225	225	225	225	225
	<b>b</b>	168	168	168	168	168	168
	<b>b1</b>	130	130	130	130	130	130
	<b>c</b>	80	80	80	80	80	80
	<b>c1</b>	166	166	166	166	166	166
	<b>c2</b>	182	185	186	197	197	198
	<b>d</b>	204	204	204	204	204	204
	<b>d1</b>	145	145	145	145	145	145
	<b>e</b>	150	150	150	150	150	150
	<b>f</b>	7	7	7	7	7	7
	<b>f1</b>	Ø7	Ø7	Ø7	Ø7	Ø7	Ø7
	<b>g</b>	8	8	8	8	8	8