

# POINT Guard I/O Safety Modules

Catalog Numbers 1734-IB8S, 1734-OB8S, 1734-IE4S, 1734-OBV2S



## Important User Information

Read this document and the documents listed in the additional resources section about installation, configuration, and operation of this equipment before you install, configure, operate, or maintain this product. Users are required to familiarize themselves with installation and wiring instructions in addition to requirements of all applicable codes, laws, and standards.

Activities including installation, adjustments, putting into service, use, assembly, disassembly, and maintenance are required to be carried out by suitably trained personnel in accordance with applicable code of practice.

If this equipment is used in a manner not specified by the manufacturer, the protection provided by the equipment may be impaired.

In no event will Rockwell Automation, Inc. be responsible or liable for indirect or consequential damages resulting from the use or application of this equipment. In case of malfunction or damage, no attempts at repair should be made. The module should be returned to the manufacturer for repair. Do not dismantle the module.

The examples and diagrams in this manual are included solely for illustrative purposes. Because of the many variables and requirements associated with any particular installation, Rockwell Automation, Inc. cannot assume responsibility or liability for actual use based on the examples and diagrams.

No patent liability is assumed by Rockwell Automation, Inc. with respect to use of information, circuits, equipment, or software described in this manual.

Reproduction of the contents of this manual, in whole or in part, without written permission of Rockwell Automation, Inc., is prohibited

Throughout this manual, when necessary, we use notes to make you aware of safety considerations.



**WARNING:** Identifies information about practices or circumstances that can cause an explosion in a hazardous environment, which may lead to personal injury or death, property damage, or economic loss.



**ATTENTION:** Identifies information about practices or circumstances that can lead to personal injury or death, property damage, or economic loss. Attentions help you identify a hazard, avoid a hazard, and recognize the consequence.

---

### **IMPORTANT**

Identifies information that is critical for successful application and understanding of the product.

---

Labels may also be on or inside the equipment to provide specific precautions.



**SHOCK HAZARD:** Labels may be on or inside the equipment, for example, a drive or motor, to alert people that dangerous voltage may be present.



**BURN HAZARD:** Labels may be on or inside the equipment, for example, a drive or motor, to alert people that surfaces may reach dangerous temperatures.



**ARC FLASH HAZARD:** Labels may be on or inside the equipment, for example, a motor control center, to alert people to potential Arc Flash. Arc Flash will cause severe injury or death. Wear proper Personal Protective Equipment (PPE). Follow ALL Regulatory requirements for safe work practices and for Personal Protective Equipment (PPE).

---

<b>Preface</b>	Summary of Changes . . . . .	9
	Terminology . . . . .	9
	Additional Resources . . . . .	10
	 <b>Chapter 1</b>	
<b>POINT Guard I/O Overview</b>	Understand Suitability for Use . . . . .	11
	Safety Precautions . . . . .	13
	Installing and Replacing Modules . . . . .	13
	Securing the System . . . . .	14
	POINT Guard I/O Modules in CIP Safety Systems . . . . .	15
	1734-IB8S Digital Input Module Features . . . . .	15
	1734-OB8S Safety Digital Output Module Features . . . . .	16
	1734-OBV2S POINT Guard I/O Module Features . . . . .	16
	1734-IE4S Safety Analog Input Module Features . . . . .	17
	Programming Requirements . . . . .	17
	CIP Safety Architectures . . . . .	18
	Safety Application Requirements . . . . .	19
	 <b>Chapter 2</b>	
<b>Safety Inputs, Safety Outputs, and Safety Data</b>	Safe States . . . . .	21
	POINT Guard Digital I/O Modules . . . . .	21
	POINT Guard I/O Analog Input Module . . . . .	22
	Safety Inputs (1734-IB8S) . . . . .	22
	Using a Test Output with a Safety Input . . . . .	22
	Single-channel Mode . . . . .	24
	Dual-channel Mode and Discrepancy Time . . . . .	25
	Dual-channel, Equivalent . . . . .	26
	Dual-channels, Complementary . . . . .	27
	Safety Input Fault Recovery . . . . .	28
	Input Delays . . . . .	28
	Safety Analog Inputs (1734-IE4S) . . . . .	29
	Input Range . . . . .	29
	Scaling . . . . .	29
	Digital Input Filter . . . . .	30
	Sensor Power Supply . . . . .	30
	Channel Offset . . . . .	31
	Process Alarms . . . . .	31
	Using a Single-channel Sensor . . . . .	32
	Dual-channel Equivalent Mode . . . . .	33
	Tachometer Mode . . . . .	34
	Safety Outputs (1734-OB8S and 1734-OBV2S) . . . . .	37
	Safety Output with Test Pulse . . . . .	37
	Dual-channel Mode . . . . .	38
	Single-channel Mode, 1734-OB8S Only . . . . .	39
	Safety Output Fault Recovery . . . . .	39
	Muting Lamp Operation (1734-IB8S) . . . . .	40

	I/O Status Data . . . . .	41
	Digital I/O Status Data . . . . .	42
	Analog I/O Status Data . . . . .	42
	<b>Chapter 3</b>	
<b>Guidelines for Placing Power Supplies and Modules in a System</b>	Choosing a Power Supply . . . . .	43
	Power Supply Examples . . . . .	45
	Example 1: Isolating Field Power Segments . . . . .	45
	Example 2: POINT Guard I/O Used with AC I/O Modules . . . . .	46
	Placing Series A Digital and Analog Modules . . . . .	47
	Placing Series B Digital Modules . . . . .	48
	<b>Chapter 4</b>	
<b>Install the Module</b>	Precautions . . . . .	50
	European Hazardous Location Approval . . . . .	51
	North American Hazardous Location Approval . . . . .	52
	Environment and Enclosure . . . . .	52
	Prevent Electrostatic Discharge . . . . .	53
	Mount the Module . . . . .	53
	Install the Mounting Base . . . . .	53
	Connect the Module to the Mounting Base . . . . .	55
	Connect the Removable Terminal Block . . . . .	56
	Remove a Mounting Base . . . . .	57
	Wire Modules . . . . .	57
	Terminal Layout . . . . .	59
	Connection Details . . . . .	61
	Wiring Examples . . . . .	63
	Emergency Stop Dual-channel Devices . . . . .	63
	Single-channel Safety Contactor . . . . .	64
	Dual-channel Safety Contactors . . . . .	65
Bipolar Safety Outputs . . . . .	66	
Safety Analog Input Wiring . . . . .	67	



## Configure the Module in a GuardLogix Controller System

### Chapter 5

Set up the Module.....	75
Add and Configure the Ethernet Bridge.....	76
Add and Configure the 1734 Ethernet Adapter.....	77
Add and Configure Safety Digital Input Modules.....	80
Add the Safety Digital Input Module.....	80
Configure the Safety Digital Inputs.....	85
Configure the Test Outputs.....	88
Add and Configure Safety Digital Output Modules.....	89
Add the Safety Digital Output Module.....	89
Configure the Safety Digital Outputs.....	93
Add and Configure Safety Analog Input Modules.....	94
Add the Safety Analog Input Module.....	94
Configure the Safety Analog Input Channel Operation.....	97
Configure the Safety Analog Inputs.....	98
Configure Safety Analog Input Alarms (Optional).....	99
Configure Tachometer Operation.....	101
Values and States of Tags.....	103
Configure Safety Connections.....	105
Configuration Ownership.....	106
Save and Download the Module Configuration.....	107
Update POINT Guard I/O Modules.....	107

## Configure the Module for a SmartGuard Controller

### Chapter 6

Before You Begin.....	110
Set the Node Address.....	110
Auto-addressing with a 1734-PDN Adapter.....	112
Set Up Your DeviceNet Network.....	114
Configure the POINT Guard I/O Modules.....	115
Configure Digital Safety Inputs and Test Outputs.....	115
Configure Digital Safety Outputs.....	118
Configure Safety Analog Inputs.....	119
Configure the SmartGuard Controller.....	124
Set Up the Input and Output Connections.....	124
Complete the Set Up of the SmartGuard Controller.....	128
Save and Download Module Configuration.....	129

<b>Configuring Safety Connections between a GuardLogix Controller and POINT Guard I/O Modules on a DeviceNet Network</b>	<p><b>Chapter 7</b></p> <p>Configure the Module in RSNetWorx for DeviceNet Software .. 131</p> <p>Add the POINT Guard I/O Module to the Controller Project... 132</p> <p>Complete the Safety Configuration..... 136</p> <p>Download the DeviceNet Network Configuration..... 138</p> <p>Verify Your DeviceNet Safety Configuration ..... 139</p> <p style="padding-left: 20px;">Determine If Devices Can Be Verified..... 140</p> <p style="padding-left: 20px;">Select Devices to Verify ..... 141</p> <p style="padding-left: 20px;">Review the Safety Device Verification Reports ..... 143</p> <p style="padding-left: 20px;">Lock Safety Devices..... 143</p>
<b>Replacing POINT Guard I/O Modules</b>	<p><b>Chapter 8</b></p> <p>The Safety Network Number ..... 145</p> <p>Manually Setting the Safety Network Number..... 146</p> <p>Resetting a Module to Out-of-box Condition..... 147</p> <p style="padding-left: 20px;">By Using the Logix Designer Application..... 148</p> <p style="padding-left: 20px;">By Using RSNetWorx for DeviceNet Software..... 149</p> <p>Replace a Module in a GuardLogix System on an EtherNet/IP Network ..... 150</p> <p style="padding-left: 20px;">Replacement with 'Configure Only When No Safety Signature Exists' Enabled..... 150</p> <p style="padding-left: 20px;">Replacement with 'Configure Always' Enabled..... 155</p> <p>Replace a Module When Using a SmartGuard or GuardLogix Controller on a DeviceNet Network..... 157</p>
<b>Indicators</b>	<p><b>Appendix A</b></p> <p>Module ..... 162</p> <p>Network Status ..... 163</p> <p>Configuration Lock ..... 163</p> <p>Power ..... 163</p> <p style="padding-left: 20px;">1734-IE4S Sensor Power..... 163</p> <p style="padding-left: 20px;">1734-IE4S Safety Analog Input Status ..... 164</p> <p style="padding-left: 20px;">1734-IB8S Safety Input Status..... 164</p> <p style="padding-left: 20px;">1734-OB8S Safety Output Status..... 165</p> <p style="padding-left: 20px;">1734-OBV2S Safety Output Status ..... 165</p>

<b>Get I/O Diagnostic Status from Modules in Logix Systems</b>	<b>Appendix B</b>	
	Message Instructions . . . . .	167
	Configure the Message Instruction . . . . .	168
	Class, Instance, and Attribute Data for I/O Modules . . . . .	169
<b>Specifications</b>	<b>Appendix C</b>	
	Technical Specifications for Series A Modules . . . . .	173
	Safety Digital Input Module Specifications . . . . .	173
	Safety Digital Output Module Specifications . . . . .	175
	Safety Analog Input Module Specifications . . . . .	176
	Technical Specifications for Series B Modules . . . . .	185
	Safety Digital Input Module Specifications . . . . .	185
	Safety Digital Output Module Specifications . . . . .	188
	Safety Digital Output Module Specifications 1734-OBV2S . . . . .	190
	Environmental Specifications . . . . .	192
	Certifications . . . . .	195
	Standards . . . . .	195
<b>Safety Data</b>	<b>Appendix D</b>	
	. . . . .	197
	Series A Safety Data . . . . .	198
	Series B Safety Data . . . . .	201
	Product Failure Rates (failures per hour) . . . . .	205
<b>Configuration Parameters</b>	<b>Appendix E</b>	
	. . . . .	207
<b>I/O Assemblies</b>	<b>Appendix F</b>	
	Input Assemblies . . . . .	211
	Output Assemblies . . . . .	213
	Analog Input Assemblies . . . . .	213
	Configuration Assemblies . . . . .	215
	Using Data from Modules Configured Via the Generic Profile . . . . .	221
<b>Index</b>	. . . . .	223

**Notes:**

Thoroughly read and understand this manual before installing and operating a system that uses POINT Guard I/O™ modules.

Always observe the following guidelines when using a module. In this manual, we use safety administrator to mean a person who is qualified, authorized, and responsible to secure safety in the design, installation, operation, maintenance, and disposal of the ‘machine’.

- Keep this manual in a safe place where personnel can refer to it when necessary.
- Use the module properly according to the installation environment, performance ratings, and functions of the machine.

See [Understand Suitability for Use on page 11](#) and [Safety Precautions on page 13](#).

Product specifications and accessories can change at any time. Consult with your Rockwell Automation representative to confirm specifications of purchased product. Dimensions and weights are nominal and are not for manufacturing purposes, even when tolerances are shown.

Consult your Rockwell Automation representative if you have any questions or comments. Also refer to the related documentation, which is listed on [page 10](#), as necessary.

## Summary of Changes

We updated the ATTENTION statement on grounding on [page 58](#).

## Terminology

**Table 1 - Common Terms**

Term	Means
Connection	Logical communication channel for communication between nodes. Connections are maintained and controlled between masters and slaves.
EDS	Electronic data sheet, a template that is used in RSNetWorx™ software to display the configuration parameters, I/O data profile, and connection-type support for a given I/O module. RSNetWorx™ software uses these simple text files to identify products and commission them on a network.
ODVA	Open DeviceNet Vendor Association, a nonprofit association of vendors that are established for the promotion of CIP networks.
PFH	Probability of failure on demand, the average probability of a system to fail to perform its design function on demand.
PFH	Probability of failure per hour, the probability of a system to have a dangerous failure occur per hour.
Proof test	Periodic test that detects failures in a safety-related system so that, if necessary, the system can be restored to an as-new condition or as close as practical to this condition.
SNN	Safety network number, which uniquely identifies a network across all networks in the safety system. You are responsible for assigning a unique number for each safety network or safety subnet within a system.
Standard	Devices or portions of devices that do not participate in the safety function.

## Additional Resources

These documents contain additional information concerning related products from Rockwell Automation.

Resource	Description
POINT I/O™ Selection Guide, publication <a href="#">1734-SG001</a>	Provides selection information for POINT I/O™ modules. Additional publication references are listed as well.
GuardLogix® 5570 Controllers User Manual, publication <a href="#">1756-UM022</a>	Provides information on how to install, configure, program, and use GuardLogix 5570 controllers in Studio 5000 Logix Designer® projects.
GuardLogix 5570 Controller Systems Safety Reference Manual, publication <a href="#">1756-RM099</a>	Provides information on safety application requirements for GuardLogix 5570 controllers in Studio 5000 Logix Designer projects.
GuardLogix Controller Systems Safety Reference Manual, publication <a href="#">1756-RM093</a>	Provides information on safety system requirements and describes the GuardLogix® controller system.
GuardLogix Controllers User Manual, publication <a href="#">1756-UM020</a>	Provides information on how to install, configure, program, and use GuardLogix controllers in RSLogix 5000® projects.
GuardLogix Safety Application Instructions Safety Reference Manual, publication <a href="#">1756-RM095</a>	Provides reference information that describes the GuardLogix Safety Application Instruction Set.
SmartGuard 600 Controllers Safety Reference Manual, publication <a href="#">1752-RM001</a>	Describes SmartGuard™ 600-specific safety requirements and controller features.
Field Potential Distributor Installation Instructions, publication <a href="#">1734-IN059</a>	Provides installation information on 1734-FPD distributors.
POINT I/O 24V DC Expansion Power Supply Installation Instructions, publication <a href="#">1734-IN058</a>	Provides installation information on 1734-EP24DC power supplies.
POINT I/O 120/240V AC Expansion Power Supply Installation Instructions, publication <a href="#">1734-IN017</a>	Provides installation information on 1734-EPAC power supplies.
POINT I/O Wiring Base Assembly Installation Instructions, publication <a href="#">1734-IN511</a>	Provides installation information on 1734-TB and 1734-TBS assemblies.
POINT I/O One-piece Wiring Base Assembly Installation Instructions, publication <a href="#">1734-IN028</a>	Provides installation information on 1734-TOP, 1734-TOPS, 1734-TOP3, and 1734-TOP3S assemblies.
ODVA Media Planning and Installation Guide, <a href="http://www.odva.org">http://www.odva.org</a>	Describes the required media components and how to plan for and install these required components.
Industrial Automation Wiring and Grounding Guidelines, publication <a href="#">1770-4.1</a>	Provides general guidelines for installing a Rockwell Automation industrial system.
Product Certifications website, <a href="http://www.rockwellautomation.com/global/certification/overview.page">http://www.rockwellautomation.com/global/certification/overview.page</a>	Provides declarations of conformity, certificates, and other certification details.

You can view or download publications at <http://www.rockwellautomation.com/literature/>. To order paper copies of technical documentation, contact your local Allen-Bradley distributor or Rockwell Automation sales representative.

## POINT Guard I/O Overview

Topic	Page
Understand Suitability for Use	11
Safety Precautions	13
POINT Guard I/O Modules in CIP Safety Systems	15
Safety Application Requirements	19

Use the POINT Guard I/O™ safety modules in the POINT I/O™ platform to distribute safety I/O on a safety-control network that meets the requirements up to and including SIL CL3, and PLe, Cat. 4 as defined in IEC 61508, IEC 61511, IEC 62061, and ISO 13849-1. Guard I/O modules can be used with GuardLogix® controllers, Compact GuardLogix controllers, and SmartGuard™ Controllers.

You can configure the modules for use on DeviceNet networks by using the network configuration tool, RSNetWorx™ for DeviceNet software. For Ethernet networks, use the GuardLogix programming tool, the Logix Designer application.

### Understand Suitability for Use

Rockwell Automation is not responsible for conformity with any standards, codes, or regulations that apply to the combination of the products in your application or use of the product. See [Standards on page 195](#) for more information.

Take all necessary steps to determine the suitability of the products for the systems, machine, and equipment with which it is used.

Know and observe all prohibitions of use applicable to these products.

Use this equipment within its specified ratings.

Never use these products for an application that involves serious risk to life or property without making sure that the system as a whole was designed to address the risks. Be sure that Rockwell Automation products are properly rated and installed for the intended use within the overall equipment or system.

Only download firmware and access product release notes from the Rockwell Automation official download portal at <http://www.rockwellautomation.com/rockwellautomation/support/pcdc.page>.

Do not download firmware from non-Rockwell Automation sites.

Verify that the POINT Guard I/O firmware revision is correct before you commission the safety system. Firmware information for safety I/O modules is available at

<http://www.rockwellautomation.com/products/certification/safety>.

**TIP** Field power must be applied to the 1734-IE4S module when updating firmware.

Verify that a safety administrator conducts a risk assessment on the machine and determines module suitability before installation.



**ATTENTION:** Personnel responsible for the application of safety-related programmable electronic systems (PES) shall be aware of the safety requirements in the application of the system and shall be trained in the use of the system.



**ATTENTION:** Use only appropriate components or devices that comply with relevant safety standards that correspond to the required safety category and safety integrity level.

- Conformity to requirements of the safety category and safety integrity level must be determined for the entire system.
- We recommend that you consult a certification body regarding assessment of conformity to the required safety integrity level or safety category.

You are responsible for confirming compliance with the applicable standards for the entire system.

**Table 1 - Requirements for Controlling Devices**

Device	Requirement	Allen-Bradley® Bulletin Safety Components
Emergency stop switches	Use approved devices with direct opening mechanisms that comply with IEC/EN 60947-5-1.	Bulletin 800F, 800T
Door interlocking switches, limit switches	Use approved devices with direct opening mechanisms that comply with IEC/EN 60947-5-1 and capable of switching microloads of 24V DC, 3 mA.	Bulletin 440K, 440G, 440H for interlock switch Bulletin 440P, 802T for limit switch
Safety sensors	Use approved devices that comply with the relevant product standards, regulations, and rules in the country where used.	Any Guardmaster® product
Relays with forcibly- guided contacts, contactors	Use approved devices with forcibly guided contacts that comply with EN 50205. For feedback purposes, use devices with contacts capable of switching micro loads of 24V DC, 3 mA.	Bulletin 700S, 100S
Other devices	Evaluate whether devices used are appropriate to satisfy the requirements of safety category levels.	-



## Safety Precautions

Observe these precautions for proper use of POINT Guard I/O modules.



**ATTENTION:** As serious injury can occur due to loss of required safety function, follow these safety precautions.

- Never use test outputs as safety outputs. Test outputs are not safety outputs.
- Do not use Ethernet, DeviceNet, or ControlNet standard I/O data or explicit message data as safety data.
- Do not use light-emitting diode (LED) status indicators on the I/O modules for safety operations.
- Do not connect loads beyond the rated value to the safety outputs.
- Apply properly specified voltages to the module. Applying inappropriate voltages can cause the module to fail to perform its specified function, which could lead to loss of safety functions or damage to the module.
- Wire the POINT Guard I/O modules properly following the wiring requirements and guidelines in [Wire Modules on page 57](#).
- Set unique network node addresses before connecting devices to the network.
- Perform testing to confirm that device wiring, configuration, and operation is correct before starting system operation.
- Do not disassemble, repair, or modify the module. This can result in loss of safety functions.

## Installing and Replacing Modules



**ATTENTION:**

- Clear previous configuration data before connecting devices to the network or connecting input or output power to the device.
- Configure the replacement device properly and confirm that it operates correctly.
- After installation of the module, a safety administrator must confirm the installation and conduct trial operation and maintenance.

When you clean a module, do **not** use the following:

- Thinner
- Benzene
- Acetone

## Securing the System

To secure access to the [device] by authorized users only, consider these options:

- Password protect the source and execution of the control program
- Remove the key from the controller
- Deploy EtherNet/IP devices in accordance with recommended architectures and concepts. See the Converged Plantwide Ethernet (CPwE) Design and Implementation Guide, publication [ENET-TD001](#)
- Implement physical barriers, such as locked cabinets

To secure access to the system, consider these options:

- Follow industry best practices to harden your personal computers and servers, including anti-virus/anti-malware and application whitelisting solutions. These recommendations are published in Knowledgebase article [KB546987](#).
- Develop and deploy backup and disaster recovery policies and procedures. Test backups on a regular schedule.
- Minimize network exposure for all control system devices and systems, and verify that they are not accessible from the Internet.
- Locate control system networks and devices behind firewalls and isolate them from the business network.
- Subscribe to Rockwell Automation's Security Advisory Index, Knowledgebase article [KB54102](#) so you have access to information about security matters that affect Rockwell Automation products.

## POINT Guard I/O Modules in CIP Safety Systems

POINT Guard I/O modules are used in the POINT I/O platform and implement CIP Safety protocol extensions over EtherNet/IP and DeviceNet networks to communicate safety messages. POINT Guard I/O modules connect to EtherNet/IP or DeviceNet networks via these network adapters.

**Table 2 - Network Adapters**

Network	System	Adapter <sup>(1)</sup>
EtherNet/IP	GuardLogix	1734-AENT (Firmware Revision 3 or later)
		1734-AENTR
DeviceNet	SmartGuard or GuardLogix	1734-PDN

(1) Not compatible with 1734-ADN, 1734-ADNX, 1734-APB, or 1734-ACNR adapters.

Distributed I/O communication for safety I/O data is performed through safety connections that support CIP Safety over an EtherNet/IP or DeviceNet network. Data processing is performed in the safety controller. A control monitors the status and fault diagnostics of POINT Guard I/O modules.

In addition to I/O state data, the modules include status data for monitoring I/O faults within each circuit.

A password can help protect the configuration information of the modules.

### 1734-IB8S Digital Input Module Features

- Safety digital inputs
  - Safety devices, such as Emergency Stop Push Button, gate switches, and safety light curtains, can be connected.
  - Dual-channel mode evaluates consistency between two input signals (channels), which allows use of the module for safety Category 3 and 4 and in applications that are rated up to and including Performance Level e/SIL CL3 when both channels' Point Mode configurations are set to Safety Pulse Test.
  - Single-channel mode evaluates one input signal (channel), which allows use of the module for safety Category 2 and in applications that are rated up to and including Performance Level d/SIL CL 2 when the channel's Point Mode configuration is set to Safety Pulse Test.
  - You can configure a discrepancy time to control how long two channels are allowed to be discrepant before a fault is declared.
  - An external wiring short circuit check is possible when inputs are wired in combination with test outputs. The module must be wired in combination with test outputs when this function is used.
  - Independently adjustable on and off delays are available per channel.

- Test outputs (digital input modules only)
  - Separate test outputs are provided for short circuit detection of a safety input (or inputs).
  - Power (24V) can be supplied to devices, such as safety sensors.
  - Test outputs can be configured as standard outputs.
  - Specific test outputs can be used for broken-wire detection of a muting lamp.

### 1734-OB8S Safety Digital Output Module Features

- Solid-state outputs
- Dual-channel mode provides redundant control by using two output signals (channels), which allows use of the module for safety Category 3 and 4, and applications that are rated up to and including Performance Level e/SIL CL3 when both channels' Point Mode configurations are set to Safety Pulse Test.
- Single-channel mode provides control by using one output signal (channel), which allows use of the module for safety Category 2, and applications that are rated up to and including Performance Level d/SIL CL2 when the channel's Point Mode configuration is set to Safety Pulse Test.

---

**IMPORTANT** 1734-OB8S Single-channel mode is only certified for functional safety applications with process safety times greater than or equal to 600 ms; or, applications with demand rates less than or equal to 1 demand per minute.

---

- Safety outputs can be pulse-tested to detect field wiring short circuits to 24V DC.

### 1734-OBV2S POINT Guard I/O Module Features

- 4 Bipolar outputs (2 pairs)
- Dual-channel mode provides redundant control by using two output signals (channels), which allows use of the module for safety Category 3 and 4, and applications that are rated up to and including Performance Level e/SIL CL3 when both channels' Point Mode configurations are set to Safety Pulse Test.
- Safety outputs can be pulse-tested to detect field wiring short circuits to 24V DC (for the sourcing output of the bipolar pair) and ground (for the sinking output of the bipolar pair).

## 1734-IE4S Safety Analog Input Module Features

- Connection of up to four voltage or current sensors.
- Sensor power outputs are individually current-limited and monitored.
- Measurement of process variables, such as temperature, pressure, or flow rate.
- Seven configurable input ranges ( $\pm 10V$ ,  $\pm 5V$ ,  $0\dots 5V$ ,  $0\dots 10V$ ,  $4\dots 20\text{ mA}$ ,  $0\dots 20\text{ mA}$ , Tachometer).
- Tachometer mode converts 24V DC switching signals into pulses per second.
- Single-channel or dual-channel for SIL 3-rated safety devices and applications.
- Dual-channel mode evaluates the consistency between two input signals (channels), which allows use of the module in applications that are rated up to and including SIL CL3/PLe/Cat. 4.
- You can configure a discrepancy time to control how long two channels are allowed to be discrepant before a fault is declared.

## Programming Requirements

Use the minimum Software Versions listed here.

Cat. No.	Studio 5000® Environment Version <sup>(1)</sup>	RSLogix 5000® Software Version <sup>(1)</sup> (EtherNet/IP Network)	RSNetWorx™ for DeviceNet Software Version <sup>(1)</sup> (DeviceNet Network)
1734-IB8S, 1734-OB8S	21	17 <sup>(2)</sup>	9
1734-OBV2S	21	18	21
1734-IE4S	21	18 <sup>(3)</sup>	10

(1) This version or later.

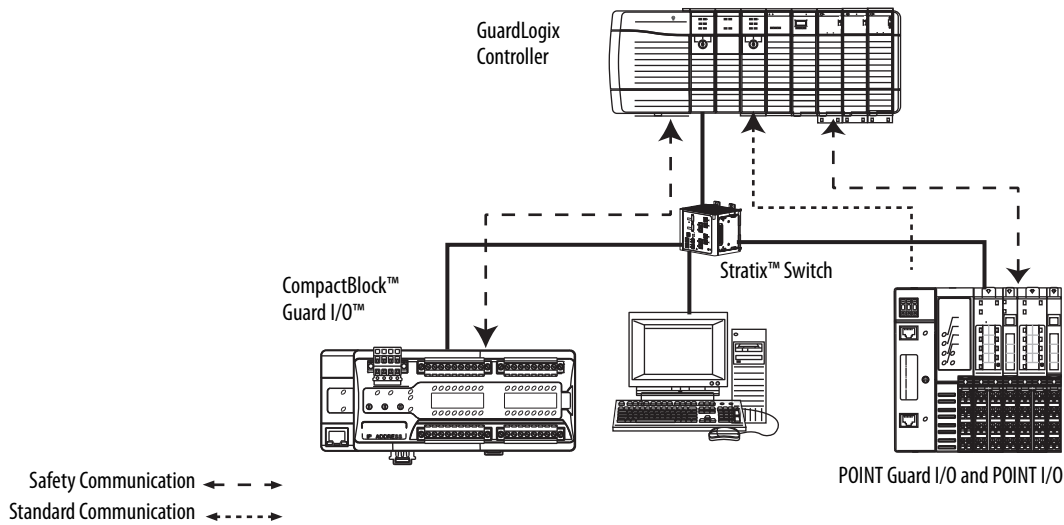
(2) If you are using digital POINT Guard I/O modules with the analog POINT Guard I/O module, you must update the Add-on Profiles to version 2.02.004 or later for the modules to be compatible with version 18 or later of RSLogix 5000 software and the Studio 5000 Environment. To find Add-on Profiles, go to <http://www.rockwellautomation.com/support>.

(3) Dual-channel Analog (DCA) safety application instruction is available in RSLogix 5000 software, version 20 or later and Studio 5000 Environment, version 21 and later.

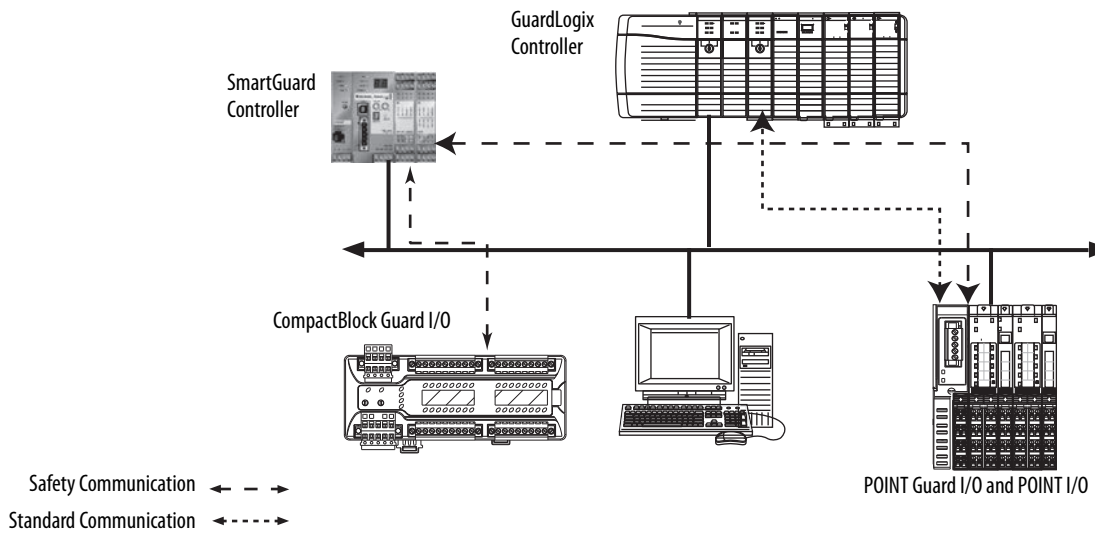
## CIP Safety Architectures

Use POINT Guard I/O modules in EtherNet/IP or DeviceNet safety architectures. Safety controllers control the safety outputs. Safety or standard PLC controllers can control the standard outputs.

**Figure 1 - POINT Guard I/O Modules in EtherNet/IP Safety Architecture**



**Figure 2 - POINT Guard I/O Modules in DeviceNet Safety Architectures**



## Safety Application Requirements

POINT Guard I/O modules are certified for use in safety applications up to and including Performance Level e (PLe/Cat. 4) and Safety Integrity Level 3 (SIL CL3) in which the de-energized state is the safe state. Safety application requirements include evaluating probability of failure rates (PFD and PFH), system reaction time settings, and functional verification tests that fulfill SIL 3 criteria.

Creating, recording, and verifying the safety signature is also a required part of the safety application development process. The safety controller creates the safety signatures. The safety signature consists of an identification number, date, and time that uniquely identifies the safety portion of a project. This number includes all safety logic, data, and safety I/O configuration.

For safety system requirements, including information on the safety network number (SNN), verifying the safety signature, functional verification test intervals, system reaction time, and PFD/PFH calculations, refer to the following publications.

<b>For safety requirements in:</b>	<b>See:</b>
GuardLogix controller systems	GuardLogix 5570 Controller Systems Safety Reference Manual, publication <a href="#">1756-RM099</a>
SmartGuard 600 controller systems	SmartGuard 600 Controllers Safety Reference Manual, publication <a href="#">1752-RM001</a>

You must read, understand, and fulfill the requirements that are detailed in these publications before operating a safety system that uses POINT Guard I/O modules.

**Notes:**



## Safety Inputs, Safety Outputs, and Safety Data

Topic	Page
Safe States	21
Safety Inputs (1734-IB8S)	22
Safety Analog Inputs (1734-IE4S)	29
Safety Outputs (1734-OB8S and 1734-OBV2S)	37
Muting Lamp Operation (1734-IB8S)	40
I/O Status Data	41

### Safe States

### POINT Guard Digital I/O Modules



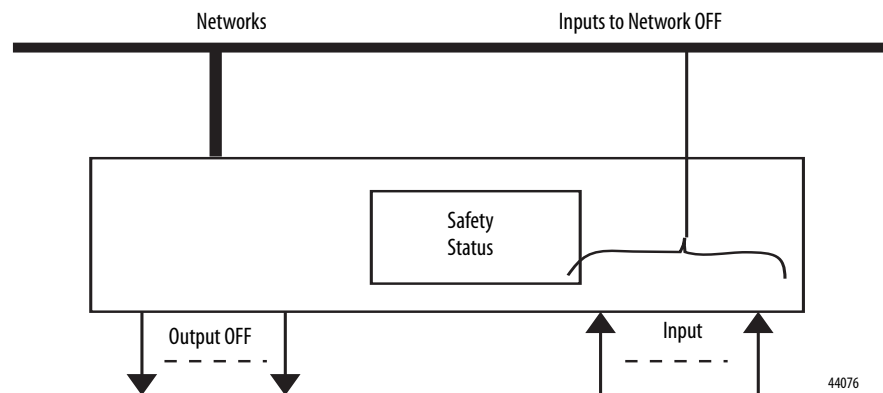
**ATTENTION:**

- The safe state of the outputs is defined as the off state.
- The safe state of the module and its data is defined as the off state.
- Use the POINT Guard I/O™ module only in applications where the off state is the safe state.

The following are the safe states of the digital POINT Guard I/O™ modules:

- Safety outputs: OFF
- Safety input data to network: OFF (single channel and dual-channel equivalent)
- Safety input data to network: OFF/ON for input channels n/n+1 (dual-channel complimentary)

**Figure 3 - Safety Status**



The module is designed for use in applications where the safe state is the off state.

## POINT Guard I/O Analog Input Module

The following are the safe states of the POINT Guard I/O analog input module:

- Safety input data to network in single-channel configuration: 0 (OFF)
- Safety input data to network in dual-channel equivalent configuration:
  - If a diagnostic fault occurs, the signal for the faulted channel is set to 0 (OFF).
  - If a dual-channel discrepancy fault occurs, the dual-channel inputs continue to report actual input signals.

## Safety Inputs (1734-IB8S)

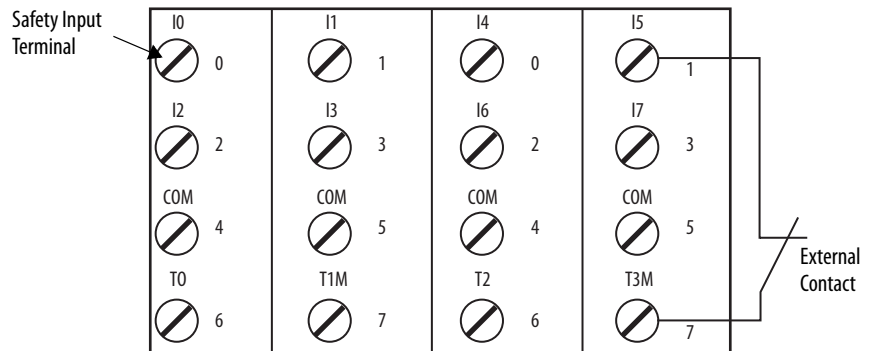
Safety inputs are used to monitor safety input devices.

### Using a Test Output with a Safety Input

A test output can be used in combination with a safety input for short circuit, cross-channel, and open-circuit fault detection. Configure the test output as a pulse test source and associate it to a specific safety input.

**TIP** The test output can also be configured as a power supply to source 24V DC to an external device, for example, a light curtain.

Figure 4 - Example Use of a POINT Guard I/O Input Module



Where:

T0 = Test Output 0

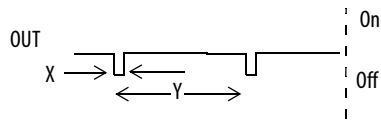
T2 = Test Output 2

I0...I7 = Safety Inputs

T1M = Test Output 1 with Muting

T3M = Test Output 3 with Muting

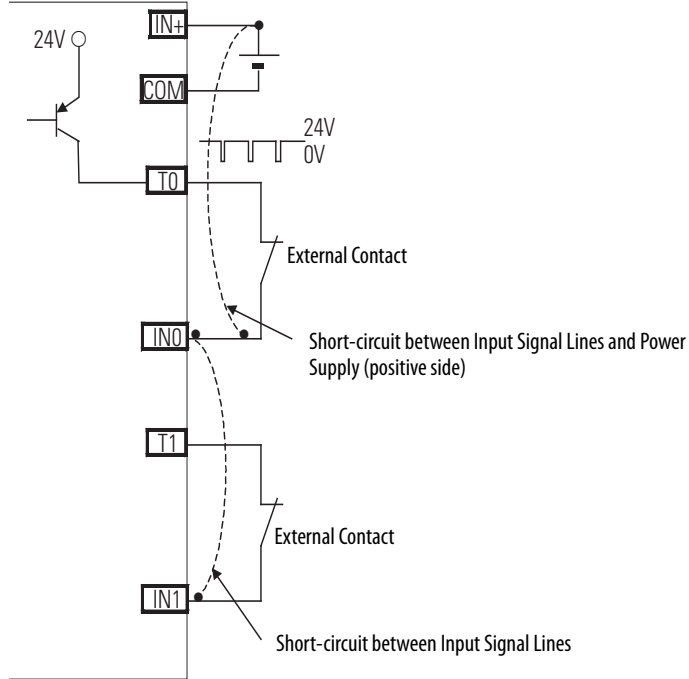
**Figure 5 - Test Pulse in a Cycle**



For the 1734-IB8S module, the pulse width (X) is typically 525  $\mu$ s; the pulse period (Y) is typically 144 ms.

When the external input contact is closed, a test pulse is output from the test output terminal to diagnose the field wiring and input circuitry. By using this function, short-circuits between inputs and 24V power, and between input signal lines and open circuits can be detected.

**Figure 6 - Short-circuit between Input Signal Lines**

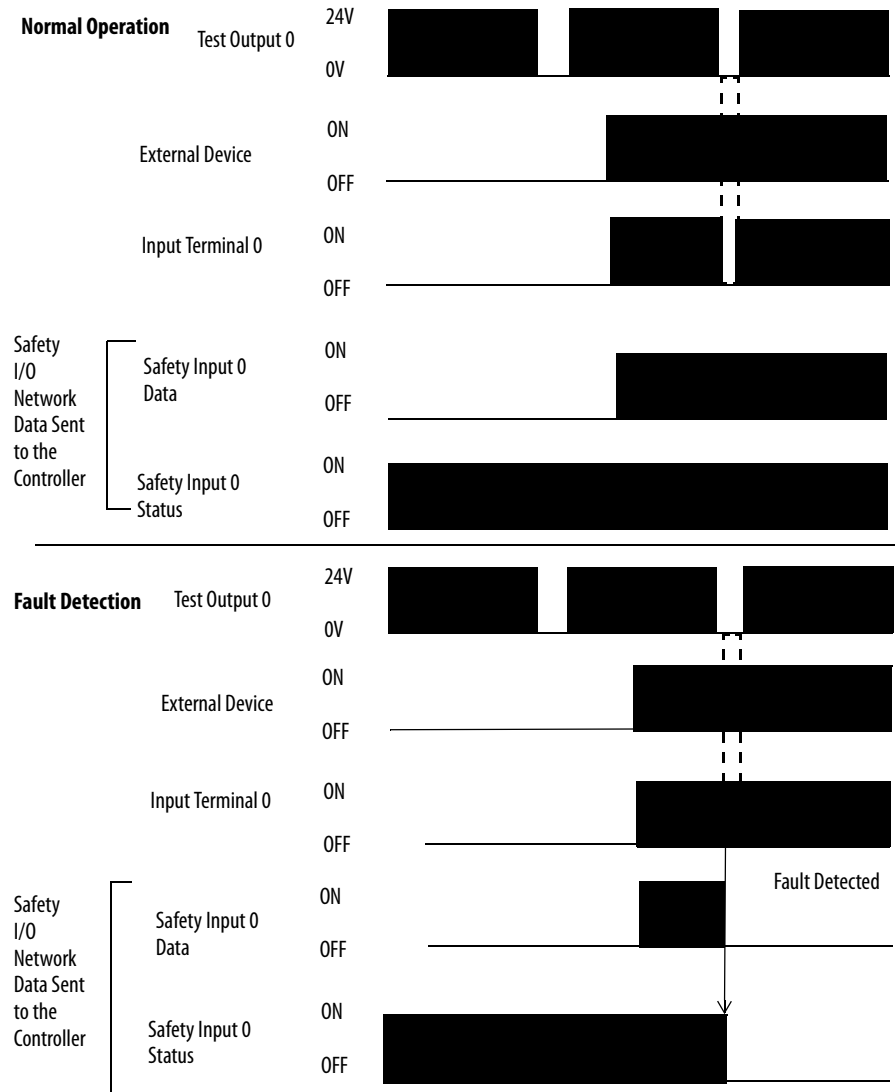


44079

## Single-channel Mode

If an error is detected, safety input data and safety input status turn off.

**Figure 7 - Normal Operation and Fault Detection (Not to Scale)**



## Dual-channel Mode and Discrepancy Time

To support dual-channel safety devices, the consistency between signals on two channels can be evaluated. Either equivalent or complementary can be selected.

If the length of a discrepancy between the channels exceeds the configured discrepancy time (0...65,530 ms in increments of 10 ms), the safety input data and the individual-safety input status turn off for both channels. In Dual-channel Complimentary mode, the safety input data goes to off/on for input channels n/n+1 respectively as described in [Table 3](#).

---

**IMPORTANT** The dual-channel function is used with two consecutive inputs that are paired together, starting at an even input number, such as inputs 0 and 1, 2 and 3.

---

**IMPORTANT** If you are using the safety application instructions with a GuardLogix® controller, set the inputs of the module inputs to Single (default). Do not use the dual-channel mode of the module, as this functionality is provided by the safety application instructions.

---

This table shows the relation between input terminal states and controller input data and status.

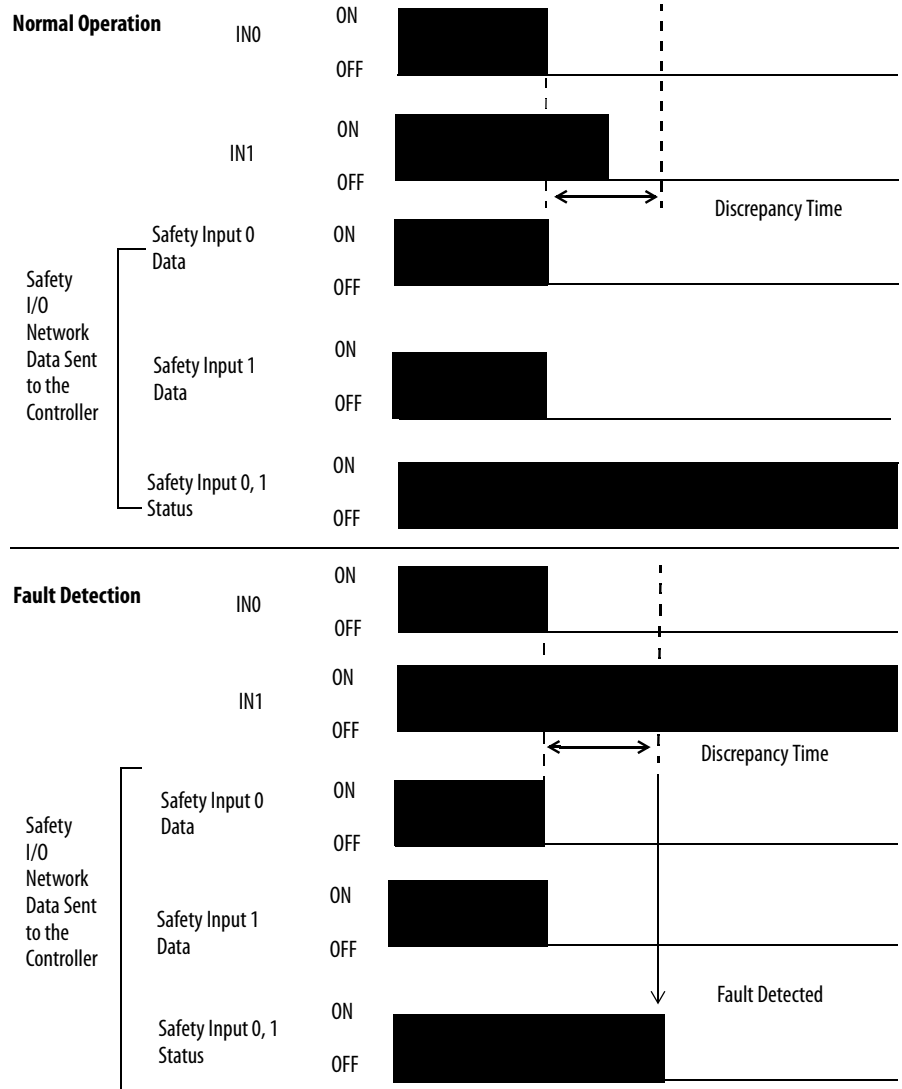
**Table 3 - Terminal Input Status and Controller I/O Data**

Dual-channel Mode	Input Terminal		Controller Input Data and Status				Dual-channel Resultant Data	Dual-channel Resultant
	IN0	IN1	Safety Input 0 Data	Safety Input 1 Data	Safety Input 0 Status	Safety Input 1 Status		
Dual-channels, Equivalent	OFF	OFF	OFF	OFF	ON	ON	OFF	Normal
	OFF	ON	OFF	OFF	OFF	OFF	OFF	Fault
	ON	OFF	OFF	OFF	OFF	OFF	OFF	Fault
	ON	ON	ON	ON	ON	ON	ON	Normal
Dual-channels, Complementary	OFF	OFF	OFF	ON	OFF	OFF	OFF	Fault
	OFF	ON	OFF	ON	ON	ON	OFF	Normal
	ON	OFF	ON	OFF	ON	ON	ON	Normal
	ON	ON	OFF	ON	OFF	OFF	OFF	Fault

## Dual-channel, Equivalent

In Equivalent mode, both inputs of a pair must be in the same (equivalent) state. When a transition occurs in one channel of the pair before the transition of the second channel of the pair, a discrepancy occurs. If the second channel transitions to the appropriate state before the discrepancy time elapsing, the inputs are considered equivalent. If the second transition does not occur before the discrepancy time elapses, the channels will fault. In the fault state, the input and status for both channels are set low (OFF). When configured as an equivalent dual pair, the data bits for both channels are sent to the controller as equivalent, both high or both low.

**Figure 8 - Equivalent, Normal Operation and Fault Detection (Not to Scale)**

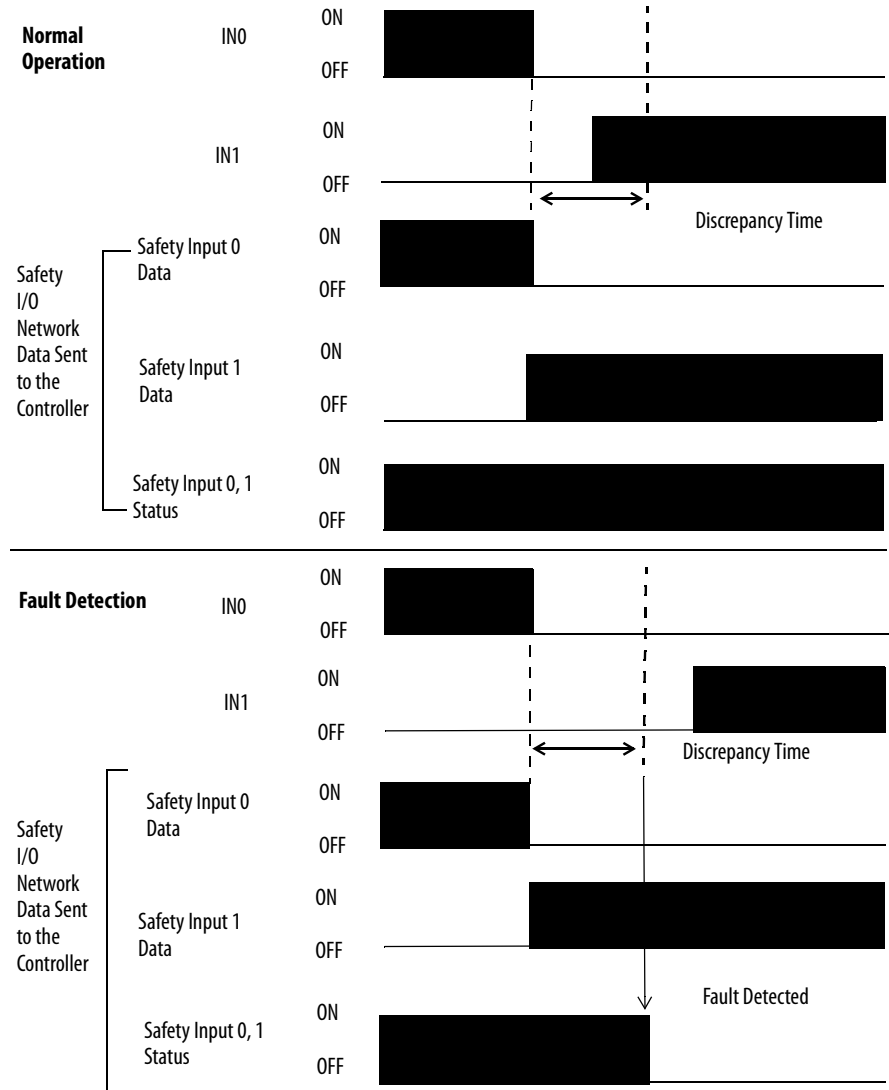


## Dual-channels, Complementary

In Complementary mode, the inputs of a pair must be in the opposite (complementary) state. When a transition occurs in one channel of the pair before the transition of the second channel of the pair, a discrepancy occurs. If the second channel transitions to the appropriate state before the discrepancy time elapsing, the inputs are considered complementary.

If the second transition does not occur before the discrepancy time elapses, the channels will fault. The fault state of complementary inputs is the even-numbered input that is turned off and the odd-numbered input turned ON. Note that if faulted, both channel status bits are set low. When configured as a complementary dual-channel pair, the data bits for both channels are sent to the controller in complementary, or opposite states.

**Figure 9 - Complementary, Normal Operation and Fault Detection (Not to Scale)**



## Safety Input Fault Recovery

If an error is detected, the safety input data remains in the OFF state. Follow this procedure to activate the safety input data again.

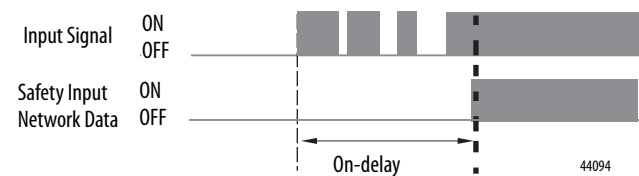
1. Remove the cause of the error.
2. Place the safety input (or safety inputs) into the safe state.
3. Allow the input-error latch time to elapse.

After these steps are completed, the I/O indicator (red) turns off.  
The input data is now active.

## Input Delays

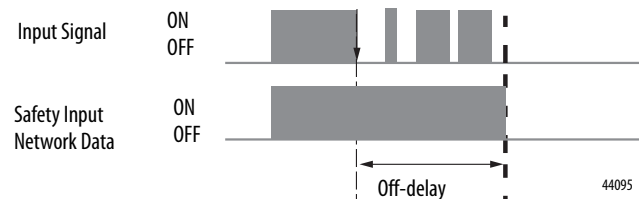
**On-delay**—An input signal is treated as Logic 0 during the on-delay time (0...126 ms, in increments of 6 ms) after the rising edge of the input contact. The input turns on only if the input contact remains on after the on-delay time has elapsed. This setting helps prevent rapid changes of the input data due to contact bounce.

**Figure 10 - On-delay**



**Off-delay**—An input signal is treated as Logic 1 during the off-delay time (0...126 ms, in increments of 6 ms) after the falling edge of the input contact. The input turns off only if the input contact remains off after the off delay time has elapsed. This setting helps prevent rapid changes of the input data due to contact bounce.

**Figure 11 - Off-delay**





## Safety Analog Inputs (1734-IE4S)

Safety analog-input channels can be configured for current, voltage, or tachometer inputs, and for input type: single-channel or dual-channel equivalent.

---

**IMPORTANT** If you are using the module with a GuardLogix® controller, set the inputs of the module to Single (default). Do not use the dual-channel equivalent mode of the modules with the GuardLogix dual channel safety application instructions, as dual-channel functionality is provided by the GuardLogix instructions.

---

### Input Range

You configure the module for the following voltage or current input ranges, or for tachometer inputs.

- $\pm 10V$
- $\pm 5V$
- 0...5V
- 0...10V
- 4...20 mA
- 0...20 mA
- Tachometer (1...1000 Hz)

---

**IMPORTANT** When  $\pm 10V$  and  $\pm 5V$  ranges are selected, you must make sure that a broken-wire condition is not a safety hazard. A broken wire causes the analog value to transition to 0, which is within the valid input range. Therefore, status bits do not indicate the broken-wire condition.

---

### Scaling

The module converts input signals to the engineering units specified when you configure the module. You set the High Engineering value and the Low Engineering value to which the module scales the input signal before sending the data to the application program of the controller.

---

**EXAMPLE** The module is configured as follows:

- Input Range = 0...10V
- Low Engineering value = 0
- High Engineering value = 10,000

If the incoming signal is 1V, the data is 1000.  
If the incoming signal is 5.5V, the data is 5500.

---

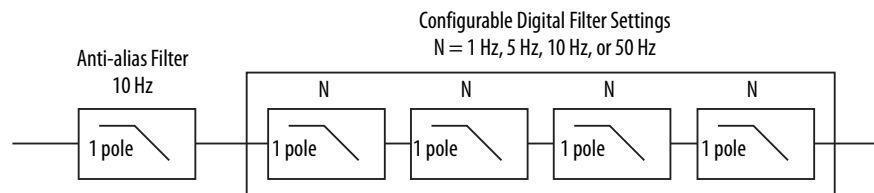
## Digital Input Filter

A single-pole, anti-aliasing filter of 10 Hz is followed by a four-pole digital filter. Choose from the following available corner frequencies.

- 1 Hz
- 5 Hz
- 10 Hz
- 50 Hz

The default input filter setting is 1 Hz.

**Figure 12 - Filter Operation**



The filter setting affects the step response of the module. See the technical specifications for the 1734-IE4S module, that start on [page 170](#).

For the analog input modes, the input filter settings set the low-pass filter to filter out noise that can be present on the signal. In Tachometer mode, the input filter removes noise that can be present on the calculated frequency, effectively changing how rapidly the tachometer frequency changes to provide a value with less jitter.

## Sensor Power Supply

You can configure the module to supply power to the connected sensors, or you can supply power to the sensors from an external power supply. To comply with UL restrictions, field power and connected devices must be powered by one, Class 2-complaint power supply.

We recommend that you configure the module to supply power to the sensors. This configurations lets the module detect if a sensor loses power, if the sensor is drawing too much power, or if there is a short in the power wiring to the sensor.

At powerup or after a reconfiguration, each sensor power supply is tested by being turned on for 500 ms.

When a channel is configured for module sensor power, a sensor power diagnostic is executed on that channel at powerup. The diagnostic is used to make sure that the sensors are not drawing over- or under-current and that channel-to-channel shorts are not present.

**TIP** When a sensor power over-current condition occurs, it can take as much as 15 seconds longer than the configured latch time for channel status to recover after the over-current condition is cleared.

---

**IMPORTANT** If you use an external power supply, you must monitor the system for the following:

- The supply voltage must be within the operating range of the sensor.
- The current draw of the sensors must not be over- or under-current, which could indicate a problem with the components of the sensor.
- Channel-to-channel shorts must be detected, if they occur.

---

## Channel Offset

You can configure an offset when differences in the sensors nominal input signals would otherwise exceed the desired discrepancy deadband. Use the Channel Offset if you are using two sensors of different types to measure the same variable. Sensors from two different vendors potentially give slightly differing data values for a given temperature or pressure. Use the Channel Offset to bring the data values back together. You can also use the Channel Offset with two identical sensors that are physically offset from each other.

The channel offset is applied before the channel discrepancy is evaluated.

**TIP** The Channel Offset is applied only during the evaluation of discrepancy between two channels that are configured for Dual Channel and is not applied to any of the Process Alarms. Therefore, if you are using two sensors to measure the same process variable, and these sensors read different values, you potentially need to set the Process Alarms to different values based on the sensor readings.

## Process Alarms

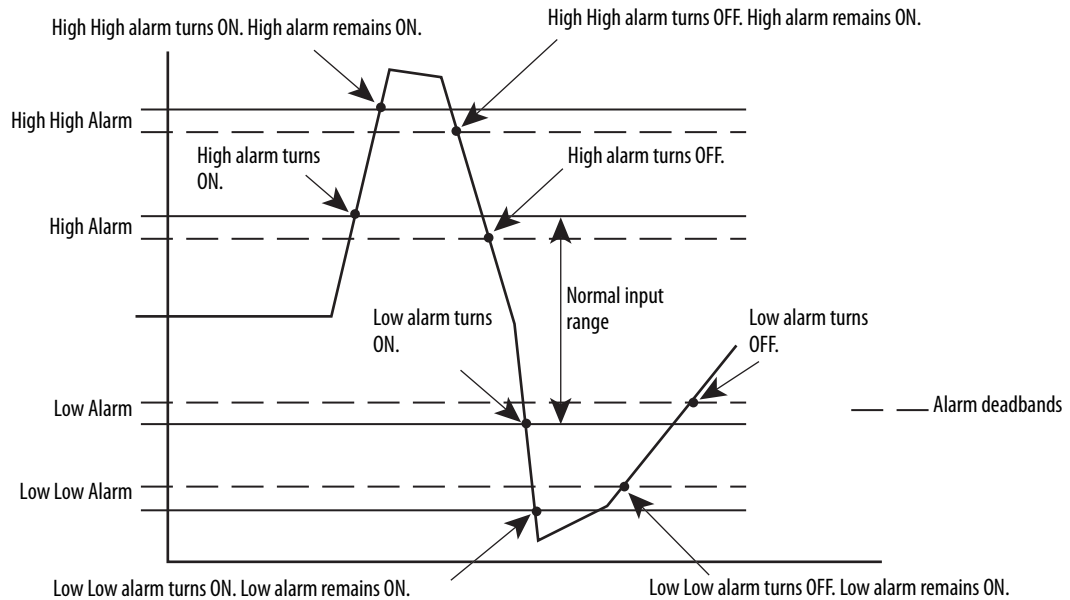
Process alarms alert you when an analog input value has exceeded the configured high or low limits for each channel. Process alarms are set at four configurable trigger points.

- High High alarm
- High alarm
- Low alarm
- Low Low alarm

You can configure a tolerance range, called a deadband, to work with process alarms. This deadband lets the process alarm status bit remain set, despite the alarm condition disappearing, as long as the data remains within the deadband of the process alarm.

**IMPORTANT** If you are using the safety application instructions with a GuardLogix controller, do not use the process alarm of the module. Instead, perform analog range checking in your application logic.

**Figure 13 - Alarms**



## Using a Single-channel Sensor

You must address the following requirements to meet SIL 3 with a single-channel sensor.

- The module's  $\pm 10V$  and  $\pm 5V$  analog input modes must not be used for SIL 3 with a single-channel sensor because 0V falls within the valid input range. Therefore, a stuck at ground fault cannot be detected.
- In a single-channel sensor system, you must use other methods to make sure a channel-to-channel short cannot occur because these faults cannot be detected.
- If you are using a 3-wire sensor, you must verify its behavior to make sure that if it loses its ground connection, the signal is 0 (safe state) at the module input when the fault occurs.

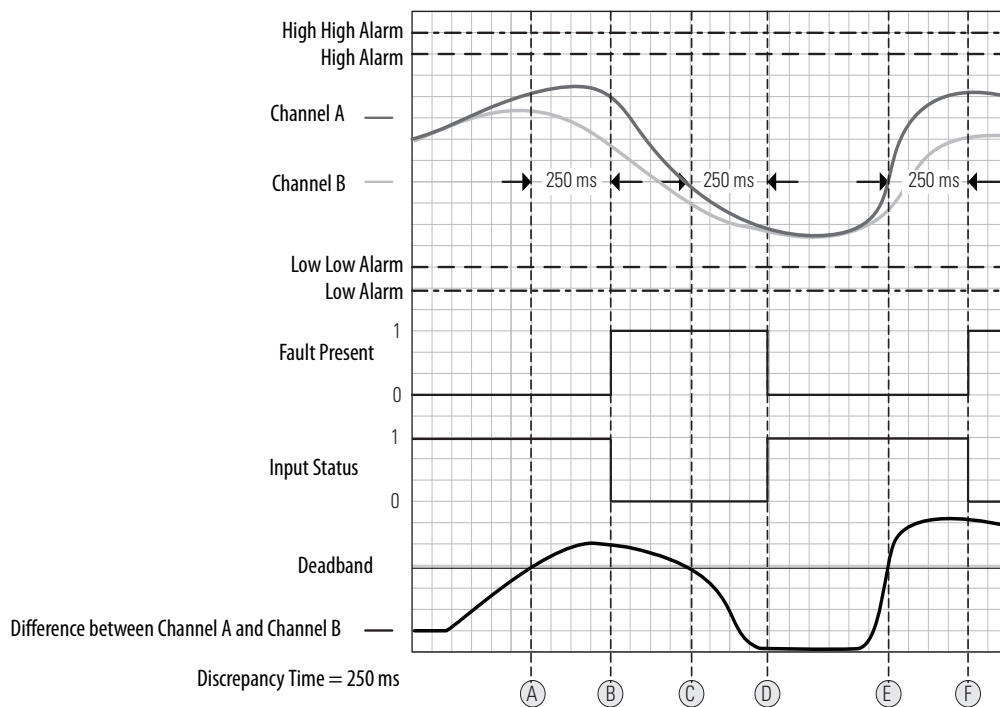
## Dual-channel Equivalent Mode

**IMPORTANT** If you are using the module with a GuardLogix controller, set the inputs of the module to Single (default). Do not use the dual-channel mode of the module as this functionality is provided by the GuardLogix safety application instructions.

The 1734-IE4S module supports Dual-channel Equivalent mode. In Dual-channel Equivalent mode, the values of both inputs of a pair must be within a configured tolerance range (discrepancy deadband). If the difference between the channel values exceeds the deadband for longer than the configured discrepancy time, a discrepancy fault is declared. When a dual-channel discrepancy fault occurs, the input status values for both channels are set low (off) and the actual input values are reported. The fault is cleared when the difference between the values of the channel fall back within the discrepancy deadband tolerance range for the discrepancy time.

[Figure 14](#) illustrates module operation in dual-channel equivalent mode. At A, the difference between the channel values exceeds the discrepancy deadband tolerance range and the discrepancy timer starts. When the timer expires at B, a dual-channel discrepancy fault occurs and the inputs status bits are set low. At C, the values fall back within the discrepancy deadband and the discrepancy timer starts again. When the timer expires at D, and the values are still within the discrepancy deadband, the fault is cleared. At E, the difference between the channels exceeds the discrepancy deadband and the discrepancy timer starts. A discrepancy fault occurs again at F, when the timer expires and the difference between the channel values remains greater than the discrepancy deadband.

**Figure 14 - Timing Diagram**



## Tachometer Mode

In Tachometer mode, the module measures digital pulses between 0 and 24V DC and converts them into a frequency or pulses per second. Therefore, you can use 24V DC proximity sensors or 5V DC encoders, for example. The Tachometer function does not sense direction, so using a differential encoder does not yield direction data. Tachometer mode could be used, for example, to measure rotational speed of an axis that is connected to a gear.

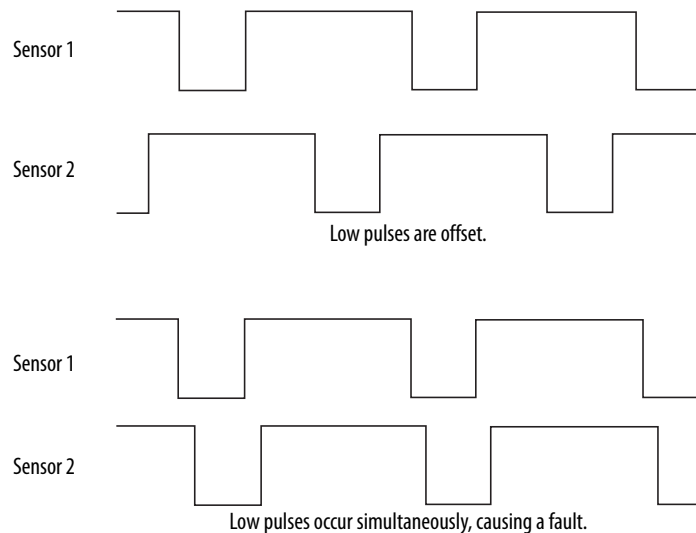
Tachometer mode can operate as SIL 2 single-channel. SIL 3 is achievable by using two sensors, the dual-low detection parameter, and user program logic. Safety reaction time is dependent on the signal frequency.

---

**IMPORTANT** When using two sensors in a dual-channel configuration, position the sensors to make sure that the low pulses occur at different times. If you have configured the module for dual low detection and both sensors are low simultaneously, a fault is declared.

---

**Figure 15 - Sensor Pulses in Dual-channel Configuration**

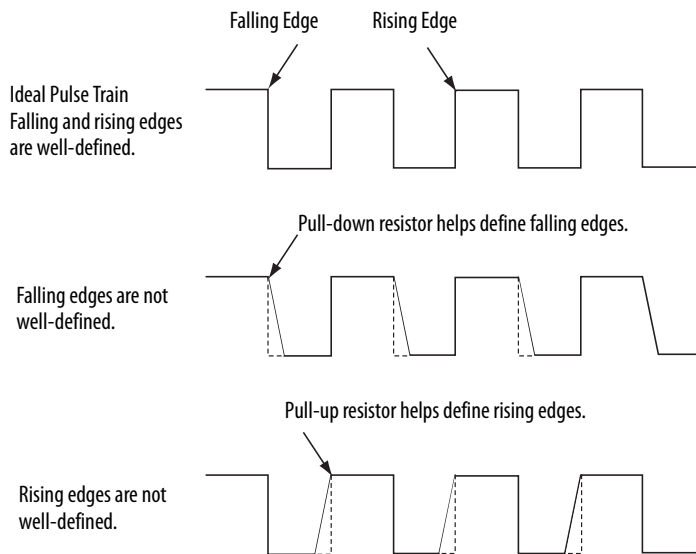


### Signal Measurement

The edge-to-edge time of the pulse determines the frequency of the signal in pulses per second. The frequency range is 1 Hz...1 kHz.

In Tachometer mode, you define how the signal is measured, either on the falling (non-inverted) or rising (inverted) edge. For NPN-style sensors (sensor sinks), use falling edge. For PNP-style sensors (sensor sources), use rising edge. Depending on your application, you need to install an appropriately sized pull-up resistor for falling-edge signal measurements or a pull-down resistor for rising-edge signal measurements.

**Figure 16 - Pulse Trains**



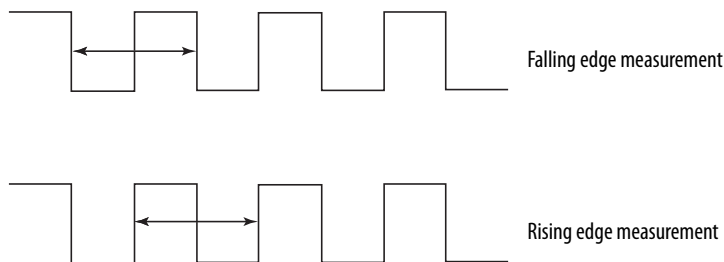
*Off and On Signal Levels*

You configure the Off and On levels, in 1V increments, for the signal. When selecting these levels, assume a tolerance of at least  $\pm 0.5V$ . For example, if you set the On Level to 10V, you can expect the module to recognize a signal between 9.5 and 10.5V as On. While the accuracy of the module when measuring the analog signal is good, Tachometer mode emphasizes a wider voltage range and speed to be able to measure pulse widths accurately.

Also consider the variance of the voltage output from your sensor when making the On and Off Level settings. If possible, we recommend selecting On Levels that are 2V below and Off Levels that are 2V above the actual thresholds of the expected output voltage level of your device.

*Determining Frequency in Pulses per Second*

The edge-to-edge time of either the falling or rising edge of the pulse determines the frequency in pulses per second.



One pulse, by itself, does not generate a non-zero frequency. To report a frequency of 1 Hz, two falling or rising edge pulses must be detected within 1 second. The module reports 0 Hz until 1 Hz is detected. For example, if a falling or rising edge is not detected for 1.02 seconds after the previous edge, the module reports 0 Hz.

### Overfrequency Bit Operation

When the frequency exceeds 1 kHz, the module reports a data value of 1 kHz, sets the Overfrequency status bit to 0, and latches it. While the Overfrequency bit is set to 0, you must use an alternate method to monitor the frequency of the system because the value reported by the module is latched at 1 kHz. Once you have verified that the frequency is lower than 1 kHz, you can reset the Overfrequency condition by setting the Reset Tach bit, which lets the module begin measuring the frequency of field pulses again.

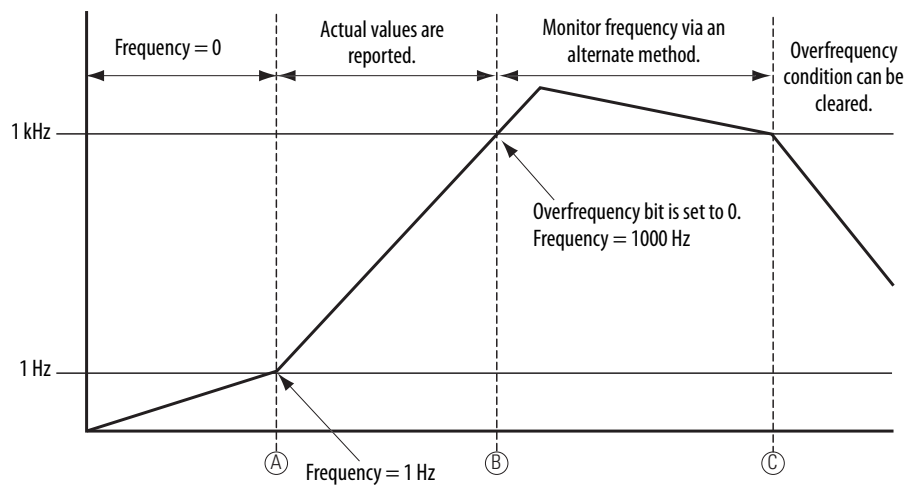
If you set the Reset Tach bit while the frequency is still above 1 kHz, the Tachometer Overfrequency bit transitions to 1 (within range) momentarily. However, as soon as the module begins to measure pulses, it detects another overfrequency condition and immediately set the Tachometer Overfrequency bit to 0 again. The Reset Tach bit is edge-sensitive.



**ATTENTION:** Before resetting the Overfrequency condition, you must use another method to verify that the actual frequency is lower than 1 kHz.

See [Output Assemblies on page 212](#) for more information on resetting the Overfrequency bit.

**Figure 17 - Overfrequency Operation**



In [Figure 17](#), the module reports a frequency of 0 Hz until the frequency of the system reaches 1 Hz at A, when the module begins reporting the actual value. At B, the frequency exceeds 1 kHz, the Overfrequency bit is set to 0, and the module continues to report a data value of 1 kHz. Between B and C, you must monitor the frequency by an alternate method because the value reported by the module is not always accurate. After C, the Overfrequency condition can be cleared, provided you have used an alternate method to verify that the actual frequency is below 1 kHz.

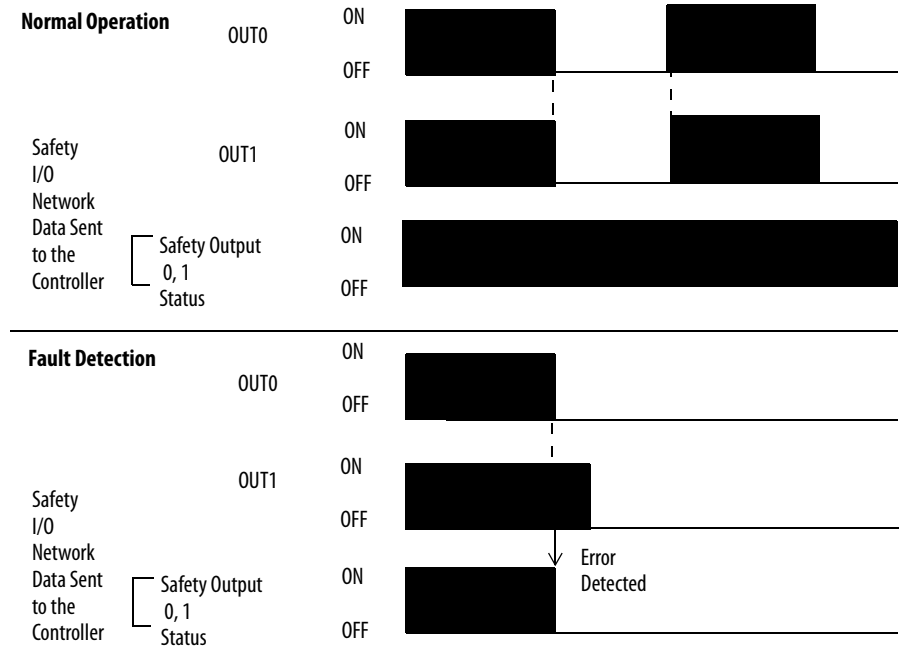




## Dual-channel Mode

When the data of both channels is in the on state, and neither channel has a fault, the outputs are turned on. The status is normal. If a fault is detected on one channel, the safety output data and individual safety output status turn off for both channels.

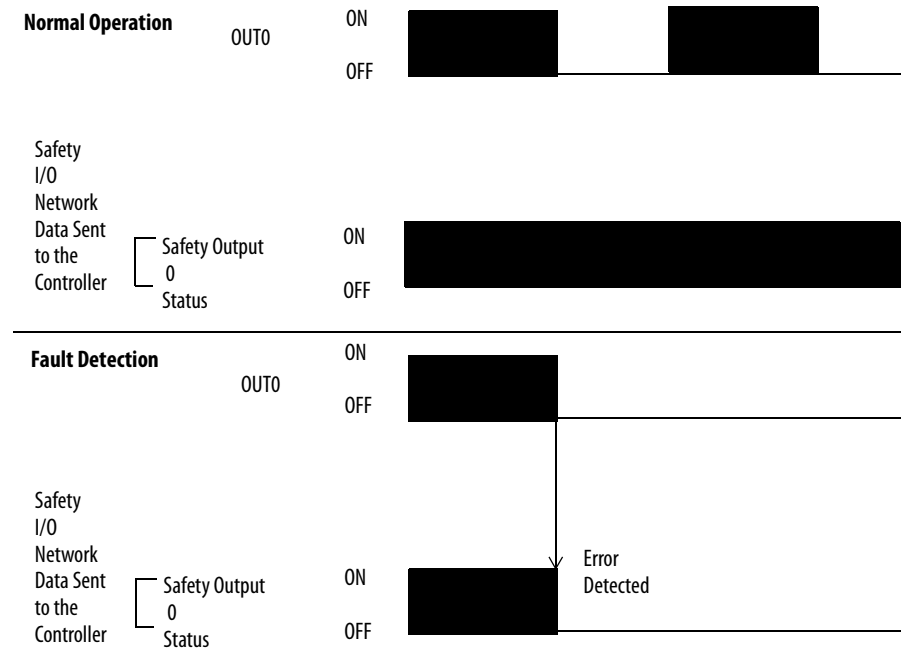
**Figure 19 - Dual-channel Setting (Not to Scale)**



## Single-channel Mode, 1734-0B8S Only

When the data of the channel is in the on state, and does not have a fault, the output is turned on. The status is normal. If a fault is detected on the channel, the safety output data and individual safety output status turn off.

**Figure 20 - Single-channel Setting (not to scale)**



## Safety Output Fault Recovery

If a fault is detected, the safety outputs are switched off and remain in the off state. Follow this procedure to activate the safety output data again.

1. Remove the cause of the error.
2. Command the safety output (or safety outputs) into the safe state.
3. Allow the output-error latch time to elapse.

After these steps are completed, the I/O indicator (red) turns off. The output data can now be controlled.

---

**IMPORTANT** Stuck high faults require a module power reset to clear the error.

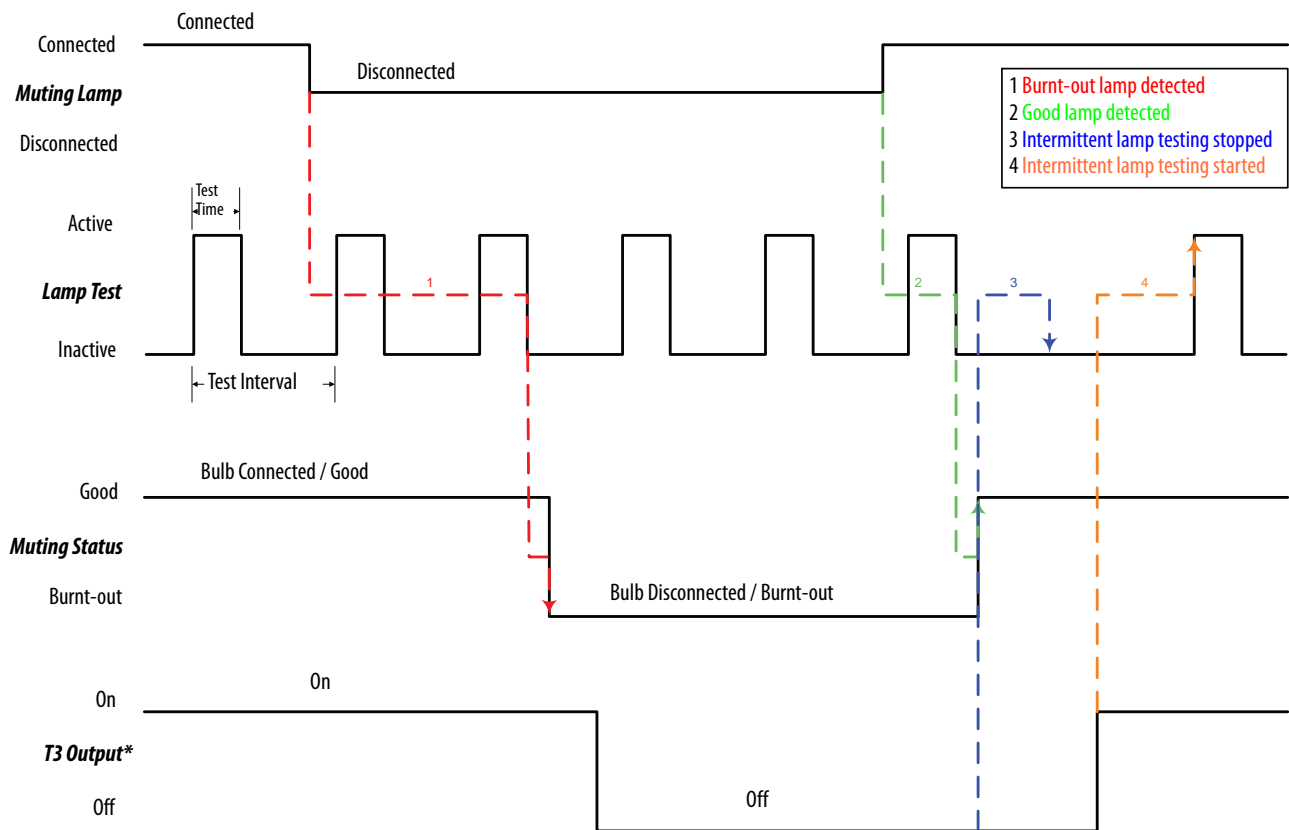
---

## Muting Lamp Operation (1734-IB8S)

Beginning with Firmware Revision 1.002, the operation of the muting status bits for the test outputs T1 and T3 has changed. Test outputs T1 and T3 are controlled by your PLC processor program to illuminate a muting lamp. Muting lamp status is monitored with a test that runs periodically during every test interval to detect a burned-out lamp. The test runs repeatedly when the test output is commanded on. Figure 21 explains how muting lamp operation, status, and fault detection are monitored.

**TIP** The lamp test interval is 3 seconds. Two consecutive failed lamp tests are required to declare a burned-out lamp condition. The lamp test does not always run immediately after the test output is energized. It starts at the next 3-second interval. To allow time for two consecutive test intervals, program a minimum Test Output On Time of 6 seconds.

Figure 21 - Muting Lamp Timing Diagram



\* Note: Output controlled by User program, not by Muting Status bit.

Table 4 shows the expected behavior of the muting status for test outputs T1 and T3. Keep these points in mind as well:

- When power is applied to the 1734-IB8S module, and T1 or T3 remains commanded off, the muting status defaults to on.

This bit operation is designed to help prevent erroneous muting instruction faults from the GuardLogix controller. This bit status is not always the true indication of a burned-out lamp.

---

**IMPORTANT** Before checking the state of the corresponding muting status, be sure that the test output is commanded on. Once the test output is commanded on, a maximum time of 6 seconds is required for the module to detect a burned-out lamp.

---

- If a muting lamp circuit is open when power is applied to the module, the condition is detected when the test output is commanded on.
- When a lamp burns out and is replaced, the fault (muting status bit) returns to the normal condition, independent of the state of the test output.

**Table 4 - Muting Status Bit Operation**

Test Output Commanded State	Lamp Condition	Muting Status Bit	Description
ON	Bad (open circuit)	0	Repair lamp.
ON	Good	1	Normal condition. Lamp is operating properly.
OFF	Bad (open circuit)	0	If lamp remains OFF after T1/T3 output cycled, repair lamp.
OFF	Good	1	Normal condition.

## I/O Status Data

In addition to I/O data, the module provides status data for monitoring the I/O circuits. The status includes diagnostic data that the controllers can read with 1 = ON/Normal and 0 = OFF/Fault/Alarm.

## Digital I/O Status Data

The following data is monitored:

- Individual Point Input Status
- Combined Input Status
- Individual Point Output Status
- Combined Output Status
- Individual Test Output Status
- Individual Output Monitor (actual ON/OFF state of the outputs)

Individual Point status indicates whether each safety input, safety output, or test output is normal (normal: ON, faulted: OFF). For fatal errors, communication connections can be broken, so the status data cannot be read. Status bits are OFF in the controller data table when the connection is lost.

Combined status is provided by an AND of the status of all safety inputs or all safety outputs. When all inputs or outputs are normal, the respective combined status is ON. When one or more of them has an error, the respective combined status is OFF. This status is known as the combined safety input status or combined safety output status.

## Analog I/O Status Data

Individual input status indicates whether each analog input point is normal (ON) or faulted (OFF). In addition, the following diagnostic data is monitored:

- User 24V Supply Overrange or Underrange
- Sensor Power Overcurrent or Undercurrent
- Channel Signal Overrange or Underrange
- Broken Wire Detected (4...20 mA current mode)
- Single-channel Discrepancy Error (channel fault)

In SIL 2 or SIL 3 operation, a single-channel discrepancy error occurs when both measurements (internal to the module) of the same input signal are not within tolerance. If a single-channel discrepancy occurs, indicating a problem with the module, input status is set to zero and a zero input value is reported for that channel.

- SIL 3 Dual-channel Discrepancy Error (channel fault)
- Alarms
  - High High and Low Low Alarm Overrange or Underrange
  - High and Low Alarms Overrange or Underrange
  - Dual-channel Tachometer Dual Low Inputs Detected
  - Tachometer Frequency Overrange or Underrange

The alarm status is reported in the Alarm Status attribute for each channel.

## Guidelines for Placing Power Supplies and Modules in a System

Topic	Page
Choosing a Power Supply	43
Power Supply Examples	45
Placing Series A Digital and Analog Modules	47

### Choosing a Power Supply

The POINTBus™ backplane includes a 5V communication bus and field power bus that get their power from a communication adapter or expansion power supplies. All POINT I/O™ modules are powered from the POINTBus backplane by either the adapter or expansion power supply. POINT I/O adapters have built-in power supplies. Use the information and examples in this chapter to determine if you need an expansion power supply in your system.



**ATTENTION:** To comply with the CE Low Voltage Directive (LVD), this equipment, and all connected I/O, must be powered from a safety extra low voltage (SELV) or protected extra low voltage (PELV) compliant source.

To comply with UL restrictions, field power and connected devices must be powered from one Class 2-compliant power supply.

The 1734-OBV2S module requires the use of SELV 150VA Max. supply.

#### TIP

The following Rockwell Automation® 1606 power supplies are SELV- and PELV-compliant, and they meet the isolation and output hold-off time requirements of the SmartGuard™ 600 controller:

- 1606-XLP30E
- 1606-XLP50E
- 1606-XLP50EZ
- 1606-XLP72E
- 1606-XLP95E
- 1606-XLDNET4

Follow the safety precautions that are listed in [Chapter 1](#) and the wiring guidelines that are described in [Chapter 4](#) before connecting a power supply to the system.

To choose which types of power supplies meet your requirements, you **must** consider the power consumption requirements for the 5V and 24V bus when designing a POINTBus backplane.

Choose from these power supplies for the POINTBus backplane and field power:

- Use the 1734-EP24DC expansion power supply to provide an additional 10 A of 24V DC field power and provide an additional 1.3 A of 5V current to the I/O modules to the right of the power supply.
- Use the 1734-FPD field power distributor to provide an additional 10 A of 24V DC field power, and to pass through all POINT I/O backplane signals including the 5V bus supplied to the left, without providing **additional** POINTBus backplane power. This action lets you isolate field power segments.
- Use the 1734-EPAC expansion power supply (for standard I/O modules) to provide an additional 10 A of 120/240V AC field power and provide an additional 1.3 A of 5V current to the I/O modules to the right of the power supply.

---

**IMPORTANT** If you use the 1734-EPAC expansion power supply to the left of the POINT Guard I/O™ modules, you must use a 1734-FPD field power distributor or 1734-EP24DC expansion power supply. These distributors are used to isolate POINT Guard I/O field power from the AC field supply.

5V POINTBus power is required to establish and maintain communication (connection) between the module and the controller.

---

See the POINT I/O Selection Guide, publication [1734-SG001](#), for more information on compatible power supplies.



## Power Supply Examples

Use these valid power-supply example configurations to help you understand various combinations of power supplies that can fit your system:

- [Example 1: Isolating Field Power Segments on page 45](#)
- [Example 2: POINT Guard I/O Used with AC I/O Modules on page 46](#)

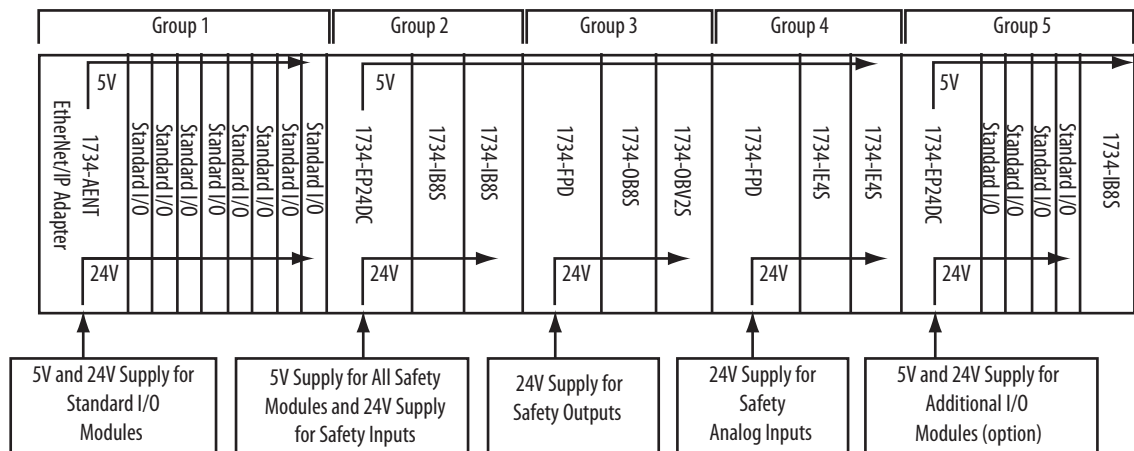
These examples are for illustrative purposes only, to help you understand various power sourcing concepts.

**IMPORTANT**

- You must define the requirements for segmenting field and bus power in your application.
- POINT Guard I/O does not require separate field-bus power usage, that is, separate power supplies for the 1734-IB8S, 1734-OB8S, 1734-OBV2S, or 1734-IE4S modules. This step is optional.
- POINT Guard I/O does not require separate POINTBus (communication) power-supply usage, which separates it from any other POINT I/O modules, except when additional POINTBus power is required.
- Do not apply AC voltage to POINT Guard I/O modules.

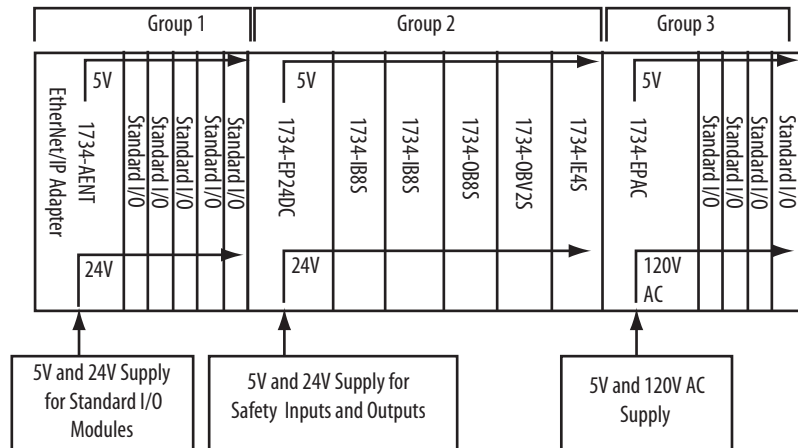
### Example 1: Isolating Field Power Segments

This power supply example uses a 1734-EP24DC expansion power supply and 1734-FPD field power distributor to illustrate mixing standard POINT I/O and safety POINT Guard I/O modules. The example illustrates the mixing standard while creating separate groups for input and output modules, along with digital and analog modules.



### Example 2: POINT Guard I/O Used with AC I/O Modules

This power supply example uses 1734-EP24DC and 1734-EPAC expansion power supplies to illustrate mixing standard POINT I/O and safety POINT Guard I/O modules, while creating a separate power group for AC I/O modules.

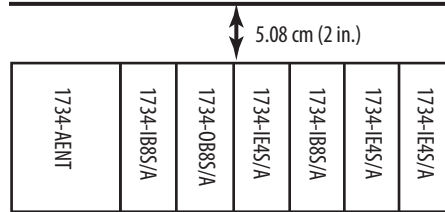


## Placing Series A Digital and Analog Modules

Always install modules in accordance with their specified operating temperature ratings, as listed in [Appendix](#), and provide a minimum of 5.08 cm (2 in.) clearance above the modules.

- Limit ambient temperature operation to 40 °C (104°F) if Series A POINT Guard I/O modules are used without 1734-CTM spacer modules.

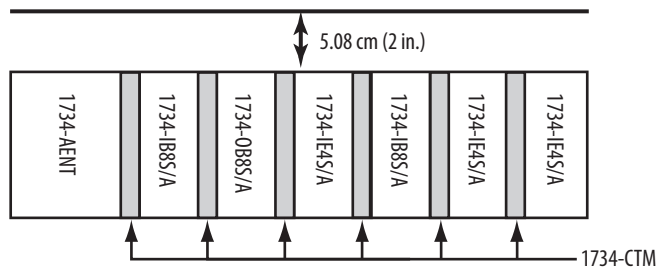
**Figure 22 - Placing Series A Digital Modules for up to 40 °C (104 °F) Operation**



- In any system where you have any Series A POINT Guard I/O modules, use a 1734-CTM spacer between every POINT Guard I/O module with ambient operation between 40 °C (104 °F) and 55 °C (131 °F).

Insert a 1734-CTM module next to each standard I/O module (gray) if the thermal dissipation specification of that module is more than 1 W.

**Figure 23 - Placing Series A Digital and Analog Modules for Operation from 40 °C (104 °F)...55°C (131°F) max.**



- When using Series A POINT Guard I/O modules in your system limit the power supply to 24V DC maximum, to limit the Series A POINT Guard I/O thermal dissipation of the module.

See [System Temperature Derating When a 1734-IE4S Module Is Used on page 194](#) for more information.



**ATTENTION:** Vertical orientation requires careful attention to design details and panel layout so that all modules in the stack must operate within their rated operating temperature range.

For Vertical installations, be sure that 1734-CTM spacer modules are installed next to any Series A POINT Guard IO modules operating above 40 °C (104 °F) ambient.

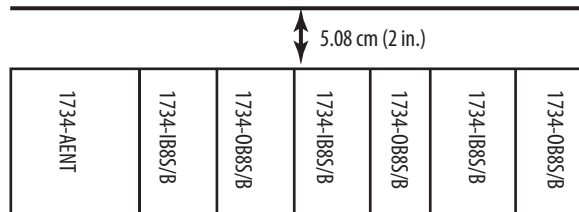
## Placing Series B Digital Modules

Always install modules in accordance with their specified operating temperature ratings, as listed in [Appendix C](#), and provide a minimum of 5.08 cm (2 in.) clearance above the modules.

When used in a system that contains only Series B Guard I/O modules, series B Guard I/O modules are used without 1734-CTM spacer modules in environments with ambient operation up to 55 °C (131 °F).

See [Technical Specifications for Series B Modules on page 185](#) for Series B POINT Guard I/O module derating requirements for every module with ambient operation between 40 °C (104 °F) and 55 °C (131 °F).

**Figure 24 - Placing Series B Digital Modules for up to 55 °C (131 °F) Operation**

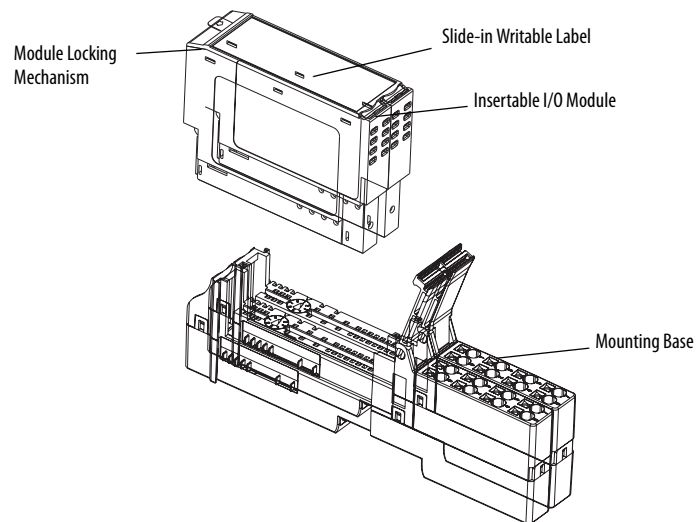


**ATTENTION:** Vertical orientation requires careful attention to design details and panel layout so that all modules in the stack operate within their rated operating temperature range.

## Install the Module

Topic	Page
Precautions	50
Install the Mounting Base	53
Connect the Module to the Mounting Base	55
Connect the Removable Terminal Block	56
Remove a Mounting Base	57
Wire Modules	57
Connection Details	61
Wiring Examples	63

**Figure 25 - POINT Guard I/O™ Modules**



31867-M

## Precautions

Follow these precautions for use.



**ATTENTION:** This equipment is certified for use only within the surrounding air temperature range of -20...+55 °C (-4...+131 °F). The equipment must not be used outside of this range.

---



**ATTENTION:** Use only a soft dry anti-static cloth to wipe down equipment. Do not use any cleaning agents.

---



**ATTENTION: Electrical Safety Considerations**

Power to this equipment and all connected I/O must be supplied from a source compliant with the following:


- Class 2 approved to UL1310, does **not** apply to the 1734-0BV2S module.
  - Limited Voltage Limited Current Supply compliant with UL508, does **not** apply to the 1734-0BV2S module.
  - Limited Energy Maximum 150VA, applies **ONLY** to 1734-0BV2S.
  - SELV source approved to EN/IEC60950-1, EN/IEC61010-2-201 or EN/IEC62368-1 (ES1)
  - PELV source approved to EN/IEC60950-1, EN/IEC61010-2-201 or EN/IEC62368-1 (ES1)
- 



**ATTENTION:** if you use multiple power sources when using the 1734-IE4S module, do not exceed the specified isolation voltage.

---

## European Hazardous Location Approval

The following applies to products marked  II3G:

- Are Equipment Group II, Equipment Category 3, and comply with the Essential Health and Safety Requirements relating to the design and construction of such equipment given in Annex II to Directive 2014/34/EU. See the EC Declaration of Conformity at: <http://www.rockwellautomation.com/products/certification> for details.
- The type of protection is "Ex nA IIC T4 Gc" according to EN 60079-15.
- Comply to Standards EN 60079-0:2012+A11:2013, EN 60079-15:2010, reference certificate number DEMKO09ATEX0919970X.
- Are intended for use in areas in which explosive atmospheres caused by gases, vapors, mists, or air are unlikely to occur, or are likely to occur only infrequently and for short periods. Such locations correspond to Zone 2 classification according to ATEX directive 2014/34/EU.
- May have catalog numbers followed by a "K" to indicate a conformal coating option.





---


### **WARNING: Special Conditions for Safe Use:**

- This equipment must be used within its specified ratings as defined by Rockwell Automation.
  - This equipment shall be mounted in an ATEX Zone 2 certified enclosure with a minimum ingress protection rating of at least IP54 (in accordance with EN 60079-15) and used in an environment of not more than Pollution Degree 2 (as defined in EN 60664-1) when applied in Zone 2 environments. The enclosure must be accessible only by the use of a tool.
  - Provision must be made to prevent the rated voltage from being exceeded by transient disturbances of more than 140% of the peak rated voltage when applied in Zone 2 environments.
  - The instructions in the user manual shall be observed.
  - This equipment must be used only with ATEX-certified Rockwell Automation terminal bases.
  - Secure any external connections that mate to this equipment by using screws, sliding latches, threaded connectors, or other means provided with this product.
  - Do not disconnect equipment unless power has been removed or the area is known to be nonhazardous.
-

### North American Hazardous Location Approval

The following information applies when operating this equipment in hazardous locations.	Informations sur l'utilisation de cet équipement en environnements dangereux.
<p>Products marked "CL I, DIV 2, GP A, B, C, D" are suitable for use in Class I Division 2 Groups A, B, C, D, Hazardous Locations and nonhazardous locations only. Each product is supplied with markings on the rating nameplate indicating the hazardous location temperature code. When combining products within a system, the most adverse temperature code (lowest "T" number) may be used to help determine the overall temperature code of the system. Combinations of equipment in your system are subject to investigation by the local Authority Having Jurisdiction at the time of installation.</p>	<p>Les produits marqués "CL I, DIV 2, GP A, B, C, D" ne conviennent qu'à une utilisation en environnements de Classe I Division 2 Groupes A, B, C, D dangereux et non dangereux. Chaque produit est livré avec des marquages sur sa plaque d'identification qui indiquent le code de température pour les environnements dangereux. Lorsque plusieurs produits sont combinés dans un système, le code de température le plus défavorable (code de température le plus faible) peut être utilisé pour déterminer le code de température global du système. Les combinaisons d'équipements dans le système sont sujettes à inspection par les autorités locales qualifiées au moment de l'installation.</p>
<div style="display: flex; align-items: center;">  <div> <p><b>EXPLOSION HAZARD -</b></p> <ul style="list-style-type: none"> <li>• Do not disconnect equipment unless power has been removed or the area is known to be nonhazardous.</li> <li>• Do not disconnect connections to this equipment unless power has been removed or the area is known to be nonhazardous. Secure any external connections that mate to this equipment by using screws, sliding latches, threaded connectors, or other means provided with this product.</li> <li>• Substitution of components may impair suitability for Class I, Division 2.</li> <li>• If this product contains batteries, they must only be changed in an area known to be nonhazardous.</li> </ul> </div> </div>	<div style="display: flex; align-items: center;">  <div> <p><b>RISQUE D'EXPLOSION –</b></p> <ul style="list-style-type: none"> <li>• Couper le courant ou s'assurer que l'environnement est classé non dangereux avant de débrancher l'équipement.</li> <li>• Couper le courant ou s'assurer que l'environnement est classé non dangereux avant de débrancher les connecteurs. Fixer tous les connecteurs externes reliés à cet équipement à l'aide de vis, loquets coulissants, connecteurs filetés ou autres moyens fournis avec ce produit.</li> <li>• La substitution de composants peut rendre cet équipement inadapté à une utilisation en environnement de Classe I, Division 2.</li> <li>• S'assurer que l'environnement est classé non dangereux avant de changer les piles.</li> </ul> </div> </div>

### Environment and Enclosure

	<p><b>ATTENTION:</b> This equipment is intended for use in a Pollution Degree 2 industrial environment, in overvoltage Category II applications (as defined in IEC 60664-1), at altitudes up to 2000 m (6562 ft) without derating.</p> <p>This equipment is not intended for use in residential environments and may not provide adequate protection to radio communication services in such environments.</p> <p>This equipment is supplied as open-type equipment for indoor use. It must be mounted within an enclosure that is suitably designed for those specific environmental conditions that will be present and appropriately designed to prevent personal injury resulting from accessibility to live parts. The enclosure must have suitable flame-retardant properties to prevent or minimize the spread of flame, complying with a flame spread rating of 5VA or be approved for the application if non-metallic. The interior of the enclosure must be accessible only by the use of a tool. Subsequent sections of this publication may contain more information regarding specific enclosure type ratings that are required to comply with certain product safety certifications.</p> <p>In addition to this publication, see the following:</p> <ul style="list-style-type: none"> <li>• Industrial Automation Wiring and Grounding Guidelines, publication <a href="#">1770-4.1</a>, for more installation requirements.</li> <li>• NEMA Standard 250 and IEC 60529, as applicable, for explanations of the degrees of protection provided by enclosures.</li> </ul>
---	---



---

## Prevent Electrostatic Discharge

---



**ATTENTION:** This equipment is sensitive to electrostatic discharge, which can cause internal damage and affect normal operation. Follow these guidelines when you handle this equipment:

- Touch a grounded object to discharge potential static.
  - Wear an approved grounding wriststrap.
  - Do not touch connectors or pins on component boards.
  - Do not touch circuit components inside the equipment.
  - Use a static-safe workstation, if available.
  - Store the equipment in appropriate static-safe packaging when not in use.
- 

## Mount the Module

---

**IMPORTANT** Follow these guidelines when installing a module:

- Use the module in an environment that is within the general specifications.
  - Use the module in an enclosure rated at IP54 (IEC60529) or higher.
  - Use DIN rail that is 35 mm (1.38 in.) wide to mount the terminal base in the control panel.
  - Place other heat sources an appropriate distance away from the module to maintain ambient temperatures around the module below specified maximums.
  - You can mount your module horizontally or vertically.
- 

To mount the module, you must install the mounting base, connect the module to the mounting base, and then connect the removable terminal block.

## Install the Mounting Base

The mounting base assembly (catalog number 1734-TB or 1734-TBS) consists of a mounting base and a removable terminal block. Alternatively, you can use the POINT I/O™ one-piece mounting base (catalog number 1734-TOP, 1734-TOPS, 1734-TOP3, or 1734-TOP3S).

---

**IMPORTANT** You need two mounting base assemblies for each POINT Guard I/O™ module. Do not use 1734-TB3 or 1734-TB3S mounting base assemblies.

---

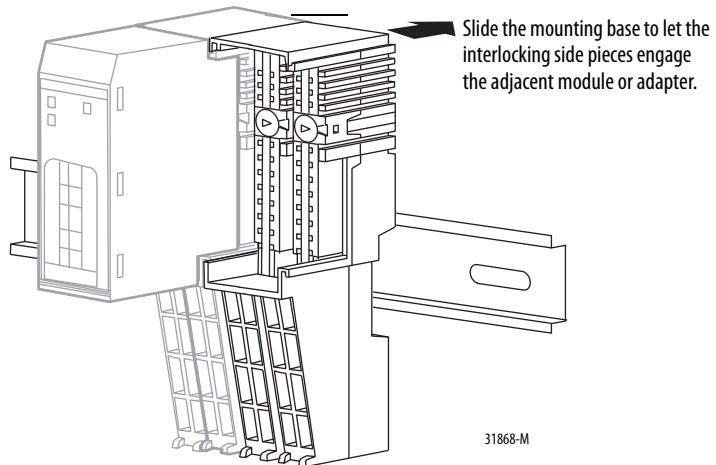


**WARNING:** For ATEX applications, Do not exceed 31.2V DC maximum.

---

Follow these steps to install the mounting base.

1. Position the mounting base as shown in the illustration below step 2.
2. Slide the mounting base down, allowing the interlocking side pieces to engage the adjacent module, power supply, or adapter.



3. Press firmly to seat the mounting base on the DIN rail until the mounting base snaps into place.

**TIP** In high vibration environments, install slide locks helps prevent the movement of the mounting base along the DIN rail.

See the terminal base installation instructions for detailed information on installation and removal. Always follow instructions and torque specifications in terminal base installation instructions. See [Additional Resources on page 10](#) for terminal base installation publications.

## Connect the Module to the Mounting Base

Install the module before or after installing the mounting base.



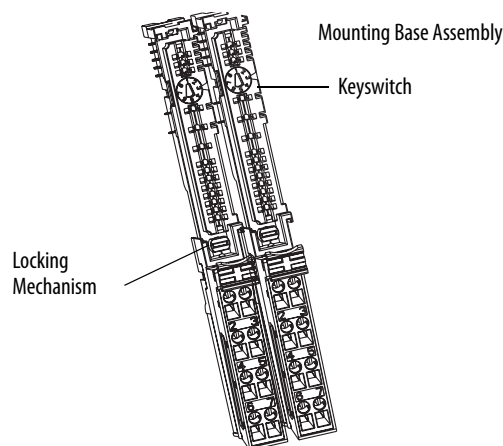
**WARNING:** When you insert or remove the module while backplane power is on, an electric arc can occur. This arc could cause an explosion in hazardous location installations. Be sure that power is removed or the area is nonhazardous before proceeding.

Repeated electric arcs causes excessive wear to contacts on both the module and its mating connector. Worn contacts can create electrical resistance that can affect module operation.

1. With a screwdriver, rotate the keyswitches on the mounting base clockwise until the number required for the type of module aligns with the notch in the base.

Monitor which mounting base gets installed on the left and right of each module.

Cat. No.	Key 1 (Left)	Key 2 (Right)
1734-IB8S	8	1
1734-OB8S	8	2
1734-OBV2S	8	2
1734-IE4S	8	3



2. Verify the DIN rail (orange) lock screw is in the horizontal position, note that you cannot insert the module if the mounting-base locking mechanism is unlocked.
3. Insert the module straight down into the two side-by-side mounting bases, press to secure, and lock the module into place.

## Connect the Removable Terminal Block

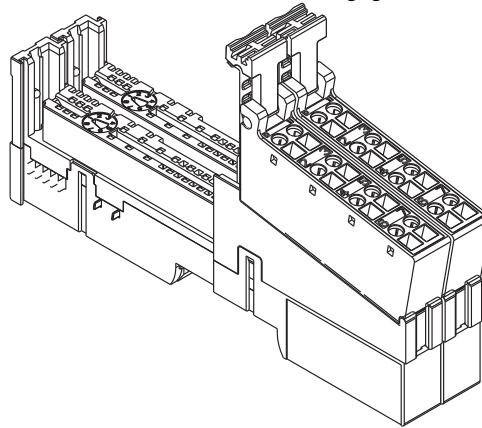
If a removable terminal block (RTB) is supplied with your mounting base assembly, you must remove it by pulling up on the RTB handle. This action lets you remove and replace the base as necessary without removing any of the wiring.



**WARNING:** When you connect or disconnect the removable terminal block (RTB) with field-side power applied, an electric arc can occur. This arc could cause an explosion in hazardous location installations. Be sure that power is removed or the area is nonhazardous before proceeding.

To reinsert the RTB, follow these directions.

1. Insert the RTB end opposite the handle into the base unit, note that this end has a curved section that engages with the mounting base.



2. Rotate the terminal block into the mounting base until it locks itself in place.
3. If an I/O module is installed, snap the RTB handle into place on the module.

## Remove a Mounting Base

To remove a mounting base, you must remove any installed module and the module that is installed in the base to the right. If the mounting base has a removable terminal base (RTB), unlatch the RTB handle on the I/O module and pull on the handle to remove the RTB.



**WARNING:** When you insert or remove the module while backplane power is on, an electric arc can occur. This arc could cause an explosion in hazardous location installations. Be sure to remove power or that the area is nonhazardous before proceeding.

1. To remove it from the base, pull up on the I/O module.
2. Remove the module to the right of the base you are removing, note that the interlocking portion of the base sits under the adjacent module.
3. Use a screwdriver to rotate the orange DIN rail lock screw on the mounting base to a vertical position, which releases the locking mechanism.
4. Lift the mounting base off the DIN rail.

## Wire Modules

Follow these guidelines when wiring the modules.

- Do not route communication, input, or output wiring with conduit that contains high voltage. See the Industrial Automation Wiring and Grounding Guidelines, publication [1770-4.1](#).
- Wire correctly after confirming the signal names of all terminals.
- Use shielded cable for analog and tachometer inputs.
- When using the sensor power supply on the 1734-IE4S module, do not connect an external power supply to the sensor.
- If you use the 1734-IE4S sensor power supply of the module to power your input devices, you are responsible for verifying that your application operates properly with the diagnostic features of this output.
- Tighten screws for communication and I/O connectors correctly.
- When using analog inputs, wire only to voltage or only to current inputs, not both. If you mix input types, it can induce noise on the input measurements.



---

**ATTENTION:** Wire the POINT Guard I/O modules properly so that 24V DC line does not touch the safety outputs accidentally or unintentionally.

Do not connect loads beyond the rated value to safety outputs.

Wire conductors correctly and verify operation of the module before placing the system into operation. Incorrect wiring can lead to loss of safety function.

Do not apply DC voltages that exceed the rated voltages to the module.

Do not connect a power source to the sensor power supply in the 1734-IE4S module or you could blow an internal fuse. When an internal fuse is blown, the module is inoperative.

Disconnect the module from the power supply before wiring. If wiring is performed while power is supplied, devices that are connected to the module can operate unexpectedly.

---



---

**WARNING:** If you connect or disconnect wiring while the field-side power is on, an electric arc can occur. This arc could cause an explosion in hazardous location installations. Be sure that power is removed or the area is nonhazardous before proceeding.

This equipment must be used within its specified ratings that Rockwell Automation has defined.

---



---

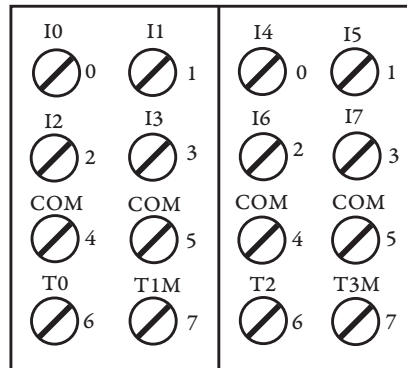
**ATTENTION:** This product is grounded through the DIN rail to chassis ground. Use zinc plated chromate-passivated steel DIN rail to assure proper grounding. The use of other DIN rail materials (for example, aluminum or plastic) that can corrode, oxidize, or are poor conductors, can result in improper or intermittent grounding. Secure DIN rail to mounting surface approximately every 200 mm (7.8 in.) and use end-anchors appropriately. Be sure to ground the DIN rail properly. Refer to Industrial Automation Wiring and Grounding Guidelines, Rockwell Automation publication [1770-4.1](#), for more information.

---

## Terminal Layout

Figure 26, Figure 27, Figure 28, and Figure 29 on page 60 show the field wiring connections for the POINT Guard I/O modules.

**Figure 26 - 1734-IB8S Field Connections**

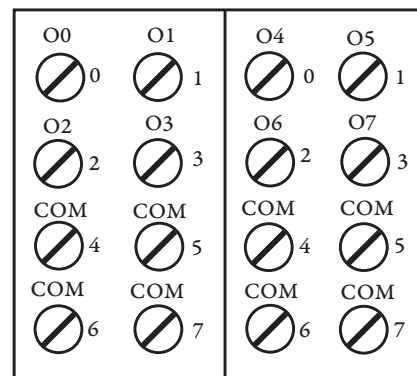


1734-TOP and 1734-TB Bases Shown

Where:

- T0 = Test Output 0
- T1M = Test Output 1 with Muting
- T2 = Test Output 2
- T3M = Test Output 3 with Muting
- I0...I7 = Inputs 0...7
- COM = Supply Common

**Figure 27 - 1734-OB8S Field Connections**

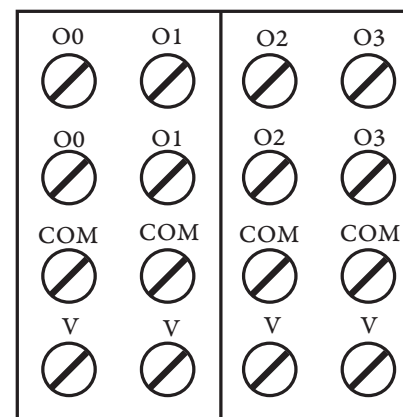


1734-TOP and 1734-TB Bases Shown

Where:

- O0...O7 = Safety Outputs 0...7
- COM = Supply Common

**Figure 28 - 1734-OBV2S Field Connections**

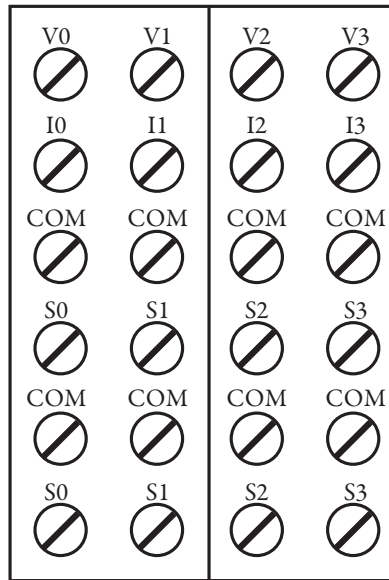


1734-TOP and 1734-TB Bases Shown

Where:

- Channels O0 and O1 = safety output bipolar pair
- Channels O2 and O3 = safety output bipolar pair
- Channels O0 and O2 = sourcing outputs
- Channels O1 and O3 = sinking outputs
- COM = Sensor Power supply common
- V = Sensor Power supply

Figure 29 - 1734-IE45 Field Connections



1734-TOP3 Base Shown

Where:

V0...V3 = Voltage inputs 0...3

I0...I3 = Current inputs 0...3

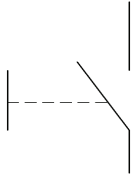
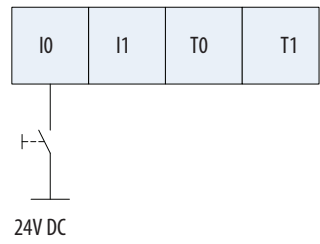
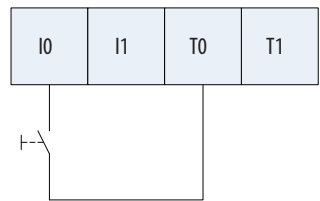
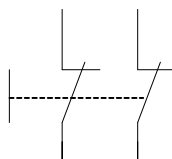
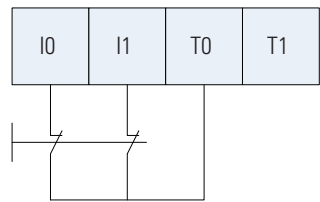
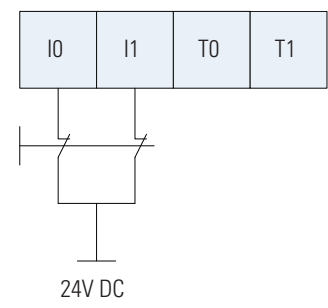
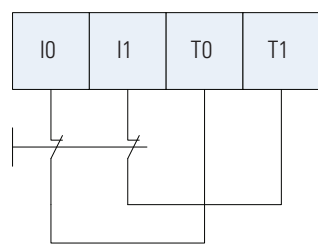
COM = Supply Common

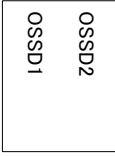
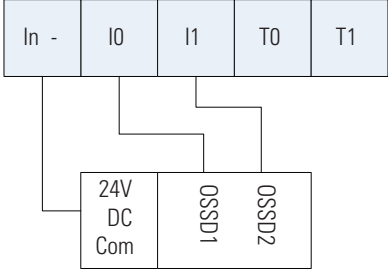
S0...S3 = Sensor power terminals



## Connection Details

See the tables that show input device connection methods and their safety categories.

Connected Device	Test Pulse from Test Output	Connection	Schematic Diagram	Safety Category
Push Button 	No	Connect the push button between 24V DC and I0.		1
	Yes	Connect the push button between I0 and T0. T0 must be configured as test pulse.		2
Emergency stop button Door monitoring switch 	No	Connect the devices between T0 and I0 and I1, note that T0 is configured for 24V power supply.		3
		Connect the devices between 24V DC and I0 and I1.		
	Yes	Connect the device between I0 and T0, and I1 and T1.		4

Connected Device	Test Pulse from Test Output	Connection	Schematic Diagram	Safety Category
Light Curtain  	Yes	Connect the OSSD1 and OSSD2 to I0 and I1, respectively. Connect the 24V power supply commons.		3 or 4 based on light curtain being used

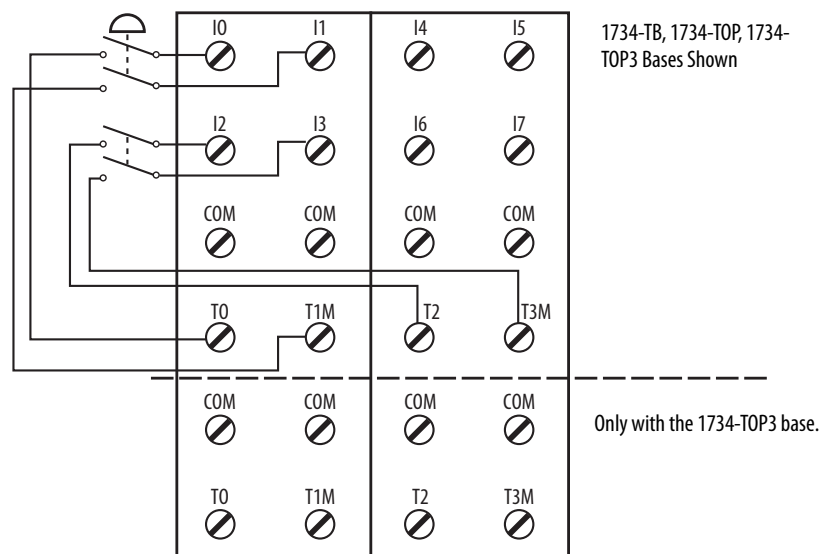
## Wiring Examples

Read this section for examples of wiring by application. See catalog number details for the appropriate module.

### Emergency Stop Dual-channel Devices

This example shows wiring and controller configuration when using a digital POINT Guard I/O module with an emergency stop button and gate monitoring switch that have dual-channel contacts. When used in combination with the programs in a safety controller, this wiring is safety Category 4 (emergency stop button) and safety Category 3 (gate monitoring switch).

**Figure 30 - 1734-IB85 POINT Guard I/O Module Wiring (dual-channel contacts)**



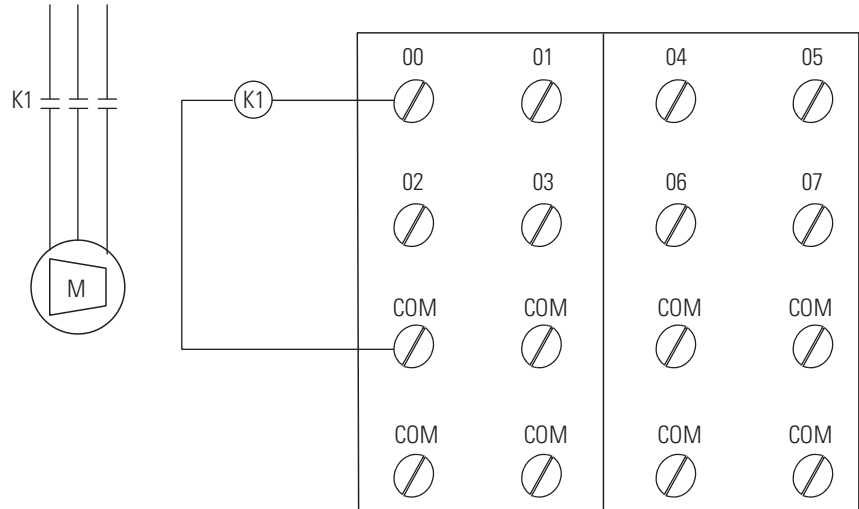
Controller Configuration	Parameter Name	Configuration Setting
Safety Input 0	Safety Input 0 Channel Mode	Test Pulse from Test Output
	Safety Input 0 Test Source	Test Output 0
	Dual-channel Safety Input 0/1 Mode	Dual-channel Equivalent
	Dual-channel Safety Input 0/1 Discrepancy Time	100 ms (application dependent)
Safety Input 1	Safety Input 1 Channel Mode	Test Pulse from Test Output
	Safety Input 1 Test Source	Test Output 1
Safety Input 2	Safety Input 2 Channel Mode	Safety Input
	Safety Input 2 Test Source	Test Output 2
	Dual-channel Safety Input 2/3 Mode	Dual-channel Equivalent
Safety Input 3	Safety Input 3 Channel Mode	Safety Input
	Safety Input 3 Test Source	Test Output 3
Test Output 0	Test Output 0 Mode	Pulse Test Output
Test Output 1	Test Output 1 Mode	Pulse Test Output
Test Output 2	Test Output 2 Mode	Power Supply Output
Test Output 3	Test Output 3 Mode	Power Supply Output

## Single-channel Safety Contactor

This example shows wiring and controller configuration when using a 1734-OB8S digital POINT Guard I/O module with one safety contactor.

When used in combination with the programs of the safety controller, this circuit configuration is safety Category 2.

**Figure 31 - 1734-OB8S POINT Guard I/O Module Wiring (single safety contact)**



Where:  
 00...07 = Safety Outputs  
 COM = Common

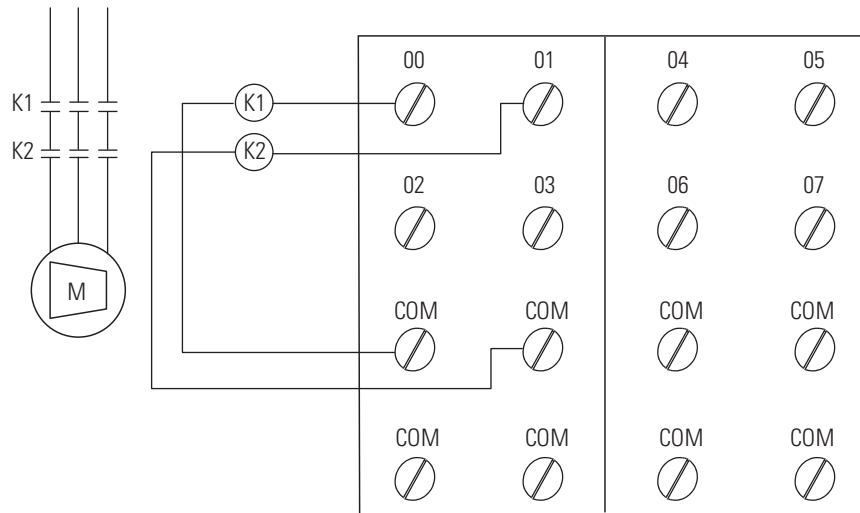
Controller Configuration	Parameter Name	Configuration Setting
Safety Output 0	Safety Output 0 Point Mode	Safety Pulse Test
	Point Operation Type	Single Channel

## Dual-channel Safety Contactors

This example shows wiring and controller configuration when using a 1734-OB8S digital POINT Guard I/O module with redundant safety contactors.

When used in combination with the programs of the safety controller, this circuit configuration is safety Category 4. Additional wiring, such as monitoring feedback, can be required to achieve safety Category 4.

**Figure 32 - 1734-OB8S POINT Guard I/O Module Wiring (redundant safety contacts)**



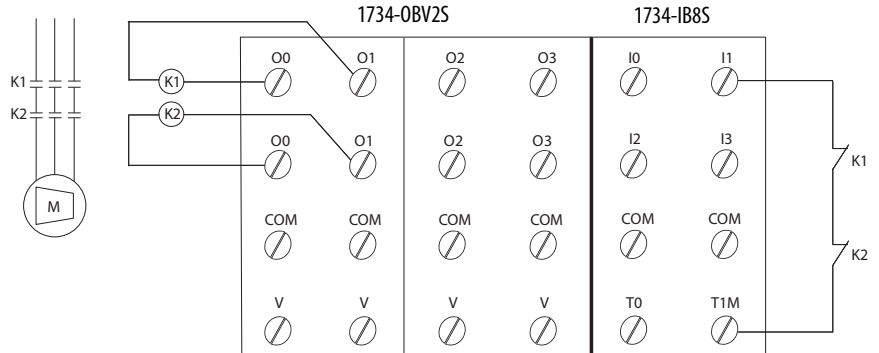
Where:  
 00...07 = Safety Outputs  
 COM = Common

Controller Configuration	Parameter Name	Configuration Setting
Safety Output 0	Safety Output 0 Point Mode	Safety Pulse Test
	Point Operation Type	Dual-channel
Safety Output 1	Safety Output 1 Point Mode	Safety Pulse Test

## Bipolar Safety Outputs

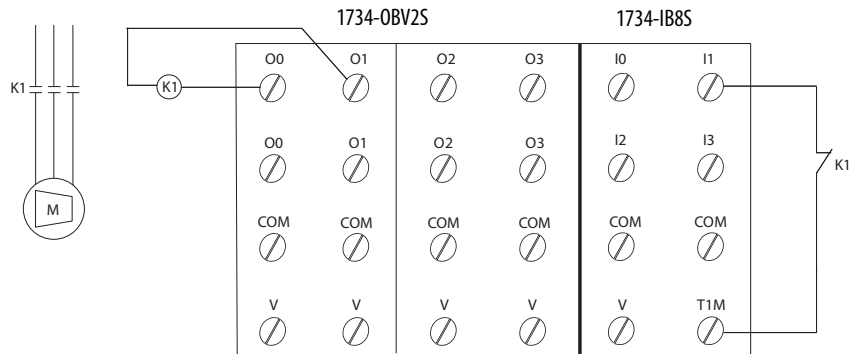
These examples show how to wire a 1734-OBV2S output module with an input module to meet PLe and PLd safety requirements.

**Figure 33 - 1734-OBV2S Dual Safety Output Wiring - PLe**



Controller Configuration	Parameter Name	Configuration Setting
Safety output 0	Safety output 0 point mode	Safety pulse test
Safety output 1	Safety output 1 point mode	Safety pulse test
Safety input 1	Safety input 1 point operation type	Single
	Safety input 1 point mode	Safety pulse test
	Safety input 1 test source	1
Test output 1	Test output 1 point mode	Pulse test

**Figure 34 - 1734-OBV2S Dual Safety Output Wiring - PLd**



Controller Configuration	Parameter Name	Configuration Setting
Safety output 0	Safety output 0 point mode	Safety pulse test
Safety output 1	Safety output 1 point mode	Safety pulse test
Safety input 1	Safety input 1 point operation type	Single
	Safety input 1 point mode	Safety pulse test
	Safety input 1 test source	1
Test output 1	Test output 1 point mode	Pulse test

## Safety Analog Input Wiring

The following sections contain important guidelines for wiring safety analog inputs and wiring examples for the 1734-IE4S module.

### *Guidelines for Wiring Safety Analog Inputs*

Follow these guidelines when wiring your safety analog inputs.

For eight terminal connections, either the 1734-TOP or 1734-TB terminal base can be used. For all 12 terminal connections, only the 1734-TOP3 base can be used. When using a 1734-TOP3 base, both of the COM terminals and both of the Sensor Power terminals for each channel are internally connected. The FE terminal connection that is shown on the diagrams represents a grounding lug on the panel or terminal connection to the DIN rail.

If the sensor has a digital output for use with Tachometer mode, it must be either a push-pull type output or have appropriate pull-up or pull-down resistors for NPN or PNP sensors. The analog input module does not provide the low impedance of these pull-up or pull-down resistors.

See [Figure 47](#) and [Figure 48 on page 74](#) for examples.

---

**IMPORTANT** You must verify the behavior of your 3-wire sensor to make sure that if it loses its ground connection, the signal is 0 (safe state) at the module input when the fault occurs.

---

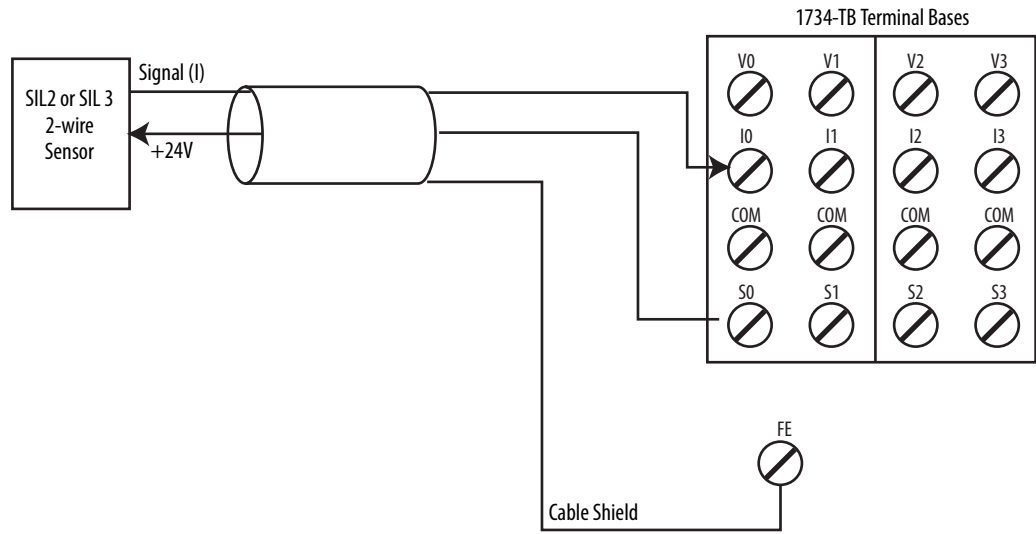
---

**IMPORTANT** To obtain SIL 3, Cat. 3 or Cat.4, you must make sure that the analog input signals cannot short together or that the two sensors are installed to provide signals that are offset from one another. When the module is configured as the source for sensor power, a short-circuit is detected at powerup (Cat. 2). However, when an external power supply is used, another means must detect this fault.

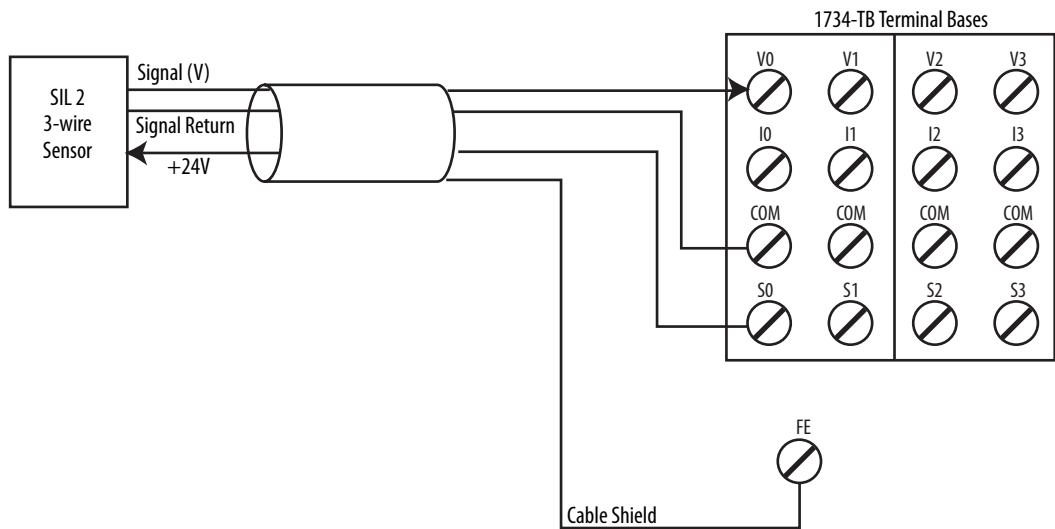
---

*Safety Analog Input Wiring Examples*

**Figure 35 - 2-wire Current (4...20 mA) Sensor (SIL2 or SIL 3)**



**Figure 36 - 3-wire Voltage or Tachometer Sensor (SIL 2)**



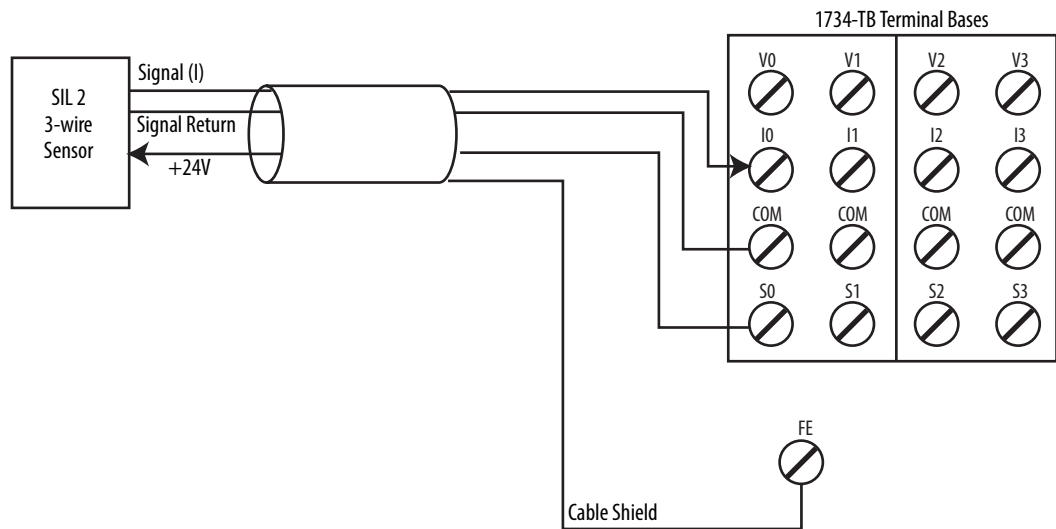
For analog voltage-output sensors, the signal levels for operation for the application must be outside the signal level when the signal is not present, for example, when the wire is broken.

See [Figure 47](#) and [Figure 48 on page 74](#) for tachometer wiring detail.

Follow the [Guidelines for Wiring Safety Analog Inputs on page 67](#).

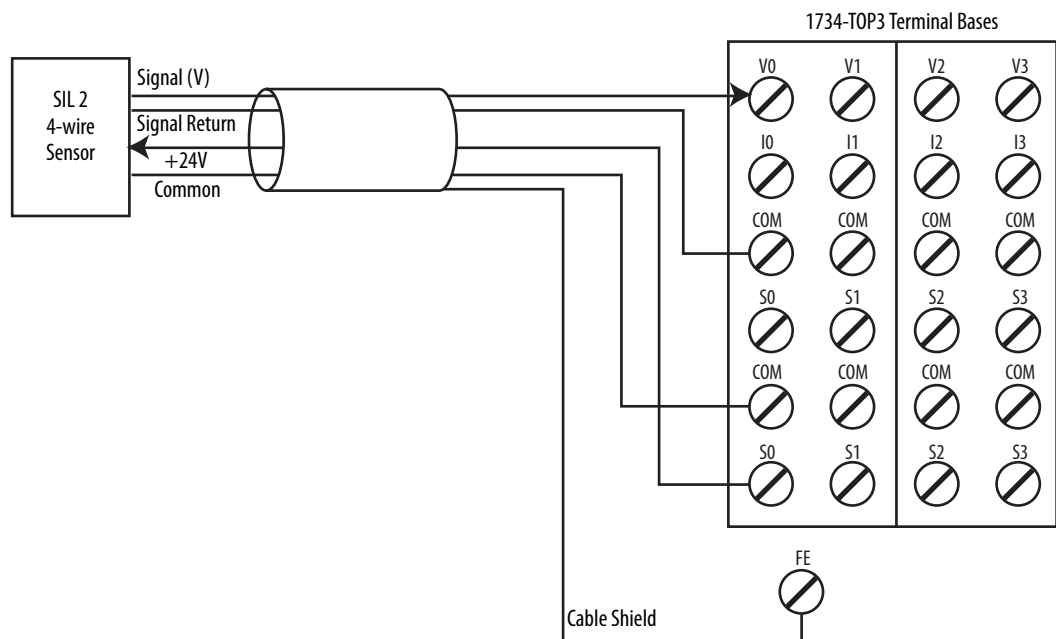


**Figure 37 - 3-wire Current Sensor (SIL 2)**



For 0...20 mA analog current-output sensors, the signal levels for operation for the application must be outside the signal level when the signal is not present, for example, when the wire is broken.

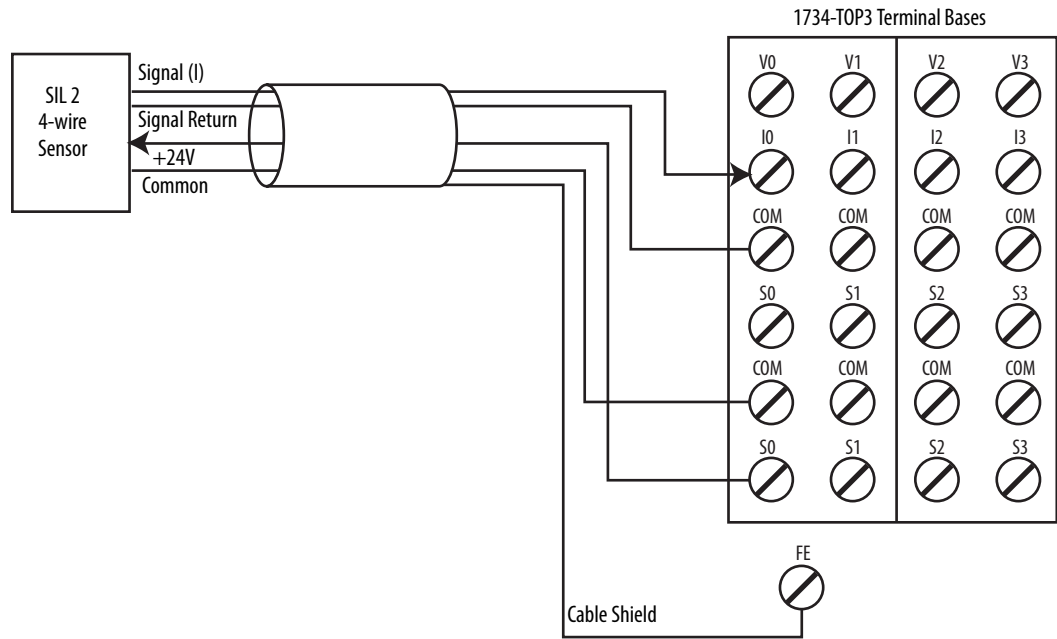
**Figure 38 - 4-wire Voltage or Tachometer Sensor (SIL 2)**



Signal Return and Common are at the same potential.  
See [Figure 47](#) and [Figure 48 on page 74](#) for tachometer wiring detail.

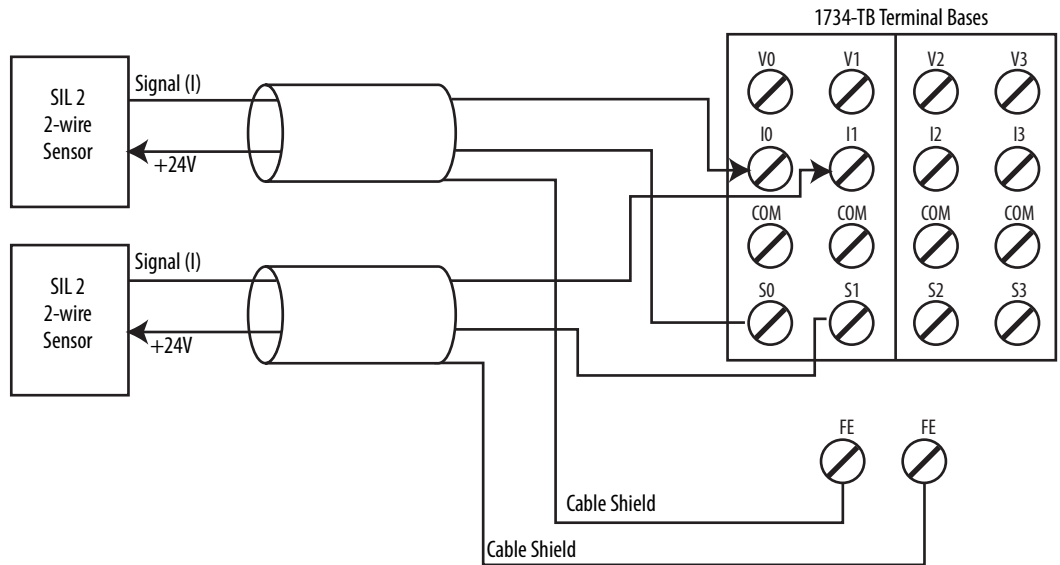
Follow the [Guidelines for Wiring Safety Analog Inputs on page 67](#).

**Figure 39 - 4-wire Current Sensor (SIL 2)**



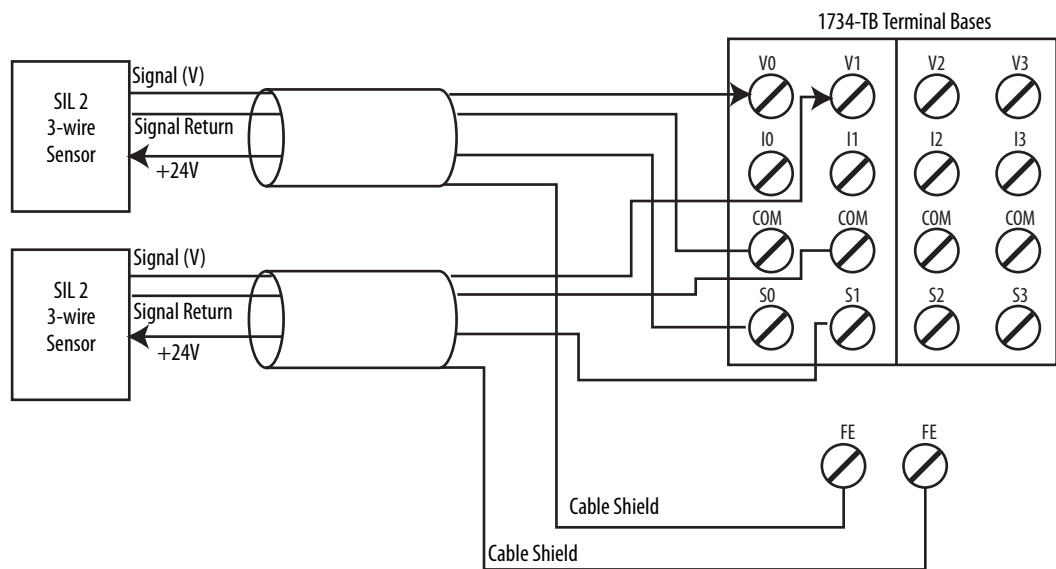
Signal Return and Common are at the same potential.

**Figure 40 - 2-wire Current (4...20 mA) Sensor (SIL 3)**



Field sensors are monitoring the same signal in a redundant configuration. You must configure a safety deadband between the two signals to achieve SIL 3.

Follow the [Guidelines for Wiring Safety Analog Inputs on page 67](#).

**Figure 41 - 3-wire Voltage or Tachometer Sensor (SIL 3)**

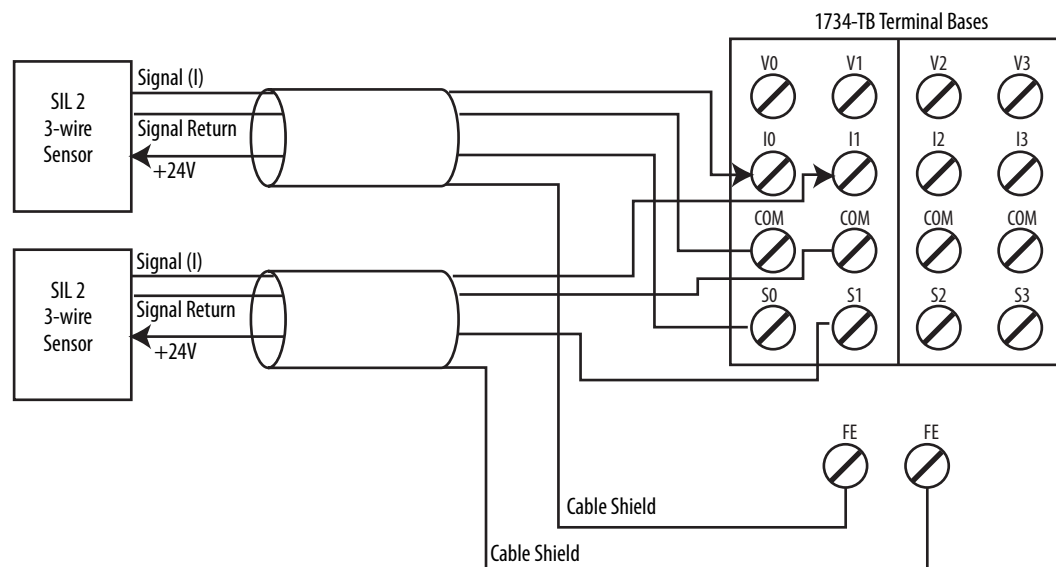
This wiring configuration can also be used for SIL 2 redundant Tachometer mode.

For analog voltage-output sensors, the signal levels for operation for the application must be outside the signal level when the signal is not present, for example, when the wire is broken.

Field sensors are monitoring the same signal in a redundant configuration.

You must configure a safety discrepancy deadband between the two signals to achieve SIL 3.

See [Figure 47](#) and [Figure 48 on page 74](#) for tachometer wiring detail.

**Figure 42 - 3-wire Current Sensor (SIL 3)**

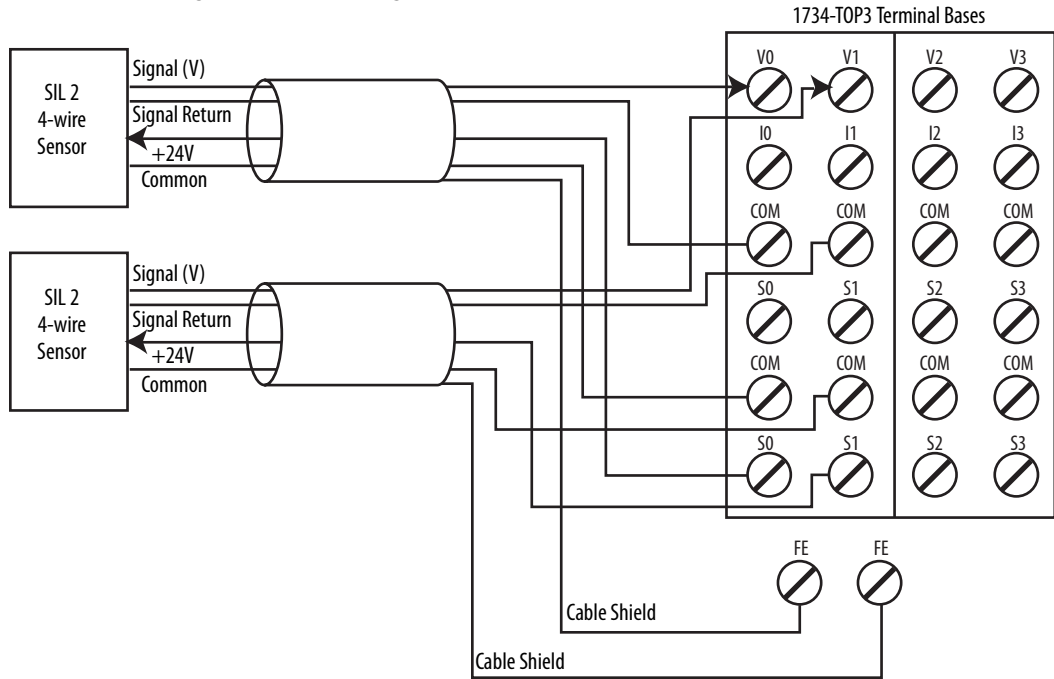
For 0...20 mA analog current-output sensors, the signal levels for operation for the application must be outside the signal level when the signal is not present, for example, when the wire is broken.

Field sensors are monitoring the same signal in a redundant configuration.

You must configure a safety discrepancy deadband between the two signals to achieve SIL 3.

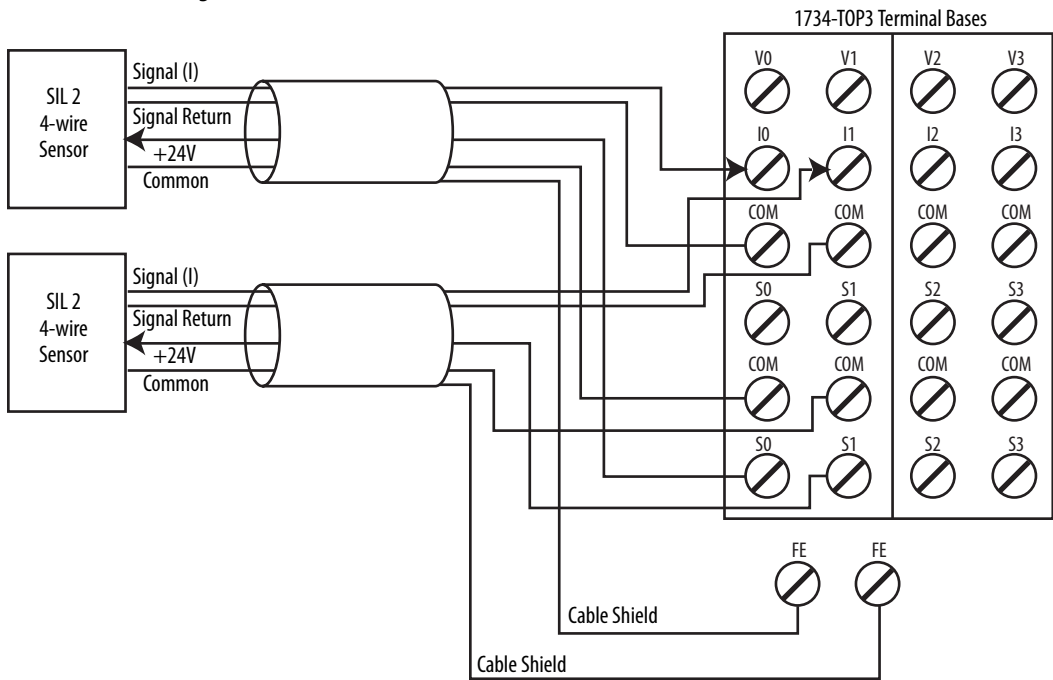
Follow the [Guidelines for Wiring Safety Analog Inputs on page 67](#).

**Figure 43 - 4-wire Voltage or Tachometer Sensor (SIL 3)**



This wiring configuration may also be used for SIL 2 redundant Tachometer mode.  
 Signal Return and Common are at the same potential.  
 Field sensors are monitoring the same signal in a redundant configuration.  
 You must configure a safety discrepancy deadband between the two signals to achieve SIL 3.  
 See [Figure 47](#) and [Figure 48 on page 74](#) for tachometer wiring detail.

**Figure 44 - 4-wire Current Sensor (SIL 3)**



Signal Return and Common are at the same potential.  
 Field sensors are monitoring the same signal in a redundant configuration.  
 You must configure a safety discrepancy deadband between the two signals to achieve SIL 3.

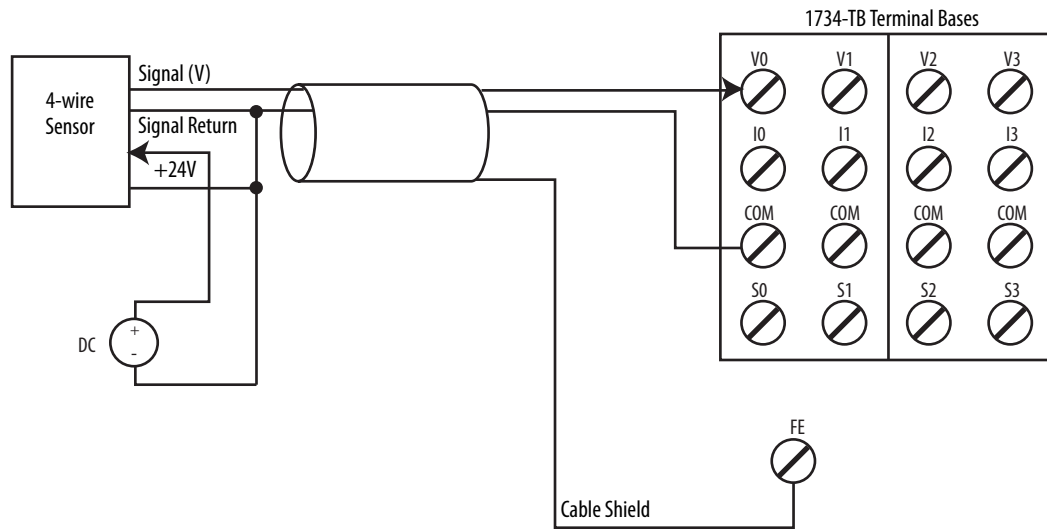
Follow the [Guidelines for Wiring Safety Analog Inputs on page 67](#).

In the following two examples, the negative terminal of the sensor power supply and that of the 1734 terminal base COMMON must be at the same potential. Use of an external power supply limits diagnostics and increases susceptibility to noise.

**IMPORTANT** You are responsible for making sure that the sensor is receiving appropriate power. Safety sensors that are not properly powered do not always deliver accurate signals to the analog input module.

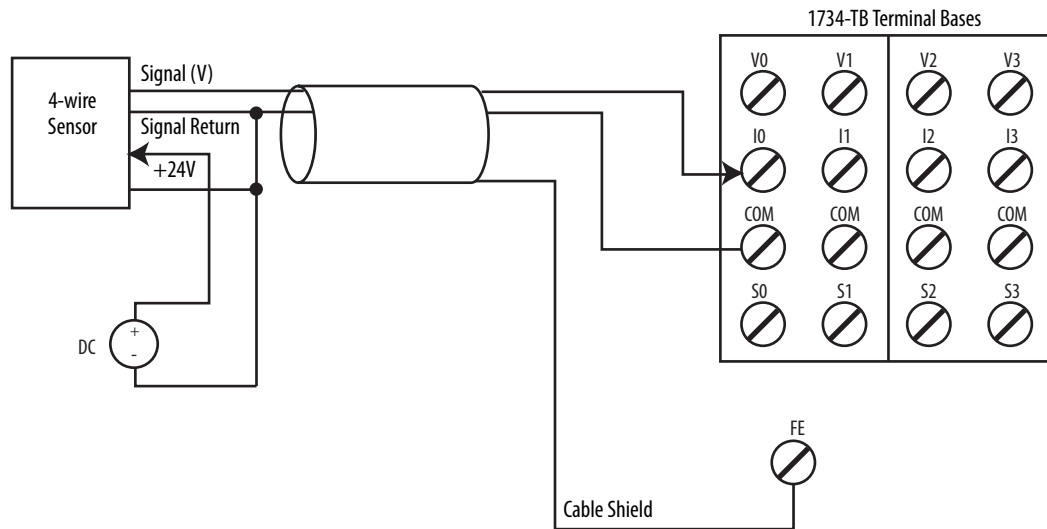
Follow the [Guidelines for Wiring Safety Analog Inputs on page 67](#).

**Figure 45 - 4-wire Voltage or Tachometer Sensor (SIL 2) with External Power Supply**



Signal Return and Common are at the same potential.  
See [Figure 47](#) and [Figure 48 on page 74](#) for tachometer wiring detail.

**Figure 46 - 4-wire Current Sensor (SIL 2) with External Power Supply**



Signal Return and Common are at the same potential.

Figure 47 - Safety Analog Input Wiring for Sinking Tachometer Sensor

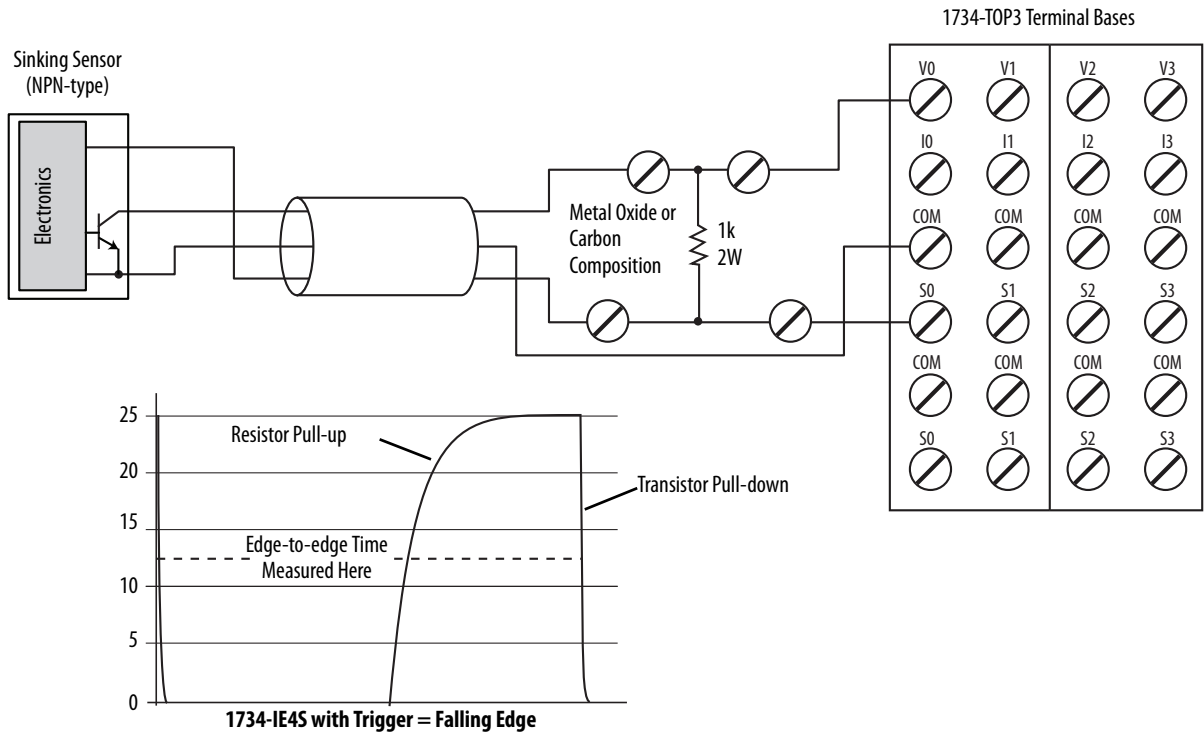
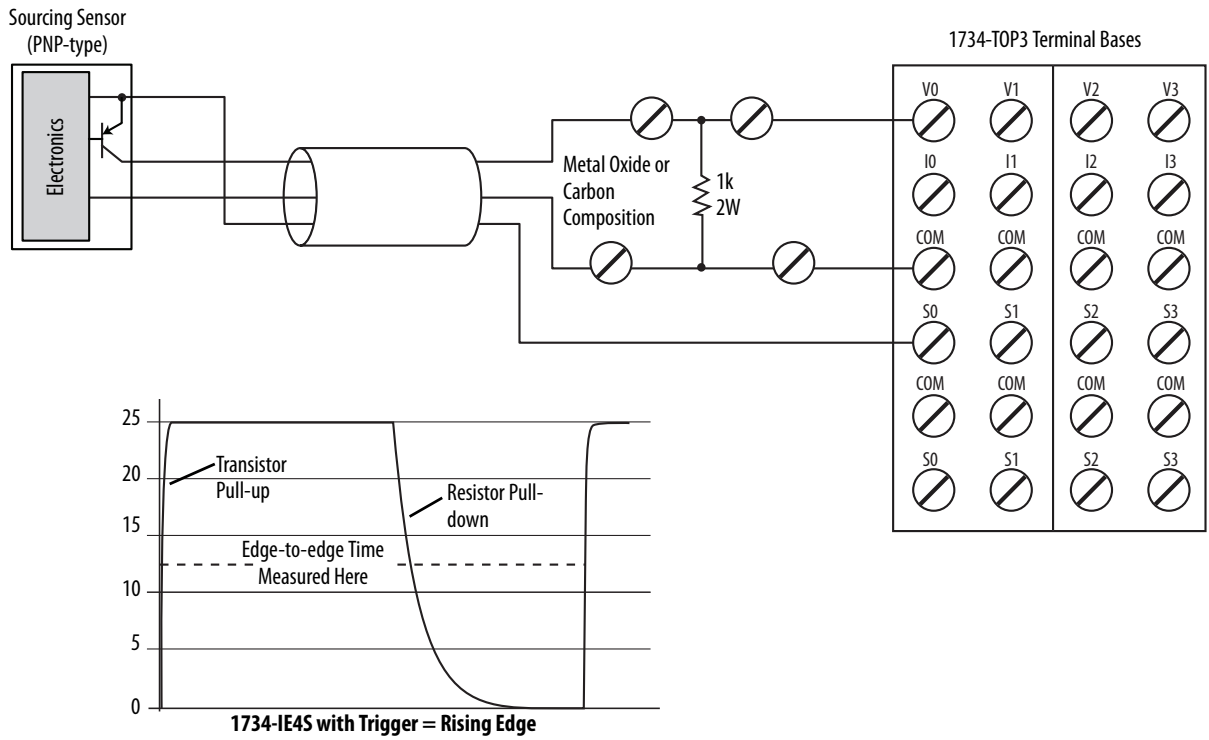


Figure 48 - Safety Analog Input Wiring for Sourcing Tachometer Sensor



Follow the [Guidelines for Wiring Safety Analog Inputs on page 67](#).

## Configure the Module in a GuardLogix Controller System

Topic	Page
Set up the Module	75
Add and Configure the Ethernet Bridge	76
Add and Configure the 1734 Ethernet Adapter	76
Add and Configure Safety Digital Input Modules	80
Add and Configure Safety Digital Output Modules	89
Add and Configure Safety Analog Input Modules	94
Values and States of Tags	103
Configure Safety Connections	105
Configuration Ownership	106
Save and Download the Module Configuration	107

### Set up the Module

When using a GuardLogix® controller on an EtherNet/IP network, configure the POINT Guard I/O™ modules by using the Logix Designer application.

---

**IMPORTANT** You **must** configure each point that is used as a safety input or output. By default, all safety input and output points are disabled.

---

**TIP** If you need an Add-on Profile, visit the My Support website at <http://support.rockwellautomation.com/ControlFLASH/LogixProfiler.asp>.

At the bottom of each dialog box, click Help for information about how to complete entries in that dialog box. At the bottom of warning dialog boxes, click Help for information about that specific error.

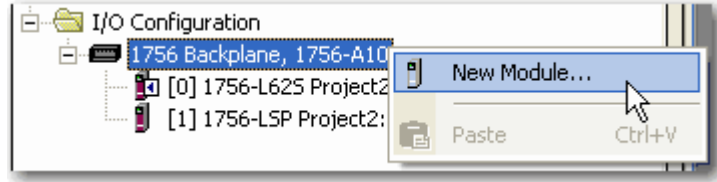
When first setting up your POINT Guard I/O modules on an EtherNet/IP network, perform the following steps.

1. [Add and Configure the Ethernet Bridge.](#)
2. [Add and Configure the 1734 Ethernet Adapter.](#)
3. [Add and Configure Safety Digital Input Modules.](#)
4. [Add and Configure Safety Digital Output Modules.](#)
5. [Add and Configure Safety Analog Input Modules.](#)

## Add and Configure the Ethernet Bridge

Follow this procedure to add and configure the Ethernet bridge. In this example, we use a 1756 GuardLogix controller.

1. From the I/O Configuration tree, right-click 1756 Backplane, 1756-Axx, and choose New Module.

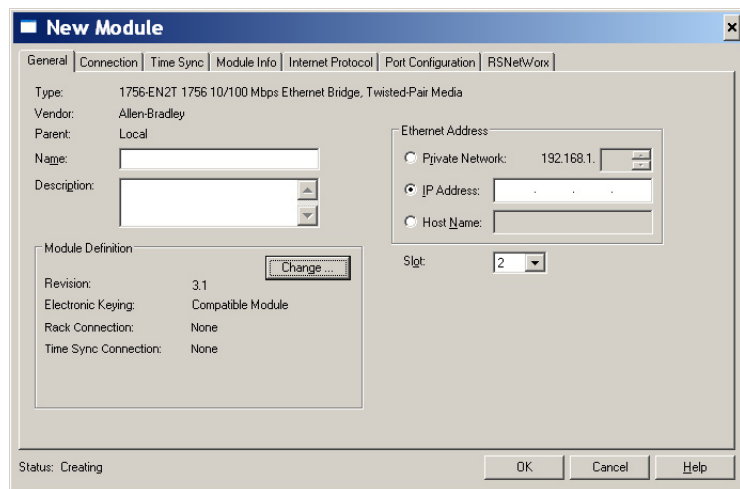


2. In the Select Modules dialog box, check Communication and Allen-Bradley®.
3. Choose an Ethernet module from the list and click Create.

In this example, we chose the 1756-EN2T bridge. These module revisions support CIP Safety.

Cat. No.	Compatible Major Revision
1756-EN2F	1 or later
1756-EN2T	1 or later
1756-ENBT	3 or later
1756-EN2TR	3 or later
1756-EN3TR	3 or later
1768-ENBT	3 or later

4. Specify the properties for the new module.



- a. In the Name field of the New Module dialog box, type the name of the Ethernet bridge.
- b. In the Description field, type an optional description.
- c. In the IP address field, type the IP address.
- d. In the Slot field, choose the slot number.

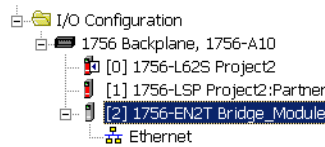


5. To edit the Module Definition, click Change.
  - a. In the Revision fields, choose the major and minor revisions.
  - b. From the Electronic Keying pull-down menu, choose the appropriate keying method.

Choose	Description
Compatible Module	Allows a module to determine whether it can emulate the module that is defined in the configuration that is sent from the controller.
Disable Keying	None of the parameters in the physical module and module that is configured in the software must match. <b>Do not choose Disable Keying.</b>
Exact Match	All parameters must match or the inserted module rejects a connection to the controller.

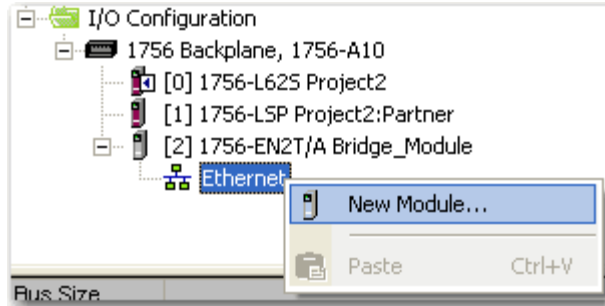
6. Click OK.

The I/O Configuration tree displays the Ethernet connection.



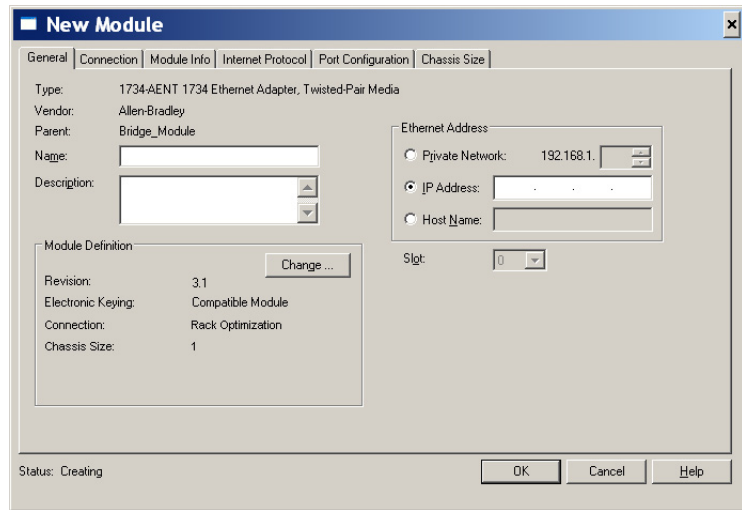
## Add and Configure the 1734 Ethernet Adapter

1. Right-click the Ethernet connection and choose New Module.

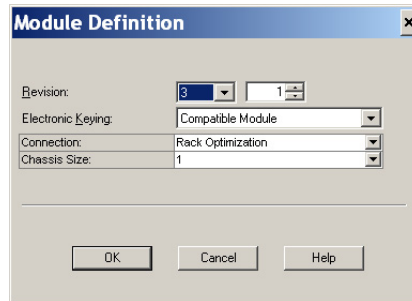


2. On the Select Module dialog box, check Communication and Allen-Bradley.
3. Choose an Ethernet adapter from the list and click Create.

4. Specify the general properties of the Ethernet adapter.



- a. In the Name field of the New Module dialog box, type the name of the 1734 Ethernet adapter.
  - b. In the Description field, type a description, if desired.
  - c. In the IP address field, type the IP address.
5. To edit the Ethernet adapter Definition, click Change.



- a. In the Revision fields, choose the major and minor revisions.

---

**IMPORTANT** 1734-AENT adapter firmware must be major revision 3 or later to support POINT Guard I/O modules.

---

- b. From the Electronic Keying pull-down menu, choose the appropriate keying method.

Choose	Description
Exact Match	Module and type series must exactly match or the module is rejected by the controller.
Compatible Module	Controller checks module type and revision for compatibility. Compatible modules that match or are newer are accepted.
Disable Keying	Controller checks module type, but accepts any version. <b>Do not choose Disable Keying.</b>

- c. From the Connection pull-down menu, choose the appropriate connection for the 1734 Ethernet adapter.

Choose	Description
Listen Only	Read or verify standard digital I/O data only, but does not control the modules. (When you have multiple controllers, one controller is used to control and the other controllers are used to monitor.)
None	The adapter makes a direct connection to each of the module's listed under the 1734-AENT adapter in the I/O Configuration tree.
Rack Optimization	Standard digital I/O data is collected into one rack image. <b>POINT specialty, analog, or safety (POINT Guard I/O) modules do not use rack optimization.</b>

**TIP** If there are no standard digital I/O modules in your POINT I/O™ system, choose None.

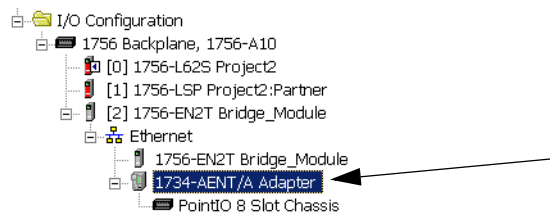
- d. From the Chassis Size pull-down menu, choose the number of POINT I/O modules that are attached to the 1734 Ethernet adapter plus 1 for the 1734 Ethernet adapter.

**IMPORTANT** Do not count terminal bases. Enter only the number of physical modules that are installed, plus 1 for the adapter. This number must match exactly. You cannot enter a higher number anticipating future expansion.

Each POINT Guard module that you configure can consume up to 2 connections of the 20 connection limit within the 1734-AENT or 1734-AENTR modules. Be sure that you are aware of and design your POINT system with these limits in mind.

6. Click OK to return to the Module Properties dialog box.
7. Click OK again to apply your changes.

The I/O Configuration tree displays the 1734 Ethernet adapter.



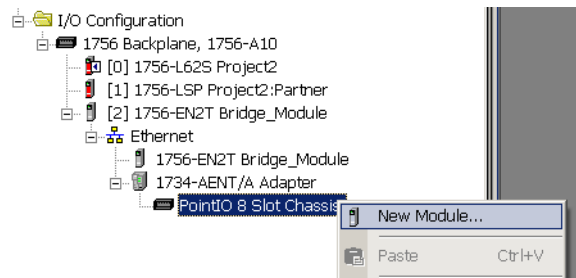
## Add and Configure Safety Digital Input Modules

To include a safety digital input module in the project, you add the module under the I/O chassis in the I/O Configuration tree. Then configure the general properties of the module, configure the digital inputs, and configure test outputs as described in the following sections.

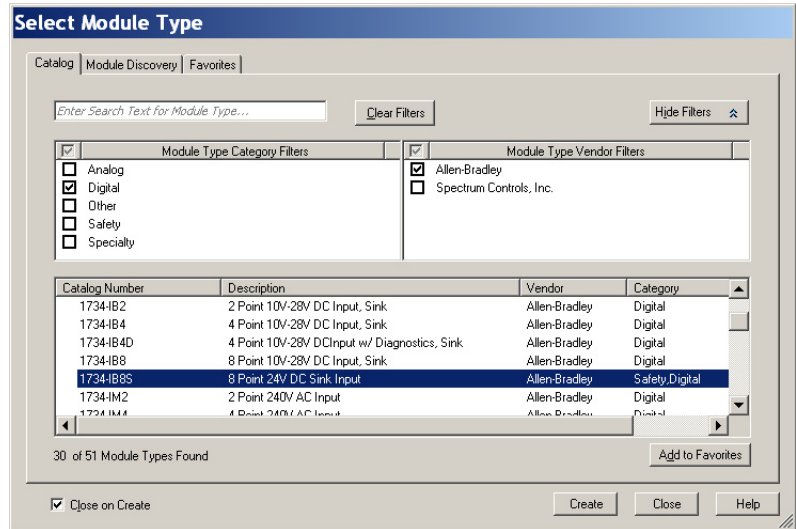
### Add the Safety Digital Input Module

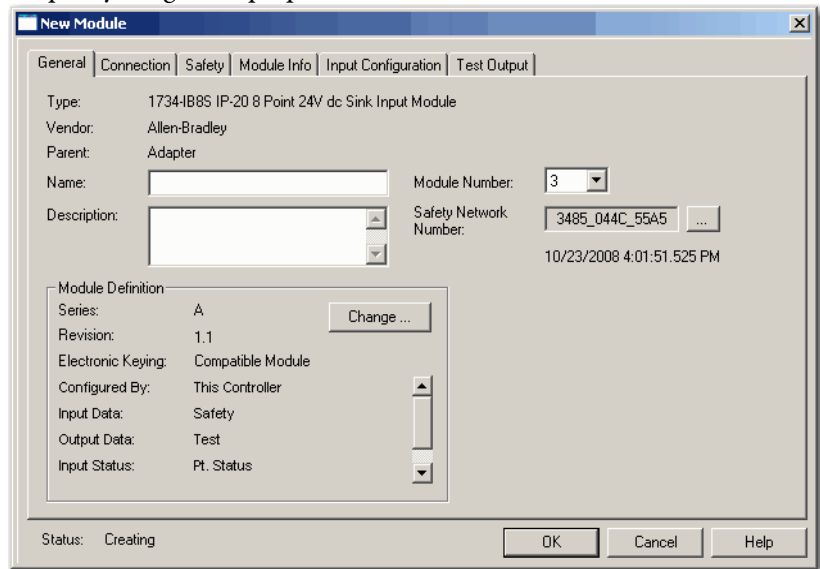
To add the POINT Guard I/O safety digital input module, follow these steps.

1. Right-click the POINT I/O Chassis and choose New Module.



2. From the Select Module dialog box, check Digital and Allen-Bradley.
3. Select an input module and click Create.



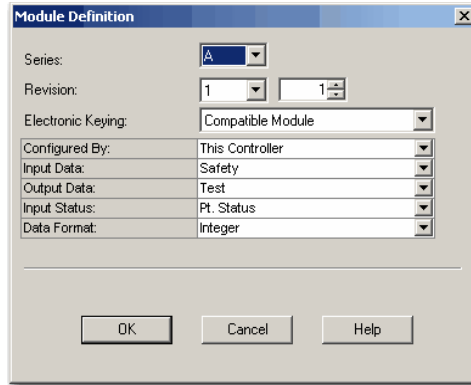
**4. Specify the general properties of the module.**

- a. In the Name field of the New Module dialog box, type a unique name for the input module.
- b. From the Module Number pull-down menu, choose a unique module number that corresponds to the position of the module in the chassis.
- c. In the Description field, type a description, if desired.
- d. In the Safety Network Number field, use the default setting.

For a detailed explanation of the safety network number (SNN), see the GuardLogix Controller Systems Safety Reference Manuals that are listed in the Additional Resources on [page 10](#). However, in most cases, you use the default that is provided by the Logix Designer application.

The purpose of the safety network number (SNN) is to make sure that every module in a system can be uniquely identified. We suggest that all safety modules on a network have the same SNN, to make documentation easier. During configuration, the Logix Designer application defaults an SNN of a safety device to match the SNN of the lowest safety node on each network.

5. To edit the Module Definition, click Change.



- a. In the Series field, choose the input series letter of the module.
- b. In the Revision fields, choose the input revision number of the module.
- c. From the Electronic Keying pull-down menu, choose the appropriate keying method for the input module.

Choose	Description
Exact Match	All parameters must match or the inserted module rejects a connection to the controller.
Compatible Module	Allows an I/O module to determine whether it can emulate the module that is defined in the configuration that is sent from the controller.

- d. From the Configured By pull-down menu, choose the appropriate method by which this module is configured.

Choose	Description
This Controller	This selection directs the controller to configure the module.
External Means	This selection directs the controller to establish a safety input connection only, and the controller doesn't configure the module or control the Test Outputs.

- e. From the Input Data pull-down menu, choose Safety or None.

Choose	Description
Safety	These tags are created for the target module: <ul style="list-style-type: none"> <li>• RunMode for module mode</li> <li>• ConnectionFaulted for communication status</li> <li>• Safety Data for safety inputs from the module</li> </ul>

Module Path	Value	Format	Address	Type
AENT_Adapter:1:I	{...}	{...}	AB:1734_IB8S_Safety2:I:0	Safety
AENT_Adapter:1:I.RunMode	0	Decimal	BOOL	Safety
AENT_Adapter:1:I.ConnectionFault...	0	Decimal	BOOL	Safety
AENT_Adapter:1:I.Pt00Data	0	Decimal	BOOL	Safety
AENT_Adapter:1:I.Pt01Data	0	Decimal	BOOL	Safety
AENT_Adapter:1:I.Pt02Data	0	Decimal	BOOL	Safety
AENT_Adapter:1:I.Pt03Data	0	Decimal	BOOL	Safety
AENT_Adapter:1:I.Pt04Data	0	Decimal	BOOL	Safety
AENT_Adapter:1:I.Pt05Data	0	Decimal	BOOL	Safety
AENT_Adapter:1:I.Pt06Data	0	Decimal	BOOL	Safety
AENT_Adapter:1:I.Pt07Data	0	Decimal	BOOL	Safety

- f. From the Output Data pull-down menu, choose from the following options.

Choose	Description
None	Results in an input only connection to the module. Inputs and status are read, but no outputs are written. You can still use the test outputs as pulse test outputs or a power supply. If you are not controlling the test outputs of the module via application logic, this is the recommended setting.
Test <sup>(1)</sup>	Creates these tags to enable application logic control of the test outputs on the module. This selection allows the test outputs to be used as standard outputs and muting outputs.

- AENT_Adapter:1:0	{...}	{...}		AB:1734_IB8S:0:0	Safety
-AENT_Adapter:1:0.Test00Data	0		Decimal	BOOL	Safety
-AENT_Adapter:1:0.Test01Data	0		Decimal	BOOL	Safety
-AENT_Adapter:1:0.Test02Data	0		Decimal	BOOL	Safety
-AENT_Adapter:1:0.Test03Data	0		Decimal	BOOL	Safety

- (1) To have this choice from the pull-down menu, you must choose 'This Controller' from the Configured By pull-down menu.

---

**IMPORTANT** When test outputs are configured as standard outputs, they must not be used for safety purposes.

---

- g. From the Input Status pull-down menu, choose from the following options.

Choose	Description
None	There are no status tags.
Pt. Status	There is one status tag for each input point.

AENT_Adapter:1:I.Pt00Status	0	Decimal	BOOL	Safety
AENT_Adapter:1:I.Pt01Status	0	Decimal	BOOL	Safety
AENT_Adapter:1:I.Pt02Status	0	Decimal	BOOL	Safety
AENT_Adapter:1:I.Pt03Status	0	Decimal	BOOL	Safety
AENT_Adapter:1:I.Pt04Status	0	Decimal	BOOL	Safety
AENT_Adapter:1:I.Pt05Status	0	Decimal	BOOL	Safety
AENT_Adapter:1:I.Pt06Status	0	Decimal	BOOL	Safety
AENT_Adapter:1:I.Pt07Status	0	Decimal	BOOL	Safety

- Combined Status - Muting
- One BOOL tag represents an AND of the status bits for all input points. For example, if any input channel has a fault, this bit goes LO.<sup>(1)</sup>
  - One BOOL tag represents the Input Power Status (error bit) from the input assembly.
  - A muting status tag for test output T1 and T3.

AENT_Adapter:1:I.Muting01Status	0	Decimal	BOOL	Safety
AENT_Adapter:1:I.Muting03Status	0	Decimal	BOOL	Safety
AENT_Adapter:1:I.InputPowerStatus	0	Decimal	BOOL	Safety
AENT_Adapter:1:I.CombinedInputStatus	0	Decimal	BOOL	Safety

- Pt. Status - Muting
- There is a muting status tag for test output T1 and T3 with point status for each input point.

Adapter:1:I.Pt00Status	0	Decimal	BOOL	Safety
Adapter:1:I.Pt01Status	0	Decimal	BOOL	Safety
Adapter:1:I.Pt02Status	0	Decimal	BOOL	Safety
Adapter:1:I.Pt03Status	0	Decimal	BOOL	Safety
Adapter:1:I.Pt04Status	0	Decimal	BOOL	Safety
Adapter:1:I.Pt05Status	0	Decimal	BOOL	Safety
Adapter:1:I.Pt06Status	0	Decimal	BOOL	Safety
Adapter:1:I.Pt07Status	0	Decimal	BOOL	Safety
Adapter:1:I.Muting01Status	0	Decimal	BOOL	Safety
Adapter:1:I.Muting03Status	0	Decimal	BOOL	Safety
Adapter:1:I.InputPowerStatus	0	Decimal	BOOL	Safety

- Pt. Status-Muting-Test Output
- Status tags for each of the input points.
  - Muting status tag for test output T1 and T3.
  - Status tags for each of the test outputs.

Adapter:1:I.Pt00Status	0	Decimal	BOOL	Safety
Adapter:1:I.Pt01Status	0	Decimal	BOOL	Safety
Adapter:1:I.Pt02Status	0	Decimal	BOOL	Safety
Adapter:1:I.Pt03Status	0	Decimal	BOOL	Safety
Adapter:1:I.Pt04Status	0	Decimal	BOOL	Safety
Adapter:1:I.Pt05Status	0	Decimal	BOOL	Safety
Adapter:1:I.Pt06Status	0	Decimal	BOOL	Safety
Adapter:1:I.Pt07Status	0	Decimal	BOOL	Safety
Adapter:1:I.Pt00TestOutputStatus	0	Decimal	BOOL	Safety
Adapter:1:I.Pt01TestOutputStatus	0	Decimal	BOOL	Safety
Adapter:1:I.Pt02TestOutputStatus	0	Decimal	BOOL	Safety
Adapter:1:I.Pt03TestOutputStatus	0	Decimal	BOOL	Safety
Adapter:1:I.Muting01Status	0	Decimal	BOOL	Safety
Adapter:1:I.Muting03Status	0	Decimal	BOOL	Safety
Adapter:1:I.InputPowerStatus	0	Decimal	BOOL	Safety

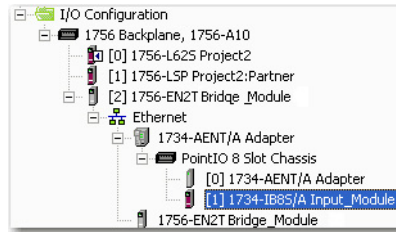
(1) When using combined status, use explicit messaging to read individual point status for diagnostic purposes.

- h. From the Data Format pull-down menu, use the default 'Integer'.



6. Click OK to return to the Module Properties dialog box.
7. Click OK again to apply your changes.

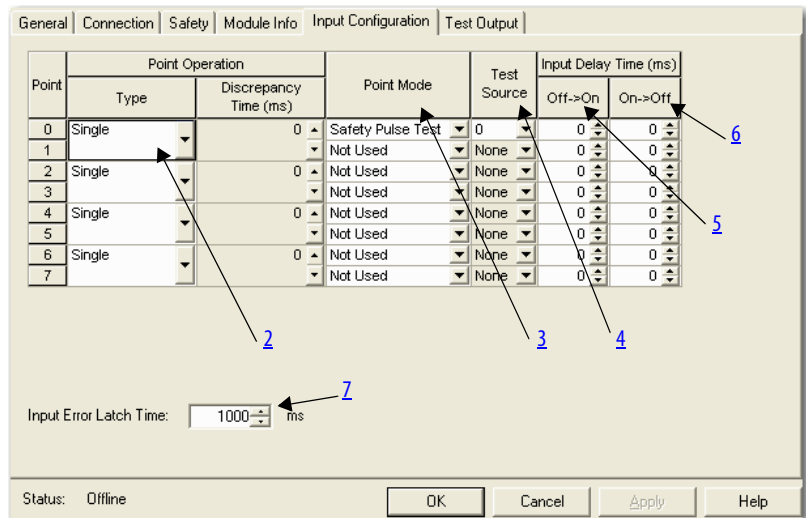
The I/O Configuration tree displays the module.



### Configure the Safety Digital Inputs

To configure the safety digital inputs, follow this procedure.

1. From the Module Properties dialog box, click the Input Configuration tab.



2. Assign the Point Operation Type.

Choose	Description
Single	Inputs are treated as single channels. Dual-channel safety inputs can be configured as two individual single channels. This configuration does not affect pulse tests because it is handled on an individual channel basis. <b>IMPORTANT:</b> Use single-channel mode when you intend to use the GuardLogix safety application instructions.
Equivalent	Inputs are treated as a dual-channel pair. The channels must match within the discrepancy time or an error is generated.
Complementary	Inputs are treated as a dual-channel pair. They must be in opposite states within the discrepancy time or an error is generated.

When you choose Equivalent or Complementary, you must also assign a Discrepancy Time.

A discrepancy time setting of 0 ms means that the channels in a dual configuration can be discrepant for an infinite amount of time without a fault being declared.

For a discrepancy time setting of 0 ms, the evaluated status of the inputs still goes to the safe state due to a ‘cycle inputs’ required condition. However, with a 0 ms discrepancy time setting, a fault is not declared.

A ‘cycle inputs’ required condition occurs when one input terminal goes from its normal Active->Inactive->Active state while the other input terminal remains in its normal Active state. Even though no fault is declared, the inputs must be cycled through the safe state before the evaluated status of the inputs can return to the Active state. When in a ‘cycle inputs’ required condition, the logical state does not necessarily match the voltage at the terminals.

---

**IMPORTANT** Configuring discrepancy time on safety I/O modules masks input discrepancies that the controller safety instructions detect. The controller reads status to obtain this fault information.

---

**3. Assign the Point Mode.**

Choose	Description
Not Used	The input is disabled. If 24V is applied to the input terminal, it remains logic 0.
Safety Pulse Test	Pulse tests are performed on this input circuit. A test source on the POINT Guard I/O module <b>must</b> be used as the 24V source for this circuit. The test source is configured by using the test source pull-down menu. The pulse test detects shorts to 24V and channel-to-channel shorts to other inputs.
Safety	A safety input is connected but there is no requirement for the POINT Guard I/O module to perform a pulse test on this circuit. An example is a safety device that performs its own pulse tests on the input wires, such as a light curtain.
Standard	A standard device, such as a reset switch, is connected. This point cannot be used in dual-channel operation.

**4. Assign a Test Source for each safety input on the module you want to pulse test.**

Choose	Description
None	If pulse tests are performed on an input point, then the test source that is sourcing the 24V for the input circuit must be selected. If the incorrect test source is entered, the result is pulse test failures on that input circuit.
Test Output 0	
Test Output 1 <sup>(1)</sup>	
Test Output 2	
Test Output 3 <sup>(1)</sup>	

(1) Test Output 1 and 3 incorporate optional muting functionality.

**5. Assign the Input Delay Time, Off -> On (0...126 ms, in increments of 6 ms).**

Filter time is for OFF to ON transition. Input must be high after input delay has elapsed before it is set logic 1. This delay time is configured per channel with each channel that is tuned to match the characteristics of the field device, for maximum performance.

**6. Assign the Input Delay Time, Off -> On (0...126 ms, in increments of 6 ms).**

Filter time is ON to OFF transition. Input must be low after input delay has elapsed before it is set logic 0. This delay time is configured per channel with each channel that is tuned to match the characteristics of the field device, for maximum performance.

- From the Input Error Latch Time field, enter the time that the module holds an error to make sure that the controller can detect it (0...65,530 ms, in increments of 10 ms - default 1000 ms).

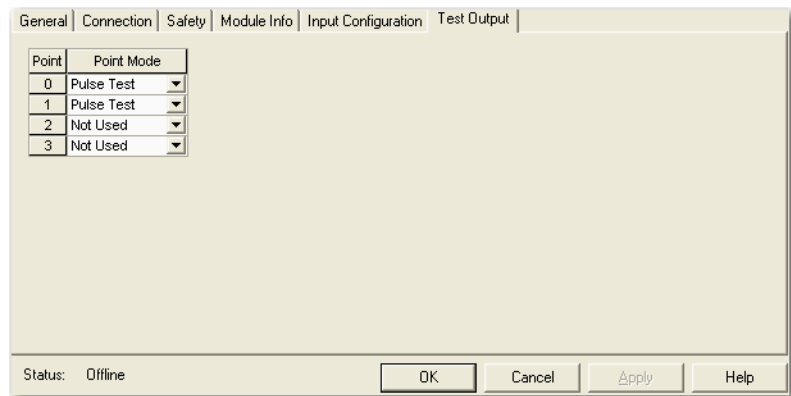
This setting provides more accurate diagnostics. The purpose for latching input errors is to make sure that intermittent faults that can exist only for a few milliseconds are latched long enough for the controller to read. The amount of time to latch the errors are based on the RPI, the safety task watchdog, and other application-specific variables.

- Click Apply.

## Configure the Test Outputs

To complete the test output configuration, follow this procedure.

- From the Module Properties dialog box, click the Test Output tab.



- Assign the Point Mode.

Choose	Description
Not Used	The test output is disabled (default for T2 and T3).
Standard	The test output point is controlled programmatically by the GuardLogix controller.
Pulse Test	The test output is being used as a pulse test source (default for T0 and T1).
Power Supply	A constant 24V is placed on the output terminal. It can be used to provide power to a field device.
Muting Lamp Output (terminals T1 and T3 only)	An indicator lamp is connected to the output. When this lamp is energized, a burned-out bulb, broken wire, or short to GND error condition can be detected. Typically, the lamp is an indicator that is used in light curtain applications.

There is also a Test Output Fault Action parameter that can only be read or written to via explicit messaging. If communication to the module times out, you can set the test outputs to Clear OFF (default) or Hold Last State. For more information, see [Appendix B](#).

- Click Apply.

## Add and Configure Safety Digital Output Modules

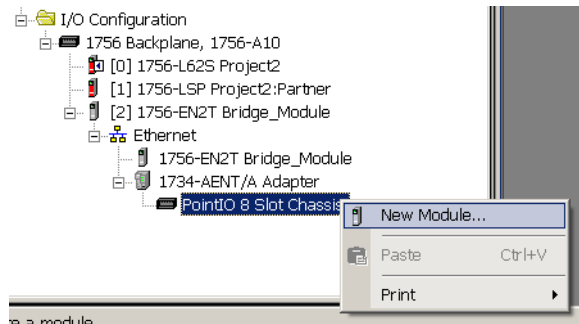
To include a POINT Guard safety digital-output module in the project, you add the module to the POINT I/O™ Chassis. Configure the general properties of the module, and configure the digital outputs as described in the following sections.

### Add the Safety Digital Output Module

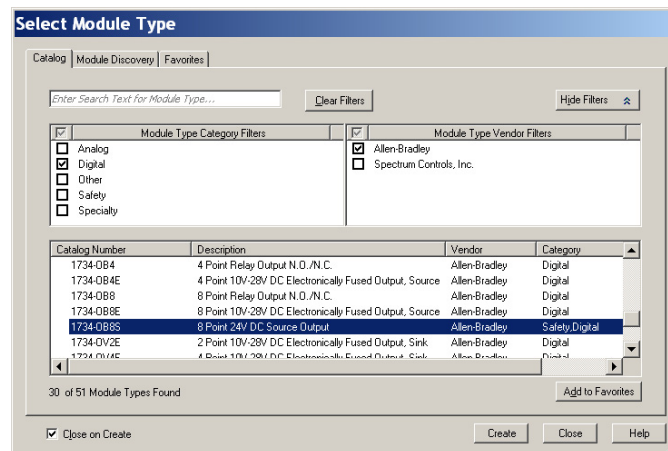
To add the POINT Guard I/O safety digital output module, follow these steps.

To add and configure POINT Guard I/O safety modules, follow these steps.

1. Right-click the POINT I/O Chassis and choose New Module.

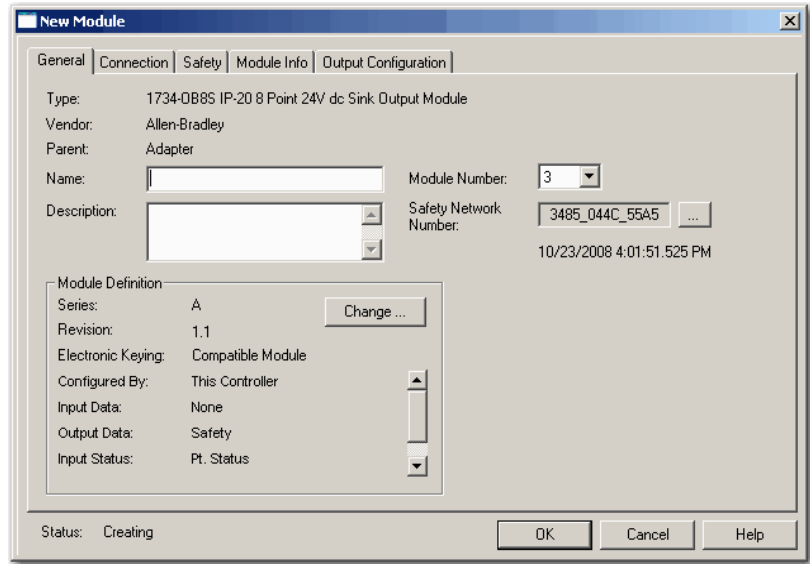


2. On the Select Module dialog box, select a safety output module and click OK.



The 1734-OB8S module is shown in the examples.

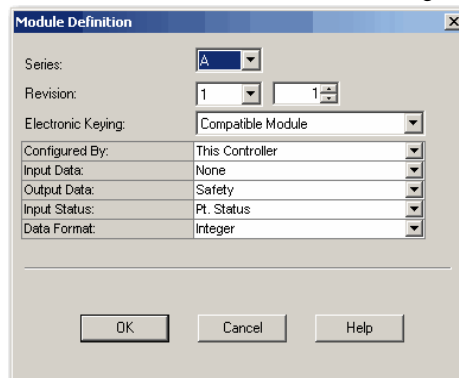
3. Specify the general properties of the module.



- a. In the Name field of the New Module dialog box, type a unique name for the output module.
- b. From the Module Node pull-down menu, choose a unique module node number that corresponds to the position of the module in the chassis.
- c. In the Description field, type a description, if desired.
- d. In the Safety Network Number field, use the default setting.

For a detailed explanation of the safety network number (SNN), see the GuardLogix Controller Systems Safety Reference Manuals that are listed in the Additional Resources on [page 10](#). In most cases, you use the default that is provided by the Logix Designer application.

4. Under Module Definition, click Change to edit the settings of the module.



- a. In the Series field, choose the series letter of the output module.
- b. In the Revision fields, choose the revisions numbers of the output module.

- c. From the Electronic Keying pull-down menu, choose the appropriate keying method from the following options.

Choose	Description
Exact Match	All parameters must match or the inserted module rejects a connection to the controller.
Compatible Module	Lets an I/O module determine whether it can emulate the module that is defined in the configuration that is sent from the controller.

- d. From the Configured By pull-down menu, choose the method by which this module is configured.

Choose	Description
This Controller	This selection directs the controller to configure and control the safety outputs. The Output Data selection is set to Safety.
External Means	This selection directs the controller to establish a safety input connection only, and the controller does not configure the module or be able to control the safety outputs. The Output Data selection is set to None.

- e. From the Input Data pull-down menu, choose None.  
None is the only valid selection, as this module is an output-only safety module.

- f. From the Output Data pull-down menu, choose from the following:

Choose	Description
Safety	Automatically selected when Configured By = This controller. Results in an output connection. When you select Safety, an output tag is created for each output point and enables these outputs for use in the Safety Task.

POINT_Guard:1:0	{...}	{...}	AB:1734_0B8S:0:0	Safety
POINT_Guard:1:0.Pi00Data	0	Decimal	BOOL	Safety
POINT_Guard:1:0.Pi01Data	0	Decimal	BOOL	Safety
POINT_Guard:1:0.Pi02Data	0	Decimal	BOOL	Safety
POINT_Guard:1:0.Pi03Data	0	Decimal	BOOL	Safety
POINT_Guard:1:0.Pi04Data	0	Decimal	BOOL	Safety
POINT_Guard:1:0.Pi05Data	0	Decimal	BOOL	Safety
POINT_Guard:1:0.Pi06Data	0	Decimal	BOOL	Safety
POINT_Guard:1:0.Pi07Data	0	Decimal	BOOL	Safety

None	Automatically selected when Configured By = External. When you select None, it results in an input only connection to the module. Status is read, but no outputs are written.
------	---

g. From the Input Status pull-down menu, choose from the following.

Choose	Description
None	There are no status tags, only data for the outputs.
Pt. Status	There is one status tag for each output point.

-AENT_Adapter:1:I.Pt00OutputStatus	0	Decimal	BOOL	Safety
-AENT_Adapter:1:I.Pt01OutputStatus	0	Decimal	BOOL	Safety
-AENT_Adapter:1:I.Pt02OutputStatus	0	Decimal	BOOL	Safety
-AENT_Adapter:1:I.Pt03OutputStatus	0	Decimal	BOOL	Safety
-AENT_Adapter:1:I.Pt04OutputStatus	0	Decimal	BOOL	Safety
-AENT_Adapter:1:I.Pt05OutputStatus	0	Decimal	BOOL	Safety
-AENT_Adapter:1:I.Pt06OutputStatus	0	Decimal	BOOL	Safety
-AENT_Adapter:1:I.Pt07OutputStatus	0	Decimal	BOOL	Safety

Pt. Status - Readback

- There is one status tag for each output point.
- There is one data tag for the output readback.

-AENT_Adapter:1:I.Pt00OutputStatus	0	Decimal	BOOL	Safety
-AENT_Adapter:1:I.Pt01OutputStatus	0	Decimal	BOOL	Safety
-AENT_Adapter:1:I.Pt02OutputStatus	0	Decimal	BOOL	Safety
-AENT_Adapter:1:I.Pt03OutputStatus	0	Decimal	BOOL	Safety
-AENT_Adapter:1:I.Pt04OutputStatus	0	Decimal	BOOL	Safety
-AENT_Adapter:1:I.Pt05OutputStatus	0	Decimal	BOOL	Safety
-AENT_Adapter:1:I.Pt06OutputStatus	0	Decimal	BOOL	Safety
-AENT_Adapter:1:I.Pt07OutputStatus	0	Decimal	BOOL	Safety
-AENT_Adapter:1:I.Pt00Readback	0	Decimal	BOOL	Safety
-AENT_Adapter:1:I.Pt01Readback	0	Decimal	BOOL	Safety
-AENT_Adapter:1:I.Pt02Readback	0	Decimal	BOOL	Safety
-AENT_Adapter:1:I.Pt03Readback	0	Decimal	BOOL	Safety
-AENT_Adapter:1:I.Pt04Readback	0	Decimal	BOOL	Safety
-AENT_Adapter:1:I.Pt05Readback	0	Decimal	BOOL	Safety
-AENT_Adapter:1:I.Pt06Readback	0	Decimal	BOOL	Safety
-AENT_Adapter:1:I.Pt07Readback	0	Decimal	BOOL	Safety

Combined Status - Readback - Power

- There is one data tag for output readback on each output point.
- One BOOL tag represents the Output Power Status (error bit) from the input assembly.
- One BOOL tag represents an AND of the status bits for all output points. (Combined Output Status). For example, if any output channel has a fault, this bit goes LO.<sup>(1)</sup>

-AENT_Adapter:1:I.Pt00Readback	0	Decimal	BOOL	Safety
-AENT_Adapter:1:I.Pt01Readback	0	Decimal	BOOL	Safety
-AENT_Adapter:1:I.Pt02Readback	0	Decimal	BOOL	Safety
-AENT_Adapter:1:I.Pt03Readback	0	Decimal	BOOL	Safety
-AENT_Adapter:1:I.Pt04Readback	0	Decimal	BOOL	Safety
-AENT_Adapter:1:I.Pt05Readback	0	Decimal	BOOL	Safety
-AENT_Adapter:1:I.Pt06Readback	0	Decimal	BOOL	Safety
-AENT_Adapter:1:I.Pt07Readback	0	Decimal	BOOL	Safety
-AENT_Adapter:1:I.OutputPowerStatus	0	Decimal	BOOL	Safety
-AENT_Adapter:1:I.CombinedOutputStatus	0	Decimal	BOOL	Safety

(1) When using combined status, use explicit messaging to read individual point status for diagnostic purposes.

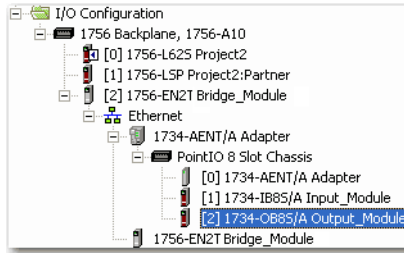
h. From the Data Format pull-down menu, use the default 'Integer'.

5. Click OK to return to the Module Properties dialog box.



- Click OK again to apply your changes.

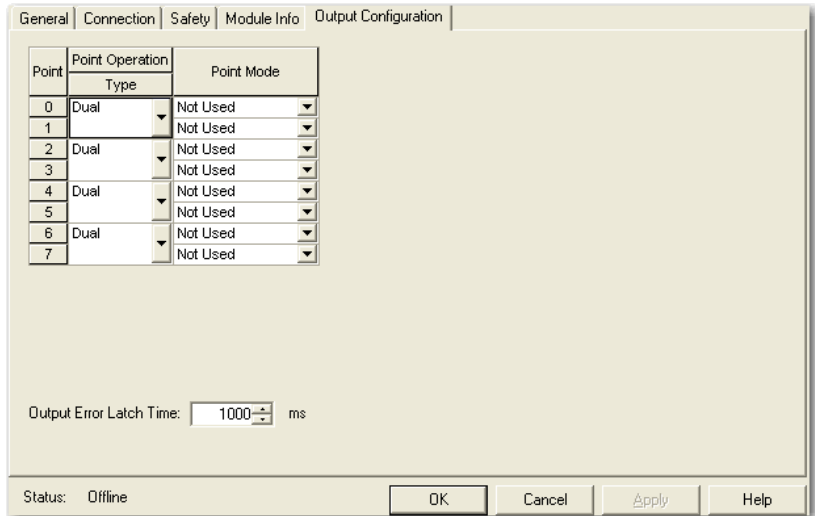
The I/O Configuration tree displays the output module.



## Configure the Safety Digital Outputs

To configure the safety digital outputs, follow this procedure.

- From the Module Properties dialog box, click the Output Configuration tab.



- Assign the Point Operation Type.

Choose	Description
Single	The output is treated as one channel.
Dual (default)	The POINT Guard I/O module treats the outputs as a pair. It always sets them HI or LO as a matched pair. Safety logic must set both of these outputs ON or OFF simultaneously or the module declares a channel fault.

- Assign the Point Mode.

Choose	Description
Not Used	The output is disabled.
Safety	The output point is enabled and does not perform a pulse test on the output.
Safety Pulse Test	The output point is enabled and performs a pulse test on the output. When the output is energized, the output pulses low briefly. The pulse test detects whether the output is functioning properly.

- In the Output Error Latch Time field, enter the time that the module holds an error to make sure that the controller can detect it (0...65,530 ms, in increments of 10 ms - default 1000 ms).

This action provides more accurate diagnostics. The purpose for latching output errors is to make sure that intermittent faults that can exist only for a few milliseconds are latched long enough for the controller to read. The amount of time to latch the errors is based on the RPI, the safety task watchdog, and other application-specific variables.

- Click Apply.

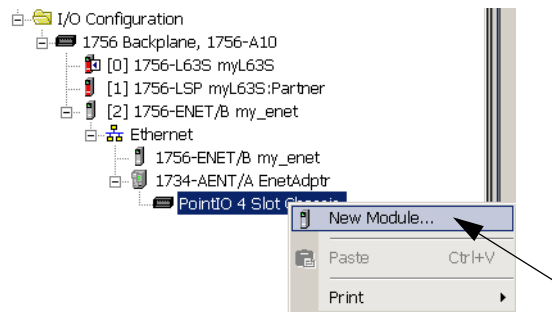
## Add and Configure Safety Analog Input Modules

To include a POINT Guard safety analog input module in the project, you add the module to the POINT I/O™ Chassis, configure the general properties of the module, and configure the analog inputs as described in the following sections.

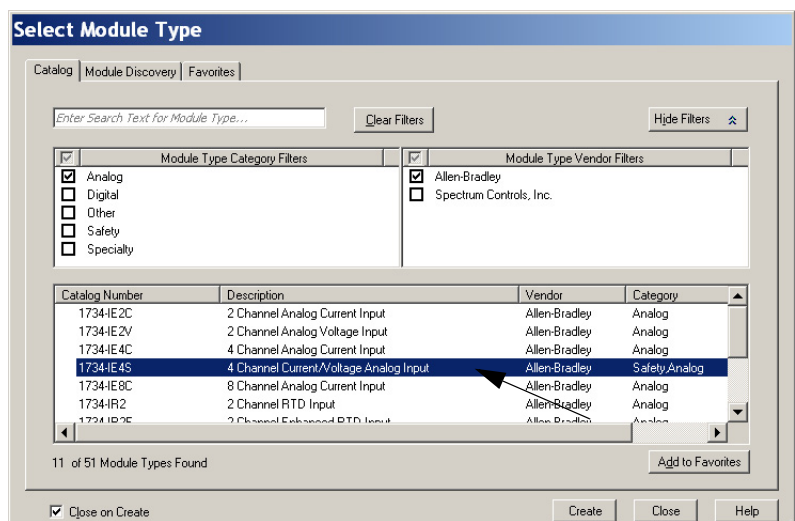
### Add the Safety Analog Input Module

Follow these steps to add the POINT Guard I/O safety analog input module.

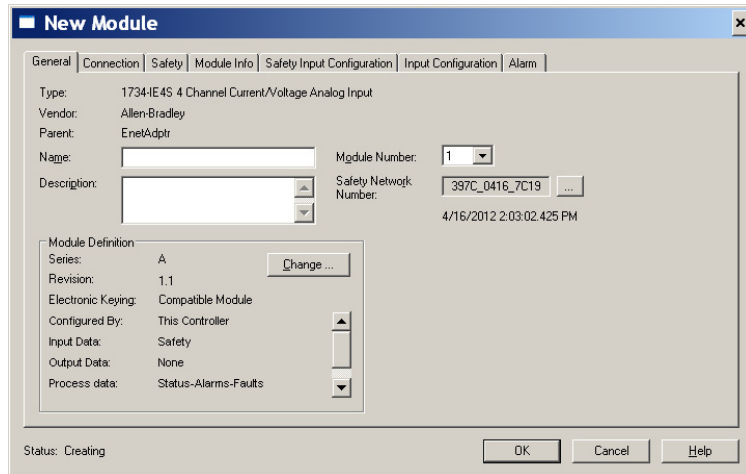
- Right-click the POINT I/O Chassis and choose New Module.



- From the Select Module dialog box, select an analog input module and click Create.



3. Specify the general properties of the module.

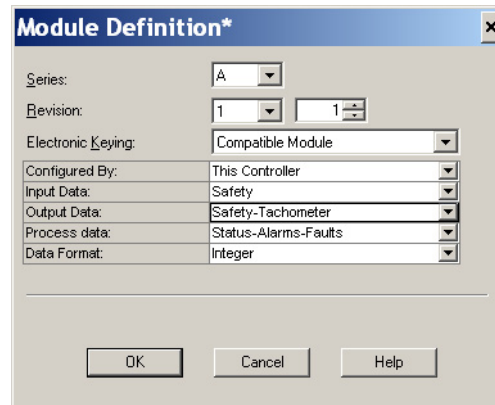


- a. In the Name field of the New Module dialog box, type a unique name for the analog input module.
- b. From the Module Number pull-down menu, choose a unique module number that corresponds to the position of the module in the chassis.
- c. In the Description field, type a description, if desired.
- d. In the Safety Network Number field, use the default setting.

For a detailed explanation of the safety network number (SNN), see the GuardLogix Controller Systems Safety Reference Manuals that are listed in the Additional Resources on [page 10](#). In most cases, you use the default that is provided by the Logix Designer application.

The safety network number (SNN) is a unique number that identifies a safety subnet. We suggest that all safety modules on a network have the same SNN, to make documentation easier. During configuration, the Logix Designer application defaults the SNN of a safety device to match the SNN of the lowest safety node on the network.

4. To open the Module Definition dialog box, click Change.



- a. In the Series field, choose the series letter of the analog input module.
- b. In the Revision fields, choose the revision number of the module.

- c. From the Electronic Keying pull-down menu, choose the appropriate keying method for the input module.

Choose	Description
Exact Match	All parameters must match or the inserted module rejects a connection to the controller.
Compatible Module	Allows an I/O module to determine whether it can emulate the module that is defined in the configuration that is sent from the controller.

- d. From the Configured By pull-down menu, choose the appropriate method by which this module is configured.

Choose	Description
This Controller	This selection directs the controller to configure the Inputs.
External Means	This selection directs the controller to establish a safety input connection only, and the controller does not configure the module.

- e. From the Input Data pull-down menu, choose Safety.  
 f. From the Output Data pull-down menu, choose from the following.

Choose	Description
None	An output tag is not generated.
Safety-Tachometer	This option is available when the Configured By selection is This Controller. The output tag contains data members for safety output data that is needed for Tachometer mode. If you are using Tachometer mode, you must choose this setting; otherwise, you are not able to configure other Tachometer parameters.

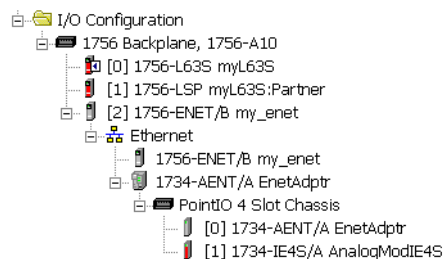
- g. From the Process Data pull-down menu, choose from the following.

Choose	Description
Status	The input tag contains safety analog input data from the module.
Status - Alarms	These tags are created for the target module: <ul style="list-style-type: none"> <li>• Safety data for individual process alarms</li> <li>• Safety data for safety analog inputs from the module</li> </ul>
Status - Alarms - Faults	These tags are created for the target module: <ul style="list-style-type: none"> <li>• Safety data for individual process alarms</li> <li>• Safety data for faults</li> <li>• Safety data for safety analog inputs from the module</li> </ul>

- h. From the Data Format pull-down menu, use the default 'Integer'.

- Click OK to return to the Module Properties dialog box.
- Click OK again to apply your changes.

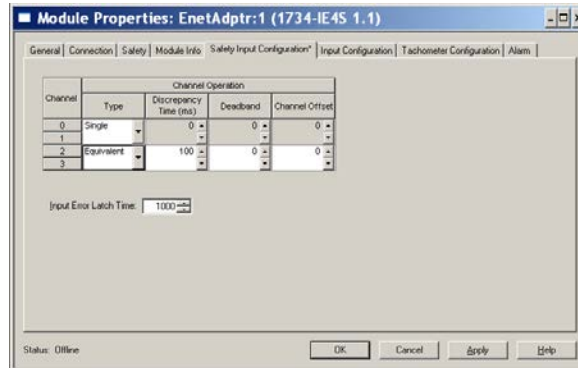
The I/O Configuration tree displays the 1734-IE4S module.



## Configure the Safety Analog Input Channel Operation

To configure the safety analog input channels, follow this procedure.

1. From the Module Properties dialog box, click the Safety Input Configuration tab.



2. Assign the Operation Type.

Choose	Description
Single	Inputs are treated as single channels. Dual-channel safety inputs can be configured as two individual, single channels. <b>IMPORTANT:</b> Use single-channel mode when you intend to use the GuardLogix safety application instructions.
Equivalent	Inputs are treated as a dual-channel equivalent pair. The channels must match within the discrepancy time or an error is generated.

**IMPORTANT** If you are using a Dual-channel Analog (DCA) safety instruction in your application program, you must configure the 1734-IE4S module for single-channel operation. Analog input pairs are then evaluated as pairs and compared to each other in the application logic.

3. If you chose Equivalent, you must also assign a Discrepancy Time, from 0...65,530 ms in 10 ms increments.

This measurement is the amount of time the two channels can differ from each other (larger than the deadband value) before a discrepancy error is declared. A discrepancy time setting of 0 ms means that the channels in a dual configuration can be discrepant for an infinite amount of time without a fault being declared. This setting would effectively eliminate the usefulness of dual channel mode.

4. Configure a deadband for the paired safety analog inputs.

The deadband can be any value from 0...32767 (engineering units) in increments of 1. When the paired input values exceed the deadband tolerance for longer than the Discrepancy Time, a discrepancy fault occurs.

**TIP** Configure a deadband value for applications that use two sensors to measure the same variable; otherwise, spurious trips can occur.

5. If desired, configure a Channel Offset for the paired safety analog inputs.

The channel offset can be any value from -32768...32767 (engineering units) in increments of 1. Configure an offset when differences in the sensors nominal input signals would otherwise exceed the desired deadband. The channel offset is applied from the second to the first member of the channel pair, that is, from channel 1 to channel 0 or from channel 3 to channel 2.

- In the Input Error Latch Time field, enter the time that the module holds an error to make sure that the controller can detect it (0...65,530 ms, in increments of 10 ms - default 1000 ms).

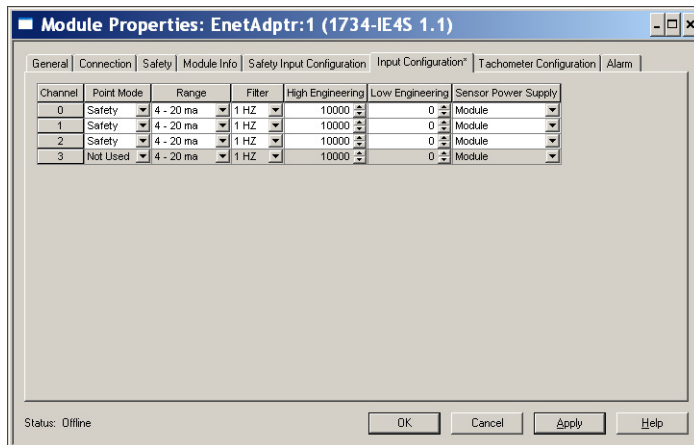
This setting provides more accurate diagnostics. The purpose for latching input errors is to make sure that intermittent faults that can exist only for a few milliseconds are latched long enough for the controller to read. The amount of time to latch the errors must be based on the RPI, the safety task watchdog, and other application-specific variables.

- Click Apply.

## Configure the Safety Analog Inputs

To configure the analog input points, follow these steps.

- From the Module Properties dialog box, click the Input Configuration tab.



- Assign the Point Mode.

Choose	Description
Not Used	The input is disabled.
Safety	Safety-related analog input value
Standard	Standard analog input value, not being used for a safety function

If the channel operation is configured as dual-channel equivalent, when you click Apply, channel 1 is set to the same value as channel 0 and channel 3 is set to the same value as channel 2.

- Configure the module for current, voltage, or tachometer inputs.

**4. Configure an input filter.**

A single-pole, anti-aliasing filter of 10 Hz is followed by a four-pole digital filter. Choose from the following available corner frequencies.

- 1 Hz (recommended for Tachometer mode)
- 5 Hz
- 10 Hz
- 50 Hz

For more information on the filter frequencies and step response, see the technical specifications for the 1734-IE4S module on page [176](#) or [Digital Input Filter on page 30](#).

**5. Assign High and Low Engineering scaling values for the inputs, if desired.**

The valid range for both the High and Low Engineering settings is -30000...30000, in increments of 1. Scaling lets the module report in engineering units such as degrees, PSI, CFM, and percent, rather than in raw counts.

If the channel operation is configured as dual channel equivalent, when you click Apply, channel 1 is set to the same value as channel 0 and channel 3 is set to the same value as channel 2 if the channel operation is configured as dual channel equivalent.

**6. To indicate how each sensor is powered, set the Sensor Power Supply value to External or Module.**

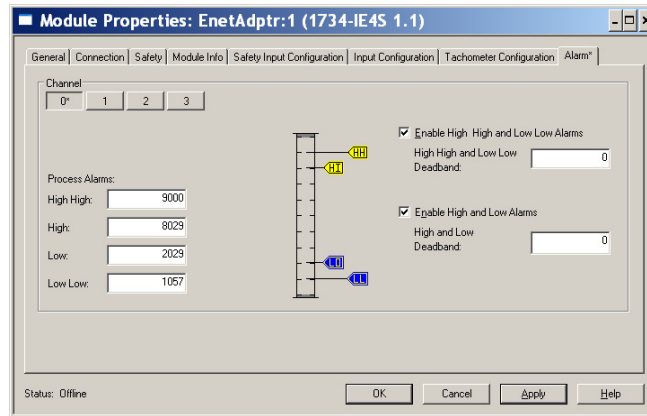
**TIP** Set this value to Module to supply power to the sensors connected to the POINT Guard Analog Input module. This value allows the module to detect a loss of sensor power.

## Configure Safety Analog Input Alarms (Optional)

**TIP** If you are using a Dual-channel Analog (DCA) safety instruction in your application program, we recommend that you do not configure these values on the module. Instead, to facilitate troubleshooting, use the application program to check for high and low alarm values via the Dual-Channel Analog Input instruction or other data comparison instructions.

To configure alarms for each of the safety analog input channels, follow these steps.

1. From the Module Properties dialog box, click the Alarm tab.



2. To configure each channel, click 0, 1, 2, or 3, as appropriate.
3. To enable the alarm, check the boxes:
  - Enable High High - Low Low Alarms
  - Enable High - Low Alarms
4. Type the alarm values from -32768...32767 in the appropriate fields, following these guidelines:
  - The High High alarm value must be greater than or equal to the High alarm value.
  - The High alarm value must be greater than the Low alarm value.
  - The Low Low alarm value must be less than or equal to the Low alarm value.
  - These values are based on the engineering units that are configured on [page 99](#).
5. Configure a deadband value for the High High - Low Low alarms and High - Low alarms, if desired.

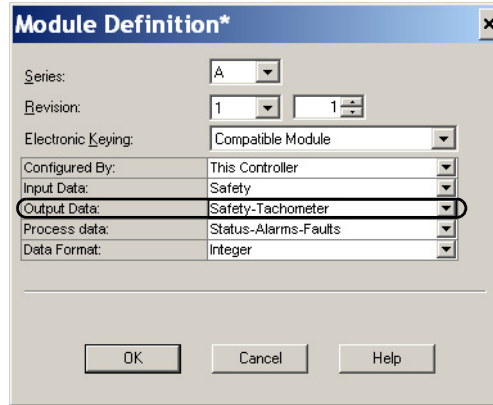
The valid range is 0...32767. The deadband lets the alarm status bit remain set, despite the alarm condition disappearing, as long as the input data remains within the deadband of the alarm. These values are based on the Engineering units that are configured on [page 99](#).

For more information on this feature, see [Process Alarms on page 31](#)



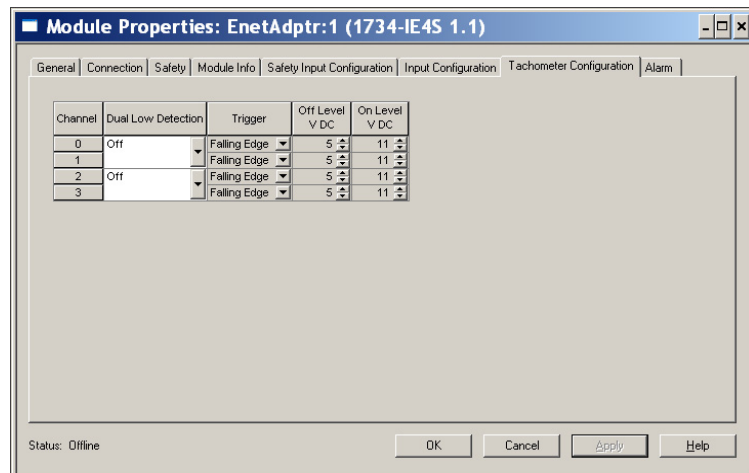
## Configure Tachometer Operation

You can only configure the module for tachometer operation if your Module Definition includes Output Data for Safety-Tachometer.



Follow these steps to define how the module operates in Tachometer mode.

1. From the Module Properties dialog box, click the Tachometer Configuration tab.



2. Turn Dual Low Detection ON or OFF for each channel pair.

To increase the diagnostic coverage of your speed sensing loop, you must determine whether the two tachometer sensors you are using to sense speed are shorted together. That is, you must be able to detect a channel-to-channel fault. One method is to implement two tachometer sensors so that, during normal operation, their pulse trains are never low simultaneously. When Dual Low Detection is ON, the module detects this condition as a fault. This fault indicates that the two sensors are shorted together.

To use this feature, you must use Channels 0 and 1 together, and Channels 2 and 3 together. Channels 0 and 1 have the same setting and channels 2 and 3 have the same setting.

3. Configure the Trigger to indicate if the module channels must count pulses on the rising edge or falling edge.

When the module is configured as Dual, channels 0 and 1 have the same setting and channels 2 and 3 have the same setting.

4. Specify a tachometer Off Level in volts for each channel.

This level is the voltage at which the module considers the tachometer sensor to be OFF for tachometer speed calculation purposes.

The valid range is 0...23V in increments of 1V. The default setting of 5V must be satisfactory for a 0...24V DC signal. For a 0...5V DC signal, a setting of 1V is recommended.

See [Off and On Signal Levels on page 35](#) for more information on the Off and On Levels.

When the module is configured as Dual Channel Equivalent, channels 0 and 1 have the same setting and channels 2 and 3 have the same setting.

5. Specify a tachometer On Level in volts for each channel.

This level is the voltage at which the module considers the tachometer sensor to be ON for tachometer speed calculation purposes

The valid range is 1...24V in increments of 1V. The default setting of 11V must be satisfactory for a 0...24V DC signal. For a 0...5V DC signal, a setting of 4V is recommended.

See [Off and On Signal Levels on page 35](#) for more information on the Off and On Levels.

When the module is configured as dual-channel Equivalent, channels 0 and 1 have the same setting and channels 2 and 3 have the same setting. The tachometer On Level must be greater than the tachometer Off Level.

## Values and States of Tags

This table shows the values and states of the tags.

Data		Description
Digital Input Data	Run Mode STANDARD	Indicates whether consumed data is actively being updated by a device that is in one of these states: • Run mode: 1 Idle State: 0
	Connection Faulted STANDARD	Indicates the validity of the safety connection between the safety producer and the safety consumer. • Valid: 0 Faulted: 1
	Safety Input Data SAFETY	Indicates the ON/OFF state of each input circuit. • ON: 1 OFF: 0
	Combined Safety Input Status SAFETY	An AND of the status of all input circuits. • All circuits are normal: 1 • An error was detected in one or more input circuits: 0
	Individual Safety Input Status SAFETY	Indicates the status of each input circuit. • Normal: 1 Fault (Alarm): 0
	Combined Safety Output Status SAFETY	An AND of the status of all safety output circuits. • All circuits are normal: 1 • An error has been detected in one or more output circuits: 0
	Individual Safety Output Status SAFETY	Indicates the status of each safety output circuit. • Normal: 1 Fault (Alarm): 0
	Muting Lamp Status SAFETY	Indicates the status when circuits T1 and T3 are configured as the muting lamp output. • Normal: 1 Fault (Alarm): 0
	Output Readback STANDARD	Monitors the presence of 24V on the output circuit. Readback is ON (1) if 24V is on output terminal. • ON: 1 OFF: 0
	Individual Test Output Status STANDARD	Indicates the status of each of the test output circuits. • Normal: 1 Fault (Alarm): 0
	Input Power Error Bit STANDARD	Indicates field power that is supplied is within specification. • Power error: 1 Power OK: 0
Output Power Error Bit STANDARD	Indicates field power that is supplied is within specification. • Power error: 1 Power OK: 0	
Digital Output Data	Safety Output Data SAFETY	Controls the safety output. • ON: 1 OFF: 0
	Standard Output Data STANDARD	Controls the test output when Test Output mode is set to a standard output. • ON: 1 OFF: 0

Data		Description
Analog Input Data	Run Mode STANDARD	Indicates whether consumed data is actively being updated by a device that is in one of these states: <ul style="list-style-type: none"> <li>Run mode: 1 Idle State: 0</li> </ul>
	Connection Faulted STANDARD	Indicates the validity of the safety connection between the safety producer and the safety consumer. <ul style="list-style-type: none"> <li>Valid: 0 Faulted: 1</li> </ul>
	Safety Input Data SAFETY	Value of analog input data
	Individual Safety Input Status SAFETY	Indicates the status of each safety input circuit. Normal: 1 Fault (Alarm): 0
	Individual Status - Process Alarms STANDARD	Indicates whether each Safety Input Data value of a channel is between the configured High and Low Alarm values. Normal: 1 Alarm: 0
	Individual Status - Fault Reason STANDARD	Input Point Fault Reason
	Individual HH Alarm Status STANDARD	Individual High High Alarm Status Normal: 1 Alarm: 0
	Individual H Alarm Status STANDARD	Individual High Alarm Status Normal: 1 Alarm: 0
	Individual L Alarm Status STANDARD	Individual Low Alarm Status Normal: 1 Alarm: 0
	Individual LL Alarm Status STANDARD	Individual Low Low Alarm Status Normal: 1 Alarm: 0
	Individual Tachometer Overfrequency SAFETY	When the input is configured for Tachometer mode, this data indicates an overfrequency condition; that is, when pulses are faster than 1000 Hz. Normal: 1 Fault: 0
	Individual Tachometer Under-frequency SAFETY	When the input is configured for Tachometer mode, this data indicates an under-frequency condition; that is, when pulses are slower than 1 Hz. Normal: 1 Fault: 0
	Individual Tachometer Dual Low SAFETY	Indicates that both channels are low when the input is configured for Tachometer mode. Normal: 1 Fault: 0
	Input Power STANDARD	Indicates that input power over- or underrange. Normal: 1 Fault: 0
Analog Output Data	Reset Tachometer SAFETY	Resets a latched overfrequency condition and enables the module to begin calculating frequency again. <ul style="list-style-type: none"> <li>No reset: 0 Reset: 1</li> </ul>

**IMPORTANT** In the previous table, 'SAFETY' denotes information the controller can use in safety-related functions. 'STANDARD' denotes additional information that must not be directly used for safety functions.

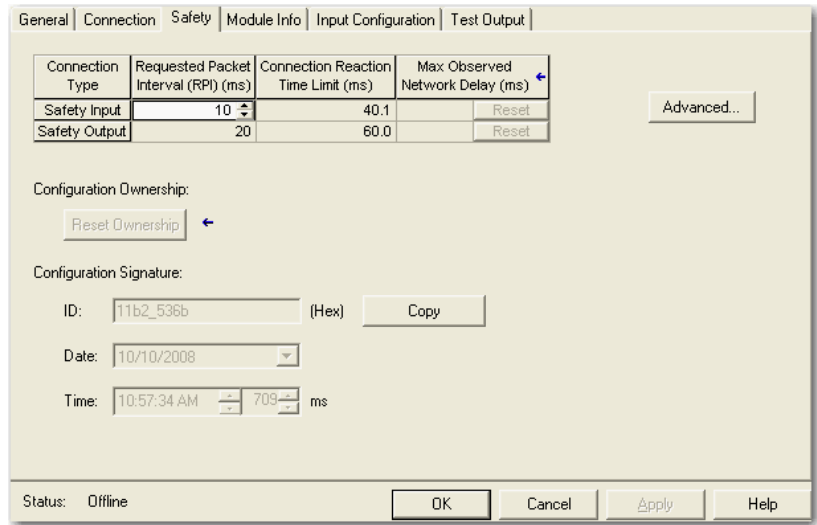


**ATTENTION:** Do not rely on data readback to detect faults. You must monitor status bits to detect faults.

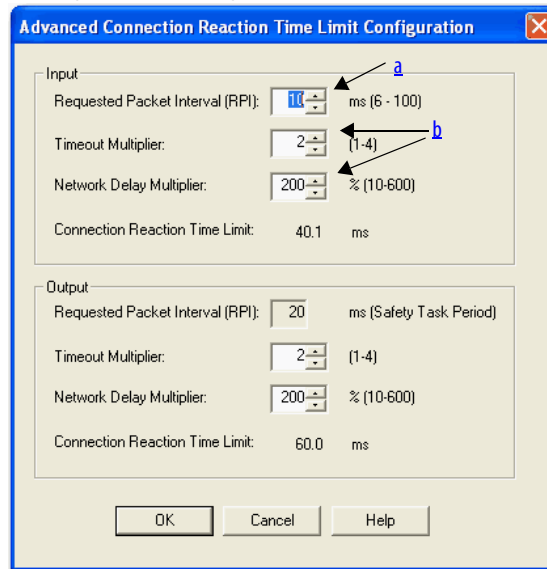
## Configure Safety Connections

To configure the safety input connection of the module, follow these steps.

1. From the Module Properties dialog box, click the Safety tab.



2. Click Advanced to open the Advanced Connection Reaction Time Limit Configuration dialog box.



- a. In the Requested Packet Interval (RPI) field, enter the input connection RPI to support your application (6...500 ms).

The smallest input RPI allowed is 6 ms. When you select small RPIs, it consumes network bandwidth and can cause nuisance trips because other devices cannot get access to the network.

As an example, a safety input module with only E-stop switches connected works well with settings of 50...100 ms. An input module with a light curtain guarding a hazard needs the fastest response possible. When you select appropriate RPIs, the system has maximum performance.

- b. Use the default values for Timeout Multiplier (2) and Network Delay Multiplier (200).

**IMPORTANT** To determine what is appropriate, analyze each safety channel. The default Timeout Multiplier of 2 and Network Delay Multiplier of 200 creates a worst-case input connection-reaction time limit of 4 times the RPI, and an output connection-reaction time limit of 3 times the RPI. Changes to these parameters must be approved only after a thorough review by a safety administrator.

A connection status tag exists for every connection.

[-] AENT_Adapter:1:I	{...}	{...}		AB:1734_IB8S_Safety5:I:0	Safety
AENT_Adapter:1:I.RunMode	0		Decimal	BOOL	Safety
AENT_Adapter:1:I.ConnectionFaulted	0		Decimal	BOOL	Safety
AENT_Adapter:1:I.P100Data	0		Decimal	BOOL	Safety
AENT_Adapter:1:I.P101Data	0		Decimal	BOOL	Safety
AENT_Adapter:1:I.P102Data	0		Decimal	BOOL	Safety
AENT_Adapter:1:I.P103Data	0		Decimal	BOOL	Safety
AENT_Adapter:1:I.P104Data	0		Decimal	BOOL	Safety
AENT_Adapter:1:I.P105Data	0		Decimal	BOOL	Safety
AENT_Adapter:1:I.P106Data	0		Decimal	BOOL	Safety
AENT_Adapter:1:I.P107Data	0		Decimal	BOOL	Safety

If the RPI and connection reaction time limit for the network are set appropriately, then this status tag must always remain low. Monitor all connection status bits to verify that they are not going high intermittently due to timeouts.

For more information about the Advanced Connection Reaction Time Limit Configuration dialog box, see the user manual for your controller. See [Additional Resources on page 10](#).

## Configuration Ownership

The connection between the owner and the POINT Guard I/O module is based on the following:

- POINT Guard I/O module number
- POINT Guard I/O safety network number
- GuardLogix slot number
- GuardLogix safety network number
- Path from the GuardLogix controller to the POINT Guard I/O module
- Configuration signature

If any differences are detected, the connection between the GuardLogix controller and the POINT Guard I/O module is lost, and the yellow yield icon appears in the controller project tree.

For more information, see [Replacing POINT Guard I/O Modules on page 145](#).

## Save and Download the Module Configuration

After you configure a module, it is recommended that you save and download the configuration.

If, after downloading the program, the MS and NS status indicators on the POINT Guard I/O module are not both solid green, a loss of ownership potentially occurred. A yellow yield icon in the project tree also indicates a loss of ownership. For more information, see [Chapter 8](#).

## Update POINT Guard I/O Modules

---

**IMPORTANT** When you use ControlFLASH™ software to update a module, the software stops a running safety I/O connection. You must inhibit I/O connections before updating a POINT Guard I/O module.

---

In addition, the 1734-IE4S safety analog input module requires field power to be applied while updating the firmware of the module. If a ControlFLASH update fails, check the ControlFLASH log by clicking View Log on the Update Status dialog box.

If the last message is '[FAILURE] Update: Error #11001: Unknown General Status error code received. GS = 0xD0, ES = 0x0001,' verify that field power is connected to the module and restart the download.

**TIP** The module receives its field power from the 24V DC connection to the power supply feeding it, for example a 1734-AENT, 1734-FPD, or 1734-EP24DC module. Make sure that 24V DC power is connected to these modules before performing a flash update of the 1734-IE4S.

**Notes:**

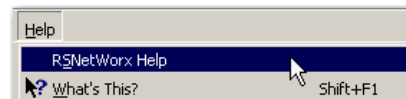


## Configure the Module for a SmartGuard Controller

Topic	Page
Before You Begin	110
Set the Node Address	110
Auto-addressing with a 1734-PDN Adapter	112
Set Up Your DeviceNet Network	114
Configure the POINT Guard I/O Modules	115
Configure the SmartGuard Controller	124
Save and Download Module Configuration	129

This chapter provides information about how to configure a SmartGuard™ controller and POINT Guard I/O™ modules by using USB (Universal Serial Bus) connectivity. See the corresponding RSNetWorx™ for DeviceNet software help files for network-configurator operating procedures.

**TIP** For information about RSNetWorx for DeviceNet software, from the Help menu, choose RSNetWorx Help.



## Before You Begin

Confirm that you have these required items:

- RSNetWorx for DeviceNet software

Cat. No.	Required Version
1734-IB85, 1734-OB85	9 or later
1734-IE4S	10 or later
1734-OBV2S	21 or later

- RSLinx® software, version 2.51 or later
- SmartGuard USB driver  
The SmartGuard USB driver is already be in your RSLinx® software. If it is not, load the driver onto your computer, and be aware of the folder location as you browse to it later.
- 1734-PDN adapter
- SmartGuard controller and POINT Guard I/O module EDS files

Load the proper electronic data sheet (EDS) files by using the EDS Hardware Installation Tool at <http://www.rockwellautomation.com/resources/eds/>.

Include your 1752 SmartGuard controller and POINT Guard I/O modules.

Cat. No.	EDS File
1734-IB85	00010023000F0100 (Series A) 00010023000F0200 (Series B)
1734-OB85	0001002300100100 (Series A) 0001002300100200 (Series B)
1734-OBV2S	0001002300200100
1734-IE4S	0001002A00010100

## Set the Node Address

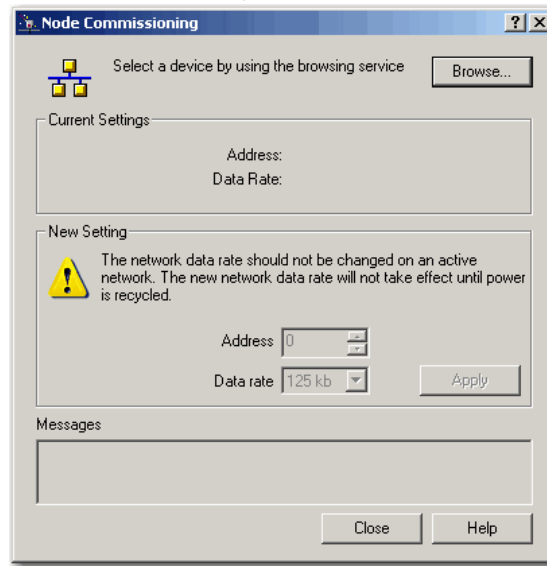
Use RSNetWorx for DeviceNet software to set the node address of POINT Guard I/O modules. The module has an out-of-box preset node address of 63. We suggest that you connect and set the modules one at a time. Otherwise, the address conflicts (all of them at 63) prevents communication with some of the modules.

### IMPORTANT

The unique identifier for a safety node is a combination of the safety network number (SNN) and node address. When the SNN is set, the current node address is used to generate and store this identifier in nonvolatile memory. Once the identifier is set, for safety reasons, the node address cannot be changed unless specific action is taken to reset the POINT Guard I/O SSN of the module. For this reason, you are required to set the node address before the application of an SNN.

Follow these steps to set the node address with the node commissioning tool.

1. Choose Start>Programs>Rockwell Software>RSNetWorx>DeviceNet Node Commissioning Tool.



2. Click Browse.



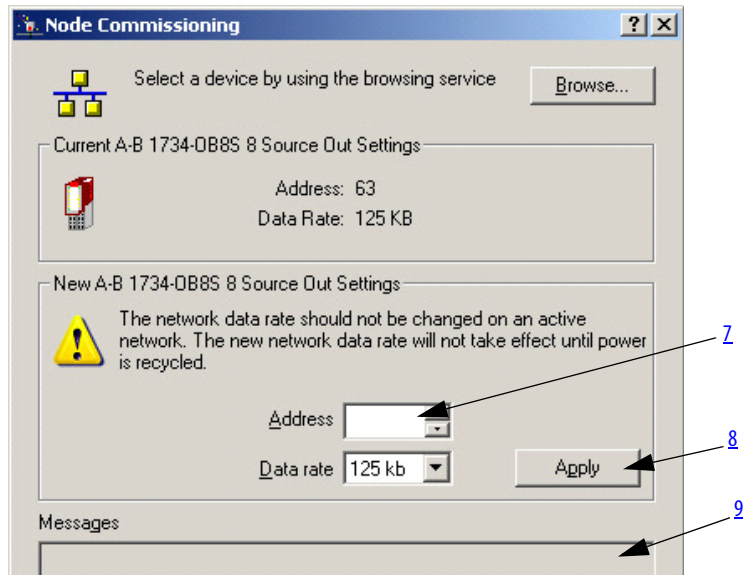
3. Check 'I want to input the address for the device on the selected network'.
4. Browse to the DeviceNet network, and do not click OK when the browse is complete.

If you are unable to browse the DeviceNet network and see the POINT Guard modules, the modules were potentially configured to an incompatible data rate or node address. Attempt to add these modules on an isolated network to determine the node address and data rate.

5. Enter the current address for the device.

An out-of-box device uses address 63.

6. Click OK



7. Enter the new address for the device.
8. Click Apply.
9. Look for confirmation in the messages section.

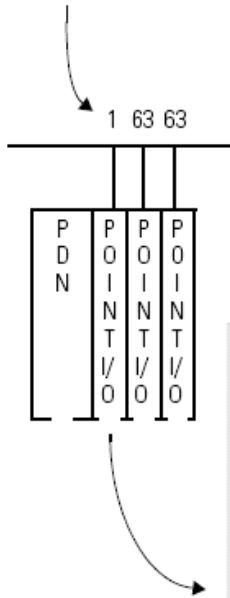
## Auto-addressing with a 1734-PDN Adapter

With sequential auto-addressing, the leftmost node address is configured and a parameter is set in that module to automatically assign addresses to the nodes that reside to the right of the module. The leftmost node can be a POINT Guard I/O module or a standard POINT I/O module.

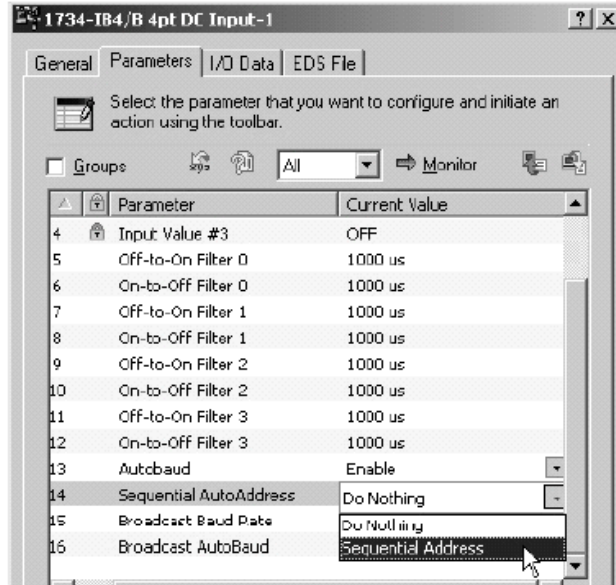
Follow these steps to use the auto-address feature.

1. Reset any modules that you are not sure are out-of-box.
2. Attach the first module to the 1734-PDN adapter.
3. Use the node commissioning tool to set the node address of this module.
4. Attach the additional nodes to the right of the module that is used in steps 2 and 3.
5. Perform the auto-address feature on the module that is used in steps 2 and 3.

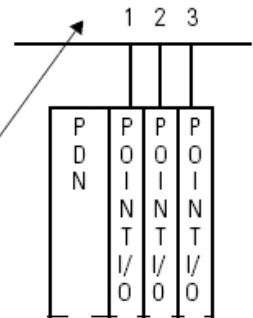
A. Set the address of the leftmost I/O module.



B. When you configure the leftmost module, set Sequential AutoAddress to 'Sequential Address'.



The module sequences the rest of the modules to its right in the group.



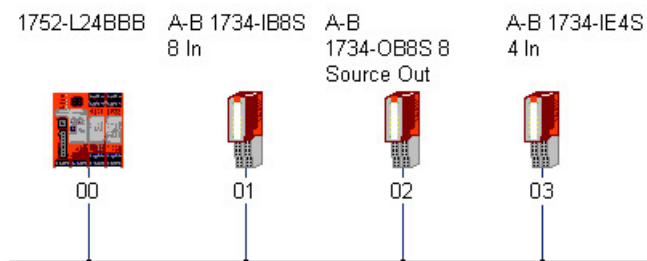
## Set Up Your DeviceNet Network

Before you begin to design a project with RSNetWorx for DeviceNet software, follow these procedures.

1. From RSLinx software, open RSWho and select the SmartGuard driver.

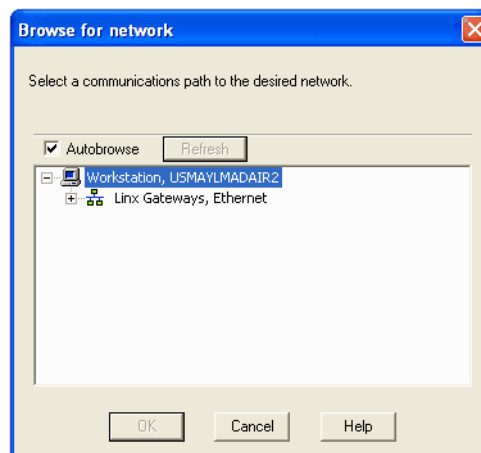
RSWho browses the DeviceNet network that is connected to the SmartGuard controller.

In this example, three POINT Guard I/O modules are connected to the SmartGuard controller.

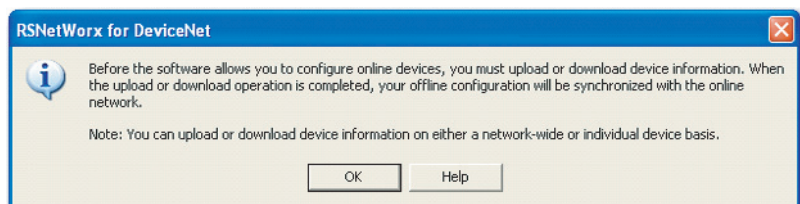


If RSLinx software finds the nodes on the DeviceNet network, RSNetWorx for DeviceNet software also finds the nodes.

2. Open RSNetWorx for DeviceNet software.
3. From the Networks menu, choose Online.

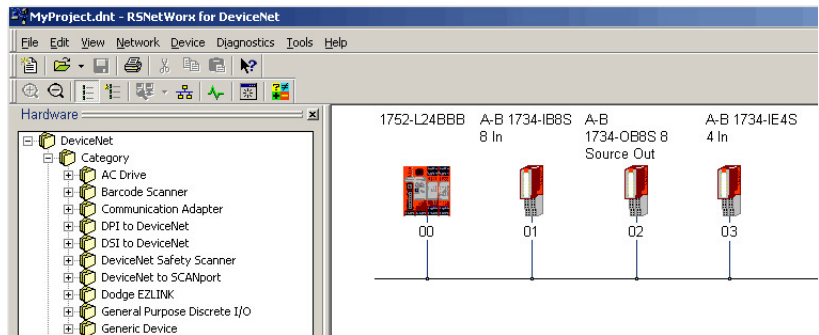


4. Select the SmartGuard driver and click OK.



5. Click OK.

RSNetWorx for DeviceNet software finds the SmartGuard and POINT Guard I/O modules on the DeviceNet network.



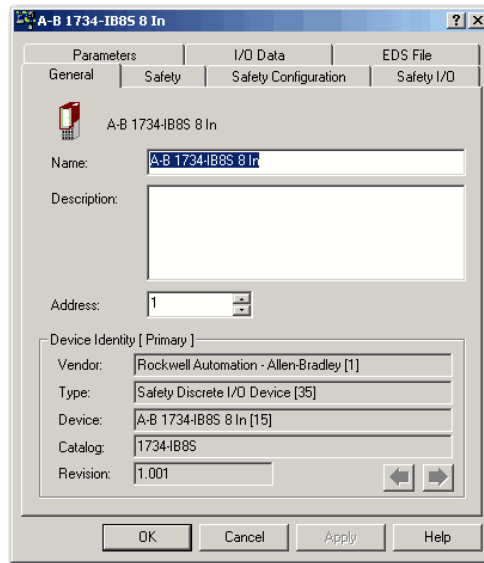
6. Click the online icon again to go offline.

## Configure the POINT Guard I/O Modules

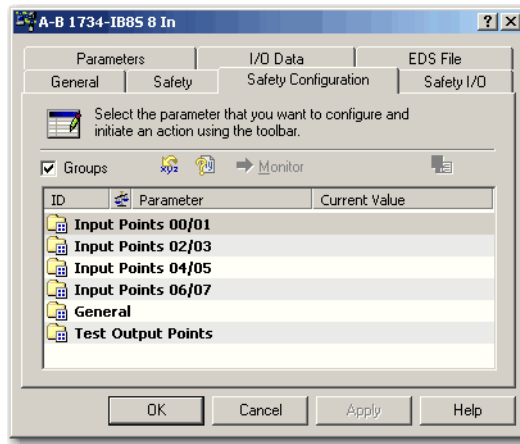
From the Safety Configuration tab, you can configure the safety inputs and outputs of the module.

### Configure Digital Safety Inputs and Test Outputs

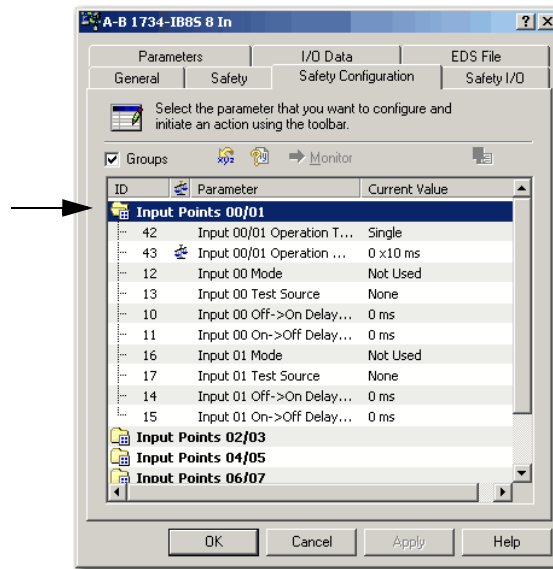
1. To open the Properties dialog box, double-click the POINT Guard I/O digital input module .



2. Click the Safety Configuration tab.



3. Double-click each set of input points to edit their configuration.

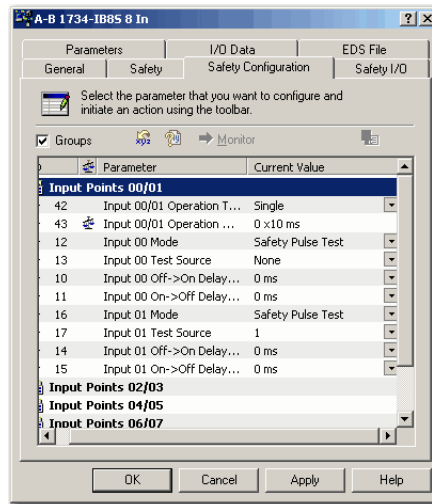


Parameter Name	Value	Description	Default
Input Point Operation Type	Single Channel	Use as single channel.	Single
	Dual-channel Equivalent	Use as dual-channel. Normal when both channels are ON or OFF.	
	Dual-channel Complementary	Use as dual-channel. Normal when one channel is ON and the other channel is OFF.	
Input Point Mode	Not Used	External input device is not connected.	Not Used
	Safety Pulse Test	Use with a contact output device and in combination with a test output. When you use this setting, short-circuits between input signal lines and the power supply (positive side) and short-circuits between input signal lines can be detected.	
	Safety	A solid-state output safety sensor is connected.	
	Standard	A standard device, such as a reset switch, is connected.	



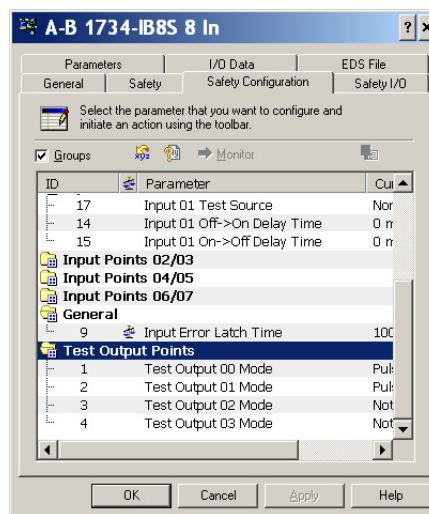
Parameter Name	Value	Description	Default
Safety Input Test Source	None	The test output that is used with the input.	None
	Test Output 0		
	Test Output 1		
	Test Output 2		
	Test Output 3		
Input Delay Time Off -> On	0 ... 126 ms (in 6 ms increments)	Filter time for OFF to ON transition.	0 ms
Input Delay Time On -> Off	0 ... 126 ms (in 6 ms increments)	Filter time for ON to OFF transition.	0 ms

- If you are pulse-testing the module, edit the parameters so that the channels are pulse tested by Test sources 0 and 1, respectively.



- Double-click General to edit the Input Error Latch Time, if desired.

The default value is 1000 ms.



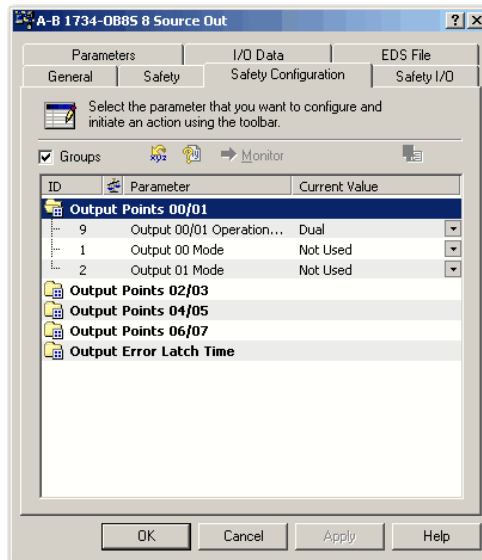
6. Double-click Test Output Points to edit their configuration.

Parameter Name	Value	Description	Default
Test Output Mode	Not Used	An external device is not connected.	Not Used
	Standard	The output is connected to a standard device.	
	Pulse Test	A contact output device is connected. Use in combination with a safety input.	
	Power Supply	The power supply of a Safety Sensor is connected. The voltage that is supplied to I/O power (V, G) is output from the test output terminal.	
	Muting Lamp Output (Terminal T1 or T3 only)	An indicator is connected and turned ON to detect broken lines in an external indicator.	

7. Click Apply and OK.

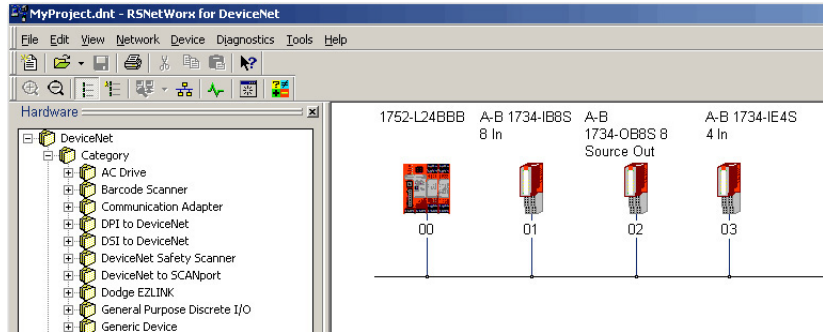
### Configure Digital Safety Outputs

1. To display the parameters for editing, double-click each group of Outputs Points.



Parameter Name	Value	Description	Default
Output Point Mode	Not Used	An external output device is not connected.	Not Used
	Safety	When the output is ON, the test pulse is not output (remains ON).	
	Safety Pulse Test	When you use this function, short-circuits between output signal lines and the power supply (positive side) and short-circuits between output signal lines can be detected.	
Output Point Operation Type	Single Channel	Use as single channel.	Dual-channel
	Dual-channel	Use as dual-channel. When both channels are normal, outputs can be turned ON.	
Safety Output Error Latch Time	0 . . 65,530 ms (in 10 ms increments)	Safety output errors are latched for this time.	1000 ms

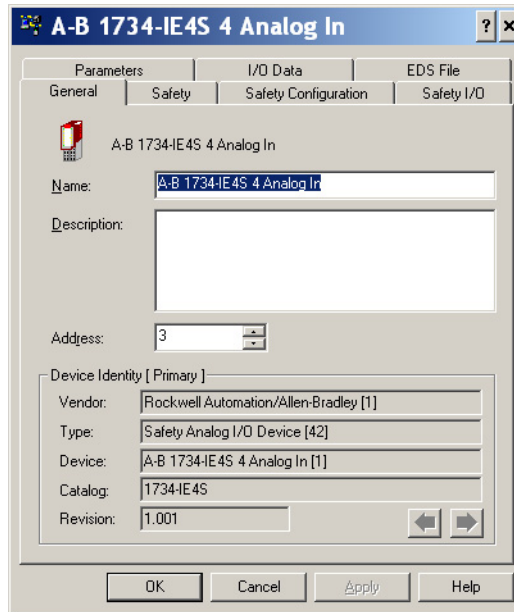
2. To change from the default value (1000 ms), if desired, double-click Output Error Latch Time.
3. Click Apply and OK to return to the main RSNetWorx for DeviceNet dialog box.



## Configure Safety Analog Inputs

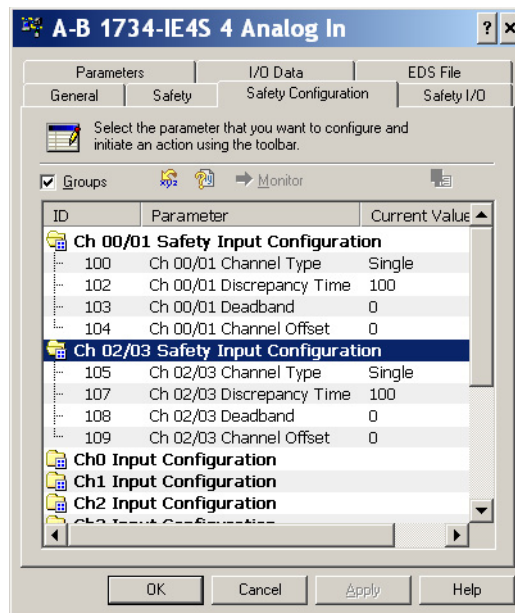
To configure a 1734-IE4S module, follow these steps.

1. To open the Properties dialog box, double-click the POINT Guard I/O analog module.



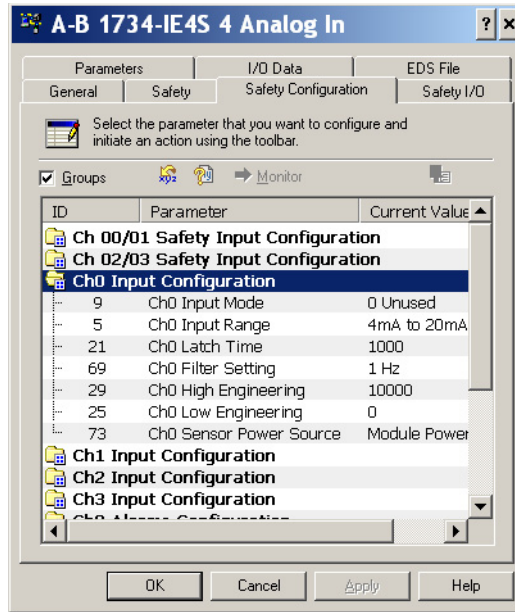
2. Click the Safety Configuration tab.

- To display the parameters for editing, double-click each group of Dual Channel Safety Inputs.



Parameter Name	Value	Description	Default
Channel type	Single	Inputs are treated as single channels. Dual-channel safety inputs can be configured as two individual, single channels.	Single
	Equivalent	Inputs are treated as a dual-channel equivalent pair. The channels must match within the discrepancy time or an error is generated.	
Discrepancy time	0...65,530 (in 10 ms increments)	When Dual Channel mode is selected, this value is the amount of time the two channels can differ from each other (larger than the deadband value) before a discrepancy error is declared. A discrepancy time setting of 0 ms means that the channels in a dual configuration can be discrepant for an infinite amount of time without a fault being declared, effectively eliminating the usefulness of dual channel mode.	100 ms
Discrepancy deadband	0...32767 (in engineering units)	In Dual Channel mode, when the paired input values exceed the deadband tolerance for longer than the Discrepancy Time, a discrepancy fault occurs.  <b>TIP</b> Configure a deadband value for applications that use two sensors to measure the same variable; otherwise, spurious trips can occur.	0
Channel offset	-32768...32767 (in engineering units)	Offset value for dual channel mode only. Configure an offset when differences in the sensors nominal input signals would otherwise exceed the desired deadband.	0

- To display the parameters for editing, double-click each Channel Safety Configuration group.

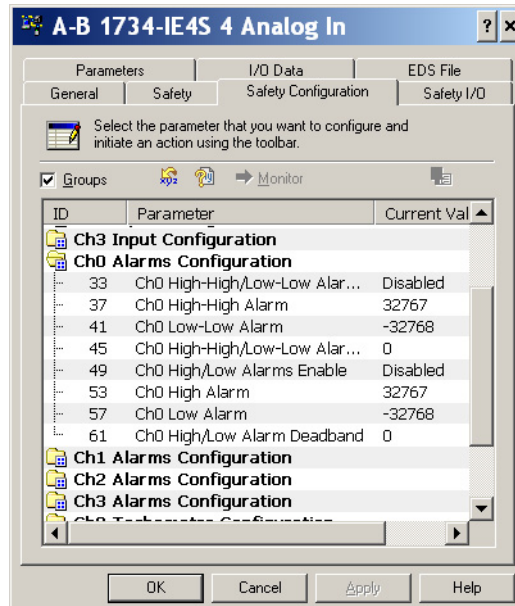


Parameter Name	Value	Description	Default
Input Mode	Not Used	External input device is not connected.	Not Used
	Safety	A solid-state safety sensor is connected.	
	Standard	A standard device is connected.	
Input Range	±10V	Input voltage range.	4...20 mA
	0...5V		
	0...10V		
	±5V		
	4...20 mA	Input current range.	
	0...20 mA		
	Tachometer	Tachometer mode.	
Latch Time	0...65,530 ms (in 10 ms increments)	Safety input errors are latched for this time so that the controller can read them and they are not missed if they clear themselves too quickly. One value for all channels.	1000
Filter Setting	1 Hz	A single-pole, anti-aliasing filter of 10 Hz is followed by a four-pole digital filter with these available frequencies. <sup>(1)</sup>	1 Hz
	5 Hz		
	10 Hz		
	50 Hz		
High Engineering	-30000...30000	Scaling value for inputs	10000 <sup>(2)</sup>
Low Engineering	-30000...30000	Scaling value for inputs	0
Sensor Power Source	External	An external power supply is used to power the analog sensors. Terminals S0...S3 on the module are not being used.	Module
	Module	Terminals S0...S3 on the module are being used to power the analog sensors. <b>TIP</b> Set this value to Module to supply power to the sensors connected to the POINT Guard Analog Input module. This setting allows the module to detect a loss of sensor power.	

(1) For more information on the filter frequencies and step response, see the technical specifications for the 1734-IE4S module, on page 176.

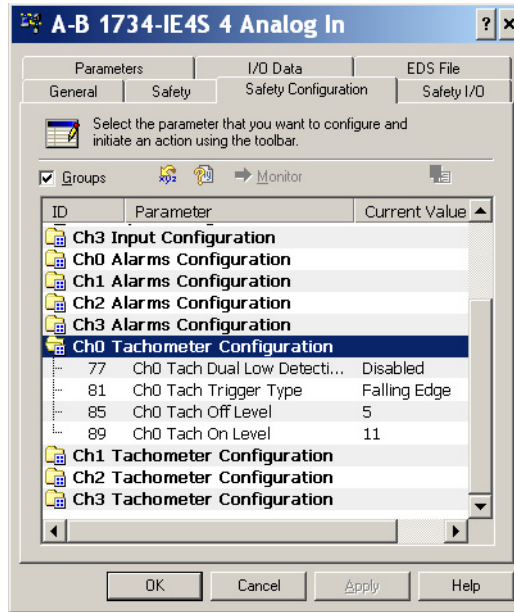
(2) 1000 for Tachometer mode.

- To display parameters for editing, double-click each Engineering Units Alarms group.



Parameter Name	Value	Description	Default
High High/Low Low Alarm Enable	Disable	Enable or disable alarms.	Disable
	Enable		
High High Alarm	-32768...32767	Follow these guidelines when setting the alarm values. <ul style="list-style-type: none"> <li>The High High alarm value must be greater than or equal to the High alarm value.</li> <li>The High alarm value must be greater than the Low alarm value.</li> <li>The Low Low alarm value must be less than or equal to the Low alarm value.</li> <li>These values are based on the Engineering units</li> </ul>	32767
Low Low Alarm	-32768...32767		0
High Alarm	-32768...32767		32767
Low Alarm	-32768...32767		0
High High/Low Low Alarm deadband	0...32767		Deadband on the High High and Low Low alarms.
High/Low Alarm deadband	0...32767	Deadband on the High and Low alarms.	0

- To display parameters for editing, double-click each Channel Tachometer Configuration group.



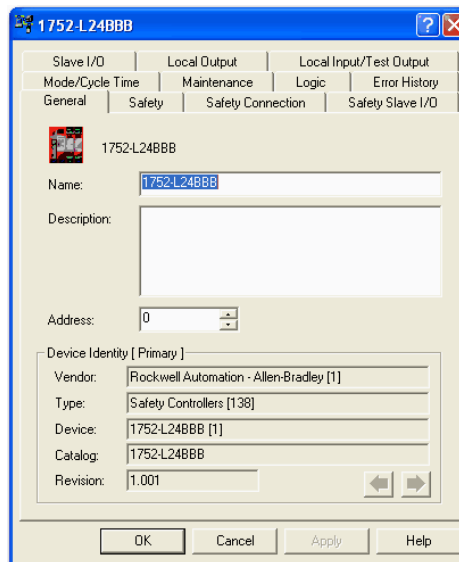
Parameter Name	Value	Description	Default
Tach Dual Low Detection	On	To increase the diagnostic coverage of your speed sensing loop, you must determine whether the two tachometer sensors you are using to sense speed are shorted together. That is, you must be able to detect a channel-to-channel fault. One method is to implement two tachometer sensors so that, during normal operation, their pulse trains are never low simultaneously. When Dual Low Detection is enabled, the module detects this condition as a fault, which indicates that the two sensors are shorted together.  To use this feature, you must use Channels 0 and 1 together, and Channels 2 and 3 together. Channels 0 and 1 have the same setting and channels 2 and 3 have the same setting. Both channels in the pair must use tachometer mode and the dual low detection diagnostic.	Disabled
	Off		
Tach Trigger Type	Falling edge (NPN)	Non-inverted input signal.	Falling edge
	Rising edge (PNP)	Inverted input signal.	
Tach Off Level	0 . . .23V (in 1 V increments)	This value is the voltage at which the module considers the tachometer sensor to be OFF for tachometer speed calculation purposes. The Tachometer Off Level must be less than the Tachometer On Level.	5V
Tach On Level	1 . . .24V (in 1 V increments)	This value is the voltage at which the module considers the tachometer sensor to be ON for tachometer speed calculation purposes. The Tachometer On Level must be greater than the Tachometer Off Level.	11V

## Configure the SmartGuard Controller

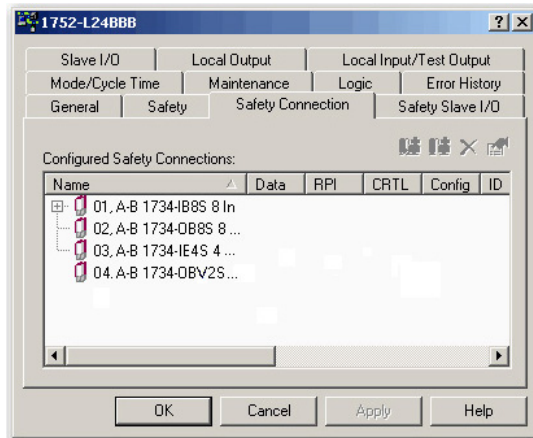
To configure input and output connections to the controller and complete the setup of the controller, follow the procedures in the next sections.

### Set Up the Input and Output Connections

1. In RSNetWorx for DeviceNet software, right-click the SmartGuard controller and choose Properties.

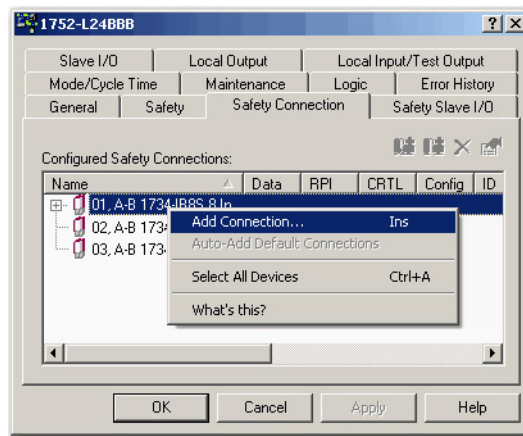


2. Click the Safety Connection tab to see a list of all Safety I/O modules currently in your project.

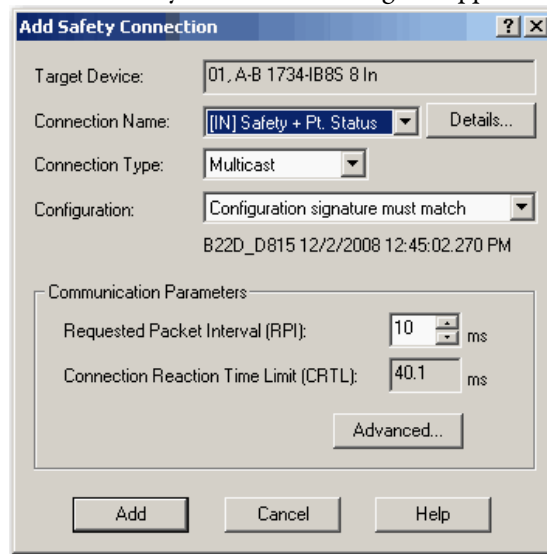




3. Right-click the POINT Guard I/O module and choose Add Connection.



The Add Safety Connection dialog box appears.



You can add individual safety connections for the inputs and outputs. The SmartGuard 600 controller can have up to 32 connections.

- To add a safety connection, from the Connection Name pull-down menu, choose one of these options.

	Choose	Description
1734-IB8S	[IN] Safety	Control of safety inputs
	[IN] Safety + Combined Status <sup>(1)</sup> - Muting	<ul style="list-style-type: none"> <li>Control of safety inputs</li> <li>Status combined into 1 bit for all inputs</li> <li>Muting status is available</li> </ul>
	[IN] Safety + Pt. Status	<ul style="list-style-type: none"> <li>Control of safety inputs</li> <li>Individual status for each input point</li> </ul>
	[IN] Safety + Pt. Status - Muting	<ul style="list-style-type: none"> <li>Control of safety inputs</li> <li>Individual status for each input point</li> <li>Muting status available</li> </ul>
	[IN] Safety + Pt. Status - Muting - Test Output	<ul style="list-style-type: none"> <li>Control of safety inputs</li> <li>Individual status for each input point</li> <li>Muting status available</li> <li>Test output status available</li> </ul>
	[OUT] Test	Control of test outputs
1734-OB8S	[IN] Safety Monitor - Combined Status - Power	<ul style="list-style-type: none"> <li>Monitor safety outputs</li> <li>Status combined into 1 bit for all outputs</li> <li>Power status available</li> </ul>
	[IN] Safety Output Status	Individual status for each output point
	[IN] Safety Output Status + Monitor	<ul style="list-style-type: none"> <li>Individual status for each output point</li> <li>Monitor safety outputs</li> </ul>
	[OUT] Safety	Control of safety outputs
1734-OBV2S	[IN] Safety Monitor - Combined Status - Power	<ul style="list-style-type: none"> <li>Monitor safety outputs</li> <li>Status combined into 1 bit for all outputs</li> <li>Power status available</li> </ul>
	[IN] Safety Output Status	Individual status for each output point
	[IN] Safety Output Status + Monitor	<ul style="list-style-type: none"> <li>Individual status for each output point</li> <li>Monitor safety outputs</li> </ul>
	[OUT] Safety	Control of safety outputs
1734-IE4S <sup>(2)</sup>	[IN] Channel and Combined Alarm Status	Combined channel status and alarm status for each input point
	[IN] Channel Status, Alarm Status	<ul style="list-style-type: none"> <li>Individual status for each input point</li> <li>Combined alarm status for each input point</li> <li>Power status</li> </ul>
	[OUT] Tach Reset	Resets a latched overfrequency condition and enables the module to begin to calculate frequency again.

(1) Most digital input connections use Combined Status.

(2) Other connection options are available via RSNetWorx for DeviceNet software, but their use with a SmartGuard controller is not recommended.

The more status that is read, the larger the packet size.

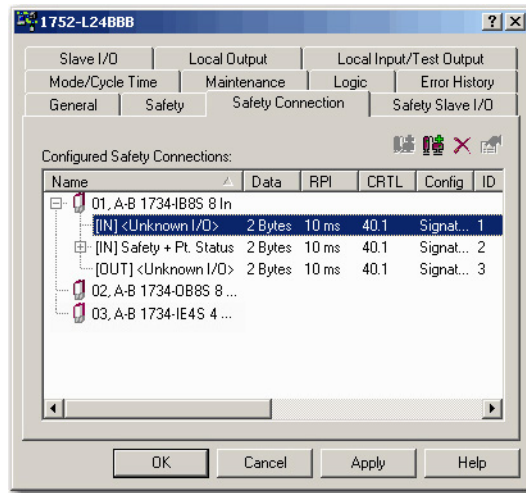
- From the Connection Type pull-down menu, for this example choose Multicast.
- From the Configuration pull-down menu, for this example choose Configuration signature must match.

7. In the Requested Packet Interval (RPI) box, enter 10 ms.
8. In the Connection Reaction Time Limit (CRTL), enter 40.1 ms.
9. Click Add.

This value limits the packet size for normal communication. If detailed status is required when a fault occurs, the data can be read explicitly via MSG instructions.

10. Repeat steps [3...9](#) for each connection, being sure to assign input and output connections.

Notice that the connections for the 1734-IB8S module have 2 bytes. If you had selected individual point status, the input connection would be 5 bytes.

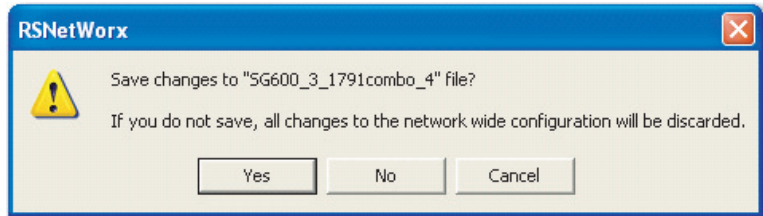


11. Click Apply.

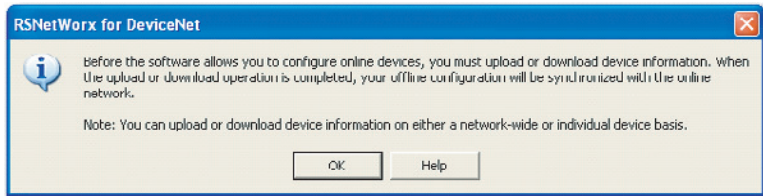
For further details, see the SmartGuard 600 Controllers User Manual, publication [1752-UM001](#), and SmartGuard 600 Controllers Safety Reference Manual, publication [1752-RM001](#).

## Complete the Set Up of the SmartGuard Controller

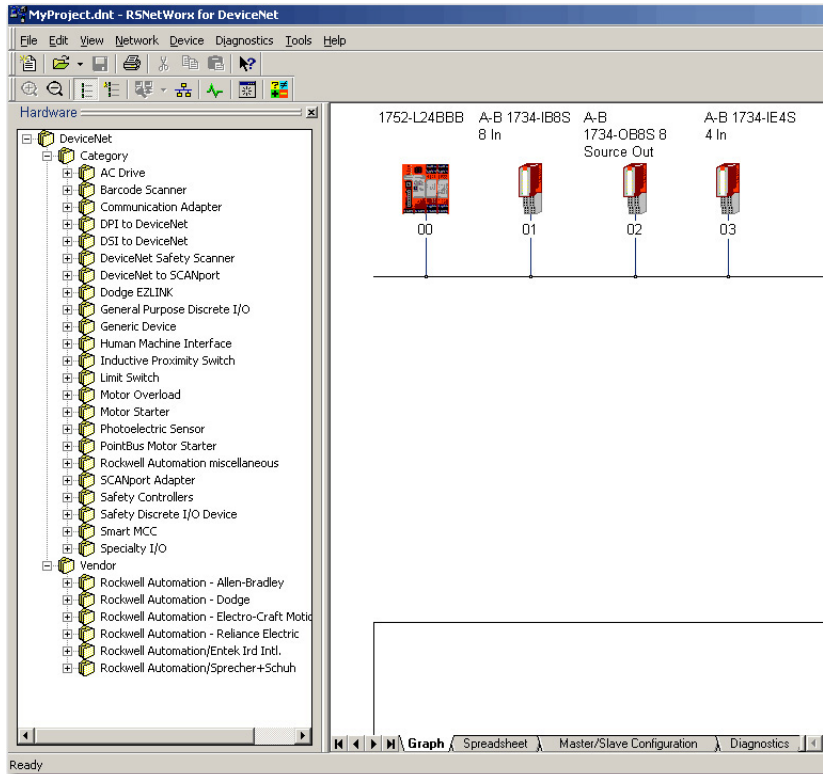
1. From the 1752-L24BBB dialog box, click Apply and then OK to accept the connection.
2. Place RSNetWorx from DeviceNet software back into Online mode.
  - a. If you see this dialog box, click Yes to save changes.



- b. Click OK to upload or download device information.



You see the following nodes after the browse.



## Save and Download Module Configuration

We recommend that after a module is configured you save your work

---

**IMPORTANT** If you have not followed the configuration guidelines in the parameter tables found in [Configure Safety Analog Inputs on page 119](#), the error message “Invalid Configuration Parameter occurred while attempting to configure the safety device” appears in the Error Log during download.

---

If the MS and NS status indicators on the POINT Guard I/O module are not both solid green after download, ownership has the potential to have been lost. The ownership is based on the following:

- POINT Guard I/O module number
- POINT Guard I/O safety network number
- SmartGuard slot number
- SmartGuard safety network number
- Path from SmartGuard controller to POINT Guard I/O module
- Configuration signature

If any of the preceding parameters change, the connection between the SmartGuard controller and the POINT Guard I/O module is lost, and a yellow yield icon appears in the RSNetWorx for DeviceNet tree. For more information, see [Chapter 8](#).

**Notes:**

## Configuring Safety Connections between a GuardLogix Controller and POINT Guard I/O Modules on a DeviceNet Network

Topic	Page
Configure the Module in RSNetWorx for DeviceNet Software	131
Add the POINT Guard I/O Module to the Controller Project	132
Complete the Safety Configuration	136
Download the DeviceNet Network Configuration	138
Verify Your DeviceNet Safety Configuration	139

To use POINT Guard I/O™ modules with a GuardLogix® controller via a DeviceNet network, you must use a 1734-PDN module in place of an adapter. When using a 1734-PDN module, you must use RSNetWorx™ for DeviceNet software to configure the POINT Guard I/O modules. The Generic DeviceNet Safety Module profile in the Logix Designer application to use the module data inside of the safety task.

### Configure the Module in RSNetWorx for DeviceNet Software

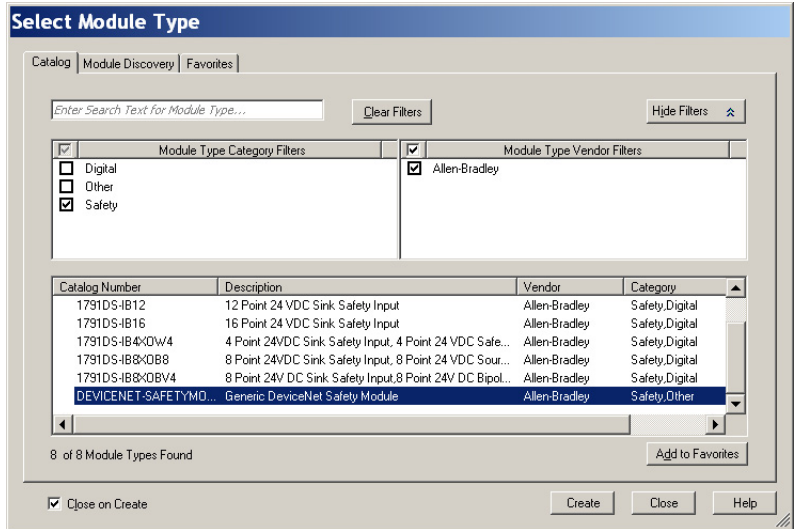
Before you can add the module to the GuardLogix controller project, you must perform a number of tasks in RSNetWorx for DeviceNet software.

1. Set the node address of the module by using the Node Commissioning Tool. See [Set the Node Address on page 110](#).
2. Configure the inputs and outputs of the module. See the following sections:
  - [Configure Digital Safety Inputs and Test Outputs on page 115](#)
  - [Configure Digital Safety Outputs on page 118](#)
  - [Configure Safety Analog Inputs on page 119](#)

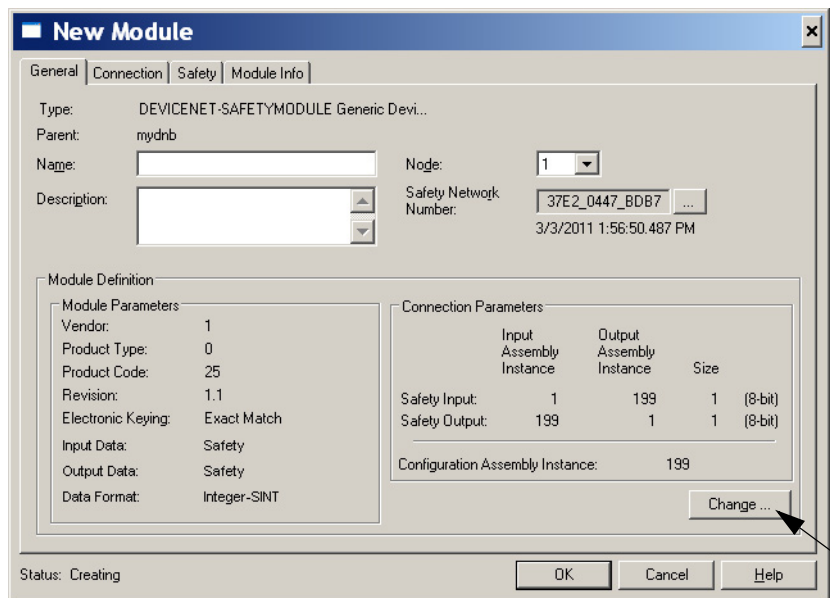
## Add the POINT Guard I/O Module to the Controller Project

Follow these steps to connect to the controller.

1. In the Logix Designer application, right-click the DeviceNet network and choose New Module.
2. In the Select Module Type dialog box, check Safety and Allen-Bradley.
3. Select the Generic DeviceNet Safety Module and click Create.



4. On the New Module dialog box, click Change.

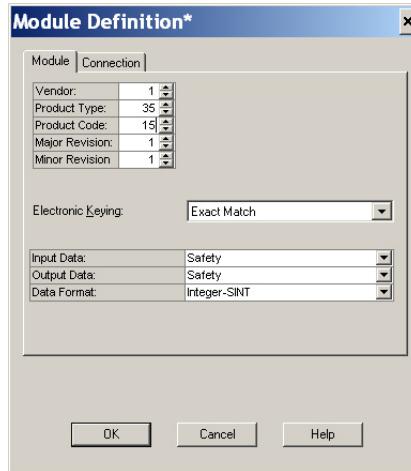




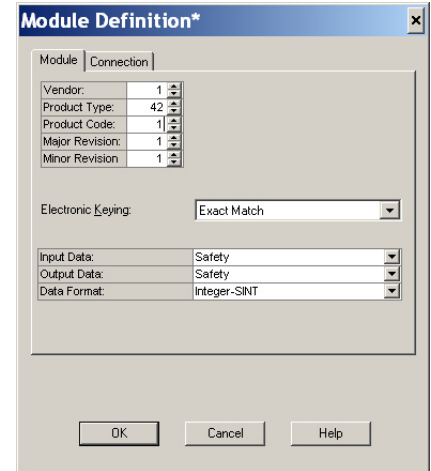
- On the Module Definition dialog box, set these parameters for your module.

Cat. No.	Product Type	Product Code
1734-IB8S	35	15
1734-OB8S	35	16
1734-OBV2S	35	32
1734-IE4S	42	1

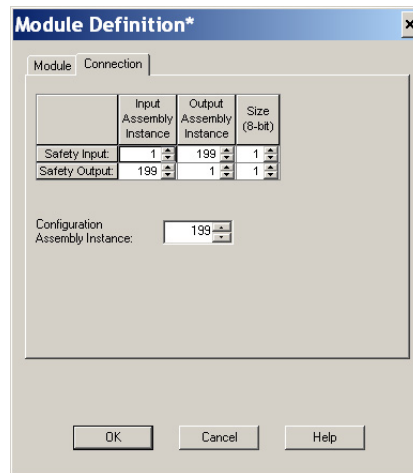
1734-IB8S Module



1734-IE4S Module



- Click the Connection tab.



- Set the Configuration Assembly Instance to 864 for all POINT Guard modules.

8. Determine which assemblies you want to connect to and set the safety input and output assemblies by using the following tables.

**Table 5 - 1734-IB8S Input Assemblies**

Safety Input Connection	Input Assembly Safety Input Number	Input Assembly Safety Output Number	Size
Safety	516 (204 h)	199 (C7h)	1
Safety + Combined Status – Muting	788 (314 h)	199 (C7h)	2
Safety + Pt. Status	548 (224 h)	199 (C7h)	2
Safety + Pt. Status – Muting	820 (334 h)	199 (C7h)	3
Safety + Pt. Status – Muting – Test Output	868 (364 h)	199 (C7h)	4

**Table 6 - 1734-IB8S Output Assemblies**

Safety Output Connection	Output Assembly Safety Input Number	Output Assembly Safety Output Number	Size
Test	199 (C7h)	33 (21 h)	1

**Table 7 - 1734-OB8S Input Assemblies**

Safety Input Connection	Input Assembly Safety Input Number	Input Assembly Safety Output Number	Size
Safety Output Status	580 (244 h)	199 (C7h)	1
Output Status + Monitor	1028 (404 h)	199 (C7h)	2
Safety Monitor + Combined Status + Power	1044 (414 h)	199 (C7h)	2

**Table 8 - 1734-OB8S Output Assemblies**

Safety Output Connection	Output Assembly Safety Input Number	Output Assembly Safety Output Number	Size
Safety	199 (C7h)	564 (234 h)	1

**Table 9 - 1734-OBV2S Input Assemblies**

Safety Input Connection	Input Assembly Safety Input Number	Input Assembly Safety Output Number	Size
Safety Output Status	579 (243 h)	199 (C7h)	1
Output Status + Monitor	1027 (403 h)	199 (C7h)	1
Safety Monitor + Combined Status + Power	1043 (413 h)	199 (C7h)	2

**Table 10 - 1734-OBV2S Output Assemblies**

Safety Output Connection	Output Assembly Safety Input Number	Output Assembly Safety Output Number	Size
Safety	199 (C7h)	563 (233 h)	1

**Table 11 - 1734-IE4S Input Assemblies**

Safety Input Connection	Input Assembly Safety Input Number	Input Assembly Safety Output Number	Size
Safety + Status	402 (192 h)	199 (C7h)	9
Safety + Status + Alarms	786 (312 h)	199 (C7h)	13
Safety + Status + Process Status + Fault Reason + Alarms	802 (322 h)	199 (C7h)	18

**Table 12 - 1734-IE4S Output Assemblies**

Safety Output Connection	Output Assembly Safety Input Number	Output Assembly Safety Output Number	Size
Safety Tachometer	199 (C7h)	770 (302 h)	1

Individual members of each assembly are listed in [Appendix F](#).

---

**IMPORTANT** If you are using the 1734-IE4S module with a GuardLogix system, use the application program to evaluate any dual channel requirements and determine any process alarms.

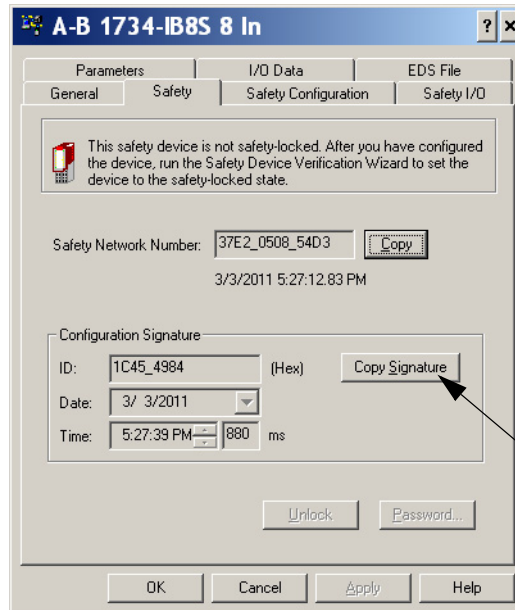
---

9. Click OK.
10. On the Safety Tab, uncheck the Configuration Signature checkbox.
11. Click OK and OK again to add the module to the I/O Configuration tree.

## Complete the Safety Configuration

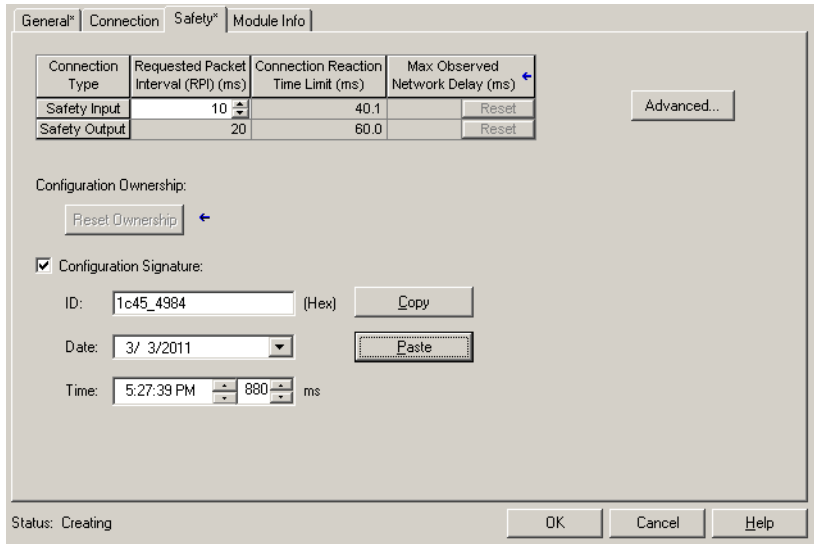
Follow these steps to copy the configuration signature and safety network number from RSNetWorx for DeviceNet software to the generic profile you configure in the Logix Designer application.

1. In RSNetWorx for DeviceNet software, double-click the module.
2. On the Safety tab, click Copy Signature.

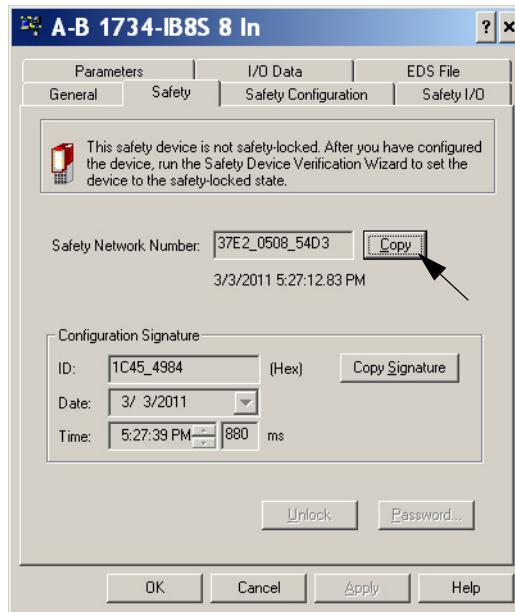


3. In the Logix Designer application, right-click the DEVICENET-SAFETYMODULE and choose Properties.

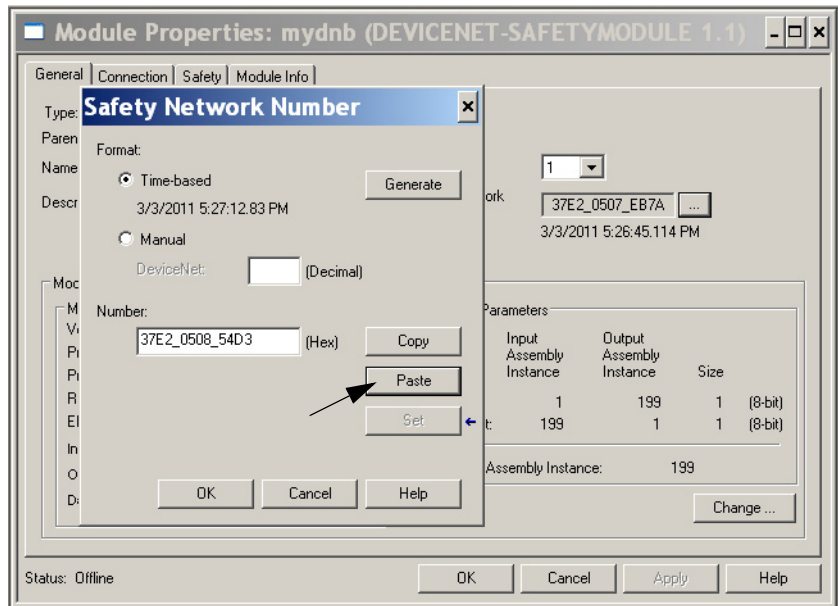
4. On the Safety tab, check the Configuration Signature checkbox.
5. Click Paste.



6. In RSNetWorx for DeviceNet software, click Copy to copy the safety network number.



7. On the General tab in the Logix Designer application, click  next to the safety network number field.
8. Click Paste.




## Download the DeviceNet Network Configuration

Before you download, you must go online to the DeviceNet network by using RSNetWorx for DeviceNet software. Your computer and the devices you wish to communicate with must be connected to the DeviceNet network.

When you go online to a DeviceNet network, RSNetWorx for DeviceNet software browses the network one time and shows you the devices on the network. If you go online, this action does not upload (read) or download (change) the parameters of any of the devices.

To download the DeviceNet network configuration, follow these steps.

1. Go online by clicking the online  icon.
2. Browse to the DeviceNet network and click OK at the prompt.
3. Download your configuration to the network by right-clicking the device and then choose Download to Device.
4. To download, click yes.

## Verify Your DeviceNet Safety Configuration

---

**IMPORTANT** Before running the Safety Device Verification Wizard, you must browse and upload your network and test the safety devices and all of their safety functions on your network to verify that they are operating properly. You must fully test your application before safety-locking your devices.

---

The Safety Device Verification Wizard, which is accessed from RSNetWorx for DeviceNet software, guides you through the verification of the configuration of your safety devices and provides the means for safety-locking those devices. The verification process includes upload and comparison of the configuration that is stored in the device and the configuration that is stored in the RSNetWorx for DeviceNet software configuration file. The configuration is displayed in a report to facilitate visual verification and record keeping.

---

**IMPORTANT** Some devices on your network can not support verification by the Safety Device Verification Wizard. To determine the method that is required for verifying these devices, consult the user documentation.

---






To run the Safety Device Verification Wizard, follow these steps.

1. Choose Network > Safety Device Verification Wizard.
2. On the Welcome dialog box, click Next.

## Determine If Devices Can Be Verified

When the Safety Device Verification Wizard browses the network, it checks the safety status of the devices on the network to determine if the devices can be verified.

If any devices are in a state that prevents the wizard from continuing the verification process, the ‘unable to verify that the listed devices dialog box’ appears. The box lists those devices and their status, including a device icon, that is overlaid with a status icon.

Message	Icon Overlay	Description
Missing		The device is part of the network configuration, but was not found during the browse operation.
Mismatch		The device identity in the network configuration does not match the identity of the online device.
Unknown		The device is in the configuration, but has not been detected on the network yet.
Safety Network Number Error		The safety network number (SNN) in the device is either invalid or does not match the SNN for the device in the RSNetWorx for DeviceNet configuration file.
Signature Mismatch	None	The configuration signature in the device does not match the configuration signature in the RSNetWorx for DeviceNet configuration file.
Safety Locked		The device is already locked.

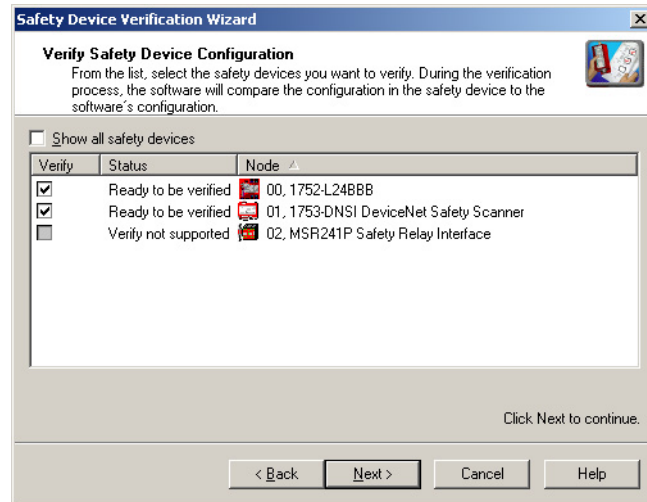
To return to RSNetWorx for DeviceNet software so that you can correct the status of the indicated devices, close the Safety Device Verification Wizard by clicking Cancel.

To skip the devices that are listed and continue the verification process for other safety devices on the network, click Next.



## Select Devices to Verify

Choose which devices to verify by using the checkboxes in the Verify column of the Verify Safety Device Configuration dialog box. You can select only the devices whose status is Ready to be verified.



If the Show all safety devices checkbox is checked, the dialog box lists all safety devices on the network and shows their status. If it is unchecked, which is the default, only devices with the following status are shown:

- Verify FAILED

The upload and compare operation indicated that the configuration in the device does not match the configuration in the RSNetWorx for DeviceNet configuration file.

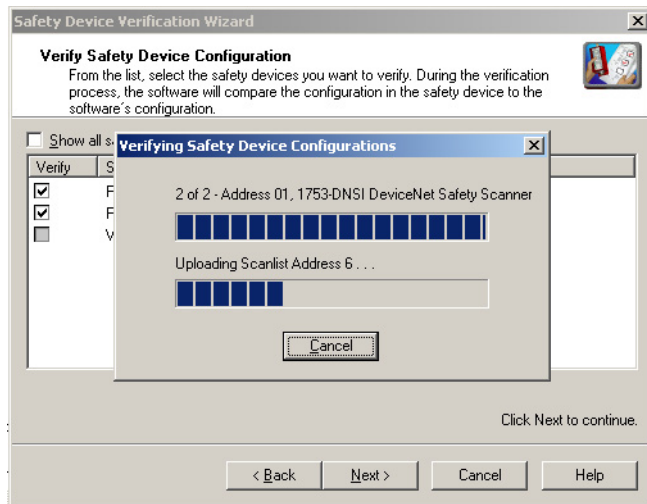
- Ready to be verified

The device is not safety-locked and can be selected for verification.

- Verify not supported

The device is not safety-locked, but the device does not support verification via the Safety Device Verification Wizard. Consult your user documentation for information on how to verify this device. Once the device has been verified, the wizard can safety-lock it.

To begin the upload and compare process, click Next.



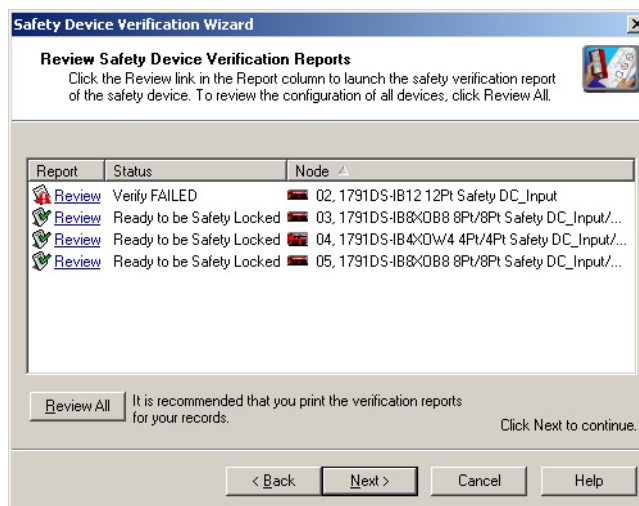
**TIP**

If you click Next without selecting a device to verify, the wizard checks whether any devices were verified or are ready to be locked in this execution of the wizard.

If	Then the wizard displays
Devices were verified	The Review dialog box that lists those devices.
Devices are ready to be safety-locked	The Lock dialog box that lists those devices.
No devices were verified	The Finish dialog box.
No devices are ready to be safety-locked	The Finish dialog box.

## Review the Safety Device Verification Reports

The Review page displays safety devices with status of either Verify FAILED or Ready to be Safety Locked.



1. Click Review in the Report column to launch the HTML report of the device in your default browser.
2. To generate an HTML verification report for all devices listed, click Review All.

**TIP** If the status of a device is Verify FAILED, more information is provided in the verification failure report.

3. Review and print the verification reports for your records.

---

**IMPORTANT** You must review the device configurations and record the configuration signatures before operating a safety application.

---

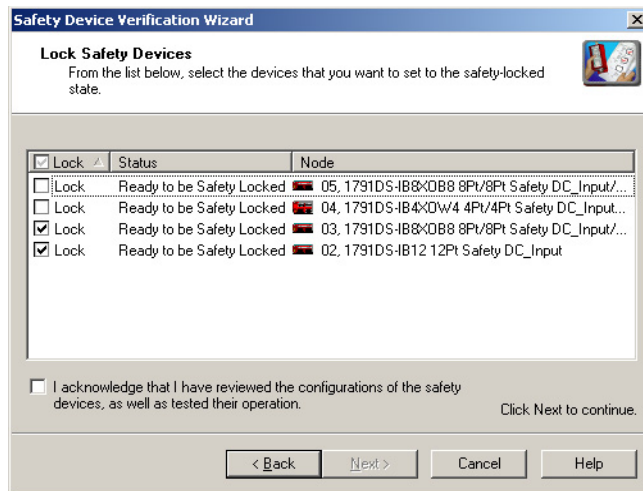
## Lock Safety Devices

---

**IMPORTANT** Before you lock your safety device configurations, you must perform all verification steps that are required for your application.

---

1. Choose which devices to safety-lock by checking the checkbox in the Lock column for each device that is ready to be safety-locked.



2. Check the acknowledgment checkbox so the locking process can continue.
3. Click Next.

The wizard performs a final comparison of the configuration signature in each safety device to its configuration signature in RSNetWorx for DeviceNet software before locking the device.

4. View the Safety Device Verification Wizard Summary

Before closing, the wizard displays a summary of all safety devices that were safety-locked. It also displays the number of safety devices that still must be safety-locked, and lets you display the verified and safety-locked state of all safety devices on the network.

5. To close the wizard, click Finish.

## Replacing POINT Guard I/O Modules

Topic	Page
The Safety Network Number	145
Manually Setting the Safety Network Number	146
Resetting a Module to Out-of-box Condition	147
Replace a Module in a GuardLogix System on an EtherNet/IP Network	150
Replace a Module When Using a SmartGuard or GuardLogix Controller on a DeviceNet Network	157

This chapter provides information on replacing POINT Guard I/O™ modules when they are connected to GuardLogix® or SmartGuard™ controllers. For more information on these controllers, refer to the controller publications listed in the [Additional Resources on page 10](#).

A major difference in functionality between the GuardLogix and SmartGuard safety controllers affects the replacement of safety I/O modules. GuardLogix controllers retain I/O module configuration onboard and are able to download the configuration to the replacement module. SmartGuard controllers do not retain I/O module configuration, so you must use RSNetWorx™ for DeviceNet software to download the configuration to the replacement module.

### The Safety Network Number

Replacing a safety I/O module that sits on a CIP safety network is more complicated than replacing standard devices because of the safety network number (SNN). The module number and SNN make up the DeviceID of the safety module. Safety devices require this more complex identifier to make sure that duplicate module numbers do not compromise communication between the correct safety devices.

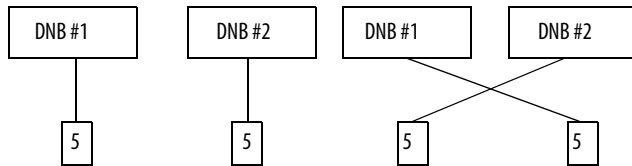
The following, simplified example shows Guard I/O™ modules on a DeviceNet network. Your products can differ, but the function is the same.

**EXAMPLE**

The DeviceNet network supports 64 node numbers, so if you have 100 devices on multiple DeviceNet networks, there are at least 36 duplicate node numbers being used. Even though the duplicate nodes are on separate DeviceNet networks, it must still be considered in a safety system.

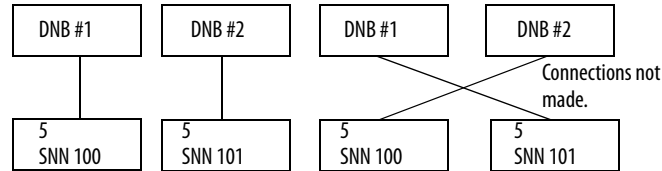
In this example, the DNB scanner #1 is connected to node 5. The DNB scanner #2 is connected to another node 5. If the cables get inadvertently crossed, the scanners can be communicating with the incorrect node 5.

**Crossed Cables**



This crossed-cable scenario is unacceptable for a safety system. The SNN provides unique identification of every safety device. In this next example, all devices that are connected to DNB scanner #1 have an SNN of 100. All devices that are connected to DNB scanner #2 have an SNN of 101. If the cables get inadvertently crossed, the node connected to DNB scanner #1 changes from 100/5 to 101/5. The node that is connected to DNB scanner #2 changes from 101/5 to 100/5. Therefore, the safety connections are not made if the cables get crossed.

**Connections Not Made**

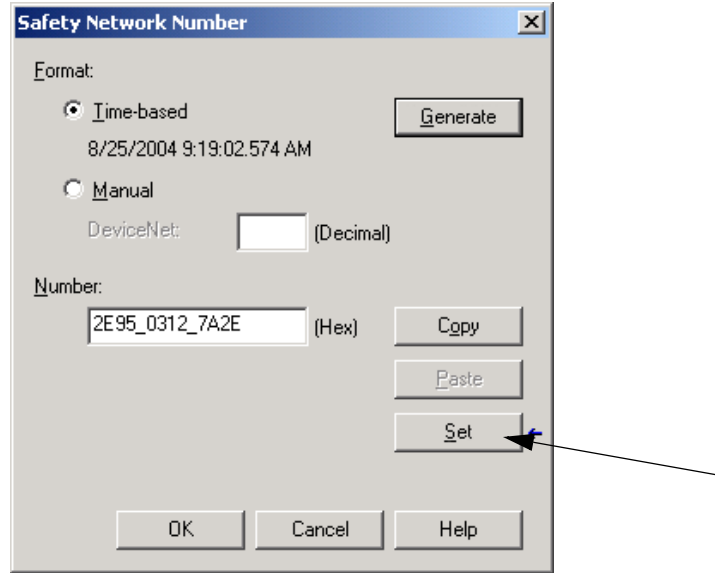


**Manually Setting the Safety Network Number**

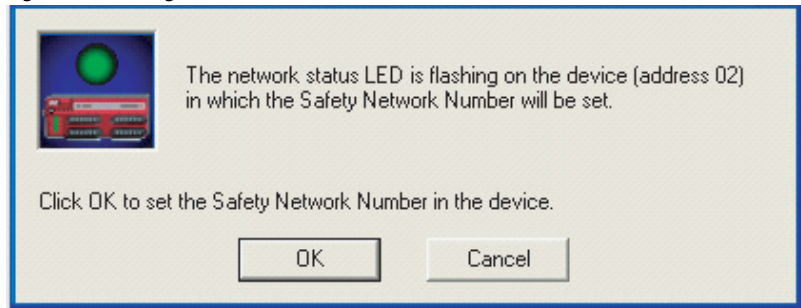
The previous examples showed how the SNN is used to provide safety-connection integrity after the system is operational. But the SNN is also used to provide integrity on the initial download to the POINT Guard I/O module.

If a safety signature exists, then the POINT Guard I/O module must have a proper SNN/node number identification that matches the module within the safety controller project, before it can receive its configuration. And to keep integrity, the SNN setting of the module is required to be a manual action. This manual action is to use the 'set' function on an out-of-box POINT Guard I/O module.

**Figure 49 - Setting the SNN with a GuardLogix Controller**



**Figure 50 - Setting the SNN with a SmartGuard Controller**



## Resetting a Module to Out-of-box Condition

If a POINT Guard I/O module was used previously, clear the existing configuration before installing it on a safety network.

When using POINT Guard I/O with a	See
GuardLogix controller on an EtherNet/IP network	<a href="#">By Using the Logix Designer Application on page 148</a>
GuardLogix controller with 1734-PDN module on a DeviceNet network	<a href="#">By Using RSNetWorx for DeviceNet Software on page 149</a>
SmartGuard controller on a DeviceNet network	

## By Using the Logix Designer Application

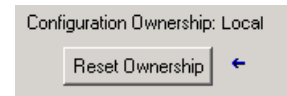
When the Logix Designer application is online, the Safety tab of the Module Properties dialog box displays the current configuration ownership. When the opened project owns the configuration, Local is displayed. When a second device owns the configuration, Remote is displayed, along with the safety network number (SNN), and node address or slot number of the configuration owner. Communication error is displayed if the module read fails.

If the connection is Local, you must inhibit the module connection before you reset ownership. To inhibit the module:

1. Right-click the module and choose Properties.
2. Click the Connection tab.
3. Check the inhibit module checkbox.
4. Click Apply and then OK.

Follow these steps to reset the module to its out-of-box configuration when online.

1. Right-click the module and choose Properties.
2. Click the Safety tab.
3. Click Reset Ownership.

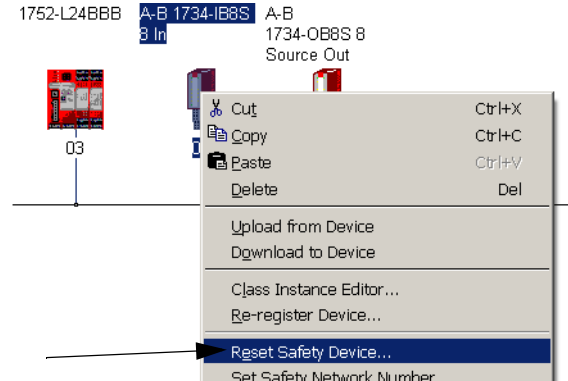




## By Using RSNetWorx for DeviceNet Software

Follow these steps to reset the module to an out-of-box condition.

1. Right-click the module and choose Reset Safety Device.



2. Check all options.



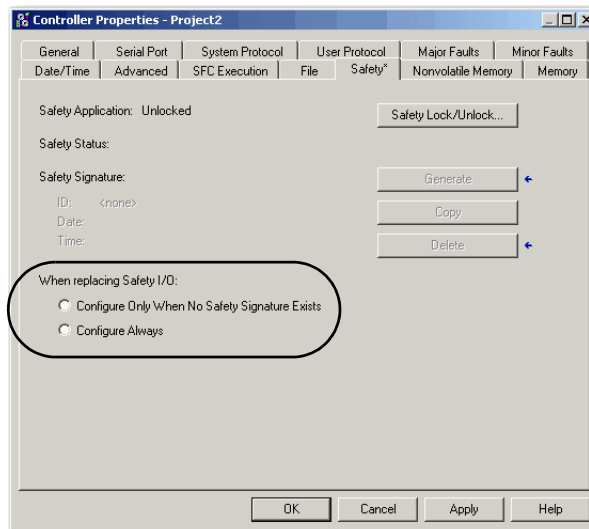
3. Click Reset.

## Replace a Module in a GuardLogix System on an EtherNet/IP Network

If you are relying on a portion of the CIP Safety system to maintain SIL 3 behavior during module replacement and functional testing, you must not use the Configure Always feature. Go to [Replacement with 'Configure Only When No Safety Signature Exists' Enabled on page 150](#).

If you are not relying on the entire routable CIP Safety control system to maintain SIL 3/PLe during the replacement and functional testing of a module, you can use the Configure Always feature. Go to [Replacement with 'Configure Always' Enabled on page 155](#).

Module replacement is configured on the Safety tab of the GuardLogix controller.



### Replacement with 'Configure Only When No Safety Signature Exists' Enabled


When a module is replaced, the configuration is downloaded from the safety controller if the DeviceID of the new module matches the original. The DeviceID is a combination of the node/IP address and the safety network number (SNN) and is updated whenever the SNN is set.

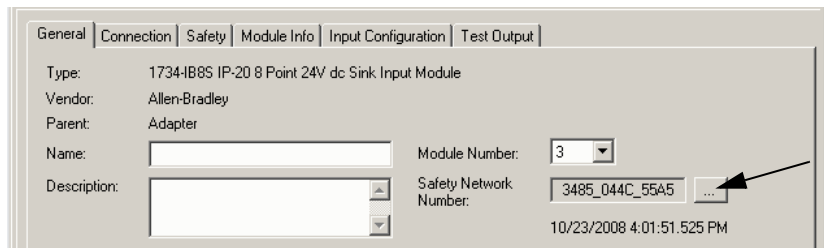
If the project is configured as 'Configure Only When No Safety Signature Exists', follow the appropriate instructions in [Table 13](#) to replace a POINT Guard I/O module that is based on your scenario. Once you have completed the steps in the scenario correctly, the DeviceID matches the original. This match enables the safety controller to download the proper module configuration, and re-establish the safety connection.

**Table 13 - Replacing a Module**

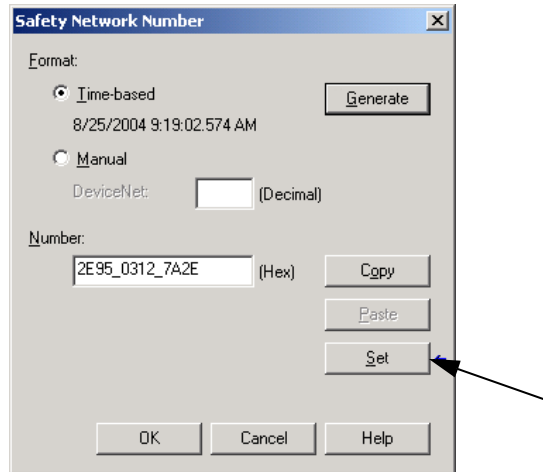
GuardLogix Safety Signature Exists	Replacement Module Condition	Action Required
No	No SNN (Out-of-box)	None. The module is ready for use.
Yes or No	Same SNN as original safety task configuration	None. The module is ready for use.
Yes	No SNN (Out-of-box)	See <a href="#">Scenario 1 - Replacement Module Is Out-of-box and Safety Signature Exists on page 151.</a>
Yes	Different SNN from original safety task configuration	See <a href="#">Scenario 2 - Replacement Module SNN Is Different from Original and Safety Signature Exists on page 152.</a>
No	Different SNN from original safety task configuration	See <a href="#">Scenario 3 - Replacement Module SNN Is Different from Original and No Safety Signature Exists on page 154.</a>

*Scenario 1 - Replacement Module Is Out-of-box and Safety Signature Exists*

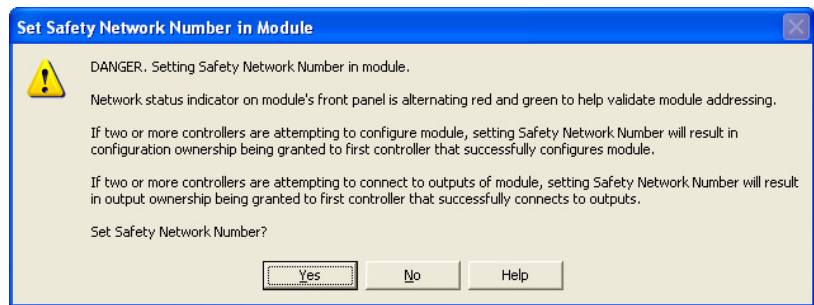
1. Remove the old I/O module and install the new module.
2. Right-click the replacement POINT Guard I/O module and choose Properties.
3. To open the Safety Network Number dialog box, click  to the right of the safety network number.



4. Click Set.



5. Verify that the Network Status (NS) status indicator is alternating red/green on the correct module before clicking yes on the confirmation dialog box to set the SNN and accept the replacement module.

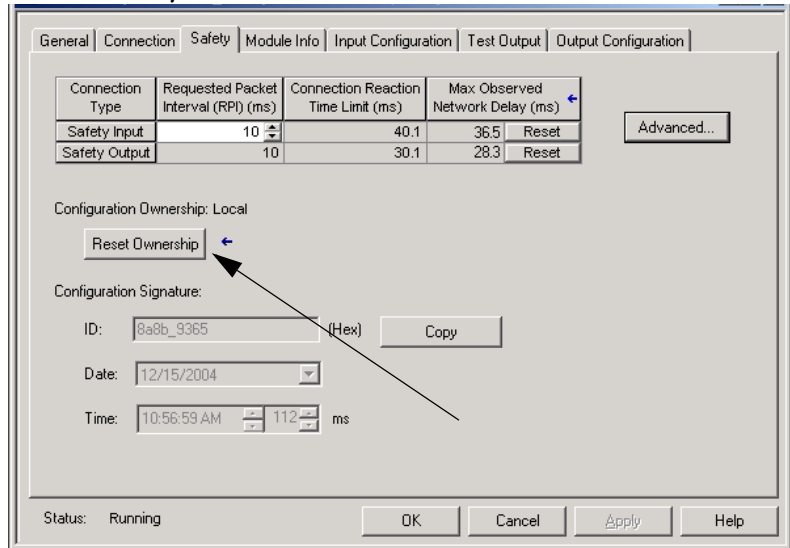


6. Follow your company-prescribed procedures to functionally test the replaced I/O module and system and to authorize the system for use.

*Scenario 2 - Replacement Module SNN Is Different from Original and Safety Signature Exists*

1. Remove the old I/O module and install the new module.
2. Right-click your POINT Guard I/O module and choose Properties.

3. Click the Safety tab.

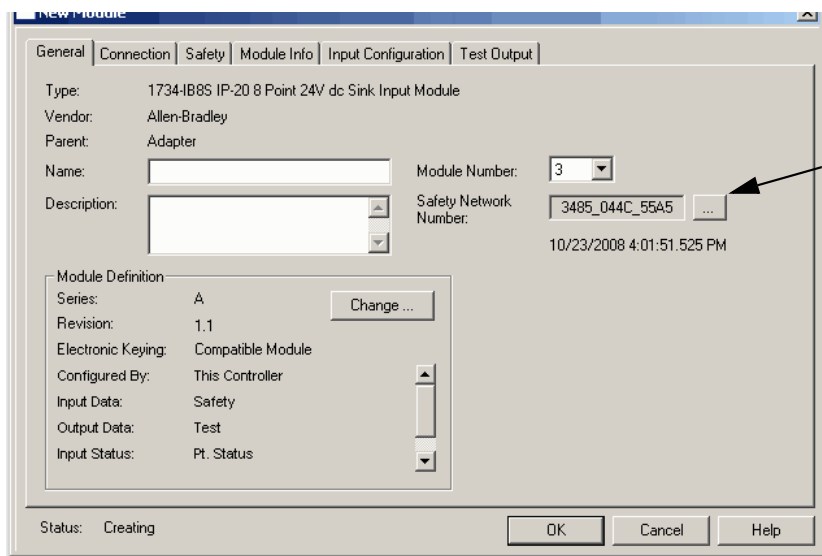


4. Click Reset Ownership.

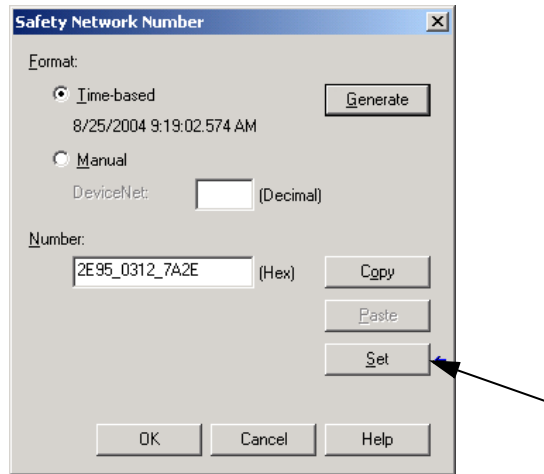
5. Click OK.

6. Right-click your module and choose Properties.

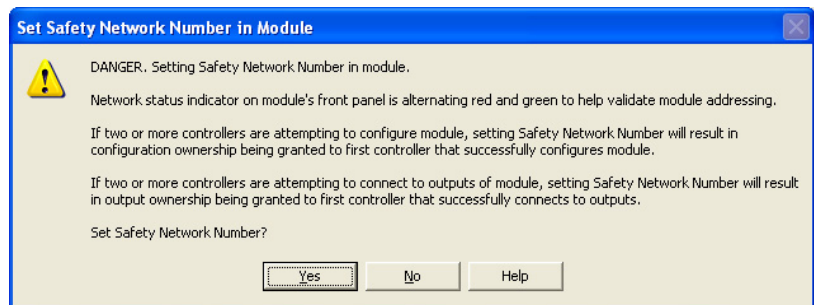
7. To open the Safety Network Number dialog box, click **...** to the right of the safety network number.



8. Click Set.



9. Verify that the Network Status (NS) status indicator is alternating red/green on the correct module before clicking yes on the confirmation dialog box to set the SNN and accept the replacement module.



10. Follow your company-prescribed procedures to test the replaced I/O module and system and to authorize the system for use.

*Scenario 3 - Replacement Module SNN Is Different from Original and No Safety Signature Exists*

1. Remove the old I/O module and install the new module.
2. Right-click your POINT Guard I/O module and choose Properties.

## 3. Click the Safety tab.

Connection Type	Requested Packet Interval (RPI) (ms)	Connection Reaction Time Limit (ms)	Max Observed Network Delay (ms)
Safety Input	10	40.1	36.5
Safety Output	10	30.1	28.3

Configuration Ownership: Local

Reset Ownership

Configuration Signature:

ID: 8a8b\_9365 (Hex) Copy

Date: 12/15/2004

Time: 10:56:59 AM 112 ms

Status: Running

OK Cancel Apply Help

## 4. Click Reset Ownership.

## 5. Click OK.

## 6. Follow your company-prescribed procedures to test the replaced I/O module and system and to authorize the system for use.

## Replacement with 'Configure Always' Enabled



**ATTENTION:** Enable the 'Configure Always' feature only if the entire CIP Safety Control System is not being relied on to maintain SIL 3 behavior during the replacement and functional testing of a module.

Do not place modules that are in the out-of-box condition on a CIP Safety network when the Configure Always feature is enabled, except while following this replacement procedure.

When the 'Configure Always' feature is enabled, the controller automatically checks for and connects to a replacement module that meets all the following requirements:

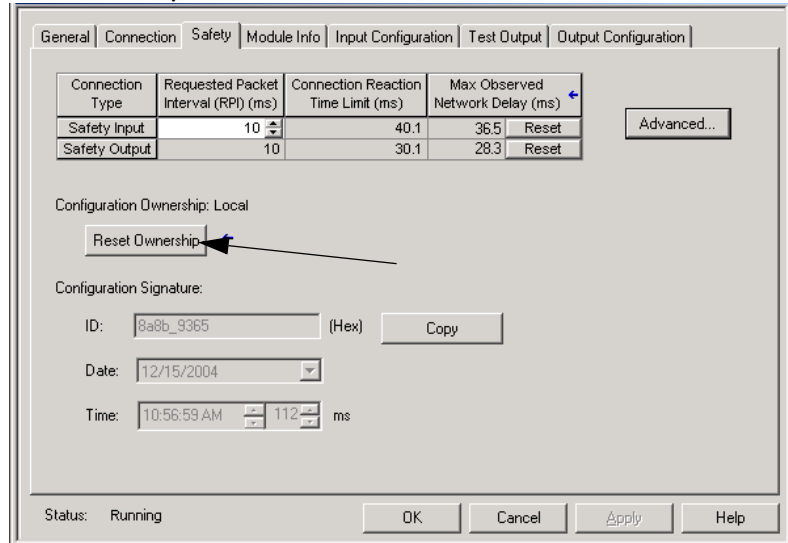
- The controller has configuration data for a compatible module at that network address.
- The module is in out-of-box condition or has an SNN that matches the configuration.

If the project is configured for 'Configure Always', follow the appropriate steps to replace a POINT Guard I/O module.

1. Remove the old I/O module and install the new module.

If	Then
the module is in out-of-box condition	go to step 6. No action is needed for the GuardLogix controller to take ownership of the module.
an SNN mismatch error occurs	go to the next step to reset the module to out-of-box condition.

2. Right-click your POINT Guard I/O module and choose Properties.
3. Click the Safety tab.



4. Click Reset Ownership.
5. Click OK.
6. Follow your company-prescribed procedures to functionally test the replaced I/O module and system and to authorize the system for use.

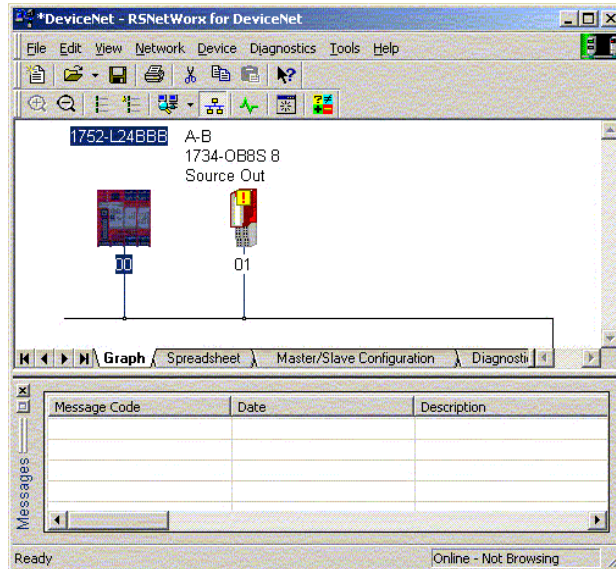


## Replace a Module When Using a SmartGuard or GuardLogix Controller on a DeviceNet Network

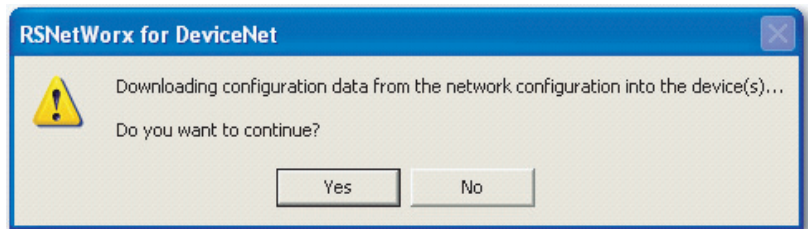
To replace an I/O module when the module and the controller are on a DeviceNet network, follow these steps.

1. Replace the module and match the node number of the original module.
2. In RSNetWorx for DeviceNet software, open your project.

If the replacement module is out-of-box or has an SNN that does not match the original module, the module appears with an exclamation mark.



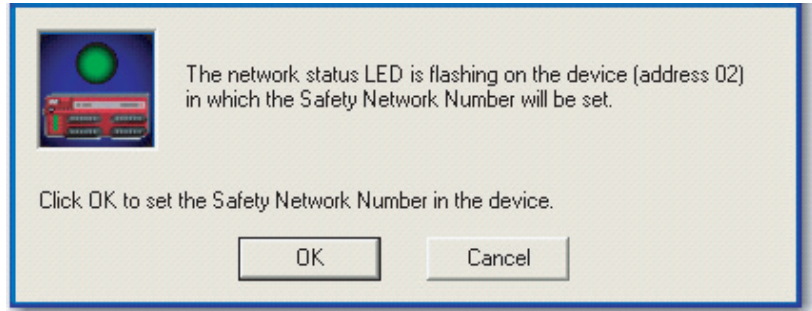
3. Right-click the module and choose Download to Device.



4. Click Yes to confirm.
5. To set the SNN on the replacement module, click Download on the Safety Network Number Mismatch dialog box.



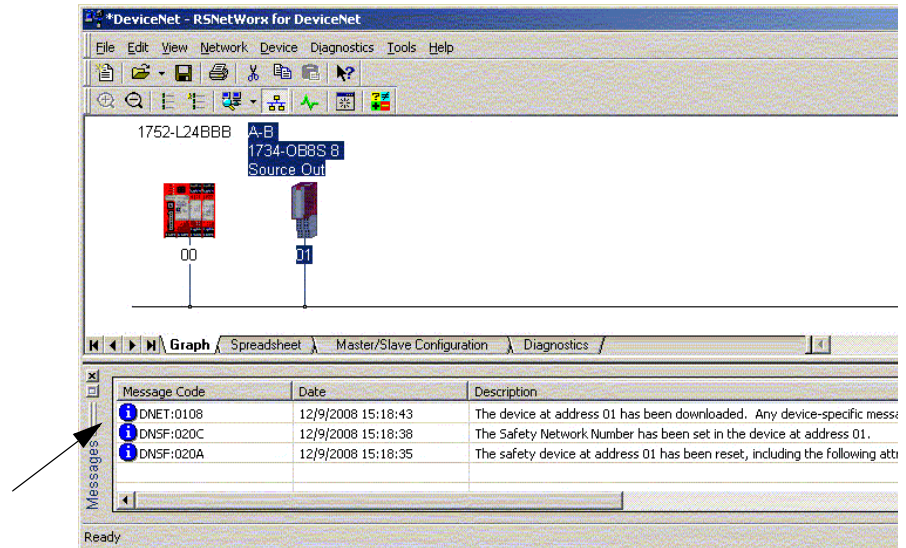
- Verify that the (NS) Network status indicator is flashing on the correct module and click OK to set the SNN on that device.



RSNetWorx for DeviceNet software confirms that the SNN has been set.



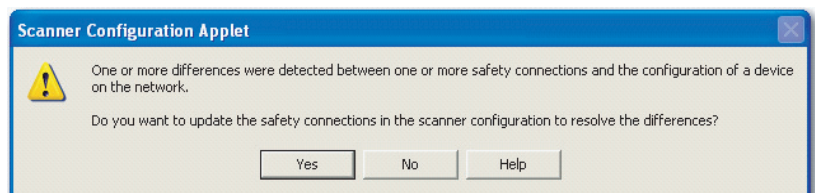
Once the download successfully completes, the main project view displays this message: 'The device at address xx has been downloaded. Any device-specific messages that are related to the download operation are displayed separately.'



If the configuration is correct based on the original DNT file, the SNN and configuration signature now match that of the original. If you are already connected to the controller, a connection is made. The controller does not need to be taken out of Run mode to download to the replacement module.

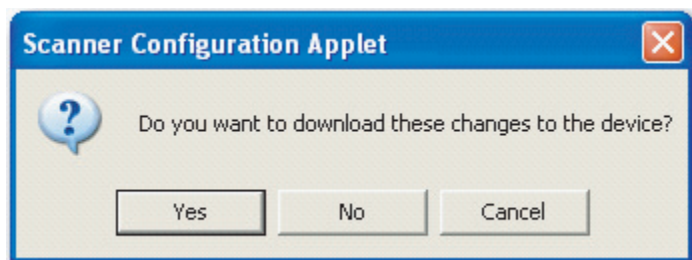
If you download this configuration to a temporary setup, place the module on the network and it automatically connects to the controller.

If the configuration downloaded to the module was not from the original DNT file, the configuration signature does not match the original. Even if you recreate the same parameters in a new DNT file, the time and date portions of the signature are different so the connection to the controller is not made. If this situation occurs, click the Safety Connection tab for the controller that prompted you that the configuration signature is different and provides you with the option to match the new configuration signature. However, you must first revalidate the safety system because it is not using the original DNT file.



7. Click Yes.

This selection takes the controller out of Run mode and prompts you to download the changes.



8. Click Yes to download the new connection configuration to the SmartGuard controller.

After the download is complete, place the controller back in Run mode and the connection to the replacement module is established.

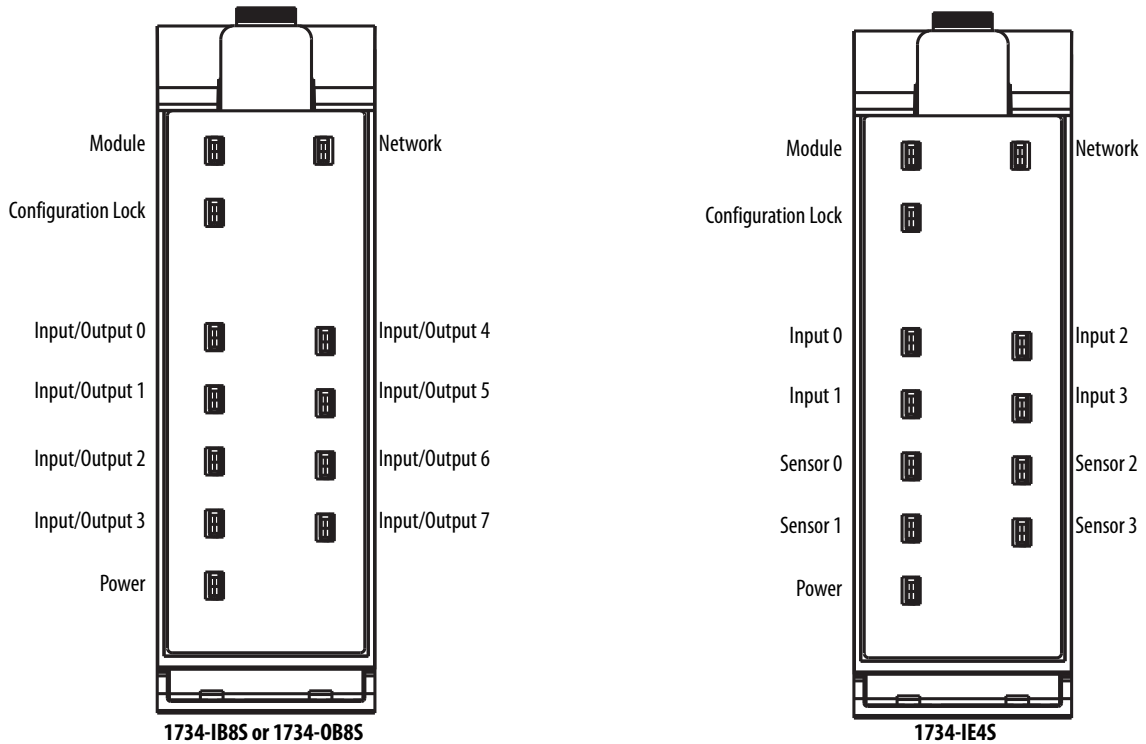
9. Follow your company-prescribed procedures to functionally test the replaced I/O module and system and to authorize the system for use.

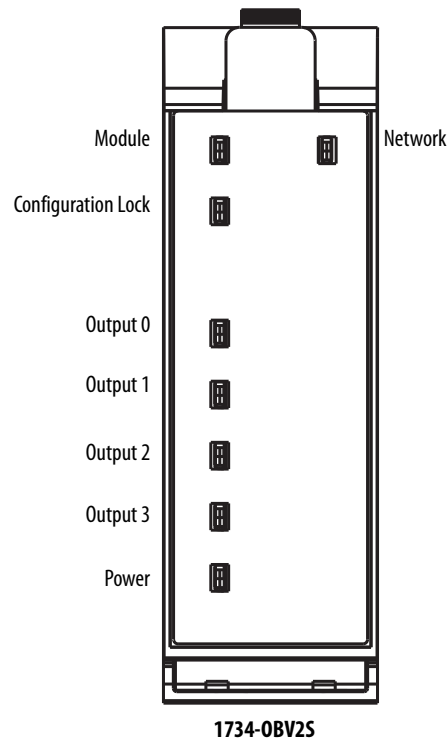
**Notes:**

## Indicators

Topic	Page
Module	162
Network Status	163
Configuration Lock	163
Power	163
1734-IE4S Sensor Power	163
1734-IE4S Safety Analog Input Status	164
1734-IB8S Safety Input Status	164
1734-OB8S Safety Output Status	165

**Figure 51 - Indicators Placement**





## Module

Indicator		Description	Recommended Action
MS	Off	No power is applied to the module.	Apply power to this connector.
	Solid green	The module is operating normally.	None.
	Solid red	The module detected an unrecoverable fault.	Cycle power to the module. If problem persists, replace the module.
	Flashing green	Device is in the Idle or Standby state.	Configure the module and establish connection.
	Flashing red	The module has detected a recoverable fault.	Cycle power to the module or reset the module.
		User-initiated firmware update is in progress.	Wait for firmware update to complete.
	Flashing red and green	Module is not configured.	Reconfigure the module. For additional information, inspect Network status indicator.
The module is performing its power-cycle diagnostic tests.		Wait for the module to complete its power-cycle diagnostics.	

## Network Status

Indicator		Description	Recommended Action
NS	Off	The module is not online with the network or there is no power.	Verify that your network is working properly.
	Flashing green	Module online with no connections in established state.	Verify your network and module configuration.
		The module identified the communication rate of the network but no connections are established.	
	Solid green	Module online with connections in established state. The module is operating normally.	None.
	Flashing red	One or more I/O connections are in timed-out state.	Verify your network and module configuration.
		A user-initiated firmware update is in progress.	Wait for firmware update to complete.
Solid red	Critical link failure. The module detected an error that prevents it from communicating on the network, such as a duplicate node address.	Cycle power to the module. Check node addressing.	

## Configuration Lock

Indicator		Description	Recommended Action
LK <sup>(1)</sup>	Off	No configuration or configured by a GuardLogix® originator.	Validate configuration by a network configuration tool, such as RSNetWorx™ software.
		Invalid configuration data.	
	Solid yellow	Locked.	None.
		Valid configuration, locked by a network configuration tool, such as RSNetWorx software.	
	Flashing yellow	Not locked.	None.
		Valid configuration by a network configuration tool, such as RSNetWorx software.	

(1) Not applicable when used with GuardLogix controllers.

## Power

Indicator		Description	Recommended Action
PWR	Off	No field power applied (all modules) or severe 24VDC power over voltage condition (1734-OBV2S only)	Apply field power that is within specification.
	Green	Normal condition, field power supplied and within specification.	None.
	Yellow	Field power out of specification.	Field power supplied is outside specification (all modules) or the module is configured to use sensor power, and either the sensor is drawing too much current (short in the wiring or sensor), or the sensor is not drawing any current (broken wire or sensor) (1734-IE4S only). Check your connectors, wiring, and voltages.

## 1734-IE4S Sensor Power

Indicator		Description	Recommended Action
S0...S3	Off	Sensor power is not used.	None.
	Green	Sensor power is used.	None.
	Red	Over-current or under-current sensor power fault.	Check connectors, wiring, and power supply.

## 1734-IE4S Safety Analog Input Status

Indicator		Description	Recommended Action
0...3 <sup>(1)</sup>	Off	Safety analog input is not used or the module is being configured.	Reconfigure the channel, if desired.
	Yellow	Safety analog input is configured for use and no faults exist.	None.
	Red	A fault has been detected in the analog input signal path.	Check the fault code in the module that uses one of the data assemblies that contains the Fault Reason. See <a href="#">Appendix B</a> for details. Check configuration, field wiring, and devices. If no problem found, replace module.
	Flashing red	A fault has been detected in the partner input signal path of a dual-input configuration.	Check the field wiring and verify your configuration for the partner circuit. If no problem found, replace module.

(1) Indicator behavior in Tachometer mode facilitates machine setup and troubleshooting. When the tachometer signal is below the configured OFF threshold, the indicator is off. When the tachometer signal is above the ON threshold, the indicator is yellow. Status indicator behavior during normal operation is dependent upon the module update rate and is not intended to indicate the actual tachometer input. When the input rate is above 30 Hz, the status indicator is solid yellow. When the input rate is below 30 Hz, the status indicator is flashing yellow as the signal turns on and off.

## 1734-IB8S Safety Input Status

Indicator		Description	Recommended Action
0...7	Off	Safety input is off, or module is being configured.	Turn on the safety input or reconfigure the channel, if desired.
	Yellow	Safety input is on.	None.
	Red	A fault in the external wiring or input circuit has been detected.	Check configuration, field wiring, and devices. If no problem found, replace module.
	Flashing red	A fault in the partner input circuit of a dual-input configuration has been detected.	Check the field wiring and verify your configuration for the partner circuit. If no problem found, replace module.



## 1734-OB8S Safety Output Status

Indicator		Description	Recommended Action
0...7	Off	Safety output is off, or module is being configured.	Turn on the safety output or reconfigure the channel, if desired.
	Yellow	Safety output is on.	None.
	Red	A fault in the output circuit has been detected.	Check the circuit wiring and end device. If no problem found, replace module.
		The tag values in a dual output configuration do not have the same value.	Make sure that logic is driving tag values to the same state (off or on).
Flashing red	A fault in the partner output circuit of a dual-output configuration has been detected.	Check the circuit wiring and end device of the partner. If no problem found, replace module.	

## 1734-OBV2S Safety Output Status

Indicator		Description	Recommended Action
0...3	Off	Safety output is off, or module is being configured.	Turn on the safety output or reconfigure the channel, if desired.
	Yellow	Safety output is on.	None.
	Red	A fault in the output circuit has been detected.	Check the circuit wiring and end device. If no problem found, replace module.
		The tag values do not have the same value.	Make sure that logic is driving tag values to the same state (off or on).
Flashing red	A fault in the partner output circuit has been detected.	Check the circuit wiring and end device of the partner. If no problem found, replace module.	

**Notes:**

## Get I/O Diagnostic Status from Modules in Logix Systems

Topic	Page
Message Instructions	167
Configure the Message Instruction	168
Class, Instance, and Attribute Data for I/O Modules	169

You can use message instructions in a Logix system to determine the cause of input point or output point faults.

### Message Instructions

When the controller detects a fault on an input or output point, you can use a message instruction to retrieve the cause of the fault.

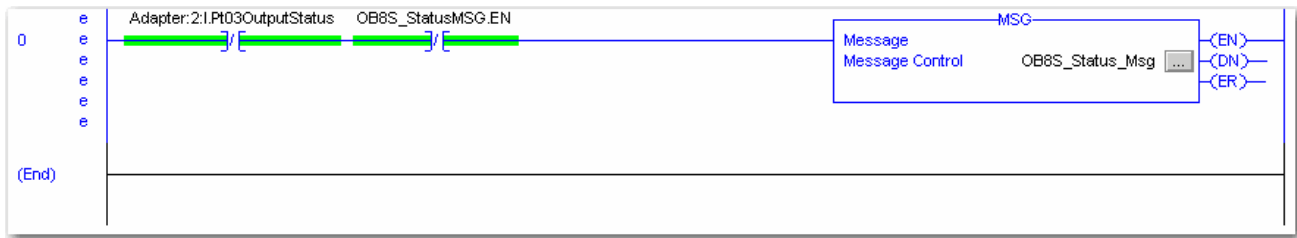
In this example, we use a 1734-OB8S module with the Input Status set to return Point Status. This table illustrates the controller tags that you can monitor for this module.

Adapter:2:1.Pt000OutputStatus	0	Decimal	BOOL	Safety
Adapter:2:1.Pt010OutputStatus	0	Decimal	BOOL	Safety
Adapter:2:1.Pt020OutputStatus	0	Decimal	BOOL	Safety
Adapter:2:1.Pt030OutputStatus	0	Decimal	BOOL	Safety
Adapter:2:1.Pt040OutputStatus	0	Decimal	BOOL	Safety
Adapter:2:1.Pt050OutputStatus	0	Decimal	BOOL	Safety
Adapter:2:1.Pt060OutputStatus	0	Decimal	BOOL	Safety
Adapter:2:1.Pt070OutputStatus	0	Decimal	BOOL	Safety

Use the Point Output Status bits to detect if one or more of the output points on the module have a fault:


- If any status bit goes to a value of 0 (0 = error, 1 = no error), use the status bit to condition your message instruction as follows.
- Place these rungs in the standard task.

This sample ladder logic is monitoring the status of output point 3. This ladder logic rung examines the Output Point Status and, when a fault is detected (0 = error), the message instruction is executed.



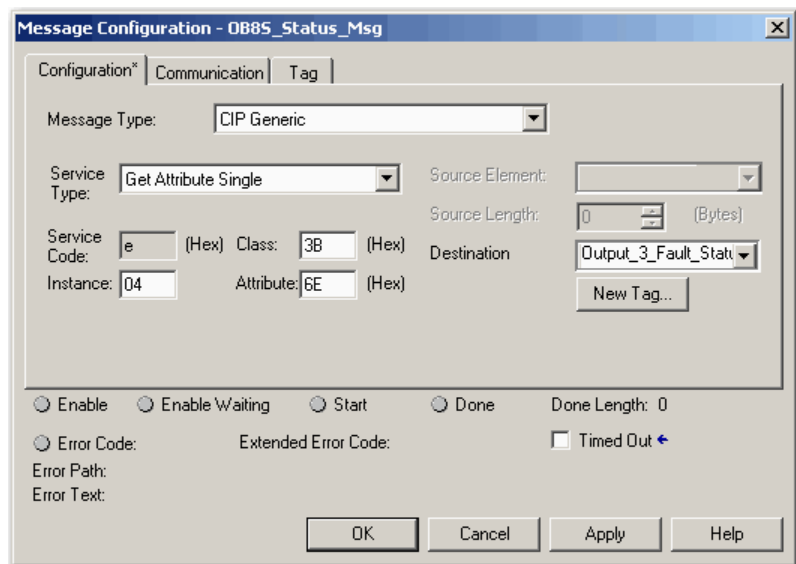
## Configure the Message Instruction

Follow this procedure to edit the Message Configuration dialog box.

1. In the Message Instruction in the ladder logic, click the  icon.
2. On the Configuration tab, enter the appropriate data for what you want to monitor.
  - a. From the Service Type pull-down menu, choose Get Attribute Single.
  - b. Enter the Class, Instance, and Attribute data, that refers to the appropriate tables on pages [169...170](#).
3. On the Communication tab, specify the path for the message.

This example illustrates values that you enter to determine the reason for the fault on Output 3.

**Figure 52 - Message Instruction Configuration Example**



**TIP** When entering the Instance value, enter the input/output point plus 1. In this example, Output Point 3 is Instance 4.

## Class, Instance, and Attribute Data for I/O Modules

Use the information in the following tables to configure your message instruction.

**Table 14 - Digital Safety Input Module - 1734-IB85**

Service Type	Function	Command (hex)					Response (hex)
		Service Code	Class ID	Instance ID	Attribute ID	Data Size	
Get Attribute Single	Reads the cause for the safety digital input fault that is specified by the Instance ID (1...8).	0E	3D	01...08	6E	-	0: No error 01: Configuration invalid 02: External test signal error 03: Internal input error 04: Discrepancy error 05: Error in the other dual channel input

**Table 15 - Digital Safety Input Module Test Outputs - 1734-IB85**

Service Type	Function	Command (hex)					Response (hex)
		Service Code	Class ID	Instance ID	Attribute ID	Data Size	
Get Attribute Single	Reads the cause of the test output fault that is specified by the Instance ID (1...4).	0E	09	01...04	76	-	0 = No error 01: Configuration invalid 02: Overload detected 03: Cross circuit detected 05: Output ON error 06: Undercurrent detected for muting lamp
Set Attribute Single	Configures the test output to turn off or hold its last state after a communication error for an output that is specified by the Instance ID.	10	09	01...04	05	1 byte 00: Clear 01: Hold	-

**Table 16 - Digital Safety Output Module - 1734-OB85**

Service Type	Function	Command (hex)					Response (hex)
		Service Code	Class ID	Instance ID	Attribute ID	Data Size	
Get Attribute Single	Reads the cause for the safety digital output fault that is specified by the Instance ID (1...8).	0E	3B	01...08	6E	-	0: No error 01: Configuration invalid 02: Over current detected 03: Short circuit detected 04: Output ON error 05: Error in the other dual channel output 06: N/A 07: N/A 08: Dual channel violation 09: Short circuit detected at safety output

**Table 17 - Digital Safety Discrete Output Module - 1734-OBV25**

Service Type	Function	Command (hex)					Response (hex)
		Service Code	Class ID	Instance ID	Attribute ID	Data Size	
Get Attribute Single	Reads the cause for the safety digital output fault that is specified by the Instance ID (1...4).	0E	3B	01...04	6E	-	0: No alarm 01: Configuration invalid 02: Over current detected 03: Short circuit detected 04: Output ON error 05: Error in the partner dual channel output 06: N/A 07: N/A 08: Dual channel violation 09: Short circuit detected at safety output

**Table 18 - Safety Analog Input Module (1734-IE4S)**

Service Type	Function	Command (hex)					Response (hex) <sup>(1)</sup>
		Service Code	Class ID	Instance ID	Attribute ID	Data Size	
Get Attribute Single	Reads the cause of the safety analog input fault that is specified by the Instance ID (1...4).	0E	49	01...04	6	-	00: Reserved 01: No error 02: Signal over-range 03: Signal under-range 04: Signal test failure 05: Dual-channel discrepancy 06: Error in the other dual-channel input 08: Reserved 100: Sensor supply overcurrent 101: Sensor supply undercurrent 102: Analog-digital converter (ADC) CPU Timing Fault <sup>(2)</sup> 103: 3.3V undervoltage 104: 3.3V overvoltage 105: CPU fault 106: Flash fault 107: RAM fault 108: Single-channel discrepancy 109: Tach Dual Low 110: Undefined error 111: Flash enable fault 112: Serial pattern fault 113: Channel uniqueness fault 114: Watchdog fault 115: Sync timeout fault 116: Missing clock fault 117: SCI Tx fault 118: ADC fault 119: ADC neighbor 1.8V fault 120: ADC channel configuration mismatch 121: SPI sequence number mismatch 122: Runtime 3.3V over- or undervoltage error 123: Reserved 124: Reserved 125: Field I/O power is missing 126: Startup 3.3V over- or undervoltage error 127: Sensor power/input wiring error
Get Attribute Single	Reads the data that is associated with the given instance of the defined assembly	0E	4	946	3	6 <sup>(3)</sup>	Input power

(1) See the fault code definitions in Table 16 for details.

(2) Missing clock, watchdog timeout.

(3) For this instance, specify the Destination Tag to be a SINT[6].

**Table 19 - Fault Code Definitions for 1734-IE4S Modules**

<b>Fault Code</b>	<b>Description</b>	<b>Definition</b>	<b>Recommended Action</b>
2	Signal Over Range	Exceeded configured range.	Check field wiring and/or power.
3	Signal Under Range	Under configured range.	Check field wiring and/or power.
4	Signal Test Failure	Undefined error for IE4S.	If the problem persists, replace module.
5	Dual Channel Discrepancy	Exceeded tolerance between dual channels.	Check field sensors to determine cause of discrepancy.
6	Error in other Dual Channel Input	Partner channel faulted.	Troubleshoot partner channel fault.
100	Sensor Supply Overcurrent	Exceeded specification.	Check field wiring and sensor power draw.
101	Sensor Undercurrent	Too little current drawn from sensor power.	Check field wiring and sensor power draw.
102	ADC CPU Timing Fault	ADC missed a clock, failed a sync, or watchdog (combination flag).	If the problem persists, replace module.
103	3.3V Undervoltage	3.3V supply voltage was detected too low.	If the problem persists, replace module.
104	3.3V Overvoltage	3.3V supply voltage was detected too high.	If the problem persists, replace module.
105	CPU Fault	ADC failed register, instruction, or flag diagnostic.	If the problem persists, replace module.
106	Flash Fault	FLASH test detected bit errors.	If the problem persists, replace module.
107	RAM fault	RAM test detected bit errors.	If the problem persists, replace module.
108	Single Channel Discrepancy	Dual measurements of single channel disagree.	If the problem persists, replace module.
109	Tach Dual Low	Both channels LO at same time.	Check sensor signal timing.
110	Undefined Error	Undefined error.	If the problem persists, replace module.
111	Flash Enable Fault	ADC's nonvolatile memory drawing too much current (micro jumped to nonvolatile for some reason).	If the problem persists, replace module.
112	Serial Pattern Fault	Serial communication pattern errors detected.	Check field wiring for proper grounding/shielding. Verify that the temperature within the enclosure is not excessive. If the problem persists, replace module.
113	Channel Uniqueness Fault	Pulse test of ADC multiplexor revealed improper channel.	If the problem persists, replace module.
114	Watchdog Fault	ADC watchdog timed out.	If the problem persists, replace module.
115	Sync Timeout Fault	ADC conversion out of sync.	If the problem persists, replace module.
116	Missing Clock fault	ADC detected a missing clock.	If the problem persists, replace module.
117	SCI Tx fault	Serial communication bit errors detected.	Check field wiring for proper grounding/shielding. Verify that temperature within enclosure is not excessive. If the problem persists, replace module.
118	ADC fault	ADC test pattern failure.	If the problem persists, replace module.
119	ADC neighbor 1.8V fault	ADC detected out-of-range voltage on its partner.	If the problem persists, replace module.
120	ADC channel config mismatch	Dual ADCs are not configured the same.	If the problem persists, replace module.
121	SPI sequence number mismatch	Serial communication state machines are out of sync.	If the problem persists, replace module.
122	Runtime 3.3V over/under error	3.3V supply voltage was detected too high or too low.	If the problem persists, replace module.
125	Field I/O power is missing	24V power is not within specification.	Check field power supply and wiring.
126	Startup 3.3V over/under error	OV-UV detector failed startup test.	If the problem persists, replace module.
127	Sensor power/input wiring error	Sensor power to input signal violation detected.	Check field wiring.

**Notes:**



## Specifications

Topic	Page
Technical Specifications for Series A Modules	173
Technical Specifications for Series B Modules	185
Safety Digital Output Module Specifications 1734-OBV2S	190
Environmental Specifications	192
Certifications	195
Standards	195

### Technical Specifications for Series A Modules

### Safety Digital Input Module Specifications

Attribute	1734-IB85 Series A
<b>Safety Input</b>	
Inputs per module	8
Input type	Current sinking
Voltage, on-state input	11...30V, 3.5 mA DC
Voltage, off-state input, max	5V, 3.5 mA DC
Current, on-state input, min	3.3 mA
Current, off-state, max	1.3 mA
IEC 61131-2 (input type)	Type 3
Reaction time	<16.2 ms
<b>Pulse Test Output</b>	
Output type	Current sourcing
Number of sources (T0, T1M, T2, T3M)	4
Test output current (each output point)	0.7 A max
Aggregate current of test outputs per module	2.8 A @ 40 °C (104 °F)
Pulse width	525 μs
Pulse period	144 ms
Maximum field capacitance limit that is permitted per test output	100 nF
Current, max (when used to control muting lamp)	25 mA (to avoid fault when used as a muted lamp output)
Current, min (when used to control muting lamp)	5 mA (at which fault indication is generated when used as a muted lamp output)

Attribute	1734-IB85 Series A
1734-IB85 temperature vs. current derating for both horizontal and vertical installations	
Residual voltage, max	0.3V
Output leakage current, max	0.1 mA
Short circuit protection	Yes
<b>POINTBus™</b>	
POINTBus current, max	175 mA
Power dissipation, max <sup>(1)</sup>	3.4 W
Power dissipation, typical	2.44 W
Thermal dissipation, max	11.62 BTU/hr
Isolation voltage	50V (continuous), Basic Insulation Type between field side and system No isolation between individual channels Type tested at 707V DC for 60 s
Power bus, operating supply voltage	24V DC nom
Power bus, operating voltage range	19.2 . . . 28.8V DC
Power bus current (No Load), max	25 mA
Input filter time, OFF to ON <sup>(2)</sup>	0 . . . 126 ms (in 6 ms increments)
Input filter time, ON to OFF <sup>(2)</sup>	
Indicators	1 yellow lock status indicator 1 green/yellow power status indicator 8 I/O channel status indicators
Keyswitch positions (left and right)	1734-IB85: Key 1 = 8 (left); Key 2 = 1 (right) 1734-OB85: Key 1 = 8 (left); Key 2 = 2 (right)
North America temp code	T4
IEC temp code	T4
Enclosure type rating	None (open-style)
Wiring category <sup>(3)</sup>	2 - on signal ports
Wire size	Determined by installed terminal block
Terminal block torque	Determined by installed terminal block
Weight, approx	62.4 g (2.2 oz)
Dimensions (HxWxD), approx (without terminal block)	77 x 25 x 55 mm (3.03 x 0.98 x 2.17 in.)

- (1) Maximum power dissipation applies when using 28.8V DC module supply, 30V DC on all inputs and maximum power dissipated with all four test outputs in the ON state.
- (2) Input off-to-on filter time is the time from a valid input signal to recognition by the module. Input on-to-off time is the time from a valid input signal to recognition by the module.
- (3) Use this conductor category information for planning conductor routing. See the Industrial Automation Wiring and Grounding Guidelines, publication [1770-4.1](#).

## Safety Digital Output Module Specifications

Attribute	1734-OB85 Series A
<b>Safety Output</b>	
Outputs per module	8
Output type	Current sourcing
Output current (each output point)	1 A max
Pulse width	475 $\mu$ s
Pulse period	575 ms
Maximum field capacitance limit permitted per output	950 nF
On-state voltage drop	0.165V
Leakage current, max	0.1 mA
Short-circuit detection	Yes (short high and low and cross-circuit fault detect)
Short-circuit protection	Electronic
Aggregate current of outputs per module	8 A (4 A per terminal base) @ 40 °C (104 °F)
1734-OB85 temperature vs. current derating for both horizontal and vertical installations	
Reaction time	<6.2 ms
<b>POINTBus</b>	
POINTBus current, max	190 mA
Power dissipation, max <sup>(1)</sup>	4.5 W
Power dissipation, typical	3.02 W
Thermal dissipation, max	15.38 BTU/hr
Isolation voltage	50V (continuous), Basic Insulation Type between field side and system No isolation between individual channels Type tested at 707V DC for 60 s
Power bus, operating supply voltage	24V DC nom
Power bus, operating voltage range	19.2...28.8V DC
Power bus current (No Load), max	75 mA
Indicators	1 yellow lock status indicator 1 green/yellow power status indicator 8 I/O channel status indicators
Keyswitch positions (left and right)	Key 1 = 8 (left); Key 2 = 2 (right)
Pilot duty rating	Not rated
North America temp code	T4

Attribute	1734-OB8S Series A
IEC temp code	T4
Enclosure type rating	None (open-style)
Wiring category <sup>(2)</sup>	2 - on signal ports
Wire size	Determined by installed terminal block
Terminal block torque	Determined by installed terminal block
Weight, approx	62.4 g (2.2 oz)
Dimensions (HxWxD), approx (without terminal block)	77 x 25 x 55 mm (3.03 x 0.98 x 2.17 in.)

- (1) Maximum power dissipation applies when using 28.8 V DC module supply and maximum power dissipated for all eight outputs in the ON state.
- (2) Use this conductor category information for planning conductor routing. See the Industrial Automation Wiring and Grounding Guidelines, publication [1770-4.1](#).

## Safety Analog Input Module Specifications

Attribute	1734-IE4S Series A
<b>Safety Analog Input</b>	
Inputs per module	4 single-ended
Input type	Software-configurable for voltage, current, or tachometer
Input voltage mode ranges	$\pm 5V$ , $\pm 10V$ , $0 \dots 5V$ , $0 \dots 10V$
Input current mode ranges	$0 \dots 20$ mA, $4 \dots 20$ mA
Input tachometer mode ranges	$0 \dots 24V$ with configurable ON and OFF thresholds in 1V increments
Voltage code range	Bipolar modes: -32768/+32767 Unipolar modes: 0/+32767
Current code range ( $4 \dots 20$ mA mode)	-8192...32767
Tachometer code range	$0 \dots 1000$
Voltage overrange thresholds	@ $\pm 10V$ : 10.0V      @ $\pm 5V$ : 5.0V @ $0 \dots 10V$ : 10.0V      @ $0 \dots 5V$ : 5.0V
Voltage underrange thresholds	@ $\pm 10V$ : -10.0V      @ $\pm 5V$ : -5.0V @ $0 \dots 10V$ : 0.5V      @ $0 \dots 5V$ : 0.25V
Current overrange thresholds	@ $0 \dots 20$ mA: 20.0 mA      @ $4 \dots 20$ mA: 20.0 mA
Current underrange thresholds	@ $0 \dots 20$ mA: 0.5 mA      @ $4 \dots 20$ mA: 4.0 mA
Tachometer frequency range	$1 \dots 1000$ Hz
Tachometer overrange threshold	1 kHz
ADC resolution	12 bits
Filter	Single-pole anti-aliasing filter: <ul style="list-style-type: none"> <li>Filter frequency = 10 Hz</li> </ul> Followed by four-pole digital filter Available corner frequencies, approx. <ul style="list-style-type: none"> <li>1 Hz</li> <li>5 Hz</li> <li>10 Hz</li> <li>50 Hz</li> </ul>
Step response to 63% (approx.) <sup>(1)</sup>	Filter frequency @ 1 Hz = 450 ms Filter frequency @ 5 Hz = 125 ms Filter frequency @ 10 Hz = 72 ms Filter frequency @ 50 Hz = 25 ms



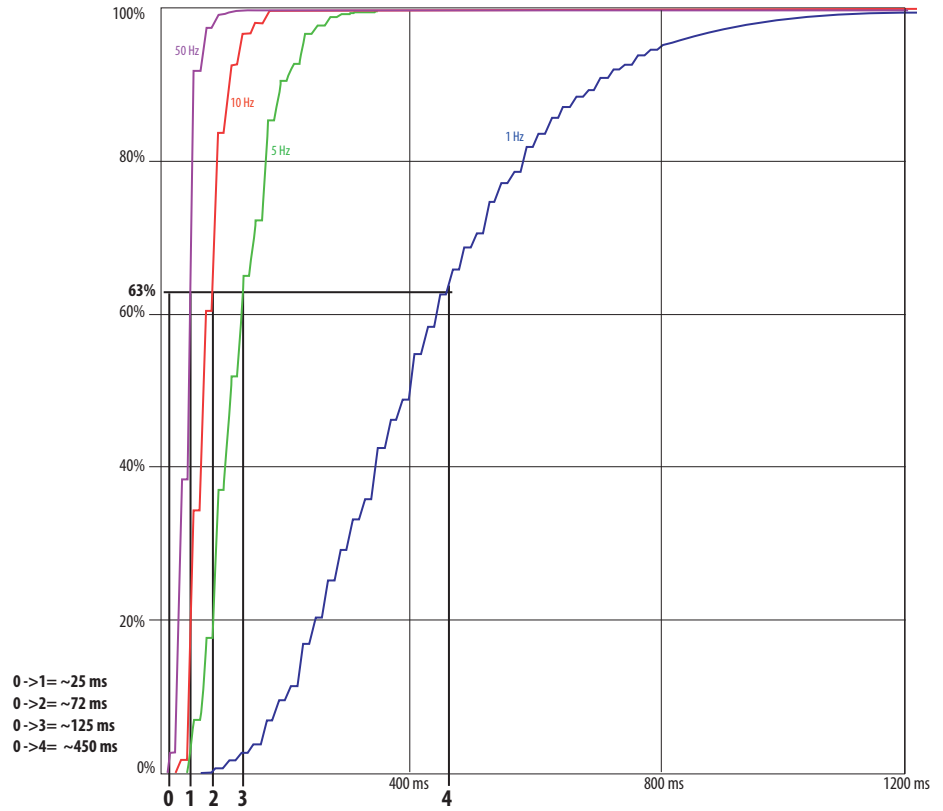
Attribute	1734-IE4S Series A
<b>POINTBus</b>	
POINT Bus current, max	110 mA @ 5V
Power Dissipation, max	2.2 W
Thermal Dissipation, max	7.5 BTU/hr
Field Power Input	19.2...28.8V DC, 65 mA, Class 2
<b>Sensor Output</b>	
Output type	Sensor power supply, 24V DC
Rated output current per point	150 mA max. per output @ 55°C (131 °F)
On-state voltage drop	≤ 0.5V
Leakage current, max	< 0.1 mA
Over current detection	Yes
Open load detection	Yes
Sensor Supply Undercurrent Fault	Detected at < 4.0 mA (2.5 mA typical)
Aggregate current of sensor outputs per module	600 mA

- (1) For more information, see [Step Response and Filter Response for 1734-IE4S Modules on page 179](#).
- (2) Use this conductor category information for planning conductor routing. See the Industrial Automation Wiring and Grounding Guidelines, publication [1770-4.1](#).
- (3) For more information, see [Figure 62, Accuracy Drift vs. Temperature \(Current mode\) on page 184](#).

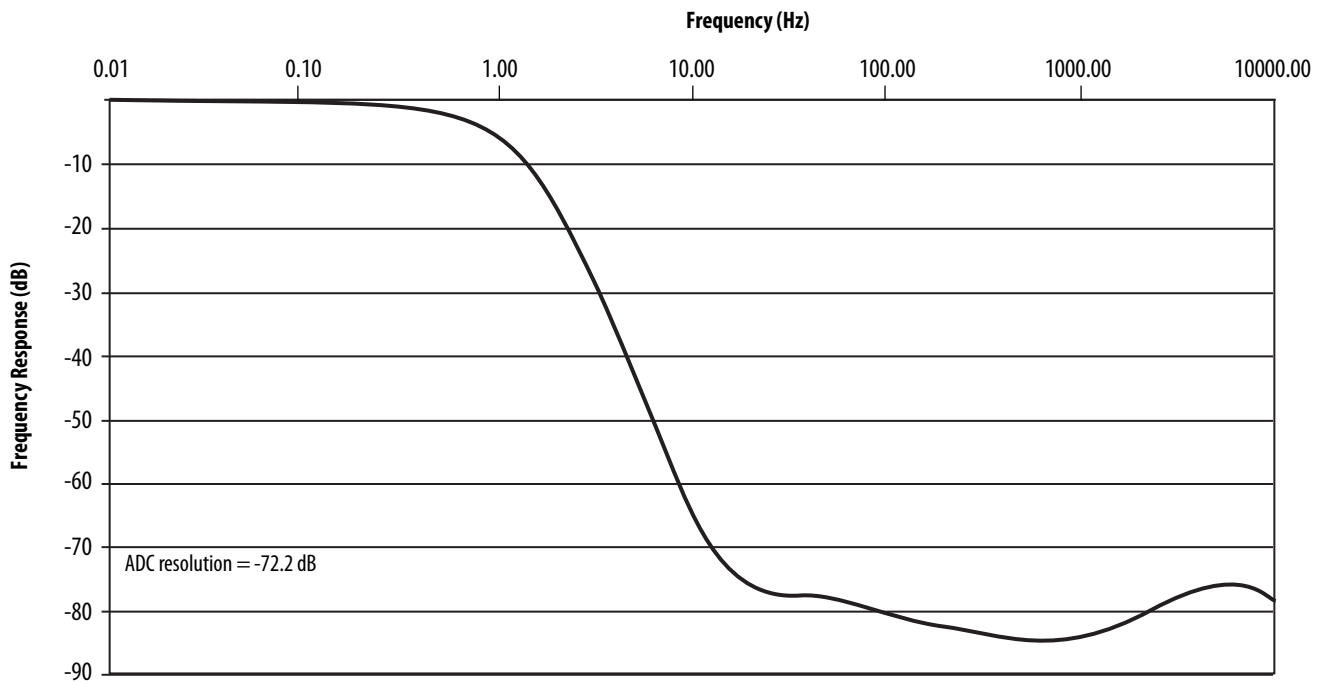
*Step Response and Filter Response for 1734-IE4S Modules*

Filter Setting	Step Response to 63%	Corner Frequency-3 dB
50 Hz	~ 25 ms	10.2 Hz
10 Hz	~ 72 ms	4.75 Hz
5 Hz	~ 125 ms	2.62 Hz
1 Hz	~ 450 ms	0.68 Hz

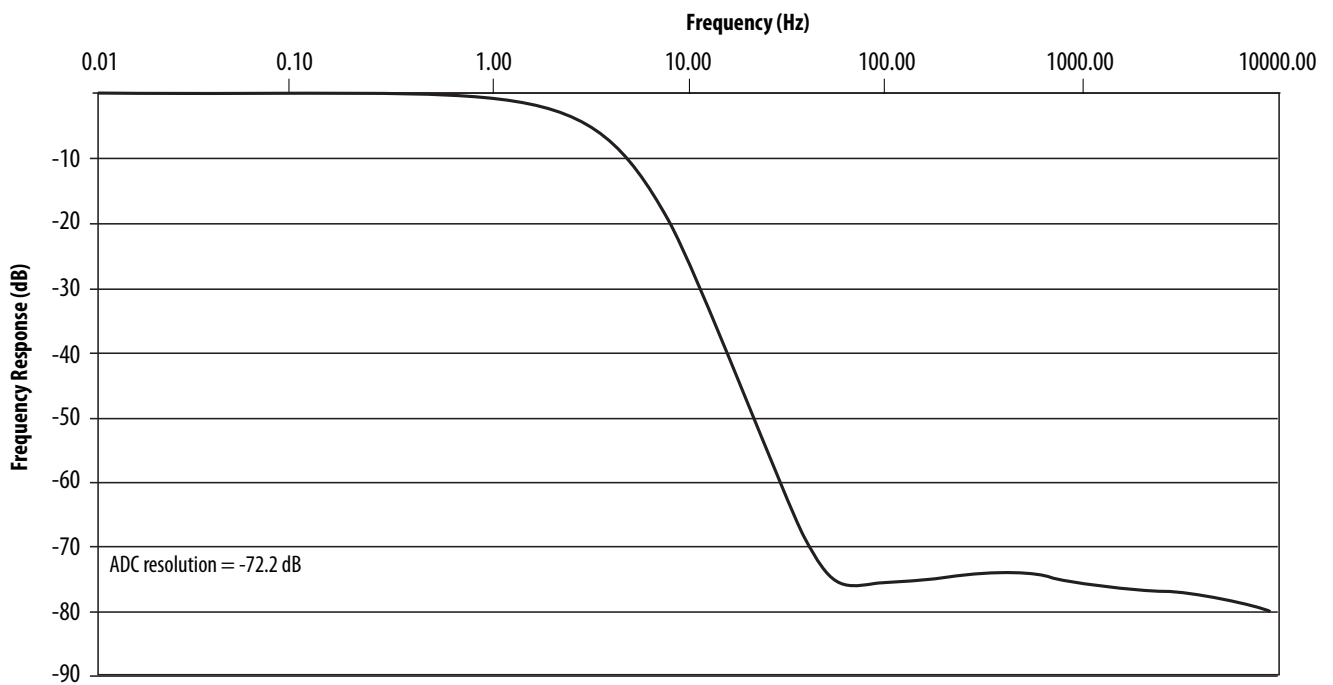
**Figure 53 - Step Response**



**Figure 54 - Frequency Response of Current Input with Filter = 1 Hz**

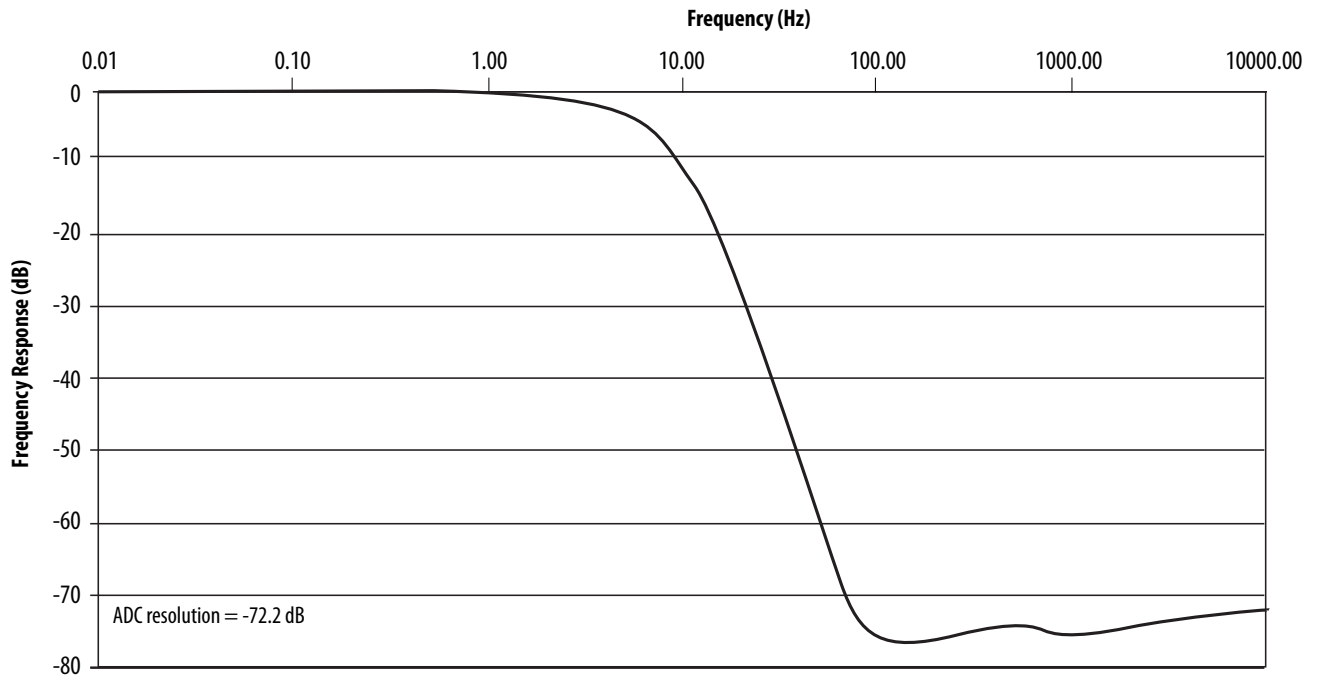


**Figure 55 - Frequency Response of Current Input with Filter = 5 Hz**





**Figure 56 - Frequency Response of Current Input with Filter = 10 Hz**



**Figure 57 - Frequency Response of Current Input with Filter = 50 Hz**

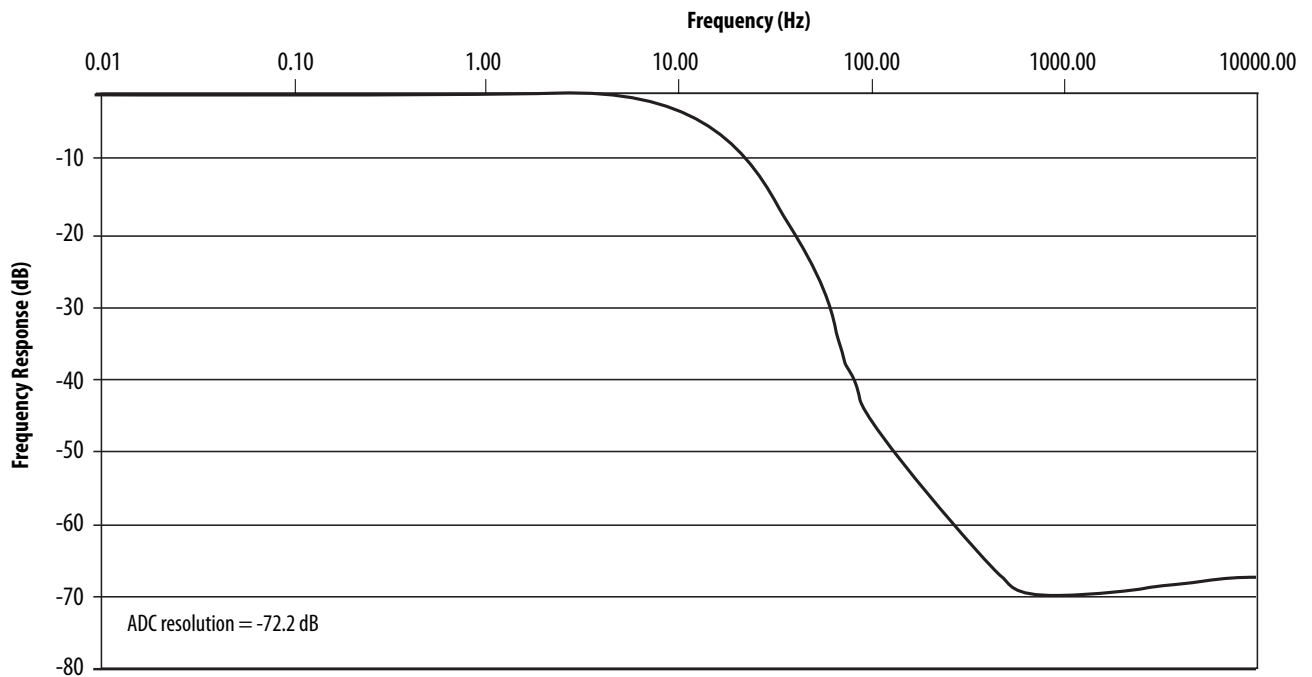


Figure 58 - Frequency Response of Voltage Input with Filter = 1 Hz

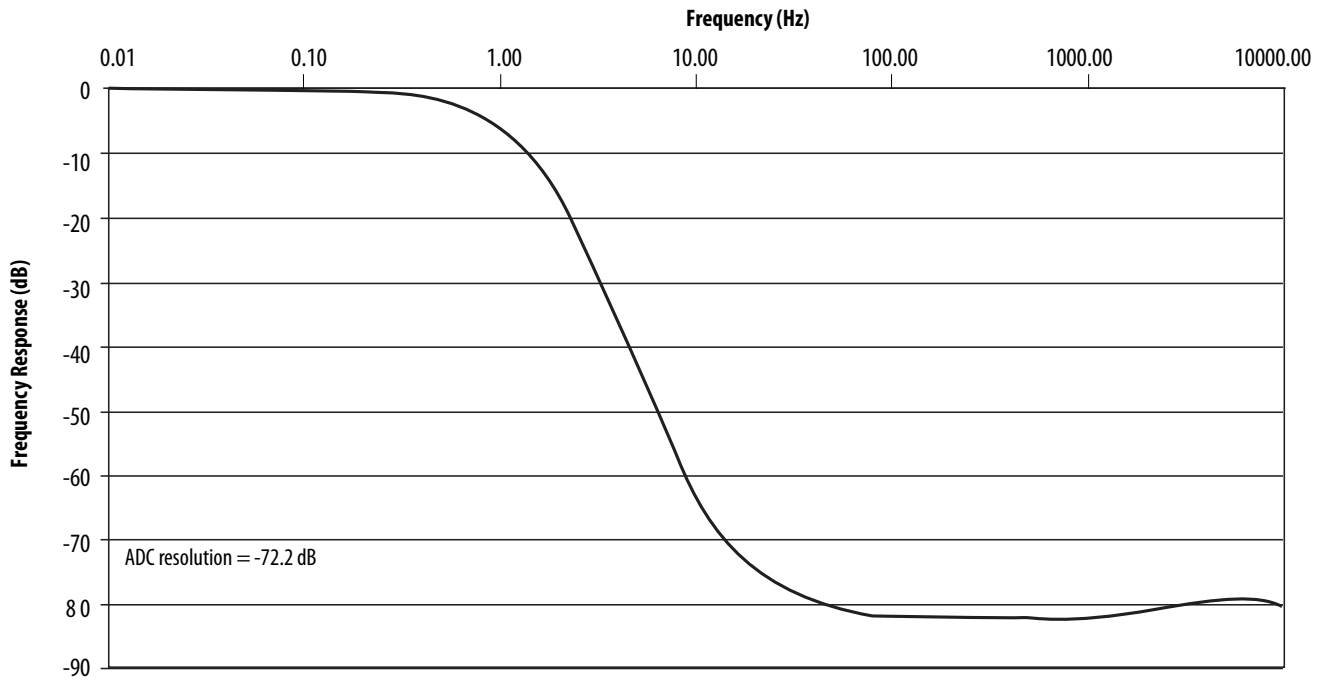
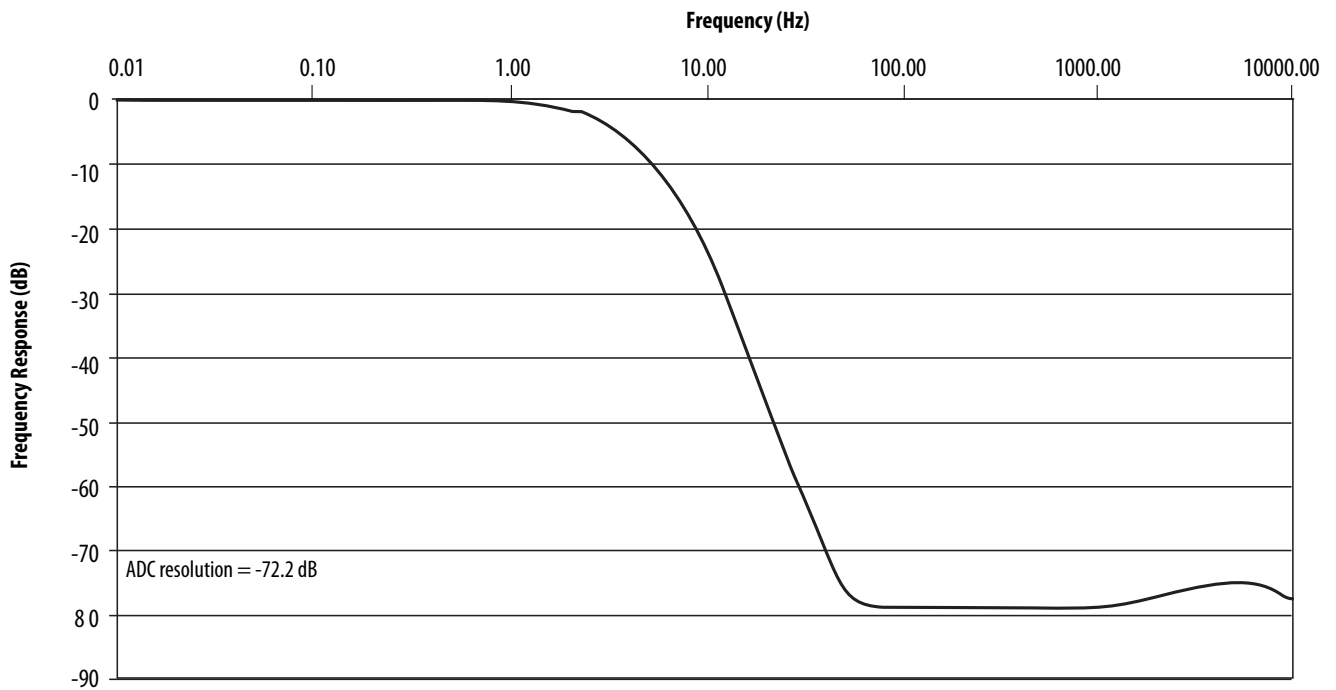
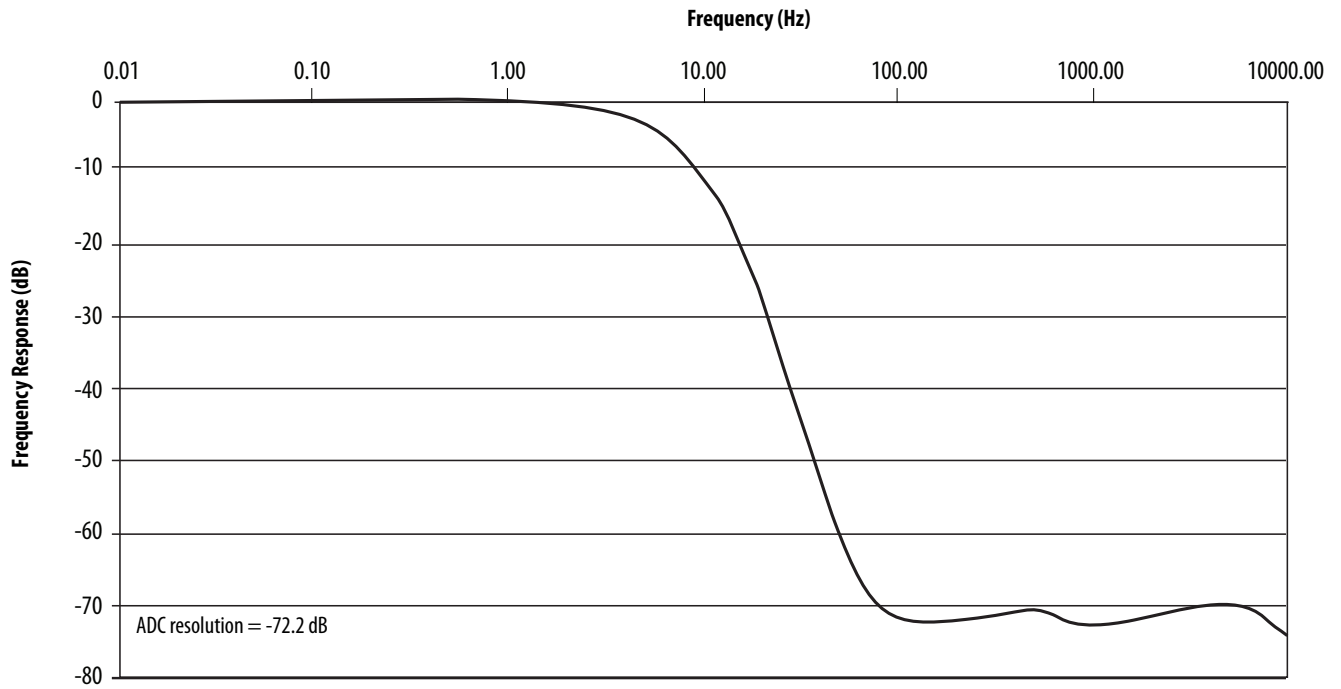


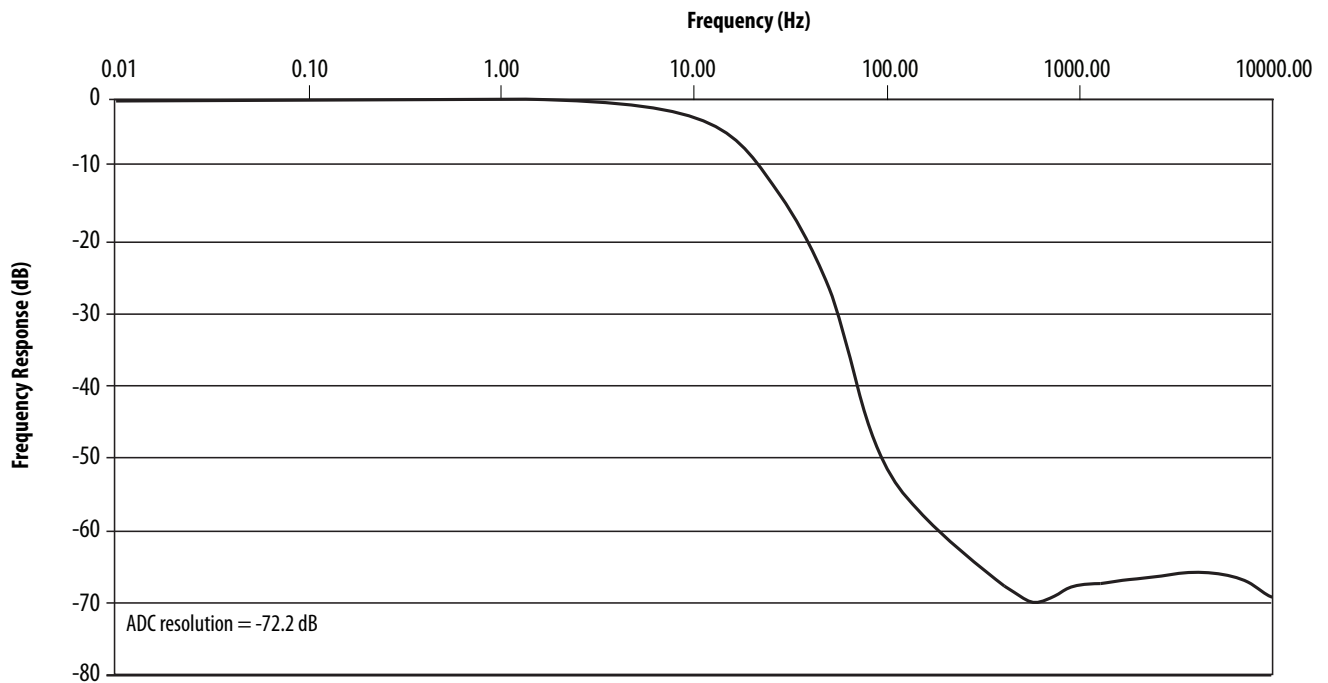
Figure 59 - Frequency Response of Voltage Input with Filter = 5 Hz



**Figure 60 - Frequency Response of Voltage Input with Filter = 10 Hz**



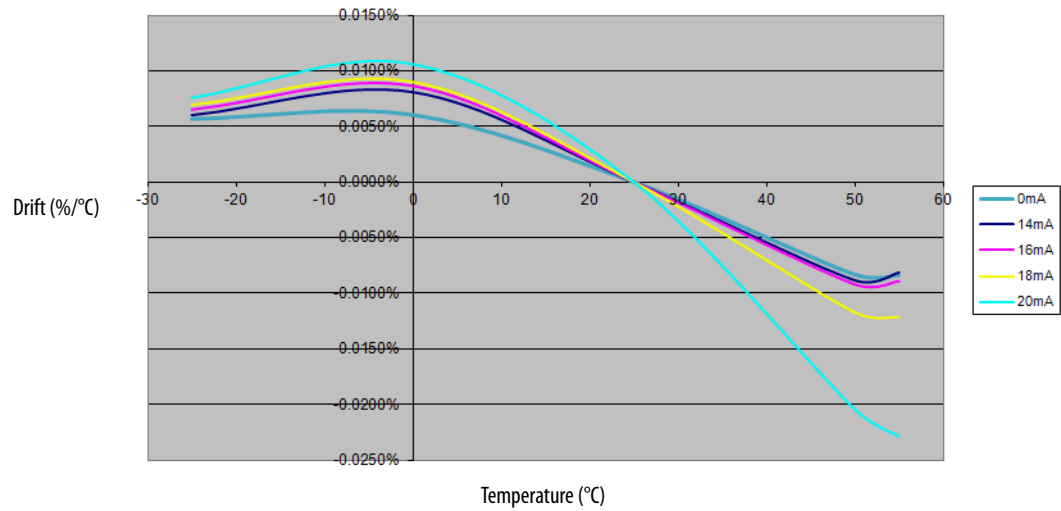
**Figure 61 - Frequency Response of Voltage Input with Filter = 50 Hz**



### Drift and Temperature

In Current mode, the accuracy drift of the 1734-IE4S module is very dependent on the temperature of the module and the amount of current being measured. As shown in [Figure 62](#) below, the drift of the module increases greatly when currents above 16 mA are measured. To help preserve the accuracy of the 1734-IE4S module in Current mode, choose a sensor for your application that can operate in the middle of its range and not at the outer limits.

**Figure 62 - Accuracy Drift vs. Temperature (Current mode)**



## Technical Specifications for Series B Modules

## Safety Digital Input Module Specifications

Attribute	1734-IB85 Series B
<b>Safety Input</b>	
Inputs per module	8
Input type	Current sinking
Voltage, on-state input	11...30V DC, 3.5 mA @ 40 °C (104 °F), Class 2 11...28.8V DC, 3.5 mA @ 55 °C (131 °F), Class 2
1734-IB85 Series B temperature vs. safety input voltage (max) derating for both horizontal and vertical installations	
Voltage, off-state input, max	5V DC
Current, on-state input, min	3.3 mA
Current, off-state, max	1.3 mA
IEC 61131-2 (input type)	Type 3
Reaction time	<16.2 ms
<b>Pulse Test Output</b>	
Output type	Current sourcing
Number of sources (T0, T1M, T2, T3M)	4
Test output current (each output point)	0.7 A @ 40 °C (104 °F) 0.5 A @ 55 °C (131 °F)
1734-IB85 Series B temperature vs. current per test output point derating for both horizontal and vertical installations	
Aggregate current of test outputs per module	2.8 A @ 40 °C (104 °F) 0.55 A @ 55 °C (131 °F)

Attribute	1734-IB8S Series B
1734-IB8S Series B temperature vs. aggregate current per module derating for both horizontal and vertical installations	<p>The graph plots aggregate current per module (A) against temperature (°C and °F). The current is constant at 2.8 A from -20°C (-4°F) to 40°C (104°F). From 40°C (104°F) to 55°C (131°F), the current derates linearly to 0.55 A. The current remains at 0.55 A for temperatures above 55°C.</p>
Pulse width	525 μs
Pulse period	144 ms
Maximum field capacitance limit permitted per test output	100 nF
Current, max (when used to control muting lamp)	25 mA (to avoid fault when used as a muted lamp output)
Current, min (when used to control muting lamp)	5 mA (at which fault indication is generated when used as a muted lamp output)
Residual voltage, max	0.3V
Output leakage current, max	0.1 mA
Short circuit protection	Yes
<b>POINTBus</b>	
POINTBus current, max	110 mA
Power dissipation, max <sup>(1)</sup>	3.0 W
Thermal dissipation, max	10.25 BTU/hr
Power dissipation, typical <sup>(2)</sup>	2.25 W
Isolation Voltage	50V (continuous), Basic Insulation Type between field side and system. No isolation between individual channels. Type tested at 500V AC for 60 s.
Pilot duty rating	Test Outputs: Not rated
North America temp code	T4
ATEX temp code	T4
Power bus, operating supply voltage	24V DC nom, Class 2
Power bus, operating voltage range	19.2 . . . 28.8V DC, Class 2
Power bus current (no load), max	25 mA

<b>Attribute</b>	<b>1734-IB85 Series B</b>
Input filter time, OFF to ON <sup>(3)</sup>	0...126 ms (in 6 ms increments)
Input filter time, ON to OFF <sup>(2)</sup>	
Indicators	1 yellow lock status indicator 1 green/yellow power status indicator 8 I/O channel status indicators
Keyswitch positions (left and right)	Key 1 = 8 (left); Key 2 = 1 (right)
North America temp code	T4
IEC temp code	T4
Enclosure type rating	None (open-style)
Wiring category <sup>(4)</sup>	2 - on signal ports
Wire size	Determined by installed terminal block
Terminal block torque specs	Determined by installed terminal block
Weight, approx.	62.4 g (2.2 oz)
Dimensions (HxWxD), approx. (without terminal block)	77 x 25 x 55 mm (3.03 x 0.98 x 2.17 in.)

- (1) Maximum power dissipation applies when using 28.8V DC module supply, 30V DC on all inputs and maximum power dissipated with all four test outputs in the ON state.
- (2) Typical power dissipation applies when using 24V DC module supply, 24V DC on all inputs and nominal power dissipated with all four test outputs in the ON state.
- (3) Input off-to-on filter time is the time from a valid input signal to recognition by the module. Input on-to-off time is the time from a valid input signal to recognition by the module.
- (4) Use this conductor category information for planning conductor routing. See the Industrial Automation Wiring and Grounding Guidelines, publication [1770-4.1](#).

## Safety Digital Output Module Specifications

Attribute	1734-OB8S Series B
<b>Safety Output</b>	
Outputs per module	8
Output type	Current sourcing
Output current (each output point), max	1 A @ 40 °C (104 °F) 0.5 A @ 55 °C (131 °F)
1734-OB8S Series B temperature vs. current per output point derating for both horizontal and vertical installations	<p>The graph plots current per output point (A) on the y-axis against temperature (°C and °F) on the x-axis. The y-axis has markers at 0.5 A and 1 A. The x-axis has markers at -20 °C (-4 °F), 40 °C (104 °F), and 55 °C (131 °F). The current is constant at 1 A from -20 °C to 40 °C. From 40 °C to 55 °C, the current derates linearly to 0.5 A.</p>
Aggregate current of outputs per module <sup>(1)</sup>	8 A (4 A per terminal base) @ 40 °C (104 °F) 2 A (1A per terminal base) @ 55 °C (131 °F)
1734-OB8S Series B temperature vs. aggregate current per module derating for both horizontal and vertical installations <sup>(1)</sup>	<p>The graph plots aggregate current per module (A) on the y-axis against temperature (°C and °F) on the x-axis. The y-axis has markers at 2 A and 8 A. The x-axis has markers at -20 °C (-4 °F), 40 °C (104 °F), and 55 °C (131 °F). The current is constant at 8 A from -20 °C to 40 °C. From 40 °C to 55 °C, the current derates linearly to 2 A.</p>
Pulse width	475 μs
Pulse period	575 ms
Maximum field capacitance limit permitted per output	950 nF
On-state voltage drop	0.165V
Leakage current, max	0.1 mA
Short-circuit detection	Yes (short high and low and cross-circuit detect)
Short-circuit protection	Electronic
Reaction time	<6.2 ms
<b>POINTBus</b>	
POINTBus current, max	125 mA
Power dissipation, max <sup>(2)</sup>	3.5 W
Thermal dissipation, max	11.96 BTU/hr
Power dissipation, typical <sup>(3)</sup>	2.5 W
Isolation voltage	50V (continuous), Basic Insulation Type between field side and system No isolation between individual channels Type tested at 860V AC DC for 60 s
Power bus, operating supply voltage	24V DC nom, Class 2



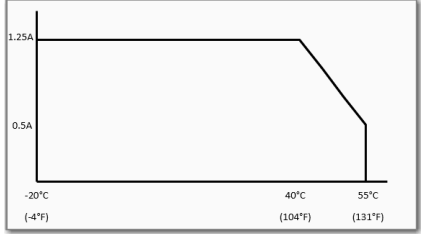
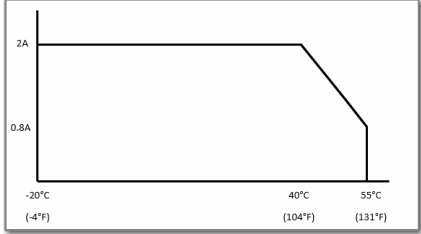
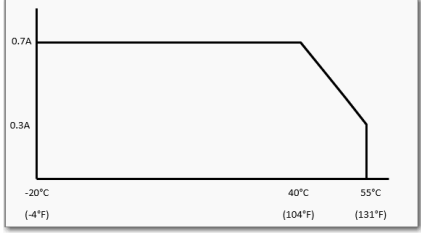
<b>Attribute</b>	<b>1734-0B85 Series B</b>
Power bus, operating voltage range	19.2...28.8V DC, Class 2
Power bus current (no load), max	50 mA
Indicators	1 yellow lock status indicator 1 green/yellow power status indicator 8 I/O channel status indicators
Keyswitch positions (left and right)	Key 1 = 8 (left); Key 2 = 2 (right)
Pilot duty rating	Not rated
North America temp code	T4
ATEX temp code	T4
IECEx temp code	T4
Enclosure type rating	None (open-style)
Wiring category <sup>(4)</sup>	2 - on signal ports
Wire size	Determined by installed terminal block
Terminal block torque	Determined by installed terminal block
Weight, approx.	62.4 g (2.2 oz)
Dimensions (HxWxD), approx. (without terminal block)	77 x 25 x 55 mm (3.03 x 0.98 x 2.17 in.)

- (1) To comply with UL certification requirements, field power must be supplied from one Class 2 compliant power supply (See [Choosing a Power Supply on page 43](#)) which limits available field power to 100VA. Therefore, the aggregate current of outputs per module is limited to a maximum set by the 100VA limit (unless derated further as shown) for applications that require UL listing.
- (2) Maximum power dissipation applies when using 28.8V DC module supply and maximum power dissipated with all eight outputs in the ON state.
- (3) Typical power dissipation applies when using 24V DC module supply and nominal power dissipated with all eight outputs in the ON state.
- (4) Use this conductor category information for planning conductor routing. See the Industrial Automation Wiring and Grounding Guidelines, publication [1770-4.1](#).

## Safety Digital Output Module Specifications 1734-OBV2S

These are the technical specifications for the 1734-OBV2S safety digital output module.

**Table 20 - Safety Digital Output Module Specifications 1734-OBV2S**

Attribute	Value
<b>Safety Output</b>	
Outputs per module	4 (2 bipolar pairs)
Output type	Current sourcing/Current sinking Bipolar pairs
Output current (each bipolar pair), max	1.25 A @ 40 °C (104 °F) 0.5 A @ 55 °C (131 °F)
1734-OBV2S Series B temperature vs. current per bipolar pair derating for both horizontal and vertical installations	
Aggregate current of bipolar pairs per module <sup>(1)</sup>	2 A @ 40 °C (104 °F) 0.8 A @ 55 °C (131 °F)
1734-OBV2S Series B temperature vs. aggregate current of bipolar pairs per module derating for both horizontal and vertical installations <sup>(1)</sup>	
Sensor power supply current rating (V and C terminals)	0.7 A max per point at 40 °C (104 °F) 0.3 A max per point at 55 °C (131 °F)
Product temperature versus sensor power current derating (per terminal)	
Pulse width	475 μs
Pulse period	575 ms
Maximum field capacitance limit permitted per output	950 nF
On-state voltage drop per bipolar pair	0.33 V
Leakage current, max	1.0 mA
Short-circuit detection	Yes (short high and low and cross-circuit detect)
Short-circuit protection	Electronic
Reaction time	<6.2 ms
<b>POINTBus</b>	
POINTBus current, max	125 mA

**Table 20 - Safety Digital Output Module Specifications 1734-OBV2S (continued)**

Attribute	Value
Power dissipation, max <sup>(2)</sup>	3.1 W
Thermal dissipation, max	10.59 BTU/hr
Power dissipation, typical <sup>(3)</sup>	2.2 W
Isolation voltage	50V (continuous), Basic Insulation Type between field side and system No isolation between individual channels Type tested at 500V AC for 60 s channel to channel.
Power bus, operating supply voltage	24V DC nom, SELV, 150 VA max
Power bus, operating voltage range	19.2...28.8V DC, SELV, 150 VA max
Power bus current (no load), max	65 mA
Indicators	1 yellow lock status indicator 1 green/yellow power status indicator 4 I/O channel status indicators
Keyswitch positions (left and right)	Key 1 = 8 (left); Key 2 = 2 (right)
Pilot duty rating	DC-13, DC-14 Inrush Electronically limited 1.8A
North America temp code	T4
ATEX temp code	T4
Enclosure type rating	None (open-style)
Wiring category <sup>(4)</sup>	2 - on signal ports
Wire size	Determined by installed terminal block
Terminal block torque	Determined by installed terminal block
Weight, approx.	62.4 g (2.2 oz)
Dimensions (HxWxD), approx. (without terminal block)	77 x 25 x 55 mm (3.03 x 0.98 x 2.17 in.)

- (1) To comply with UL certification requirements, power must be supplied from SELV compliant power supply (See [Choosing a Power Supply on page 43](#)) which limits available field power to 150 VA. Therefore, the aggregate current of outputs per module is limited to a maximum set by the 150 VA limit (unless derated further as shown) for applications that require UL listing.
- (2) Maximum power dissipation applies when using 28.8V DC module supply and maximum power dissipated with all four outputs in the ON state.
- (3) Typical power dissipation applies when using 24V DC module supply and nominal power dissipated with all four outputs in the ON state.
- (4) Use this conductor category information for planning conductor routing. See the Industrial Automation Wiring and Grounding Guidelines, publication [1770-4.1](#).

## Environmental Specifications

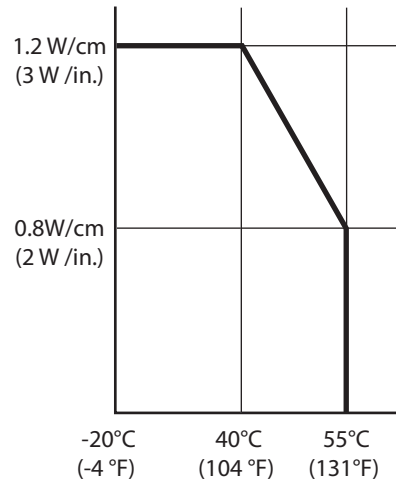
These are the environmental specifications for the 1734-IB8S, 1734-OB8S, 1734-OBV2S, and 1734-IE4S modules.

Attribute	Value
Temperature, operating	IEC 60068-2-1 (Test Ad, Operating Cold), IEC 60068-2-2 (Test Bd, Operating Dry Heat), IEC 60068-2-14 (Test Nb, Operating Thermal Shock): -20...55 °C (-4...131 °F) <sup>(1)</sup>
Temperature, nonoperating	IEC 60068-2-1 (Test Ab, Unpackaged Nonoperating Cold), IEC 60068-2-2 (Test Bb, Unpackaged Nonoperating Dry Heat), IEC 60068-2-14 (Test Na, Unpackaged Nonoperating Thermal Shock): -40...85 °C (-40...185 °F)
Temperature, surrounding air, max	55 °C (131 °F) <sup>(1)</sup>
Relative humidity	IEC 60068-2-30 (Test Db, Unpackaged Damp Heat): 5...95% noncondensing
Vibration	IEC 60068-2-6, (Test Fc, Operating) 5 g @ 10...500 Hz
Shock, operating	IEC 60068-2-27 (Test Ea, Unpackaged Shock) 30 g
Shock, nonoperating	IEC 60068-2-27 (Test Ea, Unpackaged Shock) 50 g
Corrosives	1734-IB8S and 1734-OB8S Series B only: G2 (ISA 571.04)
Emissions	IEC 61000-6-4
ESD immunity	IEC 61000-4-2: 4 kV contact discharges (1734-IB8S Series B, and 1734-OB8S, 1734-OBV2S Series B only) 6 kV contact discharges (1734-IB8S, Series A; 1734-OB8S, Series A; and 1734-IE4S) 8 kV air discharges (all modules)
Radiated RF immunity	IEC 61000-4-3: 10V/m with 1 kHz sine-wave 80% AM from 80...2000 MHz 10V/m with 200 Hz 50% Pulse 100% AM at 900 MHz 10V/m with 200 Hz 50% Pulse 100% AM at 1890 MHz 3V/m with 1 kHz sine-wave 80% AM from 2000...2700 MHz 3V/m with 1 kHz sine-wave 80% AM from 2700...6000 MHz, 1734-OBV2S
EFT/B immunity	IEC 61000-4-4: ±3 kV @ 5 kHz on power ports (1734-IE4S only) ±3 kV @ 5 kHz shielded on signal ports (1734-IE4S only) ±2 kV @ 5 kHz on signal ports (1734-IB8S, 1734-OB8S only)
Surge transient immunity	IEC 61000-4-5: ±1 kV line-line (DM) and ±2 kV line-earth (CM) on signal ports (1734-IB8S and 1734-OB8S only) ±1 kV line-line (DM) and ±2 kV line-earth (CM) on power ports (1734-IE4S only) ±2 kV line-earth (CM) on shielded ports (1734-IE4S only)
Conducted RF immunity	IEC 61000-4-6: 10V rms with 1 kHz sine-wave 80% AM from 150 kHz...80 MHz

Attribute	Value
Voltage and current ratings <b>1734-IE4S, Series A</b>	<b>Field Power:</b> 19.2...28.8V DC, 65mA, Class 2 <b>SENSOR OUTPUT:</b> 24V DC 150 mA max per output @ 55 °C (131 °F) <b>INPUT:</b> +/-10V DC Voltage 0...20 mA Current <b>TACH:</b> 0...24V DC <b>BACKPLANE:</b> 5V DC, 110mA
Voltage and current ratings <b>1734-OB8S, Series B</b>	<b>Field Power:</b> 19.2...28.8V DC, 50mA (no load), Class 2 <b>OUTPUT:</b> 19.2...28.8V DC 1.0A max per output @ 40 °C (104 °F) 500mA max per output @ 55 °C (131 °F) 8.0A max per module @ 40 °C (104 °F) 2.0A max per module @ 55 °C (131 °F) <b>BACKPLANE:</b> 5V DC, 125mA
Voltage and current ratings <b>1734-IB8S, Series B</b>	<b>Field Power:</b> 19.2...28.8V DC, 25mA (no load), Class 2 <b>OUTPUT:</b> 19.2...28.8V DC 700mA max per output @ 40 °C (104 °F) 500mA max per output @ 55 °C (131 °F) 2.8A max per module @ 40 °C (104 °F) 0.55A max per module @ 55 °C (131 °F) <b>INPUT:</b> 11...30V DC, 3.5mA @ 40 °C (104 °F), Class 2 11...28.8V DC, 3.5mA @ 55 °C (131 °F), Class 2 <b>BACKPLANE:</b> 5V DC, 110mA
Voltage and current ratings <b>1734-OBV2S, Series B</b>	<b>Field Power:</b> 19.2...28.8V DC, 65mA (no load), SELV Maximum 150VA <b>OUTPUT:</b> 19.2...28.8V DC 1.25A max per output @ 40 °C (104 °F) 500mA max per output @ 55 °C (131 °F) 2.0A max per module @ 40 °C (104 °F) 800mA max per module @ 55 °C (131 °F) <b>BACKPLANE:</b> 5V DC, 125mA

(1) See [Figure 63, System Temperature Derating When a 1734-IE4S Module Is Used](#).

Figure 63 - System Temperature Derating When a 1734-IE45 Module Is Used



See [Placing Series A Digital and Analog Modules on page 47](#) for examples.

## Certifications

POINT Guard I/O™ modules have the following certifications, when product is marked.

<b>Certification</b> (when product is marked) <sup>(1)</sup>	<b>1734-IB8S, 1734-OB8S, 1734-OBV2S, and 1734-IE4S</b>
c-UL-us	UL Listed Industrial Control Equipment, certified for US and Canada. See UL File E65584. UL Listed for Class I, Division 2, Group A,B,C,D Hazardous Locations, certified for U.S. and Canada. See UL File E194810.
CE	European Union 2014/30/EU EMC Directive, compliant with: <ul style="list-style-type: none"> <li>• EN 61326-1; Meas./Control/Lab., Industrial Requirements</li> <li>• EN 61000-6-2; Industrial Immunity</li> <li>• EN6100-6-4; Industrial Emissions</li> <li>• EN 61131-2; Programmable Controllers (Clause 8, Zone A &amp; B)</li> </ul>
EAC	1734-OB8S Series B, 1734-IB8S Series B, and 1734-IE4S Series A Russian Customs Union TR CU 020/2011 EMC Technical Regulation
Ex	European Union 2014/34/EU ATEX Directive, compliant with: <ul style="list-style-type: none"> <li>• EN 60079-0; General Requirements</li> <li>• EN 60079-15; Potentially Explosive Atmospheres, Protection 'n'</li> <li>• II 3 G Ex nA IIC T4 Gc</li> <li>• DEMK009ATEX0919970X</li> </ul>
KC	Korean Registration of Broadcasting and Communications Equipment, compliant with: Article 58-2 of Radio Waves Act, Clause 3
ODVA	ODVA conformance tested to CIP Safety on DeviceNet specifications
RCM	Australian Radiocommunications Act compliant with: EN 61000-6-4; Industrial Emissions
TÜV Functional Safety	Certified by TÜV Rheinland <sup>(2)</sup> : capable of SIL CL 3 (IEC 61508, IEC 62061) and PLe/Cat. 4 (ISO13849-1)

(1) See the Product Certification link at <http://www.ab.com> for Declaration of Conformity, Certificates, and other certification details.

(2) When used with specified Firmware Revisions.

1734-IE4S, 1734-IB8S Series B, 1734-OB8S, and 1734-OBV2S Series B modules are certified for use to help meet the following:

- NFPA 85 - Burners
- NFPA 86 - Furnaces
- NFPA 72 – Fire Alarms

1734-IE4S, 1734-IB8S, 1734-OB8S, and 1734-OBV2S are certified to help meet NFPA79 – Electrical Installation of Industrial Machinery.

1734-IE4S, 1734-IB8S Series B, and 1734-OB8S, Series B modules are certified to help meet the following: EN14459 and EN13611 (suitable for use in Group 1, Class C burner control system applications).

## Standards

Familiarize yourself with related legislation and standards information. Relevant international standards include the following:

- IEC 61508 (SIL 1...3)
- IEC 61131-6
- IEC 60204-1
- IEC 62061
- ISO 13849-1

**Notes:**



## Safety Data

This appendix lists calculated values for probability of failure on demand (PFD), probability of failure per hour (PFH), and mean time to failure (MTTF). PFD and PFH calculations comply with IEC61508, edition 2, 2010.

Calculated values of probability of failure on demand and probability of failure per hour appear in the table. Both must be calculated for the devices within the system to comply with the SIL level that is required for application.

You must be responsible for following the requirements of ISO 13849-1:2008, to assess Performance Levels in their safety system.

You must functionally test every I/O module by individually toggling each input point and also verify that the controller detects it within the safety reaction time.

Additionally, you must individually toggle each output point by the controller and user-verified that the output point changes state.

For more information, see these publications.

Resource	Description
GuardLogix® 5570 Controller Systems Safety Reference Manual, publication <a href="#">1756-RM099</a>	Provides information on safety application requirements for GuardLogix 5570 controllers in Studio 5000 Logix Designer® projects.
GuardLogix Controller Systems Safety Reference Manual, publication <a href="#">1756-RM093</a>	Provides information on safety application requirements for GuardLogix 5560 and 5570 controllers in RSLogix 5000® projects.

## Series A Safety Data

Figure 64 - PFD vs. Proof Test Interval 1734-IB8S Series A

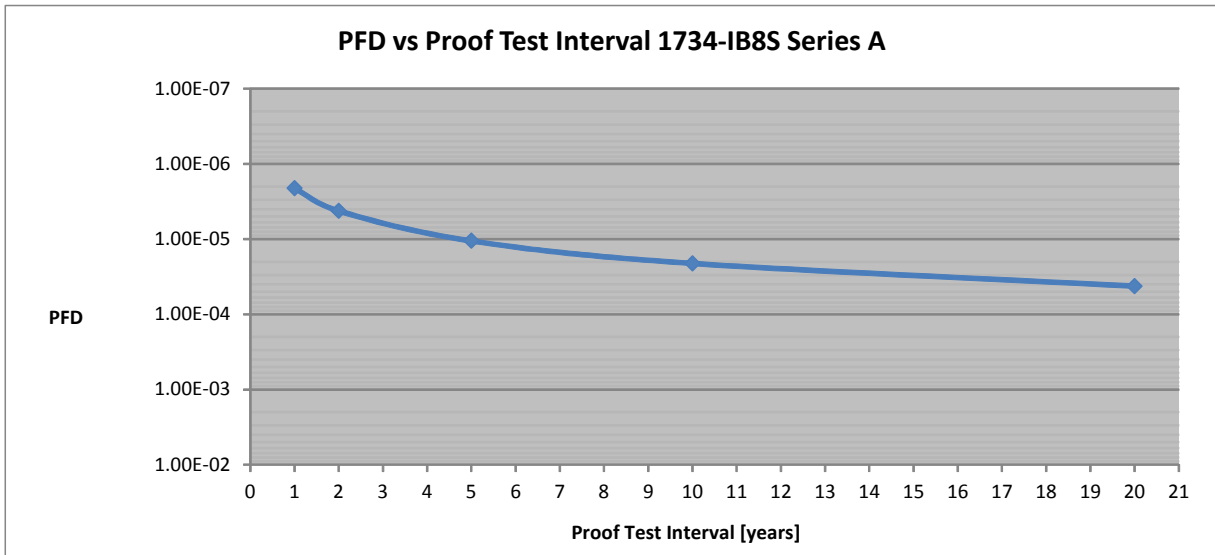
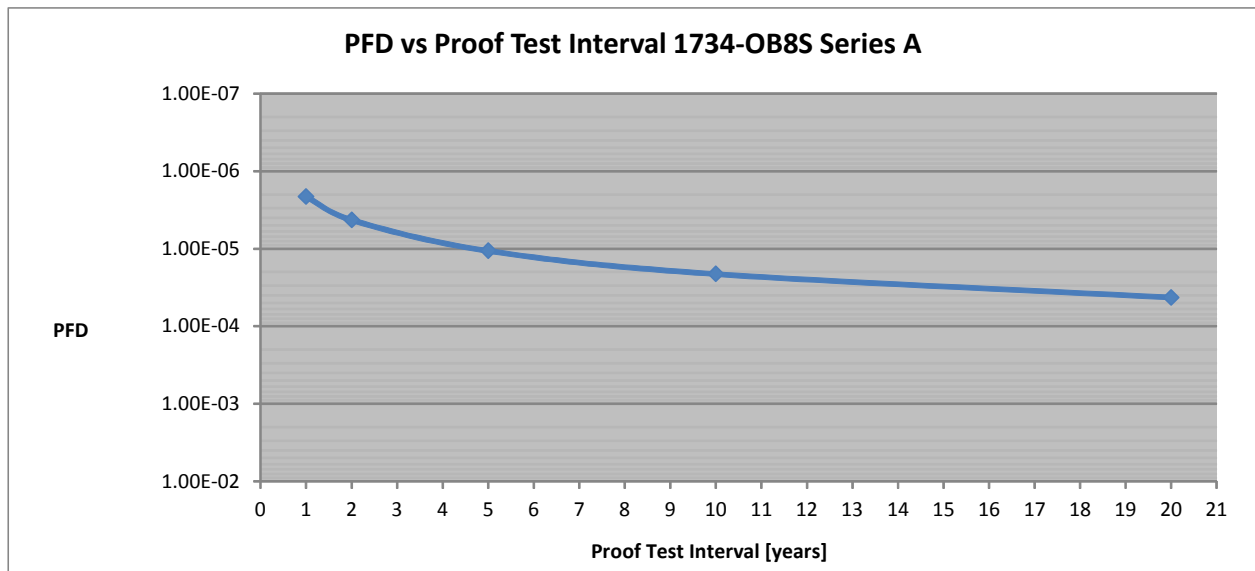
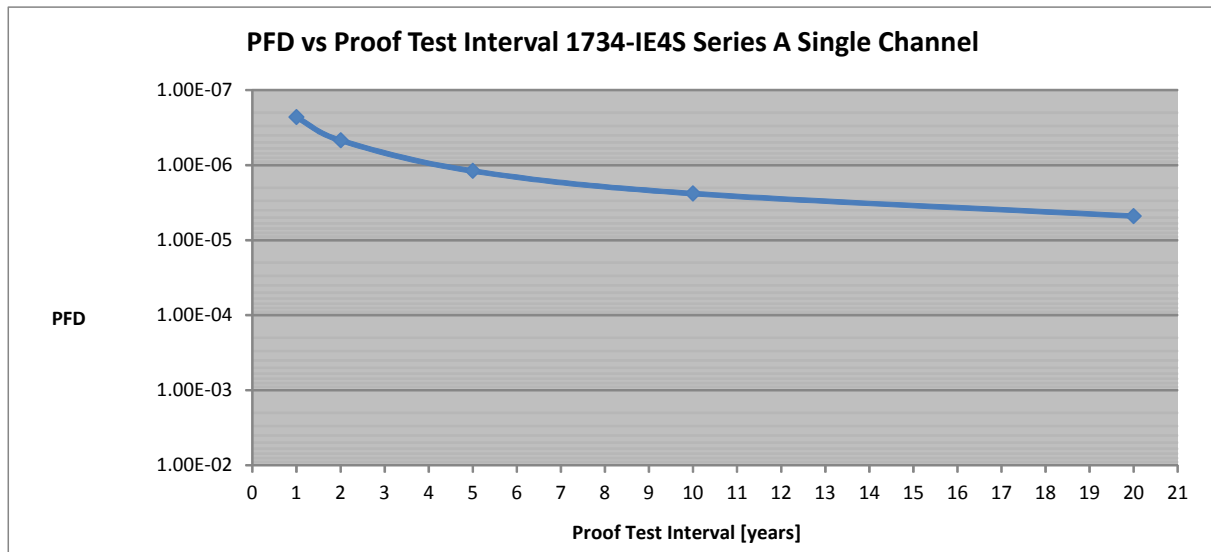


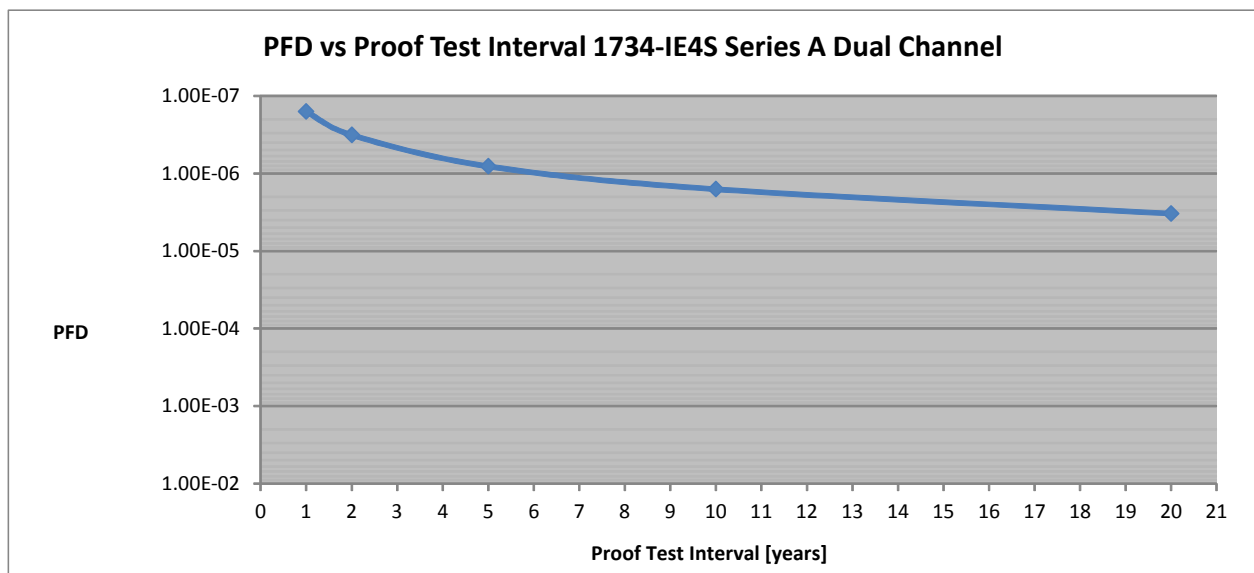
Figure 65 - PFD vs. Proof Test Interval 1734-OB8S Series A



**Figure 66 - PFD vs. Proof Test Interval 1734-IE4S Series A Single Channel**



**Figure 67 - PFD vs. Proof Test Interval 1734-IE4S Series A Dual Channel**



Cat. No.	Proof Test Interval (Mission Time)		PFD	PFH (1/hour)	Spurious Trip Rate (STR) <sup>(1)</sup>	MTTF <sub>spurious</sub> <sup>(2)</sup> (years)	
	Year	Hour					
1734-IB8S Series A	1	8760	2.11E-06	5.10E-10	2.666E-06	42.78	
	2	17520	4.23E-06				
	5	43800	1.06E-05				
	10	87600	2.11E-05				
	20	175200	4.23E-05				
1734-OB8S Series A	1	8760	2.13E-06	5.14E-10	3.229E-06	35.33	
	2	17520	4.27E-06				
	5	43800	1.07E-05				
	10	87600	2.13E-05				
	20	175200	4.27E-05				
1734-IE4S Series A Single Channel	1	8760	2.30E-07	5.30E-11	9.402E-07	121.42	
	2	17520	4.70E-07				
	5	43800	1.20E-06	5.40E-11			
	10	87600	2.40E-06	5.50E-11			
	20	175200	4.80E-06	5.60E-11			
1734-IE4S Series A Dual Channel	1	8760	1.60E-07	3.70E-11	9.402E-07	121.42	
	2	17520	3.20E-07				
	5	43800	8.10E-07				
	10	87600	1.60E-06				3.80E-11
	20	175200	3.30E-06				3.90E-11

(1) Calculated based on ISA TR-84 method.

(2) Mean time to failure (Spurious).

Mission Time for all modules is 20 years.

All 1734-IB8S safety input channels and all 1734-OB8S safety output channels must utilize pulse testing when used in Functional Safety applications.

## Series B Safety Data

Figure 68 - PFD vs. Proof Test Interval 1734-IB8S Series B Single Channel

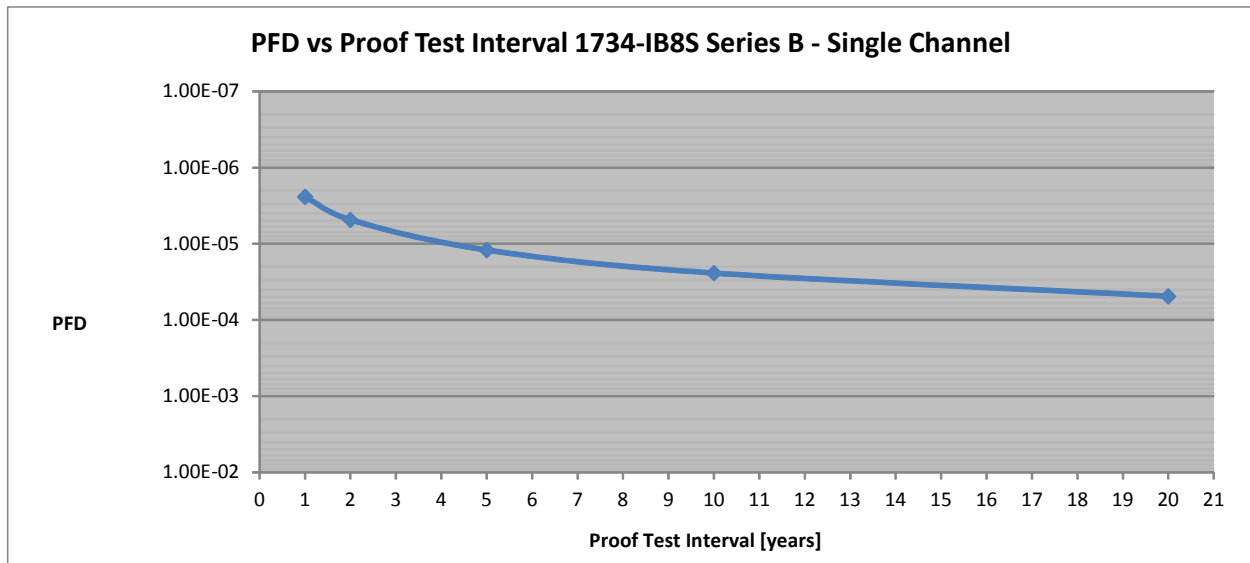
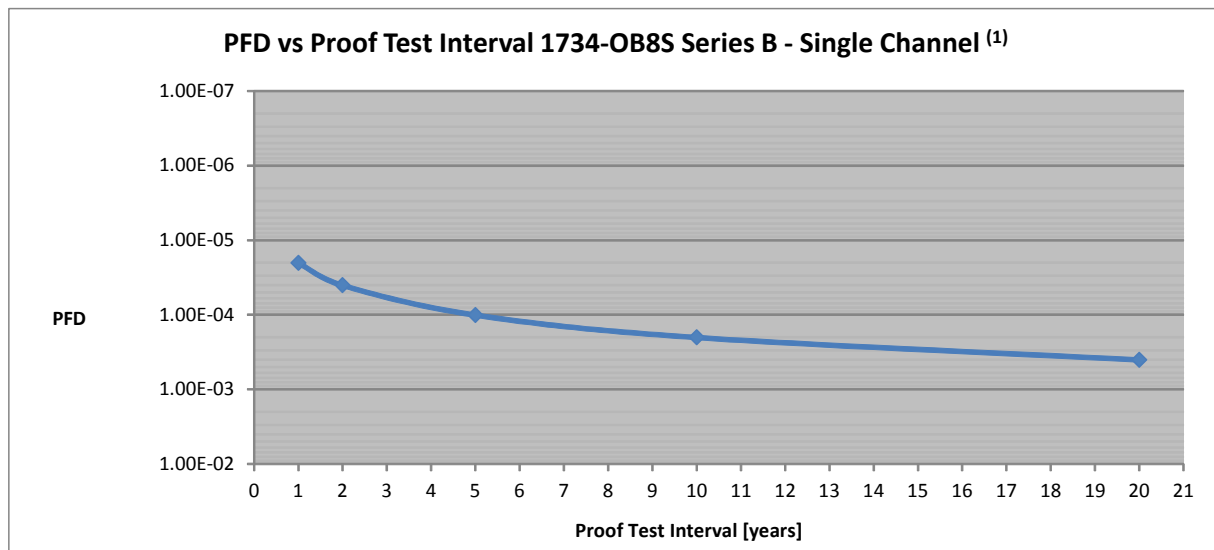


Figure 69 - PFD vs. Proof Test Interval 1734-OB8S Series B Single Channel<sup>(1)</sup>



(1) 1734-OB8S single channel mode is only certified for functional safety applications with Process Safety Times  $\geq$  600 msec OR with Demand Rates  $\leq$  1 Demand per Minute.

Figure 70 - PFD vs. Proof Test Interval 1734-IB8S Series B Dual Channel

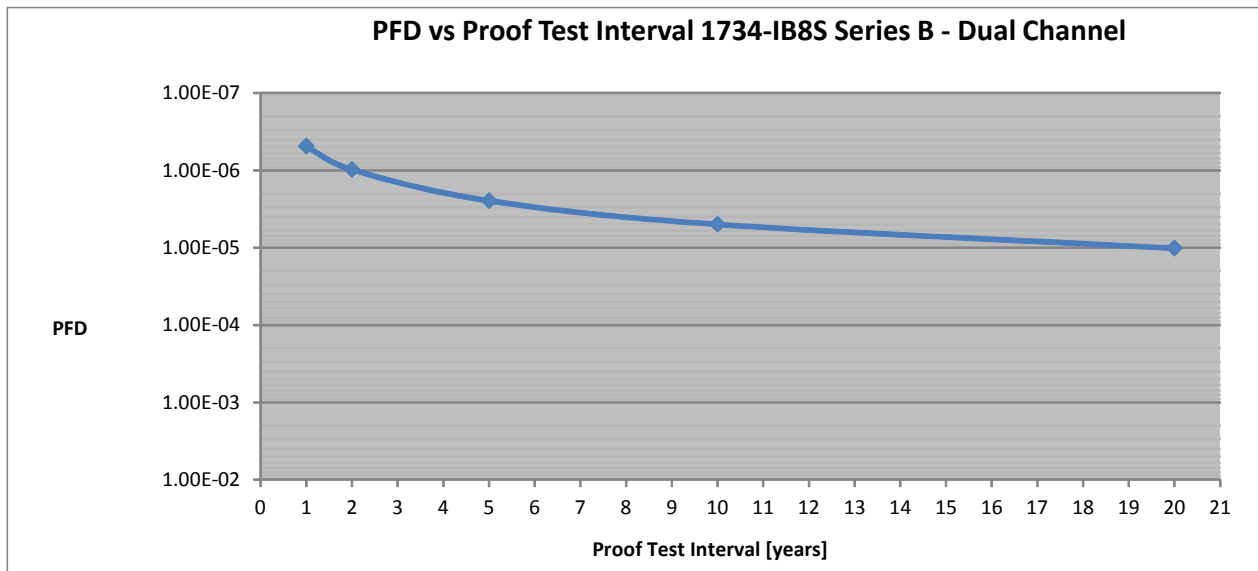
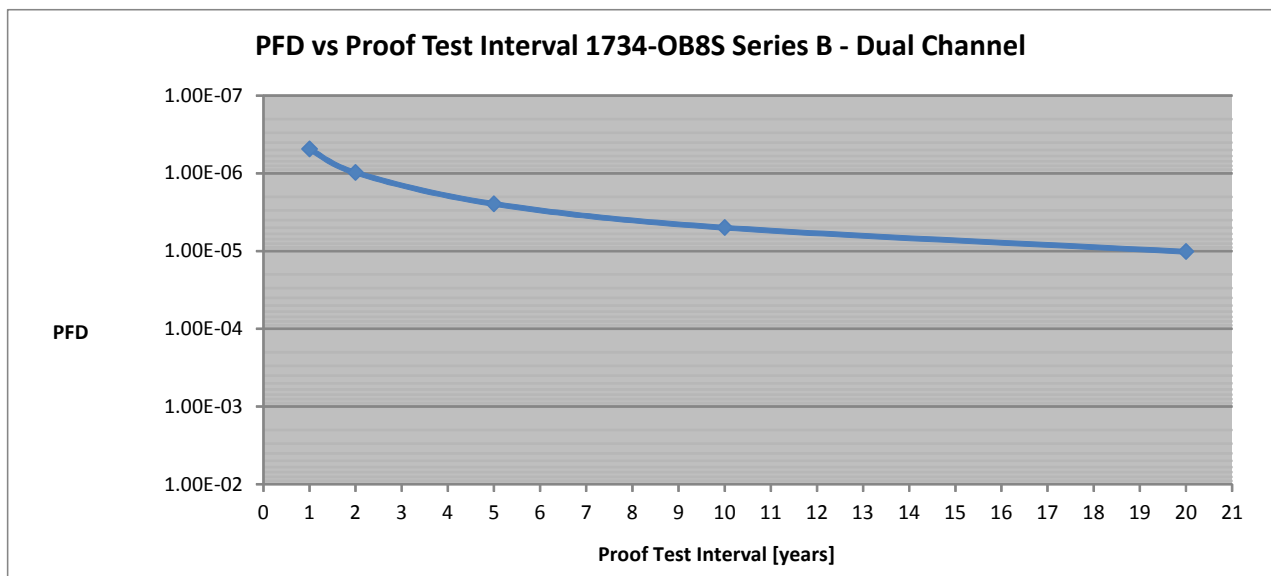
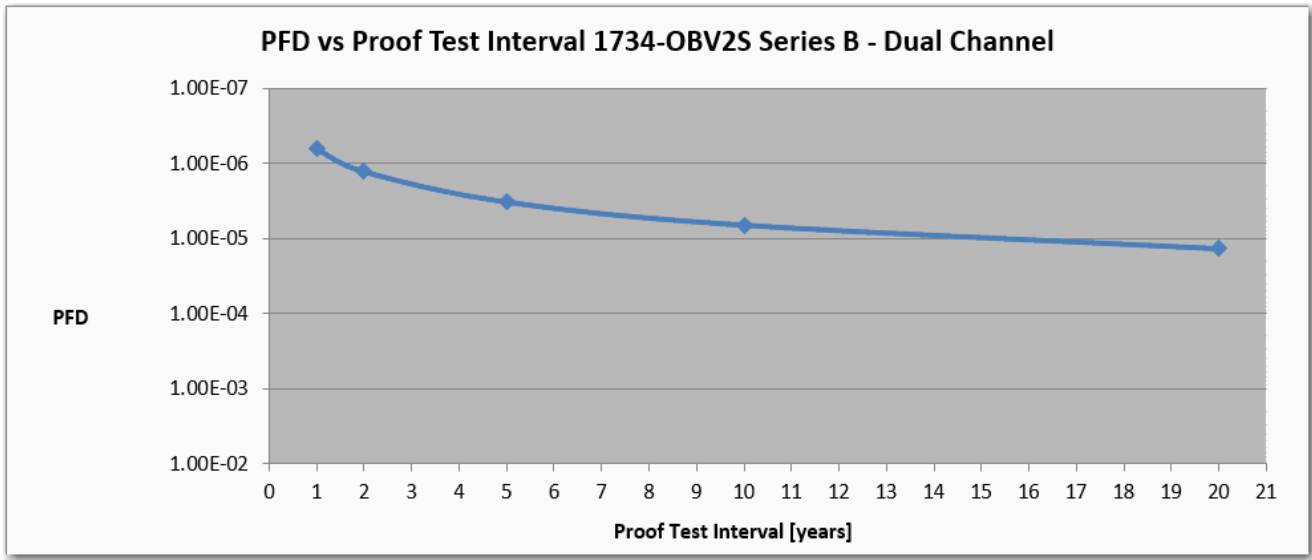


Figure 71 - PFD vs. Proof Test Interval 1734-OB8S Series B Dual Channel



**Figure 72 - PFD vs. Proof Test Interval 1734-OBV2S Series B Dual Channel**



Catalog Number	Proof Test Interval (Mission Time)		PFD	PFH (1/hour)	Spurious Trip Rate (STR) <sup>(2)</sup>	MTTF spurious (years) <sup>(3)</sup>
	Year	Hour				
1734-IB8S Series B Single Channel	1	8760	2.42E-06	5.61E-10	2.709E-06	42.14
	2	17520	4.85E-06			
	5	43800	1.21E-05			
	10	87600	2.43E-05			
	20	175200	4.89E-05			
1734-OB8S Series B <sup>(1)</sup> Single Channel	1	8760	2.02E-05	4.62E-09	3.243E-06	35.20
	2	17520	4.04E-05			
	5	43800	1.01E-04			
	10	87600	2.02E-04			
	20	175200	4.04E-04			
1734-IB8S Series B Dual Channel	1	8760	4.89E-07	1.20E-10	2.709E-06	42.14
	2	17520	9.80E-07			
	5	43800	2.47E-06			
	10	87600	5.00E-06			
	20	175200	1.02E-05			
1734-OB8S Series B Dual Channel	1	8760	4.89E-07	1.20E-10	3.243E-06	35.20
	2	17520	9.81E-07			
	5	43800	2.47E-06			
	10	87600	5.00E-06			
	20	175200	1.02E-05			
1734-OBV2S Series B Dual Channel	1	8760	6.45E-07	1.64E-10	2.969E-06	38.45
	2	17520	1.29E-06			
	5	43800	3.26E-06			
	10	87600	6.63E-06			
	20	175200	1.37E-05			

(1) 1734-OB8S single channel mode is only certified for functional safety applications with process safety times ≥ 600 ms or with demand rates ≤ 1 demand per minute.

(2) Calculated based on ISA TR-84 method.

(3) Mean time to failure (spurious).

Mission Time for all modules is 20 years.

All 1734-IB8S safety input channels, all 1734-OB8S safety output channels, and all 1734-OBV2S safety output channels must utilize pulse testing when used in Functional Safety applications.



## Product Failure Rates (failures per hour)

**Table 21 - Product Failure Rates (failures per hour)<sup>(1)</sup>**

Catalog Number	Series	Module I/O Configuration	$\lambda_S$	$\lambda_{DD}$	$\lambda_{DU}$
1734-IB8S	B	Single Channel Inputs	2.56E-07	2.55E-07	6.02E-10
1734-OB8S	B	Single Channel Outputs <sup>(2)</sup>	2.52E-07 <sup>(2)</sup>	2.52E-07 <sup>(2)</sup>	4.47E-09 <sup>(2)</sup>
1734-IE4S	A	Single Channel Inputs	4.23E-07	4.23E-07	1.01E-10
1734-IB8S	B	Dual Channel Inputs	2.96E-07	2.94E-07	1.84E-10
1734-OB8S	B	Dual Channel Outputs	2.95E-07	2.95E-07	1.84E-10
1734-OBV2S	B	Dual Channel Outputs	4.08E-07	4.08E-07	2.41E-10
1734-IE4S	A	Dual Channel Inputs	6.56E-07	6.56E-07	6.67E-11

(1) These failure rates assume that the module is represented by one block in a reliability block diagram. The single channel rates must be applied to the reliability block if the module is configured in Single Channel mode. The dual channel rates must be applied to the reliability block if the module is configured in Dual Channel mode.

(2) 1734-OB8S single channel mode is only certified for functional safety applications with Process Safety Times  $\geq$  600 msec or with Demand Rates  $\leq$  1 Demand per Minute.

All 1734-IB8S safety input channels, all 1734-OB8S safety output channels, and all 1734-OBV2S safety output channels must utilize pulse testing when used in single channel functional safety applications

**Notes:**

## Configuration Parameters

Topic	Page
Table 22 Safety Digital Input Parameters	207
Table 23 Test Output Parameters	208
Table 24 Safety Digital Output Parameters	208
Table 25 Safety Analog Input Parameters	208

This appendix lists parameters that can be configured via the Logix Designer application.

**Table 22 - Safety Digital Input Parameters**

Parameter Name <sup>(1)</sup>	Value	Description	Default
x Input Delay Time Off -> On	0 ... 126 ms (in increments of 6 ms)	Filter time for OFF to ON transition.	
x Input Delay Time On -> Off	0 ... 126 ms (in increments of 6 ms)	Filter time for ON to OFF transition.	
x Input Point Mode	Not Used	External input device is not connected.	
	Safety Pulse Test	Use with a contact output device and in combination with a test output. With the use of this setting, short-circuits between input signal lines and the power supply (positive side) and short-circuits between input signal lines can be detected.	
	Safety	A solid-state output safety sensor is connected.	
	Standard	A standard device, such as a reset switch, is connected.	
x Safety Input Test Source	Not Used	The test output that is used with the input.	
	Test Output 0		
	Test Output 1		
	Test Output 2		
	Test Output 3		
x Input Point Operation Type	Single Channel	Use as single channel.	
	Dual-channel Equivalent	Use as dual-channel. Normal when both channels are ON or OFF.	
	Dual-channel Complementary	Use as dual-channel. Normal when one channel is ON and the other channel is OFF.	
x Safety Input Error Latch Time	0 ... 65,530 ms (in increments of 10 ms)	Safety input or test output errors are latched for this time.	1000 ms

(1) Parameters that are directly related to safety are marked with an x in the left column.

**Table 23 - Test Output Parameters**

Parameter Name <sup>(1)</sup>		Value	Description	Default
x	Test Output Mode	Not Used	An external device is not connected.	Not Used
		Standard	The output is connected to a standard device.	
		Pulse Test	A contact output device is connected. Use in combination with a safety input.	
		Power Supply	The power supply of a Safety Sensor is connected. The voltage that is supplied to I/O power (V, G) is output from the test output terminal.	
		Muting Lamp Output (Terminal T1 or T3 only)	An indicator is connected and turned ON to detect broken lines in an external indicator.	
	Test Output Fault Action	Clear OFF	Action to perform when a communication error is detected.	Clear OFF
		Hold Last Data		

(1) Parameters that are directly related to safety are marked with an x in the left column.

**Table 24 - Safety Digital Output Parameters**

Parameter Name <sup>(1)</sup>		Value	Description	Default
x	Output Point Mode	Not Used	An external output device is not connected.	Not Used
		Safety	When the output is ON, the test pulse is not output (remains ON).	
		Safety Pulse Test	With use of this function, short-circuits between output signal lines and the power supply (positive side) and short-circuits between output signal lines can be detected.	
x	Output Point Operation Type	Single Channel	Use as single channel.	Dual-channel
		Dual-channel	Use as dual-channel. When both channels are normal, outputs can be turned ON.	
x	Safety Output Error Latch Time	0...65,530 ms (in increments of 10 ms)	Safety output errors are latched for this time.	1000 ms

(1) Parameters that are directly related to safety are marked with an x in the left column.

Parameter Name	Value	Description	Default
Test Output Idle State <sup>(1)</sup>	Clear OFF or Keep Output Data	Definition of output data is in idle state.	Clear OFF

(1) Set **only** through Explicit Messaging. See for [Appendix B](#) more information.

**Table 25 - Safety Analog Input Parameters**

Parameter Name <sup>(1)</sup>		Value	Description	Default
x	Input Point Mode	Not Used	External input device is not connected.	Not Used
		Safety	A solid-state safety sensor is connected.	
		Standard	A device that is not used in the safety loop is connected.	
	Range	±10V	Input voltage range.	4...20 mA
		0...5V		
		0...10V		
		±5V	Input current range.	
		4...20 mA		
		0...20 mA		
		Tachometer		

**Table 25 - Safety Analog Input Parameters (continued)**

Parameter Name <sup>(1)</sup>	Value	Description	Default	
x	Input Point Operation Type	Single channel	Single	
		Dual channel		Use as a dual channel equivalent. This setting must be used only with SmartGuard™ controllers.
	Filter	1 Hz	Input filter	
		5 Hz		
		10 Hz		
		50 Hz		
1 Hz				
x	Safety Input Error Latch Time	0...65,530 ms (in 10 ms increments)	Safety input errors are latched for this time so that the controller can them and they are not missed if they clear themselves too quickly. One value for all channels.	1000
	Low Engineering	-30000...30000	Scaling value for inputs	0
	High Engineering	-30000...30000	Scaling value for inputs	10,000 <sup>(2)</sup>
x	Tachometer Dual Low Diagnostic	ON/OFF	Diagnostic that indicates if both channels are low. Channels 0 and 1 share value and channels 2 and 3 share value.	Off
	Tachometer Trigger	Falling edge (NPN)	Non-inverted input signal.	Falling edge
		Rising edge (PNP)	Inverted input signal.	
	Tachometer Off Level	0...23V (in 1 V increments)	Off-level for the Tachometer mode input signal.	5V
	Tachometer On Level	1...24V (in 1V increments)	On-level for the Tachometer mode input signal.	11V
x	Sensor Power Mode	External	Sensors are getting their power from a separate power supply.	Module
		Module	Sensors are getting their power from the module (recommended).	
	Alarm Enable	Disable	Enable or disable alarms. We recommend disabling this feature when using the module in a GuardLogix® system (evaluate alarms with the use of the application program). Enable this feature when using the module in a SmartGuard system.	Disable
		Enable		
	High High Alarm Level	-32768...32767	High High alarm trip point.	32767
	Low Low Alarm Level	-32768...32767	Low Low alarm trip point.	-32767
	High High - Low Low deadband	0...32767	Deadband on the High High and Low Low alarms.	0
	High Alarm	-32768...32767	High alarm trip point.	332767
	Low Alarm	-32768...32767	Low alarm trip point.	0
	High - Low deadband	0...32767	Deadband on the High and Low alarms.	0
x	Discrepancy Time	0...65,530 (in 10 ms increments)	Time period during which the channel values can be discrepant before an error is reported.	100 ms
x	Discrepancy deadband	0...32767	Tolerance range between channels in dual-channel mode (in engineering units)	0
x	Channel Offset	-32768...32767	Offset value for dual channel mode only (in engineering units).	0

(1) Parameters that are directly related to safety are marked with an x in the left column.

(2) 1000 for Tachometer mode.

**Notes:**

## I/O Assemblies

Topic	Page
Input Assemblies	211
Output Assemblies	212
Analog Input Assemblies	212
Configuration Assemblies	215
Using Data from Modules Configured Via the Generic Profile	221

### Input Assemblies

Table 26 - 1734-IB8S Input Assemblies

Instance Decimal (hex)	Connection Type	Byte	Bit 7	Bit 6	Bit 5	Bit 4	Bit 3	Bit 2	Bit 1	Bit 0
516 (204 h)	Safety and Standard	0	Safety Input 7	Safety Input 6	Safety Input 5	Safety Input 4	Safety Input 3	Safety Input 2	Safety Input 1	Safety Input 0
548 (224 h)	Safety Only	0	Safety Input 7	Safety Input 6	Safety Input 5	Safety Input 4	Safety Input 3	Safety Input 2	Safety Input 1	Safety Input 0
		1	Safety Input 7 Status	Safety Input 6 Status	Safety Input 5 Status	Safety Input 4 Status	Safety Input 3 Status	Safety Input 2 Status	Safety Input 1 Status	Safety Input 0 Status
768 (300 h)	Standard Only	0	Reserved							Input Power Error
788 (314 h)	Safety and Standard	0	Safety Input 7	Safety Input 6	Safety Input 5	Safety Input 4	Safety Input 3	Safety Input 2	Safety Input 1	Safety Input 0
		1	Combined Safety Input Status	Reserved	Input Power Error <sup>(1)</sup>	Reserved	Reserved	Reserved	Muting Lamp 3 Status	Muting Lamp 1 Status
820 (334 h)	Safety and Standard	0	Safety Input 7	Safety Input 6	Safety Input 5	Safety Input 4	Safety Input 3	Safety Input 2	Safety Input 1	Safety Input 0
		1	Safety Input 7 Status	Safety Input 6 Status	Safety Input 5 Status	Safety Input 4 Status	Safety Input 3 Status	Safety Input 2 Status	Safety Input 1 Status	Safety Input 0 Status
		2	Reserved		Input Power Error <sup>(1)</sup>	Reserved			Muting Lamp 3 Status	Muting Lamp 1 Status
868 (364 h)	Safety and Standard	0	Safety Input 7	Safety Input 6	Safety Input 5	Safety Input 4	Safety Input 3	Safety Input 2	Safety Input 1	Safety Input 0
		1	Safety Input 7 Status	Safety Input 6 Status	Safety Input 5 Status	Safety Input 4 Status	Safety Input 3 Status	Safety Input 2 Status	Safety Input 1 Status	Safety Input 0 Status
		2	Reserved				Test Output 3 Status	Test Output 2 Status	Test Output 1 Status	Test Output 0 Status
		3	Reserved		Input Power Error <sup>(1)</sup>	Reserved			Muting Lamp 3 Status	Muting Lamp 1 Status
899 (383 h)	Standard	0	Reserved							Input Power Error
		1	Reserved				Test Output 3 Status	Test Output 2 Status	Test Output 1 Status	Test Output 0 Status

(1) This data is diagnostic only and does **not** have safety integrity.

**Table 27 - 1734-OB8S Input Assemblies**

Instance Decimal (hex)	Connection Type	Byte	Bit 7	Bit 6	Bit 5	Bit 4	Bit 3	Bit 2	Bit 1	Bit 0
580 (244 h)	Safety and Standard	0	Safety Output 7 Status	Safety Output 6 Status	Safety Output 5 Status	Safety Output 4 Status	Safety Output 3 Status	Safety Output 2 Status	Safety Output 1 Status	Safety Output 0 Status
1028 (404 h)	Safety and Standard	0	Safety Output 7 Status	Safety Output 6 Status	Safety Output 5 Status	Safety Output 4 Status	Safety Output 3 Status	Safety Output 2 Status	Safety Output 1 Status	Safety Output 0 Status
		1	Safety Output Monitor 7	Safety Output Monitor 6	Safety Output Monitor 5	Safety Output Monitor 4	Safety Output Monitor 3	Safety Output Monitor 2	Safety Output Monitor 1	Safety Output Monitor 0
1044 (414 h)	Safety and Standard	0	Safety Output Monitor 7	Safety Output Monitor 6	Safety Output Monitor 5	Safety Output Monitor 4	Safety Output Monitor 3	Safety Output Monitor 2	Safety Output Monitor 1	Safety Output Monitor 0
		1	Reserved	Combined Output Status	Reserved	Output Power Error <sup>(1)</sup>	Reserved			

(1) This data is diagnostic only and does **not** have safety integrity.

**Table 28 - 1734-OBV2S Input Assemblies**

Instance Decimal (hex)	Connection Type	Byte	Bit 7	Bit 6	Bit 5	Bit 4	Bit 3	Bit 2	Bit 1	Bit 0
579 (243 h)	Safety	0	Reserved	Reserved	Reserved	Reserved	Safety Output 3 Status	Safety Output 2 Status	Safety Output 1 Status	Safety Output 0 Status
1027 (403 h)	Safety and Standard	0	Safety Output 3 Readback	Safety Output 2 Readback	Safety Output 1 Readback	Safety Output 0 Readback	Safety Output 3 Status	Safety Output 2 Status	Safety Output 1 Status	Safety Output 0 Status
1043 (413 h)	Safety and Standard	0	Reserved	Reserved	Reserved	Reserved	Safety Output 3 Readback	Safety Output 2 Readback	Safety Output 1 Readback	Safety Output 0 Readback
		1	Reserved	Combined Output Status	Reserved	Output Power Error <sup>(1)</sup>	Reserved			

(1) This data is diagnostic only and does **not** have safety integrity.



## Output Assemblies

**Table 29 - Output Assemblies for all POINT Guard I/O™ Modules**

Instance Decimal (hex)	Module	Connection Type	Byte	Bit 7	Bit 6	Bit 5	Bit 4	Bit 3	Bit 2	Bit 1	Bit 0
33 (21 h)	1734-IB8S	Safety <sup>(1)</sup>	0	Reserved				Standard Output 3	Standard Output 2	Standard Output 1	Standard Output 0
564 (234 h)	1734-OB8S	Safety Only	0	Safety Output 7	Safety Output 6	Safety Output 5	Safety Output 4	Safety Output 3	Safety Output 2	Safety Output 1	Safety Output 0
563 (233 h)	1734-OBV2S	Safety Only	0	Reserved	Reserved	Reserved	Reserved	Safety Output 3	Safety Output 2	Safety Output 1	Safety Output 0
770 (302 h)	1734-IE4S	Safety	0	Reserved	Reserved	Reserved	Reserved	Reset Tach <sub>3</sub> <sup>(2)</sup>	Reset Tach <sub>2</sub> <sup>(2)</sup>	Reset Tach <sub>1</sub> <sup>(2)</sup>	Reset Tach <sub>0</sub> <sup>(2)</sup>

(1) Only outputs 1 and 3 are configurable to Muting or Test Outputs. This assembly is accessible only over a Safety connection.

(2) When set (1), this bit specifies a reset of an overfrequency condition on the tachometer counter. Clear this bit to allow the tachometer channel to operate.

## Analog Input Assemblies

**Table 30 - 1734-IE4S Input Assemblies**

Instance Decimal (hex)	Connection Type	Byte	High Byte				Low Byte					
402 (192 h)	Safety and Standard	0, 1	Input 0				Input 0					
		2, 3	Input 1				Input 1					
		4, 5	Input 2				Input 2					
		6, 7	Input 3				Input 3					
			<b>Bit 7</b>	<b>Bit 6</b>	<b>Bit 5</b>	<b>Bit 4</b>	<b>Bit 3</b>	<b>Bit 2</b>	<b>Bit 1</b>	<b>Bit 0</b>		
		8	Reserved	Reserved	Reserved	Reserved	Ch 3 Input Status	Ch 2 Input Status	Ch 1 Input Status	Ch 0 Input Status		
786 (312 h)	Safety and Standard	0, 1	Input 0				Input 0					
		2, 3	Input 1				Input 1					
		4, 5	Input 2				Input 2					
		6, 7	Input 3				Input 3					
			<b>Bit 7</b>	<b>Bit 6</b>	<b>Bit 5</b>	<b>Bit 4</b>	<b>Bit 3</b>	<b>Bit 2</b>	<b>Bit 1</b>	<b>Bit 0</b>		
		8	Reserved	Reserved	Reserved	Reserved	Ch 3 Input Status	Ch 2 Input Status	Ch 1 Input Status	Ch 0 Input Status		
		9	Reserved	Tachometer Dual Low	Tachometer Underfrequency	Tachometer Overfrequency	Low Alarm Status	High Alarm Status	Low Low Alarm Status	High High Alarm Status		
		10	Reserved	Tachometer Dual Low	Tachometer Underfrequency	Tachometer Overfrequency	Low Alarm Status	High Alarm Status	Low Low Alarm Status	High High Alarm Status		
		11	Reserved	Tachometer Dual Low	Tachometer Underfrequency	Tachometer Overfrequency	Low Alarm Status	High Alarm Status	Low Low Alarm Status	High High Alarm Status		
		12	Reserved	Tachometer Dual Low	Tachometer Underfrequency	Tachometer Overfrequency	Low Alarm Status	High Alarm Status	Low Low Alarm Status	High High Alarm Status		
		<b>Instance Decimal (hex)</b>	<b>Connection Type</b>	<b>Byte</b>	<b>High Byte</b>				<b>Low Byte</b>			

**Table 30 - 1734-IE4S Input Assemblies (continued)**

802 (322 h)	Safety and Standard	0, 1	Input 0				Input 0				
		2, 3	Input 1				Input 1				
		4, 5	Input 2				Input 2				
		6, 7	Input 3				Input 3				
			<b>Bit 7</b>	<b>Bit 6</b>	<b>Bit 5</b>	<b>Bit 4</b>	<b>Bit 3</b>	<b>Bit 2</b>	<b>Bit 1</b>	<b>Bit 0</b>	
		8	Ch 3 Combined Alarm Status	Ch 2 Combined Alarm Status	Ch 1 Combined Alarm Status	Ch 0 Combined Alarm Status	Ch 3 Input Status	Ch 2 Input Status	Ch 1 Input Status	Ch 0 Input Status	
		9	Fault Reason 0								
		10	Fault Reason 1								
		11	Fault Reason 2								
		12	Fault Reason 3								
			Alarms 0 <sup>(1)</sup>								
		13	Reserved	Tachometer Dual Low	Tachometer Underfrequency	Tachometer Overfrequency	Low Alarm Status	High Alarm Status	Low Low Alarm Status	High High Alarm Status	
			Alarms 1 <sup>(1)</sup>								
		14	Reserved	Tachometer Dual Low	Tachometer Underfrequency	Tachometer Overfrequency	Low Alarm Status	High Alarm Status	Low Low Alarm Status	High High Alarm Status	
			Alarms 2 <sup>(1)</sup>								
		15	Reserved	Tachometer Dual Low	Tachometer Underfrequency	Tachometer Overfrequency	Low Alarm Status	High Alarm Status	Low Low Alarm Status	High High Alarm Status	
			Alarms 3 <sup>(1)</sup>								
16	Reserved	Tachometer Dual Low	Tachometer Underfrequency	Tachometer Overfrequency	Low Alarm Status	High Alarm Status	Low Low Alarm Status	High High Alarm Status			
17	Reserved	Reserved	Reserved	Reserved	Reserved	Reserved	Reserved	Reserved	Input Power		
<b>Instance Decimal (hex)</b>	<b>Connection Type</b>	<b>Byte</b>	<b>Bit 7</b>	<b>Bit 6</b>	<b>Bit 5</b>	<b>Bit 4</b>	<b>Bit 3</b>	<b>Bit 2</b>	<b>Bit 1</b>	<b>Bit 0</b>	
930 (3A2h)	Safety and Standard	0	Ch 3 Combined Alarm Status	Ch 2 Combined Alarm Status	Ch 1 Combined Alarm Status	Ch 0 Combined Alarm Status	Ch 3 Input Status	Ch 2 Input Status	Ch 1 Input Status	Ch 0 Input Status	
<b>Instance Decimal (hex)</b>	<b>Connection Type</b>	<b>Byte</b>	<b>Bit 7</b>	<b>Bit 6</b>	<b>Bit 5</b>	<b>Bit 4</b>	<b>Bit 3</b>	<b>Bit 2</b>	<b>Bit 1</b>	<b>Bit 0</b>	
946 (3B2h)	Safety and Standard	0	Ch 3 Combined Alarm Status	Ch 2 Combined Alarm Status	Ch 1 Combined Alarm Status	Ch 0 Combined Alarm Status	Ch 3 Input Status	Ch 2 Input Status	Ch 1 Input Status	Ch 0 Input Status	
			Alarms 0 <sup>(1)</sup>								
		1	Reserved	Tachometer Dual Low	Tachometer Underfrequency	Tachometer Overfrequency	Low Alarm Status	High Alarm Status	Low Low Alarm Status	High High Alarm Status	
			Alarms 1 <sup>(1)</sup>								
		2	Reserved	Tachometer Dual Low	Tachometer Underrange	Tachometer Overrange	Low Alarm Status	High Alarm Status	Low Low Alarm Status	High High Alarm Status	
			Alarms 2 <sup>(1)</sup>								
3	Reserved	Tachometer Dual Low	Tachometer Underrange	Tachometer Overrange	Low Alarm Status	High Alarm Status	Low Low Alarm Status	High High Alarm Status			
	Alarms 3 <sup>(1)</sup>										
4	Reserved	Tachometer Dual Low	Tachometer Underrange	Tachometer Overrange	Low Alarm Status	High Alarm Status	Low Low Alarm Status	High High Alarm Status			
5	Reserved	Reserved	Reserved	Reserved	Reserved	Reserved	Reserved	Reserved	Input Power <sup>(1)</sup>		

(1) 0 = fault; 1 = within range.

**Configuration Assemblies**

See the appropriate table for 1734-IB8S, 1734-OB8S, and 1734-IE4S configuration assembly data.

**Table 31 - Configuration Assemblies for 1734-OB8S Output Modules**

Instance Decimal (hex)	Byte	Field	Class (hex)	Instance (decimal)	Attribute (decimal)
864 (360 h)	0	Safety Output Latch Error Time (low byte)	3B	0	8
	1	Safety Output Latch Error Time (high byte)			
	2	Safety Output 0 Channel Mode	3B	1	6
	3	Safety Output 1 Channel Mode		2	
	4	Safety Output 2 Channel Mode		3	
	5	Safety Output 3 Channel Mode		4	
	6	Safety Output 4 Channel Mode		5	
	7	Safety Output 5 Channel Mode		6	
	8	Safety Output 6 Channel Mode		7	
	9	Safety Output 7 Channel Mode		8	
	10	Dual-channel Safety Output 0 Mode	3F	1	3
	11	Dual-channel Safety Output 1 Mode		2	
	12	Dual-channel Safety Output 2 Mode		3	
13	Dual-channel Safety Output 3 Mode	4			

**Table 32 - Configuration Assemblies for 1734-OBV2S Bipolar Modules**

Instance Decimal (hex)	Byte	Field	Class (hex)	Instance (decimal)	Attribute (decimal)		
864 (360 h)	0	Safety Output Latch Error Time (low byte)	3B	0	8		
	1	Safety Output Latch Error Time (high byte)					
	2	Safety Output 0 Channel Mode				1	6
	3	Safety Output 1 Channel Mode				2	
	4	Safety Output 2 Channel Mode				3	
	5	Safety Output 3 Channel Mode	4				
	6	Dual Channel Safety Out0 Mode	3F	1	3		
7	Dual Channel Safety Out1 Mode	2					

**Table 33 - Configuration Assemblies for 1734-IB8S Input Modules**

Instance Decimal (hex)	Byte	Field	Class (hex)	Instance (decimal)	Attribute (decimal)				
864 (360 h)	0	Test Output 0 Mode	9	1	13				
	1	Test Output 1 Mode		2					
	2	Test Output 2 Mode		3					
	3	Test Output 3 Mode		4					
	4	Safety Input Latch Error Time (low byte)	3D	0	8				
	5	Safety Input Latch Error Time (high byte)		1	5	6			
	6	Safety Input 0 Off_On_Delay (low byte)							
	7	Safety Input 1 Off_On_Delay (high byte)							
	8	Safety Input 0 On_Off_Delay (low byte)							
	9	Safety Input 0 On_Off_Delay (high byte)							
	10	Safety Input 0 Channel Mode					8		
	11	Safety Input 0 Test Source					9		
	...	Safety Input 1...6 Configuration Data					...	...	
	48	Safety Input 7 Off_On_Delay (low byte)					8	5	6
	49	Safety Input 7 Off_On_Delay (high byte)							
	50	Safety Input On_Off_Delay (low byte)							
	51	Safety Input On_Off_Delay (high byte)							
	52	Safety Input 7 Channel Mode		8					
	53	Safety Input 7 Test Source		9					
	54	Dual-channel Safety Input 0 Mode		348	1	3			
	55	Pad Byte (0x00)	...	...	...				
	56	Dual-channel Safety Input 0 Discrepancy Time (low byte)	348	1	5				
	57	Dual-channel Safety Input 0 Discrepancy Time (high byte)							
	...	Dual-channel Safety Input 1...2 Configuration	...	...	...				
	66	Dual-channel Safety Input 3 Mode	348	4	3				
	67	Pad Byte (0x00)	...	...	...				
	68	Dual-channel Safety Input 3 Discrepancy Time (low byte)	348	4	5				
	69	Dual-channel Safety Input 3 Discrepancy Time (high byte)							

**Table 34 - Configuration Assemblies for 1734-IE4S Input Modules**

Instance Decimal (hex)	Byte	Field	Class (hex)	Instance (decimal)	Attribute (decimal)	Description
864 (360 h)	0	Input Type (Dual Channel Mode)	4B	1	1	Safety Input 0 Configuration Data
	1	Input Range	49	1	3	
	2	Input Channel Mode	49	1	4	
	3	Filter Setting	49	1		
	4	Input Error Latch Time (Low Byte)	49	1	8	
	5	Input Error Latch Time (High Byte)	49	1	8	
	6	Low Engineering (Low Byte)	49	1	14	
	7	Low Engineering (High Byte)	49	1	14	
	8	High Engineering (Low Byte)	49	1	15	
	9	High Engineering (High Byte)	49	1	15	
	10	Tach Dual Low Check	49	1	104	
	11	Tach Trigger	49	1	105	
	12	Tach OFF Level	49	1	106	
	13	Tach ON Level	49	1	107	
	14	Sensor Power Mode	49	1	103	
	15	High High/Low Low Alarm Enable	49	1	17	
	16	High High/Low Low Alarm Trip High (Low Byte)	49	1	18	
	17	High High/Low Low Alarm Trip High (High Byte)	49	1	18	
	18	High High/Low Low Alarm Trip Low Low(Low Byte)	49	1	19	
	19	High High/Low Low Alarm Trip Low Low(High Byte)	49	1	19	
	20	High High/Low Low Alarm Deadband (Low Byte)	49	1	20	
	21	High High/Low Low Deadband (High Byte)	49	1	20	
	22	Pad Byte (Reserved)	49	...	...	
	23	High/Low Alarm Enable	49	1	22	
	24	High/Low Alarm Trip High (Low Byte)	49	1	23	
	25	High/Low Alarm Trip High (High Byte)	49	1	23	
	26	High/Low Alarm Trip Low (Low Byte)	49	1	24	
	27	High/Low Alarm Trip Low (High Byte)	49	1	24	
	28	High/Low Alarm Deadband (Low Byte)	49	1	25	
	29	High/Low Alarm Deadband High Byte)	49	1	25	
	30	Pad Byte 1	...	...	...	
31	Pad Byte 2	...	...	...		

**Table 34 - Configuration Assemblies for 1734-IE4S Input Modules (continued)**

Instance Decimal (hex)	Byte	Field	Class (hex)	Instance (decimal)	Attribute (decimal)	Description
864 (360 h)	32	Input Type (Dual Channel Mode)	4B	2	1	Safety Input 1 Configuration Data
	33	Input Range	49	2	3	
	34	Input Channel Mode	49	2	4	
	35	Filter Setting	49	2		
	36	Input Error Latch Time (Low Byte)	49	2	8	
	37	Input Error Latch Time (High Byte)	49	2	8	
	38	Low Engineering (Low Byte)	49	2	14	
	39	Low Engineering (High Byte)	49	2	14	
	40	High Engineering (Low Byte)	49	2	15	
	41	High Engineering (High Byte)	49	2	15	
	42	Tach Dual Low Check	49	2	104	
	43	Tach Trigger	49	2	105	
	44	Tach OFF Level	49	2	106	
	45	Tach ON Level	49	2	107	
	46	Sensor Power Mode	49	2	103	
	47	High High/Low Low Alarm Enable	49	2	17	
	48	High High/Low Low Alarm Trip High (Low Byte)	49	2	18	
	49	High High/Low Low Alarm Trip High (High Byte)	49	2	18	
	50	High High/Low Low Alarm Trip Low Low(Low Byte)	49	2	19	
	51	High High/Low Low Alarm Trip Low Low(High Byte)	49	2	19	
	52	High High/Low Low Alarm Deadband (Low Byte)	49	2	20	
	53	High High/Low Low Deadband (High Byte)	49	2	20	
	54	Pad Byte (Reserved)	49	...	...	
	55	High/Low Alarm Enable	49	2	22	
	56	High/Low Alarm Trip High (Low Byte)	49	2	23	
	57	High/Low Alarm Trip High (High Byte)	49	2	23	
	58	High/Low Alarm Trip Low (Low Byte)	49	2	24	
	59	High/Low Alarm Trip Low (High Byte)	49	2	24	
	60	High/Low Alarm Deadband (Low Byte)	49	2	25	
	61	High/Low Alarm Deadband High Byte)	49	2	25	
	62	Pad Byte 1	...	...	...	
	63	Pad Byte 2	...	...	...	

**Table 34 - Configuration Assemblies for 1734-IE4S Input Modules (continued)**

Instance Decimal (hex)	Byte	Field	Class (hex)	Instance (decimal)	Attribute (decimal)	Description
864 (360 h)	64	Input Type (Dual Channel Mode)	4B	3	1	Safety Input 2 Configuration Data
	65	Input Range	49	3	3	
	66	Input Channel Mode	49	3	4	
	67	Filter Setting	49	3		
	68	Input Error Latch Time (Low Byte)	49	3	8	
	69	Input Error Latch Time (High Byte)	49	3	8	
	70	Low Engineering (Low Byte)	49	3	14	
	71	Low Engineering (High Byte)	49	3	14	
	72	High Engineering (Low Byte)	49	3	15	
	73	High Engineering (High Byte)	49	3	15	
	74	Tach Dual Low Check	49	3	104	
	75	Tach Trigger	49	3	105	
	76	Tach OFF Level	49	3	106	
	77	Tach ON Level	49	3	107	
	78	Sensor Power Mode	49	3	103	
	79	High High/Low Low Alarm Enable	49	3	17	
	80	High High/Low Low Alarm Trip High (Low Byte)	49	3	18	
	81	High High/Low Low Alarm Trip High (High Byte)	49	3	18	
	82	High High/Low Low Alarm Trip Low Low(Low Byte)	49	3	19	
	83	High High/Low Low Alarm Trip Low Low(High Byte)	49	3	19	
	84	High High/Low Low Alarm Deadband (Low Byte)	49	3	20	
	85	High High/Low Low Deadband (High Byte)	49	3	20	
	86	Pad Byte (Reserved)	49	...	...	
	87	High/Low Alarm Enable	49	3	22	
	88	High/Low Alarm Trip High (Low Byte)	49	3	23	
	89	High/Low Alarm Trip High (High Byte)	49	3	23	
	90	High/Low Alarm Trip Low (Low Byte)	49	3	24	
	91	High/Low Alarm Trip Low (High Byte)	49	3	24	
	92	High/Low Alarm Deadband (Low Byte)	49	3	25	
	93	High/Low Alarm Deadband High Byte)	49	3	25	
	94	Pad Byte 1	...	...	...	
	95	Pad Byte 2	...	...	...	

**Table 34 - Configuration Assemblies for 1734-IE4S Input Modules (continued)**

Instance Decimal (hex)	Byte	Field	Class (hex)	Instance (decimal)	Attribute (decimal)	Description
864 (360 h)	96	Input Type (Dual Channel Mode)	49	4	1	Safety Input 3 Configuration Data
	97	Input Range	49	4	3	
	98	Input Channel Mode	49	4	4	
	99	Filter Setting	49	4		
	100	Input Error Latch Time (Low Byte)	49	4	8	
	101	Input Error Latch Time (High Byte)	49	4	8	
	102	Low Engineering (Low Byte)	49	4	14	
	103	Low Engineering (High Byte)	49	4	14	
	104	High Engineering (Low Byte)	49	4	15	
	105	High Engineering (High Byte)	49	4	15	
	106	Tach Dual Low Check	49	4	104	
	107	Tach Trigger	49	4	105	
	108	Tach OFF Level	49	4	106	
	109	Tach ON Level	49	4	107	
	110	Sensor Power Mode	49	4	103	
	111	High High/Low Low Alarm Enable	49	4	17	
	112	High High/Low Low Alarm Trip High (Low Byte)	49	4	18	
	113	High High/Low Low Alarm Trip High (High Byte)	49	4	18	
	114	High High/Low Low Alarm Trip Low Low(Low Byte)	49	4	19	
	115	High High/Low Low Alarm Trip Low Low(High Byte)	49	4	19	
	116	High High/Low Low Alarm Deadband (Low Byte)	49	4	20	
	117	High High/Low Low Deadband (High Byte)	49	4	20	
	118	Pad Byte (Reserved)	49	...	...	
	119	High/Low Alarm Enable	49	4	22	
	120	High/Low Alarm Trip High (Low Byte)	49	4	23	
	121	High/Low Alarm Trip High (High Byte)	49	4	23	
	122	High/Low Alarm Trip Low (Low Byte)	49	4	24	
123	High/Low Alarm Trip Low (High Byte)	49	4	24		
124	High/Low Alarm Deadband (Low Byte)	49	4	25		
125	High/Low Alarm Deadband High Byte)	49	4	25		
126	Pad Byte 1	...	...	...		
127	Pad Byte 2	...	...	...		
864 (360 h)	128	Ch 0_1 Discrepancy Time (Low Byte)	4B	1	3	Dual Channel Safety Input 0_1 Configuration
	129	Ch 0_1 Discrepancy Time (High Byte)	4B	1	3	
	130	Ch 0_1 Discrepancy Deadband (Low Byte)	4B	1	6	
	131	Ch 0_1 Discrepancy Deadband (High Byte)	4B	1	6	
	132	Ch 0_1 Channel Offset (Low Byte)	4B	1	100	
	133	Ch 0_1 Channel Offset (High Byte)	4B	1	100	
	134	Ch 2_3 Discrepancy Time (Low Byte)	4B	2	3	Dual Channel Safety Input 2_3 Configuration
	135	Ch 2_3 Discrepancy Time (High Byte)	4B	2	3	
	136	Ch 2_3 Discrepancy Deadband (Low Byte)	4B	2	6	
	137	Ch 2_3 Discrepancy Deadband (High Byte)	4B	2	6	
138	Ch 2_3 Channel Offset (Low Byte)	4B	2	100		
139	Ch 2_3 Channel Offset (High Byte)	4B	2	100		

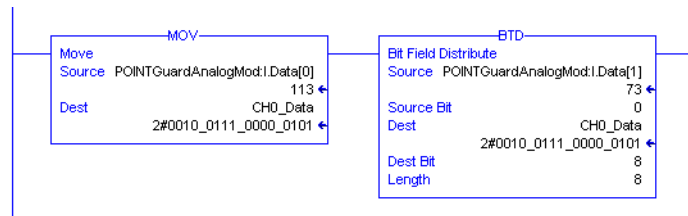


## Using Data from Modules Configured Via the Generic Profile

To use I/O assembly data from a 1734-IE4S module that is configured via the Generic Profile in your application program, you must first combine the input data from two SINTs into one INT. The following example shows one method for converting the data by using a Move instruction and a Bit Field Distribute instruction.

**EXAMPLE** This example uses Input Assembly Instance 802, which is described on page [214](#).

- POINTGuardAnalogMod.I.Data[0] = Channel 0 Low Byte (SINT)
- POINTGuardAnalogMod.I.Data[1] = Channel 0 High Byte (SINT)
- CHO\_Data = Combined Channel 0 data (INT) that can be used in an application program



**Notes:**

## Numerics

- 1734-AENT** 15
  - add and configure 77
  - firmware revision 78
- 1734-AENTR** 15
- 1734-EP24DC** 44, 45, 46
- 1734-EPAC** 44
- 1734-FPD** 44, 45
- 1734-IB8S**
  - field connections 59
  - muting lamp operation 40
- 1734-IB8S input assembly** 134
- 1734-IB8S output assembly** 134
- 1734-IE4S**
  - field connections 60
  - input range 29
  - power supply 57
- 1734-IE4S input assembly** 135
- 1734-OB8S**
  - field connections 59
  - single channel mode 39
- 1734-OB8S input assembly** 134
- 1734-OB8S output assembly** 134, 135
- 1734-OBV2S** 37
  - field connections 59
- 1734-PDN** 15, 110
  - auto-addressing 112
- 1734-TB** 53, 67
- 1734-TB3** 53
- 1734-TB3S** 53
- 1734-TBS** 53
- 1734-TOP** 53, 67
- 1734-TOP3** 53, 67
- 1734-TOP3S** 53
- 1734-TOPS** 53
- 1756-EN2T/A** 76

## A

- activate safety input data** 28
- Active state** 86
- adapter** 77
- add safety connection** 125
- Advanced Connection Reaction Time Limit** 105
- alarm** 31, 100
  - configuration 100
  - deadband 32, 100
  - over-range 42
  - under-range 42
- Alarm tab** 100
- analog input** 17
  - configuration tab 97
  - configure 94
  - data 104
  - status indicator 164
  - wiring 57, 67 ... 73

- architectures** 18
- auto-addressing** 112

## B

- broken wire** 29
  - detection 16, 42, 88
- Bulletin 100S** 12
- Bulletin 440G** 12
- Bulletin 440H** 12
- Bulletin 440K** 12
- Bulletin 440P** 12
- Bulletin 700S** 12
- Bulletin 800F** 12
- Bulletin 800T** 12
- Bulletin 802T** 12

## C

- Category** 15, 16, 19
- certification body** 12
- channel offset** 97
- chassis size** 79
- CIP safety** 145
  - architectures 18
  - protocol 15, 156
- Class 2** 43
- cleaning modules** 13
- combined input status** 42, 126
  - tag 84
  - tags 103
- combined output status** 42, 126
  - tags 103
- common terms** 9
- communication**
  - connections 42
- compatible module** 77, 78, 82, 91, 96
- conductors** 58
- configuration**
  - assemblies 215
  - download 107, 129
  - ownership 106, 148
  - safety 115
  - save 107, 129
  - settings 207
  - verify 139 ... 144
- configuration lock**
  - status indicator 163
- configuration signature** 106
  - comparison 144
  - copy 136
  - mismatch 140
- configure**
  - always 155

- connection** 9
    - example 146
    - lost 42
    - removable terminal block 56
    - safety input 105
  - connection faulted**
    - tags 103, 104, 106
  - connection reaction time limit** 127
  - contactors** 12
  - controller I/O data** 25
  - controlling devices** 12
  - copy**
    - configuration signature 136
    - safety network number 137
  - crossed cable example** 146
  - current input range** 29
  - cycle inputs** 86
- D**
- DC voltages** 58
  - DCA**
    - see Dual-channel Analog safety instruction
  - DCAF**
    - see Dual-channel Analog safety instruction
  - deadband** 32, 97
    - alarm 100
    - tolerance 33
  - delay time** 87
  - derating**
    - 1734-IB8S 174
    - 1734-IE4S 194
    - 1734-OB8S 175
  - device status**
    - Safety Device Verification Wizard 140
    - verification 141
  - DeviceNet safety**
    - architecture 18
    - conformance test 195
  - devices, safety** 15
  - diagnostic data** 42
  - digital input** 15
    - modules 80
    - status indicator 164
  - digital output** 16
    - status indicator 165
  - DIN rail** 58
  - disable keying** 77, 78
  - discharge, electrostatic** 53
  - discrepancy fault** 97, 120
  - discrepancy time** 15, 17, 25, 26, 27, 86, 97
  - door interlocking switch** 12
  - door monitoring switch** 61
  - download configuration** 107, 129
  - download DeviceNet configuration** 138 . . .
    - 144
  - dual low inputs detection** 101
  - dual-channel** 93
    - complementary 25, 27, 86
    - complimentary 21
    - discrepancy error 42
    - discrepancy fault 33
    - equivalent 21, 22, 25, 26, 29, 33, 86, 97, 98, 120
    - mode 15, 16, 17, 25, 38, 39
    - safety contactors 65
    - wiring 63, 65
  - Dual-channel Analog safety instruction** 97, 99
- E**
- EDS**
    - See electronic data sheet
  - electronic data sheet** 9, 110
  - electronic keying** 91, 96
  - electrostatic discharge** 53
  - emergency stop switch** 12, 61, 105
    - wiring 63
  - EN**
    - 60079-0 51
  - enclosure** 52
  - environment** 52
  - equivalent** 26
  - E-stop**
    - See emergency stop switch
  - EtherNet/IP**
    - safety architecture 18
  - Ethernet/IP**
    - module 76
  - exact match** 77, 78, 82, 91, 96
  - example**
    - connections not made 146
    - crossed cable 146
  - explicit messaging** 84, 88
  - external means** 82, 91, 96
- F**
- falling edge** 102
  - fault**
    - detection 24, 26, 38, 39
    - monitoring 15
    - reason 104, 169
    - recovery 28, 39
  - fault detection** 27
  - field**
    - connection 59
    - power 44
  - field power distributor** 44, 45
  - filter** 99
  - firmware** 12
  - functional verification test** 19

**G**

**gate monitoring switch**  
wiring 63  
**generic DeviceNet safety module profile** 131, 132  
**glossary** 9  
**grounding** 58  
**GuardLogix controller** 131  
SNN 147  
**Guardmaster product** 12

**H**

**hazardous location** 51, 52  
**High alarm** 31, 42, 100  
status 104  
**High Engineering value** 29, 99  
**High High alarm** 31, 42, 100  
status 104  
**hold last state** 88

**I**

**I/O**  
assemblies 211  
replacement 155  
status data 15  
**icon**  
device status 140  
**IEC**  
60204-1 195  
61131-2 195  
61508 11, 195  
62061 195  
**input**  
assemblies 211  
signal lines 23  
**input assembly**  
1734-IB8S 134  
1734-IE4S 135  
1734-OB8S 134  
**input configuration tab** 85  
**input data** 82, 103  
**input delay time** 87  
**input delays**  
See on-delay and off-delay  
**input error latch time** 88, 98  
**input filter** 99  
**input power error bit** 103  
**input status**  
analog 42  
combined 42  
point 42  
tags 84  
**install**  
I/O modules 55  
mounting base 53  
removable terminal block 56  
**ISO 13849-1** 11, 195

**K**

**keyswitches** 55

**L**

**legislations and standards** 195  
**light curtain** 62  
**limit switches** 12  
**listen only** 79  
**lock**  
See safety-lock  
**Logix Designer application** 75  
reset module 148  
**lost connection** 42  
**Low alarm** 31, 42, 100  
status 104  
**Low Engineering value** 29, 99  
**Low Low alarm** 31, 42, 100  
status 104  
**Low Voltage Directive** 43  
**LVD** 43

**M**

**masters** 9  
**mean time between failure** 197  
**message instructions** 167  
configure 168  
**mismatch**  
configuration signature 140  
**missing device**  
icon 140  
**module**  
guidelines 9, 11  
precautions 13  
status indicator 162  
**mounting** 53 . . . 57  
**mounting base**  
assembly 53  
connect the module 55  
install 53  
installation 53  
remove 57  
uninstall 57  
**MS status indicator** 107, 129  
**muting lamp** 16, 40, 88  
status 103  
**muting status** 126  
tag 84

**N**

**network adapters** 15  
**network delay multiplier** 106  
**network status indicator**  
See NS status indicator  
**node address** 110  
**node conditioning tool** 111

**NPN-style sensors** 34, 67  
**NS status indicator** 107, 129, 152, 154, 158, 163

## O

**ODVA** 9, 195  
**off-delay** 15, 28, 87  
**off-level** 35  
**on-delay** 15, 28, 87  
**on-level** 35  
**online button** 138  
**out-of-box** 151  
     reset module 147  
**output**  
     assemblies 212  
     monitor 42  
     safe state 21  
     signals 16  
**output assembly**  
     1734-IB8S 134  
     1734-OB8S 134, 135  
**Output Configuration tab** 93  
**output data** 103  
     menu 83  
     tag 103  
     tags 83  
**Output Error Latch Time** 94  
**output power error bit** 103  
**output readback**  
     tags 103  
**output status**  
     combined 42  
     monitor 42  
     point 42  
     test outputs 42  
**overfrequency bit** 36  
**ownership** 106, 129

## P

**packet size** 126, 127  
**parameters**  
     safety configuration 117, 120  
**PELV** 43  
**Performance Level** 15, 16, 17  
**PFD** 9, 19  
     See probability of failure on demand.  
**PFH** 9, 19  
     See probability of failure per hour.  
**PL** 19  
**PLC controllers** 18  
**PNP-style sensors** 34, 67  
**point input status** 42, 103, 126  
**Point mode**  
     digital input 87  
     test output 88  
**point operation type** 86

**point output status** 42  
     tags 103  
**POINTBus**  
     backplane 43, 44  
**Pollution Degree 2** 52  
**power**  
     field 44  
     status 126  
     status indicator 163  
**power supply** 43, 44  
     examples 45 . . . 46  
     external 57, 73  
     sensor outputs 73  
**probability of failure**  
     on demand 9, 197  
     per hour 9, 197  
**process alarms** 31  
     configuration 100  
     tags 104  
**proof test** 9  
**protected extra-low voltage** 43  
**publications, related** 10  
**pulse count** 102  
**pulse period** 23, 37  
**pulse test** 16, 87, 93  
     output specifications 173, 185  
**pulse testing** 87  
**pulse width** 23, 37  
**push button** 61

## R

**rack optimization** 79  
**readback** 104  
     tags 103  
**ready to be safety locked** 143  
**ready to be verified** 141  
**redundant control** 16  
**related publications** 10  
**relays with forcibly-guided contacts** 12  
**removable terminal block** 53, 56  
     connect 56  
**remove**  
     mounting base 57  
**replace**  
     configure always enabled 155  
     configure only . . . enabled 150  
     modules 13, 157  
**requested packet interval** 105  
**reset**  
     module 147  
     ownership 148  
**resistors** 67  
**response time** 37  
**rising edge** 102  
**risk assessment** 12  
**RPI** 105  
**RSLinx software** 110, 114

- RSLogix 5000 software**
    - version 17
  - RSNetWorx for DeviceNet software** 11, 109, 114, 145
    - reset module 149
    - version 17
  - RSWho** 114
  - RTB** 56
    - See removable terminal block
  - run mode**
    - tag 103, 104
- S**
- safe state** 21, 22
  - safety**
    - administrator 9, 13
    - analog input 17
    - analog inputs 29
    - application requirements 19
    - configuration 115
    - configuration tab 115, 119
    - devices 15
    - digital input data 24
    - digital input modules 80
    - digital inputs 15, 22
    - digital outputs 16, 37, 39
    - extra-low voltage 43
    - input connection 105
    - input data 28
    - input fault recovery 28
    - input status 24
    - inputs 126
    - monitor 126
    - output modules 89
    - output specifications 175, 188, 190
    - output with test pulse 37
    - outputs 13, 21, 126
    - sensors 12
    - system architecture 18
    - tab 105
  - safety connection tab** 124
  - safety contactor**
    - wiring 64, 65
  - Safety Device Verification Wizard**
    - definition 139
    - device status 140
    - reports 143
    - run 139
    - safety-lock
    - select devices 141
    - summary 144
    - upload and compare 142
    - Welcome page 139
  - safety extra-low voltage** 43
  - safety instruction** 97, 99
  - safety network number** 9, 19, 81, 90, 95, 106, 145, 146
    - copy 137
    - error icon 140
    - mismatch 157
    - setting 146 ... 147
  - safety signature** 19, 146
  - safety task watchdog** 94, 98
  - safety-lock**
    - devices
    - icon 140
  - save** 107, 129
  - scaling**
    - analog inputs 29
  - schematic diagrams** 61
  - SELV** 43
  - sensor power**
    - outputs 57
    - over-range 42
    - status indicator 163
    - under-range 42
  - sensors**
    - NPN-style 34
    - PNP-style 34
    - power supply 73, 99
    - wiring 67
  - sequential auto-addressing** 112
  - short-circuit**
    - between input signal lines 23
    - detection 15
  - short-circuit detection** 16
  - SIL** 19
  - single-channel** 21, 22, 86, 93, 97, 120
    - discrepancy error 42
    - mode 15, 17, 24, 29
    - safety contactor 64
    - wiring 64
  - slaves** 9
  - SLogix 5000 software**
    - version 17
  - SmartGuard controller**
    - SNN 147
  - SNN** 9, 19
    - See safety network number
    - See safety network number.
  - standard** 9
    - output data 103
    - outputs 16
  - standards**
    - legislations 195
  - states of tags** 103
  - status bits**
    - input power error 103
    - muting 40, 41
    - output power error 103
  - status data** 41, 103, 104
    - input and controller 25
  - status indicators** 13, 107, 161
    - analog inputs 164
    - configuration 163
    - module 162
    - network 163
    - safety input 164
    - safety output 165
    - sensor power 163
  - stuck high faults** 39
  - Studio 5000 environment** 9
    - version 17

**suitability for use** 12

**switch**

- door interlocking 12
- door monitoring 61
- emergency stop 105
- gate monitoring 63
- limit 12

**system reaction time** 19

## T

**tachometer**

- dual low inputs detection 42, 101, 104
- frequency 34
- frequency over-range 42
- frequency under-range 42
- input wiring 57
- mode 29, 34, 101
- off-level 35, 102
- on-level 35, 102
- overfrequency 104
- reset 104
- status indicator 164
- under-frequency 104
- wiring 67

**tags** 103

- combined input status 84
- input data 82
- input status 84
- muting status 84
- output data 83, 91
- output status 92
- status and alarms 96
- status, alarms, fault 96
- values 103, 104

**terminology** 9

**Test Output Fault Action parameter** 88

**test outputs** 13, 15, 16, 22, 40, 83, 84, 87

- clear off 88
- configure 88
- hold last state 88
- status 42, 126
- status tags 103
- tab 88

**test pulse** 23, 37

**test source** 87

**this controller** 82, 91, 96

**timeout multiplier** 106

## U

**UL** 43

**uninstall**

- mounting base 57

**unknown device**

- icon 140

**upload and compare**

- Safety Device Verification Wizard 142

**USB** 109, 110

## V

**verification reports**

- failure report 143
- Safety Device Verification Wizard 143

**verify**

- DeviceNet Safety configuration 139 ... 144
- FAILED 143
- select devices 141

**verify failed** 141

**verify not supported** 141

**voltage input range** 29

## W

**warning**

- configuration 100

**welcome page** 139

**wiring**

- analog inputs 67 ... 73
- conductors 58
- dual-channel devices 63
- emergency stop switch 63
- examples 63 ... 73
- gate monitoring switch 63
- modules 57 ... 73
- redundant safety contactor 65
- safety contactor 64
- sensors 67
- single-channel 64
- tachometer inputs 67





# Rockwell Automation Support

Use the following resources to access support information.

<b>Technical Support Center</b>	Knowledgebase Articles, How-to Videos, FAQs, Chat, User Forums, and Product Notification Updates.	<a href="https://rockwellautomation.custhelp.com/">https://rockwellautomation.custhelp.com/</a>
<b>Local Technical Support Phone Numbers</b>	Locate the phone number for your country.	<a href="http://www.rockwellautomation.com/global/support/get-support-now.page">http://www.rockwellautomation.com/global/support/get-support-now.page</a>
<b>Direct Dial Codes</b>	Find the Direct Dial Code for your product. Use the code to route your call directly to a technical support engineer.	<a href="http://www.rockwellautomation.com/global/support/direct-dial.page">http://www.rockwellautomation.com/global/support/direct-dial.page</a>
<b>Literature Library</b>	Installation Instructions, Manuals, Brochures, and Technical Data.	<a href="http://www.rockwellautomation.com/global/literature-library/overview.page">http://www.rockwellautomation.com/global/literature-library/overview.page</a>
<b>Product Compatibility and Download Center (PCDC)</b>	Get help determining how products interact, check features and capabilities, and find associated firmware.	<a href="http://www.rockwellautomation.com/global/support/pcdc.page">http://www.rockwellautomation.com/global/support/pcdc.page</a>

## Documentation Feedback

Your comments will help us serve your documentation needs better. If you have any suggestions on how to improve this document, complete the How Are We Doing? form at [http://literature.rockwellautomation.com/idc/groups/literature/documents/du/ra-du002\\_-en-e.pdf](http://literature.rockwellautomation.com/idc/groups/literature/documents/du/ra-du002_-en-e.pdf).

Rockwell Automation maintains current product environmental information on its website at <http://www.rockwellautomation.com/rockwellautomation/about-us/sustainability-ethics/product-environmental-compliance.page>.

Allen-Bradley, CompactBlock, Guard I/O, GuardLogix, Guardmaster, POINTBus, POINT Guard I/O, POINT I/O, Rockwell Automation, Rockwell Software, RSLinx, RSLogix 5000, RSNetWorx, SmartGuard, Studio 5000, and Studio 5000 Logix Designer are trademarks of Rockwell Automation, Inc.

Trademarks not belonging to Rockwell Automation are property of their respective companies.

Rockwell Otomasyon Ticaret A.Ş., Kar Plaza İş Merkezi E Blok Kat:6 34752 İçerenköy, İstanbul, Tel: +90 (216) 5698400

**[www.rockwellautomation.com](http://www.rockwellautomation.com)**

---

### Power, Control and Information Solutions Headquarters

Americas: Rockwell Automation, 1201 South Second Street, Milwaukee, WI 53204-2496 USA, Tel: (1) 414.382.2000, Fax: (1) 414.382.4444

Europe/Middle East/Africa: Rockwell Automation NV, Pegasus Park, De Kleetlaan 12a, 1831 Diegem, Belgium, Tel: (32) 2 663 0600, Fax: (32) 2 663 0640

Asia Pacific: Rockwell Automation, Level 14, Core F, Cyberport 3, 100 Cyberport Road, Hong Kong, Tel: (852) 2887 4788, Fax: (852) 2508 1846

Publication 1734-UM013N-EN-P - September 2017

Supersedes Publication 1734-UM013M-EN-P - May 2017

Copyright © 2017 Rockwell Automation, Inc. All rights reserved. Printed in the U.S.A.



***Allen-Bradley***

***POINT Guard I/O Safety Modules***

***User Manual***