

# *Installation Instructions*

## **ArmorPOINT I/O DeviceNet Adapters**

Catalog Numbers 1738-ADN12, 1738-ADN18, 1738-ADN18P,  
1738-ADNX, Series A

<b>Topic</b>	<b>Page</b>
Important User Information	2
Environment and Enclosure	3
Prevent Electrostatic Discharge	3
About the Adapter	4
Mount the I/O Base	5
Install the Adapter	6
Set the Network Address	7
Wire the Adapter	8
Interpret Status Indicators	10
Specifications	13

### Important User Information

Solid state equipment has operational characteristics differing from those of electromechanical equipment. Safety Guidelines for the Application, Installation and Maintenance of Solid State Controls (publication [SGI-1.1](#) available from your local Rockwell Automation sales office or online at <http://literature.rockwellautomation.com>) describes some important differences between solid state equipment and hard-wired electromechanical devices. Because of this difference, and also because of the wide variety of uses for solid state equipment, all persons responsible for applying this equipment must satisfy themselves that each intended application of this equipment is acceptable.





In no event will Rockwell Automation, Inc. be responsible or liable for indirect or consequential damages resulting from the use or application of this equipment.

The examples and diagrams in this manual are included solely for illustrative purposes. Because of the many variables and requirements associated with any particular installation, Rockwell Automation, Inc. cannot assume responsibility or liability for actual use based on the examples and diagrams.

No patent liability is assumed by Rockwell Automation, Inc. with respect to use of information, circuits, equipment, or software described in this manual.

Reproduction of the contents of this manual, in whole or in part, without written permission of Rockwell Automation, Inc., is prohibited.

Throughout this manual, when necessary, we use notes to make you aware of safety considerations.

<b>WARNING</b> 	Identifies information about practices or circumstances that can cause an explosion in a hazardous environment, which may lead to personal injury or death, property damage, or economic loss.
<b>IMPORTANT</b>	Identifies information that is critical for successful application and understanding of the product.
<b>ATTENTION</b> 	Identifies information about practices or circumstances that can lead to personal injury or death, property damage, or economic loss. Attentions help you to identify a hazard, avoid a hazard, and recognize the consequences.
<b>SHOCK HAZARD</b> 	Labels may be on or inside the equipment, for example, a drive or motor, to alert people that dangerous voltage may be present.
<b>BURN HAZARD</b> 	Labels may be on or inside the equipment, for example, a drive or motor, to alert people that surfaces may reach dangerous temperatures.

---

## Environment and Enclosure

Follow these guidelines for environment and enclosure information for this equipment.

---

**ATTENTION**

This equipment is intended for use in overvoltage Category II applications (as defined in IEC 60664-1), at altitudes up to 2000 m (6562 ft) without derating. This equipment is considered Group 1, Class A industrial equipment according to IEC/CISPR 11. Without appropriate precautions, there may be difficulties with electromagnetic compatibility in residential and other environments due to conducted and radiated disturbances.

This equipment is supplied as enclosed equipment. It should not require additional system enclosure when used in locations consistent with the enclosure type ratings stated in the Specifications section of this publication. Subsequent sections of this publication may contain additional information regarding specific enclosure type ratings, beyond what this product provides, that are required to comply with certain product safety certifications.

In addition to this publication, see:

- Industrial Automation Wiring and Grounding Guidelines, Rockwell Automation publication [1770-4.1](#), for additional installation requirements.
- NEMA Standard 250 and IEC 60529, as applicable, for explanations of the degrees of protection provided by different types of enclosure.

---

## Prevent Electrostatic Discharge

Follow these guidelines when you handle this equipment.

---

**ATTENTION**

This equipment is sensitive to electrostatic discharge that can cause internal damage and affect normal operation. Follow these guidelines when you handle this equipment.

- Touch a grounded object to discharge potential static.
  - Wear an approved grounding wrist strap.
  - Do not touch connectors or pins on component boards.
  - Do not touch circuit components inside the equipment.
  - Use a static-safe workstation if available.
  - Store the equipment in appropriate static-safe packaging when not in use.
-

## About the Adapter

The ArmorPOINT I/O family of DeviceNet adapters ship with the adapter and a terminating base to be used with the last I/O module on the backplane. The sealed IP67 housing of these adapters requires no enclosure. Note that environmental requirements other than IP67 may require an additional appropriate housing. DeviceNet connectors are sealed M12 (micro) or M18 (mini) styles.

## ArmorPOINT I/O DeviceNet Adapters

**1738-ADN12**

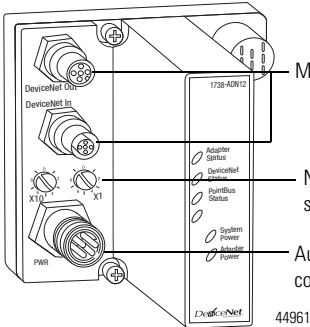

**1738-ADNX**

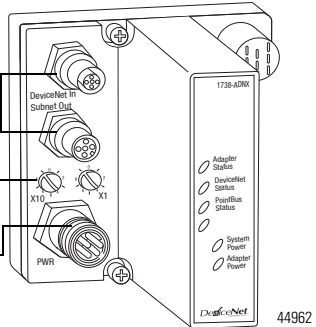

**1738-ADN18**

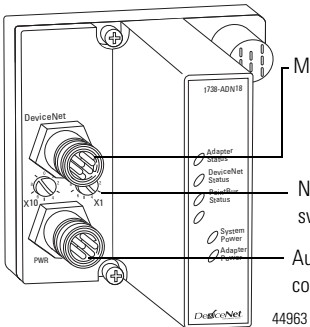

**1738-ADN18P**

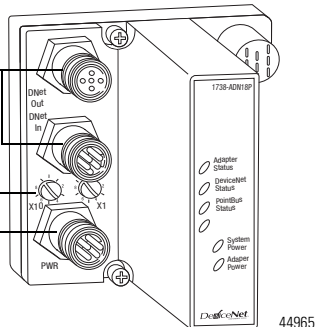

## Mount the I/O Base

Mount the I/O base on a wall or panel, use the screw holes provided in the adapter.

### IMPORTANT

The ArmorPOINT I/O module must be mounted on a grounded metal mounting plate or other conductive surface.

### ATTENTION



To comply with the CE Low Voltage Directive (LVD), all connected I/O must be powered from a source compliant with the following:  
Safety Extra Low Voltage (SELV) or Protected Extra Low Voltage (PELV).

### ATTENTION



This product is intended to be mounted to a well-grounded mounting surface such as a metal panel. Additional grounding connections from the power supply mounting tabs or DIN rail (if used) are not required unless the mounting surface cannot be grounded. Refer to Industrial Automation Wiring and Grounding Guidelines, Rockwell Automation publication [1770-4.1](#), for additional information.

## Mounting illustration for the ArmorPOINT I/O adapter with I/O bases

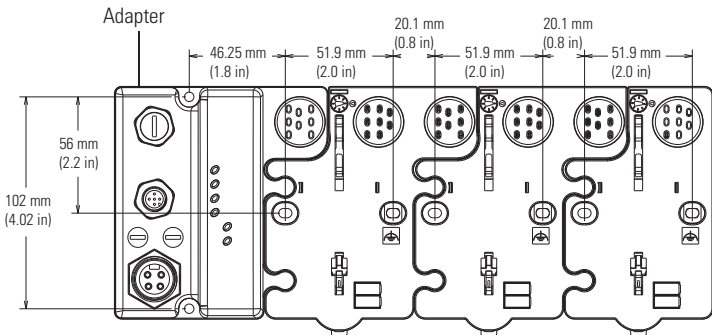

43769

## 6 ArmorPOINT I/O DeviceNet Adapters

---

Install the mounting as follows:

1. Lay out the required points as shown in the drilling dimension drawing.
2. Drill the necessary holes for M4 (#8) machine or self-tapping screws.
3. Mount the base using M4 (#8) screws.
4. Ground the system using the ground lug connection.  
The ground lug connection is also a mounting hole.

### Mounting Base

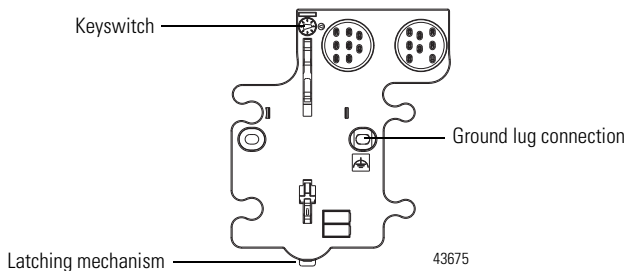

### Install the Adapter

Follow the instructions to install the adapter.

1. Using a bladed screwdriver, rotate the keyswitch on the mounting base clockwise until the number 1 aligns with the notch in the base.
2. Position the module vertically above the mounting base.  
The module bridges two bases.
3. Push the module down until it engages the latching mechanism.  
You will hear a clicking sound when the module is properly engaged.  
The locking mechanism locks the module to the base.

## Remove the Adapter From the Mounting Base

Follow the instructions to remove the adapter from the mounting base.

1. Put a flat blade screwdriver into the slot of the orange latching mechanism.
2. Push the screwdriver toward the I/O module to disengage the latch. The module lifts up off the base.
3. Pull the module off the base.

## Set the Network Address

Valid node addresses are 00...63.

Set the node address using either the rotary switches, RSNetWorx for DeviceNet, DeviceNetManager, or another software configuration tool. Setting the switches at any number from 64...99 allows the software to have address control.

Each module is shipped with the switches set for node address 63. Remove the caps on the front of the module to access the switches. The two switches are:

- X10 (most significant digit) – left side of module
- X1 (least significant digit) – right side of module

## Network Node Example

This example shows the network address set at 63.

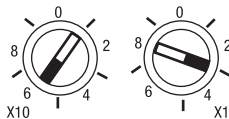

44316

To reset the node address, use a small blade screwdriver to rotate the switches. Line up the small notch on the switch with the number setting you wish to use and then cycle power.

The I/O adapter periodically reads the rotary switches. If the switches have changed since the last reading and they no longer match the online address, a

minor fault occurs, which is indicated by a flashing red Adapter Status LED. Settings of 64...99 cause the module to use the last valid node address stored internally. Example: The last setting internally was 40. If a change is made to 68, and then you power up, the address will default to 40.

The module is equipped with AutoBaud detect. AutoBaud lets the module read the settings already in use on your DeviceNet network and automatically adjusts to follow those settings.

### Wire the Adapter

Follow the wiring instructions for the ArmorPOINT I/O DeviceNet adapters.

#### 1738-ADN12 and 1738-ADNX

Male in connector

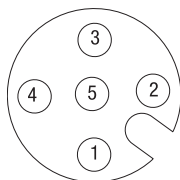

43763

(View into connector)

- Pin 1 Drain
- Pin 2 +V
- Pin 3 -V
- Pin 4 CAN\_High
- Pin 5 CAN\_Low

Female out connector (1738-ADN12)  
(Subnet out – 1738-ADNX only)

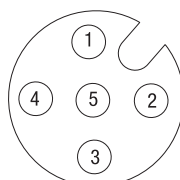

43764

#### 1738-ADN18, 1738-ADN18P

Male in connector

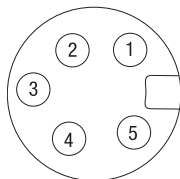

43746

(View into connector)

- Pin 1 Drain
- Pin 2 +V
- Pin 3 -V
- Pin 4 CAN\_High
- Pin 5 CAN\_Low

Female out connector  
(1738-ADN18P only)

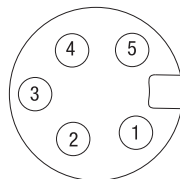

43749



---

## Auxiliary Power

Attach the mini-style 4-pin connector to the mini-style 4-pin receptacle as shown below.

Male in Connector

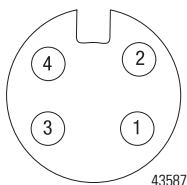

(View into connector)

- Pin 1 User power+
- Pin 2 Adapter power+  
Adapter/Subnet+ (1738-ADNX only)
- Pin 3 Adapter power-  
Adapter/Subnet- (1738-ADNX only)
- Pin 4 User power-

---

**ATTENTION**

Make sure all connectors and caps are securely tightened to properly seal the connections against leaks and maintain IP enclosure type requirements.

---

**ATTENTION**

To comply with the CE Low Voltage Directive (LVD), this equipment and all connected I/O must be powered from a source compliant with the following: Safety Extra Low Voltage (SELV) or Protected Extra Low Voltage (PELV).

---

## Interpret Status Indicators

This module has the following status indicators:

- Adapter, DeviceNet and POINTBus status indicators
- System and Adapter power indicators

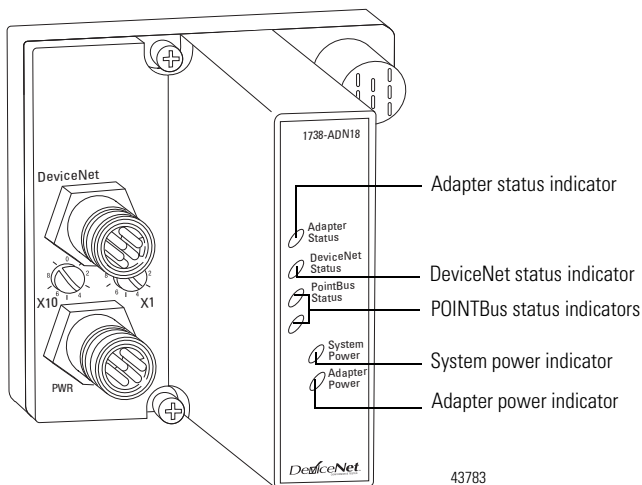

## Indicator Status

Indicator	Status	Description
Adapter status	Off	No power applied to device.
	Green	Device operating normally.
	Red	Unrecoverable fault – may require device replacement.
	Flashing red	Recoverable fault
	Flashing red/green	Device is in self-test.

**Indicator Status**

<b>Indicator</b>	<b>Status</b>	<b>Description</b>
DeviceNet status	Off	Device is not online: - Device attempting to AutoBaud - Device has not completed dup_MAC-ID test - Device not powered – check adapter status indicator.
	Flashing green	Device is online but has no connections in the established state.
	Green	The device is online and has connections in the established state.
	Flashing red	One or more connections have timed out.
	Red	Critical link failure – failed communication device. Device detected error that prevents it from communicating on the network. Possible duplicate MAC ID or baud rate mismatch.
POINTBus status	Off	Device is not online: - Device has not completed dup_MAC-ID test - Device not powered – check adapter status indicator.
	Green	Device is online and has connections in the established state.
	Flashing green	Device is online but has no connections in the established state.
	Red	Critical link failure – failed communication device. Device detected error that prevents it from communicating on the network. Possible duplicate MAC ID or baud rate mismatch.
	Flashing red	One or more I/O connections in timed out state.
	Flashing red/green	Communication faulted device – the device has detected a network access error and is in communication faulted state. Device has received and accepted an Identify Communication Faulted Request – long protocol message.
POINTBus status (1738-ADNX only)	Off	No power applied to device. Device not online Device has not completed dup_MAC_ID test.
	Green	Subnet online and has connections in the established state.
	Red	Unrecoverable fault may require device replacement. There is possible duplicate MAC ID or baud rate mismatch.
	Flashing red	Recoverable fault: - No scanlist configured - Problem with module in scanlist (missing, mismatch).

### Indicator Status

<b>Indicator</b>	<b>Status</b>	<b>Description</b>
System power	Off	Not active – field power is off or DC-DC converter problem.
	Green	System power on – DC-DC converter active (5V).
Adapter power	Off	Not active – field power is off.
	Green	Power on, 24V present.

## Specifications

Attributes	Value
Expansion I/O capacity	<p>63 modules max.</p> <p>Actual number of modules can vary. Add up current requirements of modules you want to use to make sure they do not exceed the amperage limit of 1.0 A for the ArmorPOINT I/O DeviceNet adapter.</p> <p>Backplane current can be extended beyond 1.0 A with a 1738-EP24DC Backplane Extension Power Supply. The 1738-EP24DC can supply up to an additional 1.3 A of backplane current.</p> <p>Add multiple 1738-EP24DC modules to reach the 63 module max.</p>
POINTBus current requirements	<p>75 mA – 1738-IB2M12, 1738-IB4xxx, 1738-IB8xxx, 1738-IV4xxx, 1738-OB2EM12, 1738-OB2EPM12, 1738-OB4Exxx, 1738-OB8Exxx, 1738-OV4EM12, 1738-IE2CM12, 1738-OE2CM12, 1738-IE2VM12, 1738-OE2VM12, 1738-IA2xxx, 1738-OA2xxx, 1738-IT2IM12, 1738-232ASC12, 1738-485ASC12</p> <p>90 mA – 1738-OW4xxx</p> <p>110 mA – 1738-SSIM23</p> <p>160 mA – 1738-IJM23</p> <p>180 mA – 1738-VHSC24M23</p> <p>220 mA – 1738-IR2M12</p>
DeviceNet communication Baud rates Distance, max	<p>125, 250, 500 Kbps</p> <p>500 m (1630 ft) @ 125 Kbps</p> <p>250 m (820 ft) @ 250 Kbps</p> <p>100 m (328 ft) @ 500 Kbps</p>
DeviceNet cable	<p>Allen-Bradley part number 1485C-P1-Cxxx</p> <p>Refer to publication <a href="#">NETS-SG001</a> for more information</p>
Input voltage rating, nom	24V DC
DeviceNet input voltage range	11...25V DC DeviceNet specification
Input overvoltage protection	Reverse polarity protected
DeviceNet power requirements	24V DC (+4% = 25V DC) @ 50 mA max

## Power Supply Specifications

Attributes	Value
Input voltage rating, nom	24V DC
Input voltage range	10...28.8V DC
Input overvoltage protection	Reverse polarity protected
Inrush current	6 A max for 10 ms
POINTBus output current, max	1 A @ 5V DC $\pm 5\%$ (4.75...5.25)
Field side power requirements, max	24V DC (+20% = 28.8V DC) @ 400 mA
Interruption	Output voltage stays within specifications when input drops out for 10 ms @ 10V with max load

## General Specifications

Attribute	Value
Power consumption, max	8.1W @ 28.8V DC
Power dissipation, max	2.8W @ 28.8V DC
Thermal dissipation, max	935 BTU/hr. @ 28.8V DC
Isolation voltage	50V (continuous), Basic Insulation Type Type tested at 800V DC for 60 s, Comm to System, Comm to User power, Comm to Ground, User power to System, User power to Ground and System to Ground.
Field power bus voltage, nom	24V DC
Field power bus supply voltage range	10...28.8V DC
Field power bus supply current, max	10 A
LED indicators	1 green/red Adapter status 1 green/red DeviceNet status 1 green/red POINTBus status 1 green System Power (POINTBus 5V power) 1 green Adapter Power (24V from field supply)
Dimensions (HxWxD), approx.	112 x 72 x 65 mm (4.41 x 2.83 x 2.56 in.)
Weight, approx.	360 g (12.7 oz)
Enclosure type rating	Meets IP65/66/67/69K (when marked)

## General Specifications

Mounting base screw torque	M4 (#8) screw 0.86 Nm (7.5 lb-in) in Aluminum 1.81 Nm (16 lb-in) in Steel
Wiring category <sup>(1)</sup>	1 – on power ports 1 – on communications ports

<sup>(1)</sup> Use this Conductor Category information for planning conductor routing. Refer to publication [1770-4.1](#), Industrial Automation Wiring and Grounding Guidelines.

## Environmental Specifications

Attribute	Value
Temperature, operating	IEC 60068-2-1 (Test Ad, Operating Cold), IEC 60068-2-2 (Test Bd, Operating Dry Heat), IEC 60068-2-14 (Test Nb, Operating Thermal Shock): -20...60 °C (-4...140 °F)
Temperature, non-operating	IEC 60068-2-1 (Test Ab, Unpackaged Non-operating Cold), IEC 60068-2-2 (Test Bb, Unpackaged Non-operating Dry Heat), IEC 60068-2-14 (Test Na, Unpackaged Non-operating Thermal Shock): -40...85 °C (-40...185 °F)
Relative humidity	IEC 60068-2-30 (Test Db, Unpackaged Damp Heat): 5...95% non-condensing
Vibration	IEC60068-2-6 (Test Fc, Operating): 5 g @ 10...500 Hz
Shock, operating	IEC60068-2-27 (Test Ea, Unpackaged Shock): 30 g
Shock, non-operating	IEC60068-2-27 (Test Ea, Unpackaged Shock): 50 g
Emissions	CISPR 11: Group 1, Class A
ESD immunity	IEC 61000-4-2: 6 kV contact discharges 8 kV air discharges
Radiated RF immunity	IEC 61000-4-3: 10V/m with 1 kHz sine-wave 80% AM from 80...2000 MHz 10V/m with 200 Hz 50% Pulse 100% AM @ 900 Mhz 10V/m with 200 Hz 50% Pulse 100% AM @ 1890 Mhz  3V/m with 1 kHz sine-wave 80% AM from 2000...2700 MHz (1738-ADN12, 1738-ADN18 and 1738-ADN18P only)

## Environmental Specifications

Attribute	Value
EFT/B immunity	IEC 61000-4-4: ±4 kV @ 5 kHz on power ports ±3 kV @ 5 kHz on communications ports
Surge transient immunity	IEC 61000-4-5: ±1 kV line-line(DM) and ±2 kV line-earth(CM) on power ports ±2 kV line-earth(CM) on communications ports
Conducted RF immunity	IEC 61000-4-6: 10V rms with 1 kHz sine-wave 80% AM from 150 kHz...80 MHz

## Certifications

Certification (when product is marked) <sup>(1)</sup>	Value
CE	European Union 2004/108/EU EMC Directive, compliant with: EN 61326-1; Meas./Control/Lab., Industrial Requirements EN 61000-6-2; Industrial Immunity EN 61000-6-4; Industrial Emissions EN 61131-2; Programmable Controllers (Clause 8, Zone A & B)
C-Tick	Australian Radiocommunications Act, compliant with: AS/NZS CISPR 11; Industrial Emissions
ODVA	ODVA conformance tested to DeviceNet specifications

- <sup>(1)</sup> See the Product Certification link at <http://www.ab.com> for Declaration of Conformity, Certificates, and other certification details.

Allen-Bradley, Rockwell Automation, RSNetWorx, DeviceNetManager, ArmorPOINT I/O and TechConnect are trademarks of Rockwell Automation, Inc.

Trademarks not belonging to Rockwell Automation are property of their respective companies.

Rockwell Otomasyon Ticaret A.Ş., Kar Plaza İş Merkezi E Blok Kat:6 34752 İçerenköy, İstanbul, Tel: +90 (216) 5698400

[www.rockwellautomation.com](http://www.rockwellautomation.com)

### Power, Control and Information Solutions Headquarters

Americas: Rockwell Automation, 1201 South Second Street, Milwaukee, WI 53204-2496 USA, Tel: (1) 414.382.2000, Fax: (1) 414.382.4444  
Europe/Middle East/Africa: Rockwell Automation, Vorstaan/Boulevard du Souverain 36, 1170 Brussels, Belgium, Tel: (32) 2 663 0600, Fax: (32) 2 663 0640  
Asia Pacific: Rockwell Automation, Level 14, Core F, Cyberport 3, 100 Cyberport Road, Hong Kong, Tel: (852) 2887 4788, Fax: (852) 2508 1846

Publication 1738-IN014D-EN-E - December 2010

Supersedes Publication 1738-IN014C-EN-E - December 2009

Copyright © 2010 Rockwell Automation, Inc. All rights reserved.