

1756 ControlLogix Digital Safety I/O Modules

Catalog Numbers 1756-IB16S, 1756-OBV8S



Important User Information

Read this document and the documents listed in the additional resources section about installation, configuration, and operation of this equipment before you install, configure, operate, or maintain this product. Users are required to familiarize themselves with installation and wiring instructions in addition to requirements of all applicable codes, laws, and standards.

Activities including installation, adjustments, putting into service, use, assembly, disassembly, and maintenance are required to be carried out by suitably trained personnel in accordance with applicable code of practice.

If this equipment is used in a manner not specified by the manufacturer, the protection provided by the equipment may be impaired.

In no event will Rockwell Automation, Inc. be responsible or liable for indirect or consequential damages resulting from the use or application of this equipment.

The examples and diagrams in this manual are included solely for illustrative purposes. Because of the many variables and requirements associated with any particular installation, Rockwell Automation, Inc. cannot assume responsibility or liability for actual use based on the examples and diagrams.

No patent liability is assumed by Rockwell Automation, Inc. with respect to use of information, circuits, equipment, or software described in this manual.

Reproduction of the contents of this manual, in whole or in part, without written permission of Rockwell Automation, Inc., is prohibited.

Throughout this manual, when necessary, we use notes to make you aware of safety considerations.



WARNING: Identifies information about practices or circumstances that can cause an explosion in a hazardous environment, which may lead to personal injury or death, property damage, or economic loss.



ATTENTION: Identifies information about practices or circumstances that can lead to personal injury or death, property damage, or economic loss. Attentions help you identify a hazard, avoid a hazard, and recognize the consequence.

IMPORTANT

Identifies information that is critical for successful application and understanding of the product.

Labels may also be on or inside the equipment to provide specific precautions.



SHOCK HAZARD: Labels may be on or inside the equipment, for example, a drive or motor, to alert people that dangerous voltage may be present.



BURN HAZARD: Labels may be on or inside the equipment, for example, a drive or motor, to alert people that surfaces may reach dangerous temperatures.



ARC FLASH HAZARD: Labels may be on or inside the equipment, for example, a motor control center, to alert people to potential Arc Flash. Arc Flash will cause severe injury or death. Wear proper Personal Protective Equipment (PPE). Follow ALL Regulatory requirements for safe work practices and for Personal Protective Equipment (PPE).

**Digital Safety I/O Module
Operation in a Control System**

Preface7
Terminology..... 7
Additional Resources 8

Chapter 1

Overview 10
 Controller and Software Compatibility..... 11
Overall System Safety Function..... 12
 Determine Conformity 12
 1756-IB16S Single-channel Point Operation Type 14
 1756-OBV8S Single-channel or Dual-channel
 Point Operation Type 14
 Obtain Firmware..... 15
 Safety Precautions 16
 Safety Application Requirements 17
 Safe State 18
 Configuration Signature and Ownership 19
 Reset 1756 ControlLogix Digital Safety I/O Modules to
 Out-of-Box State 20
About the Modules..... 21
Local I/O Modules or Remote I/O Modules 23
 Local I/O Modules 23
 Remote I/O Modules 24
Ownership 24
Construct a System..... 25
 Local I/O Modules 26
 Remote I/O Modules 26
Configure the Modules 26
 Connections with 1756 ControlLogix Digital Safety
 I/O Modules..... 27
 Requested Packet Interval 30
 Connection Over an EtherNet/IP Network 31
Input Module Operation 31
 Local 1756 ControlLogix Digital Safety Input Modules..... 31
 Remote 1756 ControlLogix Digital Safety Input Modules 32
Output Module Operation 32
 Local Safety Output Modules..... 33
 Remote Safety Output Modules 33
External Means 35
Protected Operations..... 36

Features Common to 1756 ControlLogix Digital Safety I/O Modules	<p>Chapter 2</p> <ul style="list-style-type: none"> Input Module Compatibility 38 Output Module Compatibility 38 Software Configurable 39 Module Data Quality Reporting 40 Fault and Status Reporting 41 Module Inhibiting 41 Electronic Keying 43 <ul style="list-style-type: none"> More Information 43 Module Firmware 44 Producer/Consumer Communication 44 <p>Chapter 3</p> <ul style="list-style-type: none"> Overview 45 Safety Application Suitability Level 46 Use Test Output with a Safety Input 47 Single-channel Point Operation Type 49 Safety Input Fault Reset 50 <ul style="list-style-type: none"> 'Latch Fault until reset via output tag' mode is Enabled 50 'Latch Fault until reset via output tag' mode is Disabled 50 Safety Input Delay Time 50 <ul style="list-style-type: none"> Off to On Delay 51 On to Off Delay 52 Data Transfer at RPI 52 Module Health Diagnostic 52 Point Diagnostics 53 Fault and Status Reporting 54 Field Power Loss Detection 55 Short Circuit Protection 56 <ul style="list-style-type: none"> Test Output Recovery After Overload or Short Circuit to Ground Condition 56 <p>Chapter 4</p> <ul style="list-style-type: none"> Overview 58 Safety Application Suitability Level 59 Safety Output with Test Pulse 60 Single-channel Point Operation Type 61 Dual-channel Point Operation Type 62 Safety Output Fault Reset 63 <ul style="list-style-type: none"> 'Latch Fault until reset via output tag' mode is Enabled 63 'Latch Fault until reset via output tag' mode is Disabled 63 Fault and Status Reporting 64 Module Health Diagnostics 64 Point Diagnostics 65 Field Power Loss Detection 66 No Load Detection 67
1756-IB16S Input Module Features	
1756-OBV8S Output Module Features	

Short Circuit Protection	68
Other Conditions That Can Trigger the Short Circuit	
Diagnostic on the 1756-OBV8S Module	69
Output Recovery After Overload or Short Circuit to	
Ground Condition	70
Thermal Shutoff	70
Fault and Status Reporting.....	71
Configurable Channel-level Output State in Program Mode or	
Fault Mode	71
Connection Fault Handling.....	72
Output Behavior Immediately After a Connection Fault.....	72
Output State Once Connection is Re-established	72
Forcing.....	73
Enable Forces	73
Disable or Remove a Force	74
Check Force Status	74
GSV Instruction.....	75

Chapter 5

Configure and Replace Safety Modules

Create a New Module	78
New Local Safety Module	78
New Remote I/O Module.....	80
Edit the Module Configuration Common Categories	82
General Category.....	83
Connection Category.....	85
Safety Category.....	86
Module Info Category	87
Edit the 1756-IB16S Module Configuration Categories	88
Input Points Category	88
Test Output Points Category.....	89
Edit the 1756-OBV8S Module Points Category	90
Point Mode.....	91
Output State During Program Mode and Communications Fault	
Mode.....	91
View the Module Tags.....	92
Replace a Safety Module	93
Reset to Out-of-Box Configuration	93
Replace a Module in a Logix 5000 System	95

Troubleshoot Your Module	<p>Appendix A</p> <p>Module Status Indicators 103</p> <p> OK Status Indicators 104</p> <p>Use the Logix Designer Application for Troubleshooting. 105</p> <p> Warning Signal in the I/O Configuration Tree 105</p> <p> Status and Fault Information in</p> <p> Module Properties Categories 106</p> <p> Module and Point Diagnostics. 108</p> <p> Logix Designer Application Tag Editor. 110</p> <p>InternalFault Triggered on the Safety Output Module 111</p>
Module Tag Definitions	<p>Appendix B</p> <p>Access the Tags 114</p> <p>Name Conventions 114</p> <p>1756-IB16S Module Tags..... 115</p> <p> Input Tags 115</p> <p> Output Tags 116</p> <p>1756-OBV8S Module Tags 117</p> <p> Input Tags 117</p> <p> Output Tags 118</p>
Application and Wiring Examples for Safety Modules	<p>Appendix C</p> <p>Before You Begin. 119</p> <p>1756-IB16S Module Wiring Diagrams..... 120</p> <p>1756-OBV8S Module Wiring Diagrams 123</p> <p> Bipolar Mode 123</p> <p> Sourcing Mode 126</p>
Safety Data for Safety Modules	<p>Appendix D</p> <p>1756-IB16S Safety Data 130</p> <p>1756-OBV8S Safety Data..... 131</p>
	<p>Index133</p>

This manual describes how to use 1756 ControlLogix® Digital Safety I/O modules in Logix 5000™ control systems.

Make sure that you are familiar with the following:

- Use of a safety controller in a Logix 5000 control system.
- Use of safety systems.
- Use Studio 5000 Logix Designer® application environment.

Terminology

The following table defines terms that are used in this manual.

Abbreviation	Full Term	Definition
1oo2	One out of Two	Identifies the programmable electronic controller architecture.
CIP™	Common Industrial Protocol	An industrial communication protocol that is used by Logix 5000-based automation systems on EtherNet/IP™, ControlNet®, and DeviceNet® communication networks.
CIP Safety™	Common Industrial Protocol – Safety Certified	SIL-rated version of CIP.
—	Connection	Logical communication channel for communication between nodes. Connections are maintained and controlled between masters and slaves.
CL	Claim Limit	The maximum safety integrity level (SIL) that can be achieved.
DC	Diagnostic Coverage	The ratio of the detected failure rate to the total failure rate.
EDS	Electronic Data Sheet,	A template that is used in RSNetWorx™ software to display the configuration parameters, I/O data profile, and connection-type support for a given I/O module. RSNetWorx software uses these simple text files to identify products and commission them on a network.
EN	European Norm.	The official European Standard.
GSV	Get System Value	A ladder logic instruction that retrieves specified controller status information and places it in a destination tag.
—	Multicast	The transmission of information from one sender to multiple receivers.
NAT	Network Address Translation	The translation of an Internet Protocol (IP) address to another IP address on another network.
ODVA	Open DeviceNet Vendor Association	A nonprofit association of vendors that are established for the promotion of CIP networks.
PC	Personal computer	Computer that is used to interface with and control a Logix-based system via the Studio 5000® environment.
PFD	Probability of a dangerous failure on demand	The average probability of a system to fail to perform its design function on demand.
PFH	Average frequency of a dangerous failure per hour	The probability of a system to have a dangerous failure occur per hour.
PL	Performance Level	ISO 13849-1 safety rating.
—	Process safety time	Period of time between a failure, that has the potential to give rise to a hazardous event, occurring in the Equipment Under Control (EUC) or EUC control system and the time by which action has to be completed in the EUC to help prevent the hazardous event occurring.
—	Proof test	Periodic test that detects failures in a safety-related system so that, if necessary, the system can be restored to an as-new condition or as close as practical to this condition.
SIL	Safety Integrity Level	A relative level of risk-reduction that is provided by a safety function, or to specify a target level of risk reduction.
SNN	Safety Network Number	Safety network number, which uniquely identifies a network across all networks in the safety system. You are responsible for assigning a unique number for each safety network or safety subnet within a system.
SSV	Set System Value	A ladder logic instruction that sets controller system data.
—	Standard	Devices or portions of devices that do not participate in the safety function.
—	Unicast	The transmission of information from one sender to one receiver.

Additional Resources

These resources contain information about related products from Rockwell Automation.

Resource	Description
1756 ControlLogix 16-point Sinking Safety Input Module Installation Instructions, publication 1756-IN079A-EN-P	Provides installation information for the 1756-IB16S safety input module.
1756 ControlLogix 8-point Safety Bipolar/Sourcing Output Module Installation Instructions, publication 1756-IN081A-EN-P	Provides installation information for the 1756-OBV8S safety output module.
ControlLogix Chassis Installation Instructions, publication 1756-IN621	Provides installation information for ControlLogix chassis.
ControlLogix Power Supply Installation Instructions, publication 1756-IN619	Provides installation information for ControlLogix power supplies.
ControlLogix I/O Modules Specifications Technical Data, publication 1756-TD002	Provides specifications, wiring diagrams, and schematics for ControlLogix I/O modules.
GuardLogix 5580 and Compact GuardLogix 5380 Controller Systems Safety Reference Manual, publication 1756-RM012	Provides information on how to achieve and maintain Safety Integrity Level (SIL) and Performance Level (PL) safety application requirements for GuardLogix® 5580 and Compact GuardLogix 5380 controllers.
ControlLogix 5580 and GuardLogix 5580 Controllers User Manual, publication 1756-UM543	Provides information on how to install, configure, program, and use ControlLogix 5580 controllers and GuardLogix 5580 controllers in Studio 5000 Logix Designer application projects.
Safety Automation Builder and SISTEMA Library	<p>Download Safety Automation Builder® software to help simplify machine safety design and validation, and reduce time and costs. Integration with our risk assessment software provides you with consistent, reliable, and documented management of the Functional Safety Lifecycle.</p> <p>The SISTEMA tool, also available for download from the Safety Automation Builder page, automates calculation of the attained Performance Level from the safety-related parts of a machine's control system to (EN) ISO 13849-1.</p>
Industrial Automation Wiring and Grounding Guidelines, publication 1770-4.1	Provides general guidelines for installing a Rockwell Automation industrial system.
Product Certifications website, rok.auto/certifications	Provides declarations of conformity, certificates, and other certification details.

Digital Safety I/O Module Operation in a Control System

Topic	Page
Overview	10
Overall System Safety Function	12
About the Modules	21
Local I/O Modules or Remote I/O Modules	23
Ownership	24
Construct a System	25
Configure the Modules	26
Input Module Operation	31
Output Module Operation	32
External Means	35
Protected Operations	36

Overview

GuardLogix® controllers use 1756-IB16S and 1756-OBV8S modules to control devices in a control system.

Table 1 - 1756 ControlLogix® Digital Safety I/O Modules

Module Type	Cat. No.	Description
Safety ⁽¹⁾	1756-IB16S	18...32V DC 16-point sinking safety input module
	1756-OBV8S	18...32V DC 8-point, safety output module that can be used as: <ul style="list-style-type: none"> • Bipolar output module • Sourcing output module

(1) You can use the safety modules in applications that are rated up to, and including, SIL CL3, PLe, Cat. 4 as defined in IEC 61508, IEC 61511, IEC 62061, and ISO 13849-1.

ControlLogix modules mount in a ControlLogix chassis, and require a removable terminal block (RTB) to connect all field-side wiring.

IMPORTANT A ControlLogix system with 1756-IB16S and 1756-OBV8S safety I/O modules has been agency certified using only the ControlLogix RTB catalog numbers 1756-TBCHS, 1756-TBNHS, 1756-TBSHS, and 1756-TBS6HS.

Any application that requires agency certification of the ControlLogix system using other wiring termination methods can require application-specific approval by the certifying agency.



ATTENTION: To comply with the CE Low Voltage Directive (LVD), this equipment, and all connected I/O, must be powered from a safety extra low voltage (SELV) or protected extra low voltage (PELV) compliant source.

For UL-compliant applications, the 1756-IB16S and 1756-OBV8S modules, and all connected IO, must be powered from a SELV or PELV-compliant power source that is rated 150VA maximum.

IMPORTANT All other I/O modules in the same chassis must use an SELV/PELV power supply.

Controller and Software Compatibility

Controller and programming software compatibility requirements apply when you use 1756 ControlLogix digital I/O modules.

Table 2 - Controller and Software Compatibility Requirements

Safety Modules	Location	Controller System	Cat. Nos.	Supported Communication Protocol	Studio 5000 Logix Designer® application
1756-IB16S, 1756-OBV8S	Local	GuardLogix 5580	1756-L81ES, 1756-L82ES, 1756-L83ES, 1756-L84ES, 1756-L8SP	1756 Backplane	Version 32.00.00 or later, with Add-on Profile.
	Remote	GuardLogix 5580	1756-L81ES, 1756-L82ES, 1756-L83ES, 1756-L84ES	EtherNet/IP™	
		Compact GuardLogix 5380	5069-L306ERS2, 5069-L306ERMS2, 5069-L310ERS2, 5069-L310ERMS2, 5069-L320ERS2, 5069-L320ERS2K, 5069-L320ERMS2, 5069-L320ERMS2K, 5069-L330ERS2, 5069-5069-L330ERS2K, L330ERMS2, 5069-L330ERMS2K, 5069-L340ERS2, 5069-L340ERMS2, 5069-L350ERS2, 5069-L350ERS2K, 5069-L350ERMS2, 5069-L350ERMS2K, 5069-L380ERS2, 5069-L380ERMS2, 5069-L3100ERS2, 5069-L3100ERMS2		

Overall System Safety Function

The following apply to the modules:

- Type-approved and certified for use in safety applications up to and including SIL 3 per IEC 61508
- Suitable for use in safety applications up to and including SIL CL 3 per IEC 62061
- Suitable for use in safety applications up to and including Performance Level e (PLe), category 4 per ISO 13849-1

IMPORTANT Functional safety certification and performance of 1756-IB16S and 1756-OBV8S modules requires that the modules operate in conditions at or below the ambient operating temperature specification.

The probability of a dangerous failure on demand (PFD) and average frequency of a dangerous failure per hour (PFH) calculations for these modules are based on the module operating conditions adhering to the ambient operating temperature specification.

For more information on the maximum ambient operating temperature specification, see the 1756 ControlLogix I/O Specifications Technical Data, publication [1756-TD002](#).

IMPORTANT Requirements are based on the standards current at the time of certification.

For more information on safety application suitability levels:

- [1756-IB16S Input Module Features on page 45](#)
 - [1756-OBV8S Output Module Features on page 57](#)
-

Determine Conformity



ATTENTION: Use only appropriate components or devices that comply with the relevant safety standards and meet the required safety integrity level or Performance Level and safety category.

- Conformity to the requirements of the relevant safety standards must be determined for the entire system by conducting a risk assessment.
- Use devices properly according to the installation environment, performance rating, and functions of the machine.
- Use devices within their specified ratings.
- We recommend that you consult a certification body regarding assessment of conformity to the required safety integrity level or Performance Level.

You are responsible for confirming compliance with the applicable standards for the entire system. You must read, understand, and fulfill the functional safety requirements of the standard applicable to your safety application.

The type approval, certification, and suitability levels for 1756-IB16S and 1756-OBV8S modules describe a system with an overall system safety function of SIL 3. However, you are not required to use 1756 ControlLogix digital safety I/O modules only in safety applications with an overall system safety function of SIL 3.

For example, a GuardLogix 5580 controller without a 1756-L8SP safety partner is suitable for use in safety applications that are rated up to, and including, SIL CL2, PLd, Cat. 3 as defined in IEC 61508, IEC 61511, IEC 62061, and ISO 13849-1. You can use 1756-IB16S and 1756-OBV8S modules in such an application.

GuardLogix 5580 controllers, when used with a 1756-L8SP safety partner are suitable for use in safety applications that are rated up to, and including SIL 3, and PLe, cat. 4 as defined in IEC 61508, IEC 61511, IEC 62061, and ISO 13849-1. You can use 1756-IB16S and 1756-OBV8S modules in such an application.

For more information on the suitability level of Logix 5000™ safety controllers, see the GuardLogix 5580 and Compact GuardLogix 5380 Controller Systems Safety Reference Manual, publication [1756-RM012](#).

1756-IB16S Single-channel Point Operation Type

The 1756-IB16S module is single-channel Point Operation Type only. The module channels are pre-configured and fixed at single channel Point Operation Type. The signal status of each channel is evaluated. Based on that status, safety input data and safety input status can be off or on.

To detect discrepancy faults between the channels of a dual channel safety device, use dual channel safety instructions the GuardLogix safety task, for example, the Dual Channel Input Stop (DCS) instruction.

1756-OBV8S Single-channel or Dual-channel Point Operation Type

You can use the 1756-OBV8S modules only in single-channel Point Operation Type while in bi-polar mode. Bi-polar single channel Point Operation Type consists of a P-M pair. P is the sourcing terminal, and M is the sinking terminal.

In sourcing mode, you can configure single channel or dual-channel Point Operation Type. In sourcing, dual-channel Point Operation Type, both channels must always be in the same logical state.

Dual-channel Point Operation Type is typically used when both safety outputs are controlling the same load. Rockwell Automation recommends configuring the module for dual-channel Point Operation Type in dual-channel applications because it decreases the dangerous undetectable failure rate (λ_{DU}) within the module.

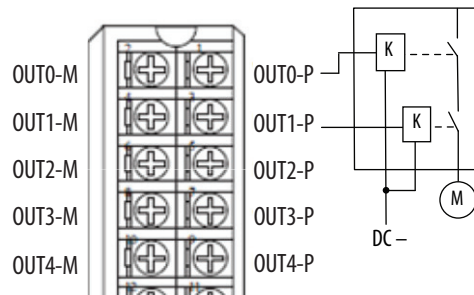

Obtain Firmware

Verify that the firmware revision of the 1756-IB16S and 1756-OBV8S modules that you use is correct before commissioning the system.

Firmware information for safety I/O devices is available at the Rockwell Automation Product Compatibility and Download Center (PCDC). The PCDC is available at:

<https://compatibility.rockwellautomation.com/Pages/home.aspx>

Only download firmware and access product release notes from the Rockwell Automation PCDC.

Do not download firmware from non-Rockwell Automation sites.

Safety Function During Firmware Update

The 1756-IB16S and 1756-OBV8S modules are not safety capable when a firmware update is in process. You must use other methods to maintain the safety function during the update process.

For information on how to maintain the safety function during the update process, for example, remove the module from service to perform the update, see the GuardLogix and Compact GuardLogix 5380 Controller Systems Safety Reference Manual, publication [1756-RM012](#).

Safety Precautions



ATTENTION: Personnel responsible for the application of safety-related programmable electronic systems (PES) shall be aware of the safety requirements in the application of the system and shall be trained in the use of the system.

Observe these precautions for the proper use 1756 ControlLogix digital safety I/O modules.



ATTENTION: As serious injury can occur due to loss of required safety function, follow these safety precautions.

- Never use test outputs as safety outputs. Test outputs are not safety outputs.
 - Do not use standard I/O data or explicit message data as safety data.
 - Do not use the light-emitting diode (LED) status indicators on the I/O modules for safety operations.
 - Do not connect loads beyond the rated value to the safety outputs.
 - Apply properly specified voltages to the module. Applying inappropriate voltages can cause the module to fail to perform its specified function, which could lead to loss of safety functions or damage to the module.
 - Wire the 1756 ControlLogix digital safety I/O modules as shown in the 1756 ControlLogix I/O Specifications Technical Data, publication [1756-TD002](#).
 - Set unique network node addresses before you connect devices to the network.
 - Perform testing to confirm that device wiring, configuration, and operation is correct before you start system operation.
 - Do not disassemble, repair, or modify the module. This can result in loss of safety functions.
-

For more information about safety precautions, see [Ownership on page 24](#).

Installing and Replacing Modules



ATTENTION:

- Configure the replacement device properly and confirm that it operates correctly.
 - After installation of the module, a safety administrator must confirm the installation and conduct trial operation and maintenance.
-

Safety Application Requirements

Safety application requirements include evaluating the following:

- Probability of failure rates (PFD and PFH)
- System reaction time settings
- Functional verification tests that fulfill appropriate safety-level criteria

Creating, recording, and verifying the safety signature is also a required part of the safety application development process. The safety controller creates the safety signatures. The safety signature consists of an identification number, date, and time that uniquely identifies the safety portion of a project. This number includes all safety logic, data, and safety I/O configuration.

For safety system requirements, including information on the safety network number (SNN), verifying the safety signature, functional verification test intervals, system reaction time, and PFD/PFH calculations, see the GuardLogix 5580 and Compact GuardLogix 5380 Controller Systems Safety Reference Manual, publication [1756-RM012](#).

You must read, understand, and fulfill the requirements that are described in this publication before you operate a safety system that uses 1756 ControlLogix digital safety I/O modules.

Safe State



ATTENTION:

- The safe state of the outputs is defined as the off state.
- The safe state of the module and its data is defined as the off state.
- Use the 1756 ControlLogix digital safety I/O modules only in applications where the off state is the safe state.

The following are the safe states of the safety modules:

- Safety outputs: OFF
- Safety input data to network: OFF

Figure 1 - Safety Status

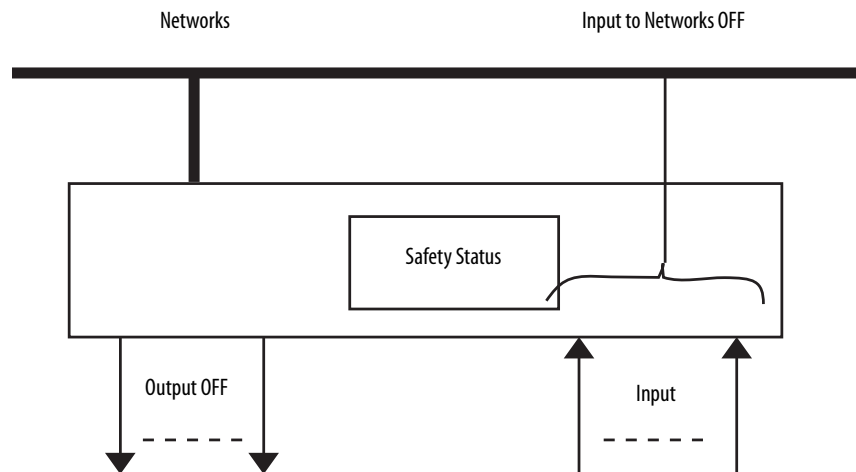

The modules are designed for use in applications where the safe state is the off state.

IMPORTANT If you inhibit a safety module from transitioning to a safe state when a fault occurs because an I/O connection is lost, you accept responsibility for any consequences that result from your decision to inhibit. We recommend that you use other means to maintain the safe state if you inhibit the safety module from transitioning to a safe state.

Configuration Signature and Ownership

Every 1756 ControlLogix digital safety I/O module in a system has a configuration signature and configuration ownership.

Configuration Signature

Each safety device has a unique configuration signature that defines the module configuration. The configuration signature includes the following:

- ID number
- Date
- Time

The configuration signature is used to verify a module's configuration.

Configuration Ownership

The connection between the owner-controller and the 1756 ControlLogix digital safety I/O module is based on the following:

- 1756 ControlLogix digital safety I/O module node number
- 1756 ControlLogix digital safety I/O module safety network number
- Controller node or slot number

IMPORTANT If the owner-controller is a GuardLogix 5580 controller, the controller has a slot number.

- Controller safety network number
- Path from the controller to the 1756 ControlLogix digital safety I/O module
- Configuration signature

If any differences are detected, the connection between the owner-controller and the 1756 ControlLogix digital safety I/O module is lost, the yellow yield icon appears in the controller project tree.

Different Configuration Owner

When a controller owns the I/O module configuration, other controllers can listen to the input module. In this case, the module configuration signature in the Logix Designer application project for any listening controller must match the one in the owner-controller project.

TIP If the safety module is configured for inputs only, you can copy and paste the configuration signature from one project to the other.

If the safety module has safety outputs, for example, the 1756-0BV8S module, the configuration signature parameter is disabled.

Reset 1756 ControlLogix Digital Safety I/O Modules to Out-of-Box State

If a 1756 ControlLogix digital safety I/O module was used previously, you must clear the configuration ownership before you can install it on a safety network. That is, you must return the module configuration to its out-of-box state.

When a 1756 ControlLogix digital safety I/O module is in the out-of-box state, its configuration is not owned by a controller.

The Safety category on the Module Properties dialog box displays the module Configuration Ownership. The Logix Designer application project must be online to check.

If the module configuration is owned, the Safety category displays whether the controller for the opened project owns the module configuration or another controller owns it.

For information on how to reset the module in the Logix Designer application, see [Reset to Out-of-Box Configuration on page 93](#).

You cannot reset the module to its out-of-box configuration if any of the following conditions exist:

- There are pending edits to the module properties.
- When a safety signature exists in the controller project.

The I/O modules use removable terminal blocks (RTBs) to connect field-side wiring. You use the Studio 5000 Logix Designer application to configure the modules (see [Controller and Software Compatibility on page 11](#)).

The I/O modules use the Producer/Consumer network communication model. This communication is an intelligent data exchange between modules and other system devices in which each module produces data without first being polled.

About the Modules

Figure 2 below and Figure 3 on page 22 show the parts of a 1756 ControlLogix digital safety I/O modules.

Figure 2 - Example 1756-IB18S Module

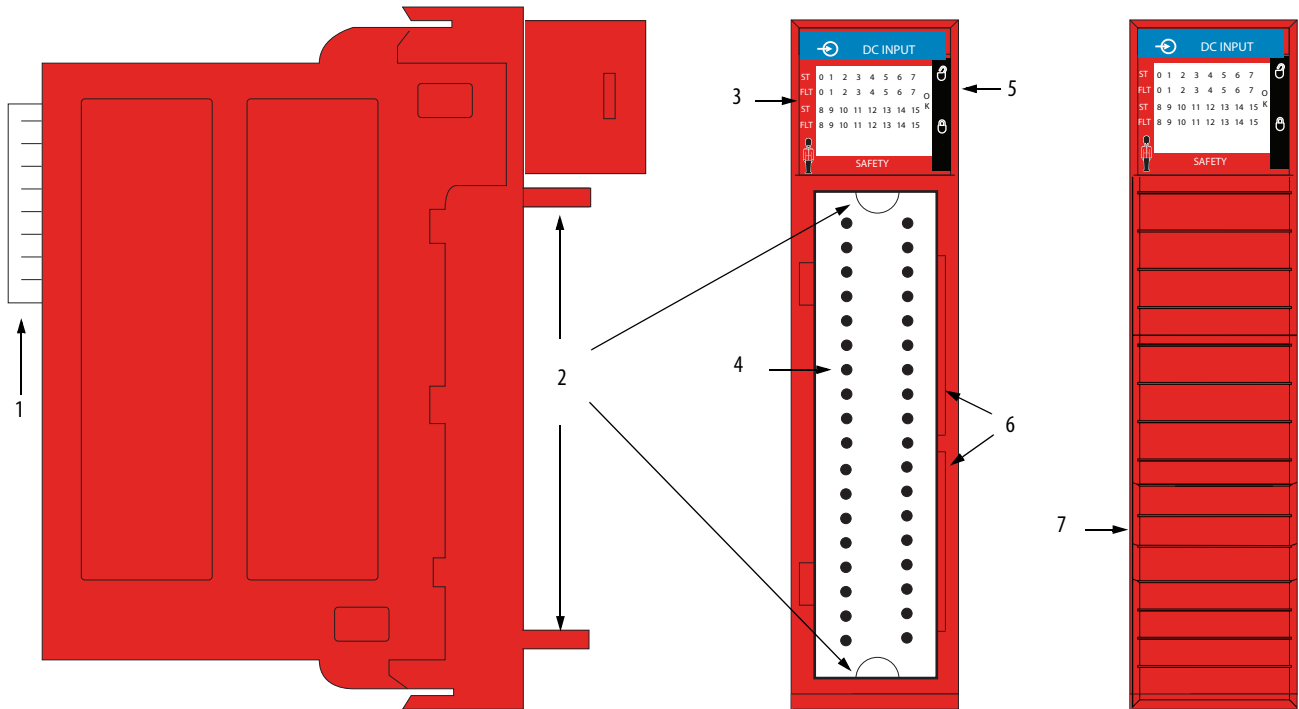

Item	Description
1	Backplane Connector —Interface for the ControlLogix system that connects the module to the backplane.
2	Top and bottom guides —Guides provide assistance in seating the RTB onto the module.
3	Status indicators —Indicators display the status of communication, module health, and input/output devices. Indicators help in troubleshooting anomalies.
4	Connector pins —Input/output, power, and grounding connections are made to the module through these pins with the use of an RTB.
5	Locking tab —The locking tab anchors the RTB on the module, maintaining wiring connections.
6	Slots for keying —Mechanically keys the RTB to help prevent making the wrong wire connections to your module.
7	Module with RTB installed

Figure 3 - Example 1756-OBV8S

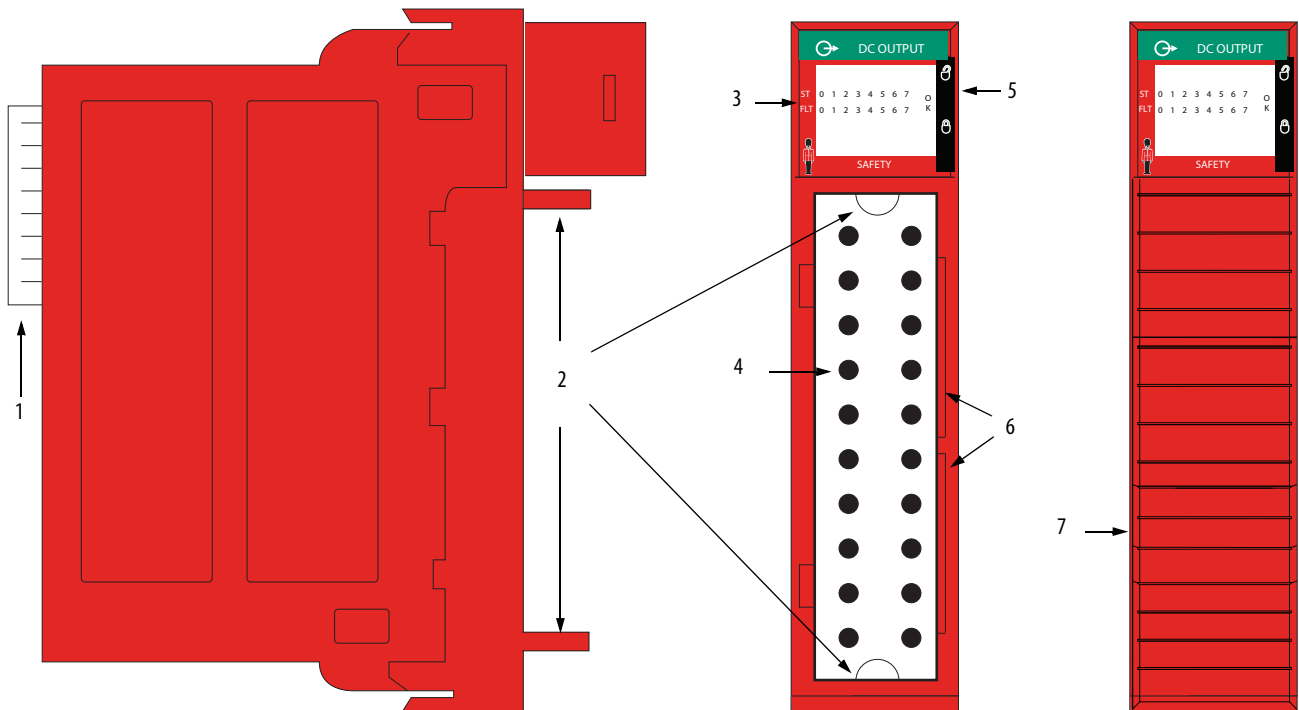

Item	Description
1	Backplane Connector —Interface for the ControlLogix system that connects the module to the backplane.
2	Top and bottom guides —Guides provide assistance in seating the RTB onto the module.
3	Status indicators —Indicators display the status of communication, module health, and input/output devices. Indicators help in troubleshooting anomalies.
4	Connector pins —Input/output, power, and grounding connections are made to the module through these pins with the use of an RTB.
5	Locking tab —The locking tab anchors the RTB on the module, maintaining wiring connections.
6	Slots for keying —Mechanically keys the RTB to help prevent making the wrong wire connections to your module.
7	Module with RTB installed

Local I/O Modules or Remote I/O Modules

You can use 1756 ControlLogix digital safety I/O modules as local or remote I/O modules, with some restrictions that are based on the module and controller type. Compatibility requirements apply and are described in [Controller and Software Compatibility on page 11](#).

Local I/O Modules

When I/O modules reside in the same system as the controller, the modules are local I/O modules.

Figure 4 - Local 1756 ControlLogix digital safety I/O modules

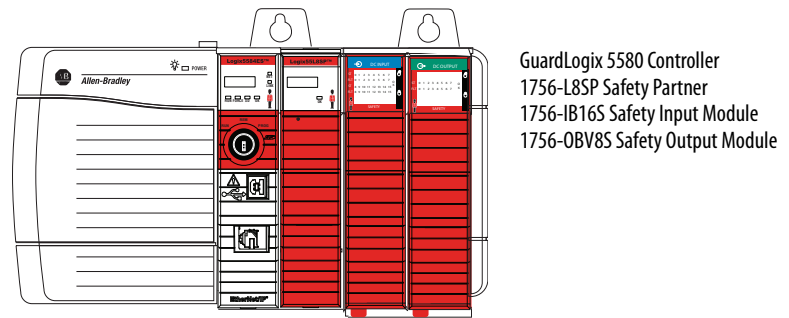

Remote I/O Modules

When 1756 ControlLogix digital safety I/O modules reside in a separate location from a GuardLogix 5580 or Compact GuardLogix 5380 controller, they are remote I/O modules.

Remote 1756 ControlLogix digital safety I/O modules are accessible over an EtherNet/IP network via a 1756 ControlLogix EtherNet/IP adapter.

Figure 5 shows remote safety I/O modules in a GuardLogix 5580 control application.

Figure 5 - Remote Safety I/O Modules in a GuardLogix 5580 Control Application

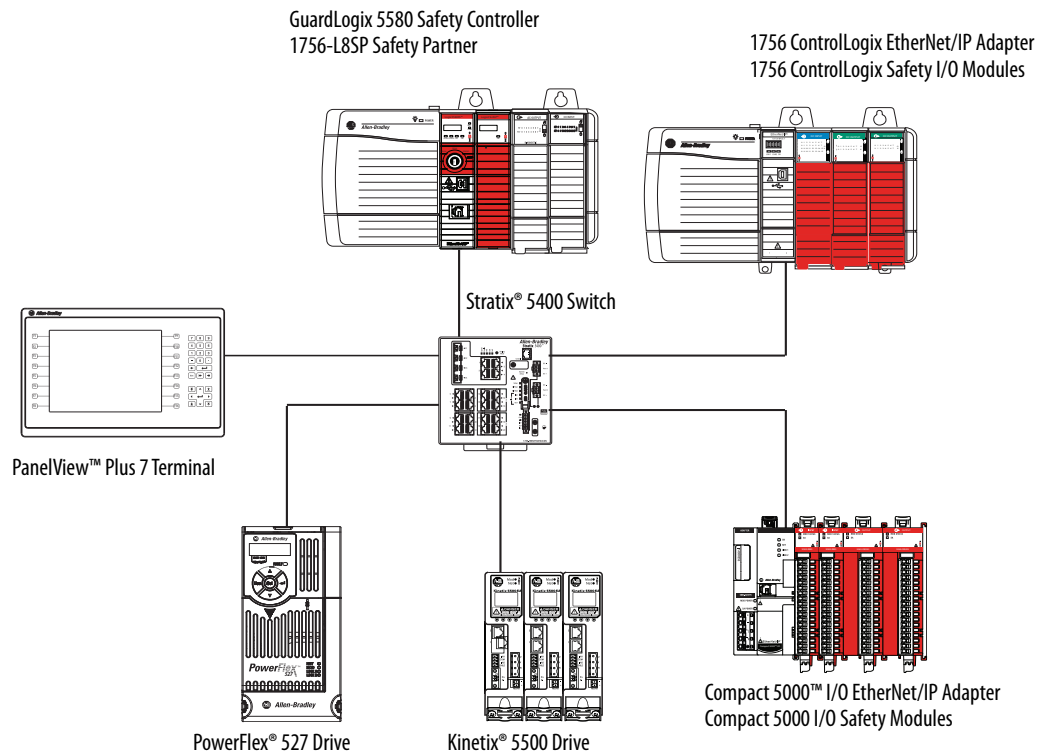

Ownership

Every standard or safety I/O module in a GuardLogix 5580 control system must be owned by a controller, also known as the owner-controller.

1756 ControlLogix digital safety I/O modules digital input modules can only have one owner-controller. When a 1756 ControlLogix Digital Safety I/O Module is used in a GuardLogix 5580 control system, the owner-controller performs the following:

- Stores configuration data for every module that it owns.
- Sends the I/O module configuration data to define module behavior and begin operation in the control system.

Each I/O module must continuously maintain communication with its owner-controller during normal operation.

Construct a System

Before you install and use your module, you must do the following:

- Install and ground a 1756 chassis and power supply. To install these products, refer to the publications listed in [Additional Resources on page 8](#).
- Order and receive an RTB and its components for your application. RTBs are not included with your module purchase.

1756 ControlLogix 16-point Sinking Safety Input Module (1756-IB16S) uses these RTBs:

- 1756-TBCHS Cage-clamp removable terminal block with standard housing, 36-pin
- 1756-TBS6HS Spring-clamp removable terminal block with standard housing, 36-pin
- 1756-TBES Extended-depth terminal block housing. Requires the underlying connector.

For how to assemble and wire the RTB, see the 1756 ControlLogix 16-point Sinking Safety Input Module Installation Instructions, publication [1756-IN079](#).

The 1756 ControlLogix 8-point Safety Bipolar/Sourcing Output Module (1756-OBV8S) uses these RTBs:

- 1756-TBNHS Cage-clamp removable terminal block with standard housing, 20-pin
- 1756-TBSHS Spring-clamp removable terminal block with standard housing, 20-pin
- 1756-TBES Extended-depth terminal block housing. Requires the underlying connector.

For how to assemble and wire the RTB, see the 1756 ControlLogix 8-point Safety Bipolar/Sourcing Output Module Installation Instructions, publication [1756-IN081](#).

Local I/O Modules

Complete the following:

1. Install a GuardLogix 5580 controller.
2. Install the modules.

Remote I/O Modules

Complete the following:

1. Install a GuardLogix 5580 controller.
2. Install an EtherNet/IP network.
3. Connect the controller to the network.
4. Install a 1756 ControlLogix EtherNet/IP adapter in the remote chassis.
5. Connect the adapter to the network.
6. Install the 1756 ControlLogix digital safety I/O modules.

For information on how to install compatible controllers, adapters, and I/O modules, see the publications that are listed in [Additional Resources on page 8](#).

Configure the Modules

You must create a Logix Designer application project for the controller that owns the 1756 ControlLogix digital safety I/O modules. The project includes module configuration data for the module.

The Logix Designer application transfers the project to the owner-controller during the program download. Data is then transferred to the I/O modules either across the backplane or over an EtherNet/IP network.

The I/O modules can operate immediately after receiving the configuration data.

-
- IMPORTANT** This section shows some Logix Designer application screens; it is not a complete description of how to configure a module.
- For more information on how to use the Logix Designer application to configure 1756 ControlLogix digital safety I/O modules, see Chapter 5, [Configure and Replace Safety Modules on page 77](#).
-

Connections with 1756 ControlLogix Digital Safety I/O Modules

During module configuration, you must define the module. Among the Module Definition parameters with 1756 ControlLogix digital I/O modules, you must choose a connection type for the module. A connection is a real-time data transfer link between the owner-controller and the module that occupies the slot that the configuration references.

When you download module configuration to a controller, the controller attempts to establish a connection to each module in the configuration.

Because part of module configuration includes a slot number in the local or remote system, the owner-controller checks for the presence of a module there. If a module is detected, the owner-controller sends the configuration. One of the following occurs:

- If the configuration is appropriate to the module detected, a connection is made and operation begins.
- If the configuration is not appropriate to the module detected, the data is rejected and the Logix Designer application indicates that an error occurred.

The configuration can be inappropriate for many reasons. For example, a mismatch in electronic keying that prevents normal operation.

The owner-controller monitors its connection with a module. Any break in the connection, for example, the loss of power to the system, causes a fault. The Logix Designer application monitors the fault status tags to indicate when a fault occurs on a module.

During module configuration, you must define the module. Among the Module Definition parameters with 1756 ControlLogix digital safety I/O modules, you must choose how module is configured.

The choice depends on whether the project is downloaded to the controller that owns the module configuration, that is, the owner-controller, or to a controller that is listening to input modules in a project.

A real-time data transfer link is established between the controller and the module that occupies the slot that the configuration references.

When you download module configuration to a controller, the controller attempts to establish a connection to each module in the configuration.

Configured By Options Available with the 1756 ControlLogix Digital Safety I/O Modules

The Configured By choice determines what data is exchanged between the owner-controller and the module. These are example Module Definition dialog boxes, and available Connection choices, for the 1756-IB16S and 1756-OBV8S safety modules.

1756-IB16S Module

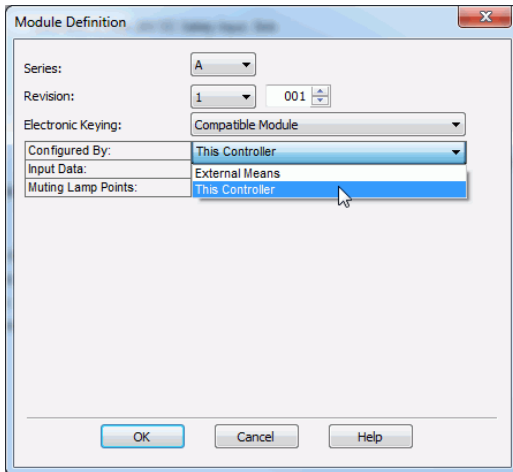

1756-OBV8S Module

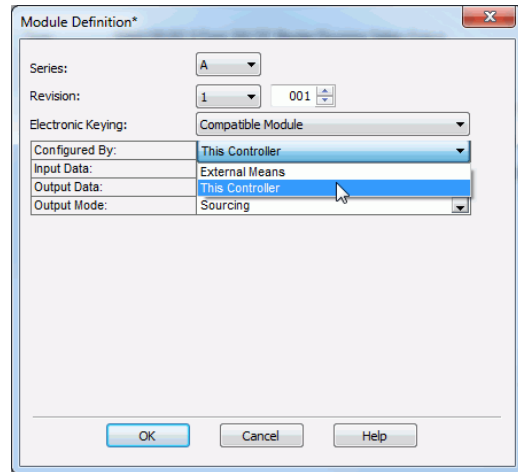

[Table 3](#) describes the connection types that you can use with the 1756-IB16S and 1756-OBV8S safety modules.

Table 3 - Configured By Choices - 1756-IB16S and 1756-OBV8S Safety Modules

Configured By Choice	Description	
	1756-IB16S Safety Input Module	1756-OBV8S Safety Output Module
This Controller	The module returns the following to the owner-controller: <ul style="list-style-type: none"> • General fault data • Safety input data 	The module returns the following to the owner-controller: <ul style="list-style-type: none"> • General fault data • Safety input data • Safety output data When you choose This Controller, you must define the output mode that the module uses, that is, sourcing or bipolar output mode.
External Means	When the External Means option is chosen, another controller listens to the data exchanged with the owner-controller. That is, it receives Safety input data. A controller with this option does not write configuration for the module. For more information on External Means, see External Means on page 35 .	

Data Types Available with 1756 ControlLogix Digital Safety I/O Modules

On the Module Definition dialog box for 1756 ControlLogix digital safety I/O modules, you must configure data type parameters.

[Table 4](#) describes the available data type choices based on module type.

Table 4 - 1756 ControlLogix Digital Safety I/O Modules - Data Types

Catalog Number	Supported Data Types	Data Type Choices
1756-IB16S	Input Data	Safety Data Safety Packed Data
1756-OBV8S	Input Data	Safety Data Safety Packed Data
	Output Data	Safety Data Safety Packed Data

For information on the Data Types, see [Module Tag Definitions on page 113](#).

Output Mode Available with 1756-OBV8S Safety Output Module

The Module Definition for the 1756-OBV8S safety output module includes the Output Mode parameter. This parameter defines whether the module is operating in Sourcing or Bipolar mode.

IMPORTANT If the Configured By parameter is External Means, the Output Mode parameter is disabled. It is automatically set to None.

For more information on the Module Definition parameters that are available with 1756 ControlLogix digital safety I/O modules, see the Logix Designer application.

Requested Packet Interval

The Requested Packet Interval (RPI) is a configurable parameter that defines a rate at which the owner-controller and the module exchange data.

You set the RPI value during initial module configuration and can adjust it as necessary after module operation has begun. Valid RPI values for 1756 ControlLogix Digital Safety I/O Modules are 2...500 ms.

-
- IMPORTANT** You can change the RPI while the project is online. If you change the RPI while the project is online, however, the connection to the module is closed and reopened in one of the following ways:
- You inhibit the connection to the module, change the RPI value, and uninhibit the connection.
 - You change the RPI value. In this case, the connection is closed and reopened immediately after you apply the change to the module configuration.
-

Connection Reaction Time Limit With 1756 ControlLogix Digital Safety I/O Modules

With 1756 ControlLogix digital safety I/O modules, the Connection Reaction Time Limit configuration affects the module RPI.

The Connection Reaction Time Limit defines the maximum time that is allowed between valid safety packets on the associated connection. If the Max Network Delay exceeds the Connection Reaction Time Limit, a connection fault occurs.

By default, the Connection Reaction Time Limit is four times the RPI.

Use the default values for Timeout Multiplier (2) and Network Delay Multiplier (200). The Network Delay Multiplier value is in terms of percentage. Thus, 200 means 200%.

-
- IMPORTANT** To determine what is appropriate, analyze each safety channel. The default Timeout Multiplier of 2 and Network Delay Multiplier of 200 creates a worst-case input connection reaction time limit of 4 times the RPI, and an output connection reaction time limit of 3 times the RPI.
- Changes to these parameters must be approved only after a thorough review by a safety administrator.
-

For more information on how to specify RPI rates, see [page 85](#).

Also see:

- GuardLogix 5580 and Compact GuardLogix 5380 Controller Systems Safety Reference Manual, publication [1756-RM012](#).
- Logix 5000 Controllers Design Considerations Reference Manual, publication [1756-RM094](#).

Connection Over an EtherNet/IP Network

When you configure a remote safety module, you must configure the Connection over EtherNet/IP parameter in the configuration for the remote adapter that connects the I/O modules to the network. The configuration choice dictates how input data is transmitted over the network.

The 1756 ControlLogix digital safety I/O modules use one of the following methods to transmit data:

- Multicast - Data is sent to all network devices.
- Unicast - Data is sent to one or more controllers depending on module configuration.

Unicast is the default setting.

Input Module Operation

Logix 5000 controllers do not poll the safety input modules for input data.

The data exchange process between the input modules and the controller differs based on whether the module is a local I/O module or remote I/O module.

Local 1756 ControlLogix Digital Safety Input Modules

Local 1756 ControlLogix digital safety input modules broadcast their input data, that is, channel and status data, to the system backplane at the time that is defined in the RPI.

At the RPI, the following events occur.

1. The local input module scans its channels for input data.
2. The module sends the data to the system backplane.
3. The controller receives the data immediately.

IMPORTANT 1756 ControlLogix digital safety input modules cannot trigger events.

Remote 1756 ControlLogix Digital Safety Input Modules

Remote digital safety input modules broadcast their input data to the backplane at the time that is defined in the RPI. The input data consists of channel and status data.

At the RPI, the following events occur.

1. The remote input module scans its channels for input data.
2. The module sends the data to the remote system backplane.
3. The EtherNet/IP adapter sends the data over the EtherNet/IP network.
4. One of the following:
 - When a GuardLogix 5580 or Compact GuardLogix 5380 controller is directly connected to the EtherNet/IP network, it receives the input data immediately.
 - When a GuardLogix 5580 controller is connected to the EtherNet/IP network through another communication module, the module sends the data to its backplane and the controller receives it.

Output Module Operation

Logix 5000 controllers send data to safety output modules at the RPI. The RPI defines when the controller sends data to an output module and when the module echoes data.

IMPORTANT You **cannot use Immediate Output (IOT) instructions** in safety programs.

At the RPI, not only does the controller send data to the output module, but also the output module sends data to the controller. For example, the output module sends an indication of the channel data quality.

IMPORTANT The RPI for a safety output module is the Safety Task period. Safety output data is sent at the completion of the Safety Task scan.

The data exchange process between safety output modules and a controller differs based on whether the module is a local I/O module or remote I/O module.

Local Safety Output Modules

Local safety output modules receive output data from a controller and send data to the controller. The data exchange occurs over the system backplane.

Controller to Local Output Module Data Transmission

The controller broadcasts data to its local backplane at the RPI.

IMPORTANT You **cannot use Immediate Output (IOT) instructions** in safety programs.

The safety outputs are sent to the safety output module at the end of safety task.

The safety output RPI is set by the safety task period.

These events occur when the controller sends data to a local safety output I/O module.

1. The controller sends data to system backplane at the RPI.
2. The local output module receives the data from the system backplane and behaves as dictated by its configuration.

Local Output Module to Controller Data Transmission

When a local safety output module receives new data and the requested data value is present on the RTB, the output module sends output readback status to the controller. The data value corresponds to the signal present at its terminals.

In addition to the output readback, the output module sends other data to the controller at the RPI. For example, the module alerts the controller if a short circuit condition exists on the module.

The following events occur when a local safety output module sends data to the controller at the RPI.

1. The module sends the data to the system backplane.
2. The controller receives the data immediately.

Remote Safety Output Modules

Remote safety output modules receive output data from a controller and send data to the controller. The data exchange occurs over an EtherNet/IP network.

Controller to Remote Output Module Data Transmission

The controller broadcasts data to its local backplane at the RPI. The owner-controller does not depend on the program scan to complete to send data.

These events occur when the controller sends data to a digital safety output module.

1. Data is sent in one of the following ways:
 - If the controller is directly connected to the EtherNet/IP network, it broadcasts data to the network.
In this case, skip to [step 3](#).
 - If the controller is connected to the EtherNet/IP network via a communication module, the controller transmits the data to the backplane.
In this case, proceed to [step 2](#).
2. The EtherNet/IP communication module transmits the data to the EtherNet/IP network.
3. The EtherNet/IP adapter in the remote system receives the data from the network and transmits it to the system backplane.
4. The remote output module receives the data from the backplane and behaves as dictated by its configuration.

Remote Output Module to Controller Data Transmission

When a safety output module receives new data and the requested data value is present on the RTB, the output module sends output readback status to the controller. The data value corresponds to the signal present at its terminals.

In addition to the output readback, the output module sends other data to the controller at the RPI. For example, the module alerts the controller if a short circuit condition exists on the module.

The following events occur when a remote safety output module sends data to the controller at the RPI.

1. The module sends the data to the remote system backplane.
2. The EtherNet/IP adapter in the system sends the data over the EtherNet/IP network.
3. One of the following:
 - If the controller is directly connected to the EtherNet/IP network, it receives the input data from the network without need for a communication module.
 - If the controller is connected to the EtherNet/IP network through another communication module, the module transmits the data to its backplane and the controller receives it.

External Means

Any controller in the system can listen to the data from an I/O module. An owner-controller, as described in [Ownership on page 24](#), exchanges data with I/O modules.

Controllers that do not own a module but must listen to data from it use the following on the Module Definition dialog box:

- 1756 ControlLogix digital safety I/O modules - Configured By = External Means.

In this case, the 'listening' controller can only listen to input data. The listening controller does not own the module configuration or exchange other data with the module.

When the module is configured by External Means, you can disable the module configuration signature. This disables the configuration validation check when connections are made.

During the I/O configuration process, you can specify an External Means connection. For more information on Connection options, see [Module Definition on page 84](#).

IMPORTANT Remember the following:

- If a controller uses External Means, the connection can be Multicast or Unicast.
 - Once a module has been configured by the owner-controller, External Means connections can be created and maintained regardless of owner state.
-

Protected Operations

To maintain the secure operation of your safety I/O modules, operations that can disrupt module operation are restricted based on the module operating mode.

[Table 5](#) describes the restrictions.

Table 5 - Protected Operations on safety I/O modules

Current Module Operation	Activity						
	Firmware Update Request	Module Reset Request	Connection Request	Configuration Change	Connection or Data Format Change	Electronic Keying Change	RPI Change
Connection not running	Accepted						
Connection running	Rejected		Accepted ⁽¹⁾	Accepted ⁽²⁾	Not allowed ⁽³⁾		Accepted ⁽⁴⁾
Firmware update is in process	Rejected						

(1) Only requests for Listen Only connections are accepted.

(2) Configuration change is accepted in the following scenarios:

- Changes are made in the Module Properties dialog box and you click Apply.
- Changes are made in the Configuration tags and you send a Reconfigure Module MSG to the module.

(3) The difference between Rejected and Not allowed is that rejected activities can be attempted in the Logix Designer application but do not take effect. The activities that are not allowed, that is, attempts to change the Connection or Data Format used, do not occur in the Logix Designer application.

For example, if you attempt to reset a module that is connected to the owner-controller, the Logix Designer application executes the request and alerts you that it was rejected. If you attempt to change the data format on a module that is connected to an owner-controller, the Logix Designer application does not execute the attempted change. The application only alerts you that the change is not allowed. In the case, if the change is attempted online, the Module Definition dialog box field that changes the data format is disabled.

(4) The change occurs after the connection is closed and reopened. You can close and reopen the connection in the following ways:

- Change the project while it is offline and download the updated project before going online again.
- Change the project while it is online and click Apply or OK in the Module Properties dialog box. In this case, before the change is made, a dialog box alerts you of the ramifications before the change is made.

Features Common to 1756 ControlLogix Digital Safety I/O Modules

Topic	Page
Input Module Compatibility	38
Output Module Compatibility	38
Software Configurable	39
Module Data Quality Reporting	40
Fault and Status Reporting	41
Module Inhibiting	41
Electronic Keying	43
Module Firmware	44
Producer/Consumer Communication	44

This chapter describes features that are common to 1756 ControlLogix® Digital Safety I/O Modules modules unless otherwise noted.

Some features are supported on all I/O modules and other features are specific to module types. The differences are indicated in feature descriptions.

Input Module Compatibility Digital safety input modules interface to sensing devices and detect whether they are On or Off.

These input modules convert DC On/Off signals from user devices to appropriate logic level for use in the controller. Typical input devices include:

- Proximity switches
- Limit switches
- Selector switches
- Float switches
- Push button switches

When you design systems with a digital safety input module, consider these factors:

- Voltage necessary for your application
- Current leakage
- Whether you need a solid-state device
- Whether your application uses sinking or sourcing wiring

Output Module Compatibility

You can use a digital safety output module to drive output devices. Typical devices compatible with these output modules include:

- Motor starters
- Solenoids
- Indicators

When you design systems with a digital safety output module, follow these guidelines:

- Make sure that the output modules can supply the necessary surge and continuous current for proper operation.
- Make sure that the surge and continuous current are not exceeded. Damage to the module could result.

When you size output loads, refer to the documentation supplied with the output device for the surge and continuous current necessary to operate the device.

Software Configurable

You use the Studio 5000 Logix Designer® application to configure the module, monitor system operation, and troubleshoot issues. You can also use the Logix Designer application to retrieve this information from any module in the system:

- Serial number
- Firmware revision information
- Product code
- Vendor
- Error and fault information
- Diagnostic information

By minimizing the need for tasks, such as setting hardware switches and jumpers, the software makes module configuration easier.

Module Data Quality Reporting

The digital safety I/O modules indicate the quality of channel data that is returned to the owner-controller. Data quality represents accuracy. Levels of data quality are reported via module input tags.

These input tags indicate the level of data quality.

IMPORTANT Once the condition that causes the Fault or Uncertain tag to change to 1 is removed, the tag automatically resets to 0. The Logix Designer application controls the tags. You cannot change the status of the tags.

Keep in mind that in some system configurations, the tag is not reset immediately after the condition is removed. The tag typically resets after a small delay.

- I.Ptxx.Fault - This tag indicates that the reported channel data is inaccurate and cannot be trusted for use in your application. Do not use the reported channel data for control.

If the tag is set to 1, you cannot trust the data reported. You must troubleshoot the module to correct the cause of the inaccuracy.

Example causes of inaccurate data include:

- Field Power Loss condition (output modules)
- Short Circuit condition (output modules)

We recommend that you troubleshoot the module for the typical causes first.

- I.Ptxx.Uncertain - This tag indicates that the reported channel data can be inaccurate but the degree of inaccuracy is unknown. We recommend that you do not use the reported channel data for control.

If the module sets this tag to 1, you know that the data can be inaccurate. You must troubleshoot the module to discover what degree of inaccuracy exists.

Example causes of uncertain data include:

- Module is operating outside its designed operating range
- Data is under manual or override control

IMPORTANT We strongly recommend that you monitor the tags in your program to make sure that the application is operating as expected with accurate channel input data.

Fault and Status Reporting

The digital safety I/O modules report fault and status data along with channel data. Fault and status data is reported in these ways:

- Logix Designer application
- Module status indicators
- I/O status indicators

IMPORTANT Do not use the module status indicators or I/O status indicators on 1756 ControlLogix digital safety I/O modules for safety operations.

For more information on fault and status reporting, see:

- Input modules - [Fault and Status Reporting on page 54](#)
- Output modules - [Fault and Status Reporting on page 71](#)
- Appendix A, [Troubleshoot Your Module on page 103](#)

Module Inhibiting

Module inhibiting lets you indefinitely suspend a connection, including Listen Only connections, between an owner-controller and an I/O module without removing the module from the configuration. This process lets you temporarily disable a module, such as to perform maintenance.

IMPORTANT You cannot inhibit a connection when the controller is safety-locked or a safety signature exists for the controller.

You can use module inhibiting in these ways:

- You write a configuration for an I/O module but inhibit the module to help prevent it from communicating with the owner-controller. The owner does not establish a connection and the configuration is not sent to the module until the connection is uninhibited.
- In your application, a controller already owns a module, has downloaded the configuration to the module, and is exchanging data over the connection between the devices.

In this case, you can inhibit the module and the connection to the module does not exist.

IMPORTANT Whenever you inhibit an output module that is ProgMode enabled, it enters Program mode, and all outputs change to the state configured for Program mode.

For example, if an output module is configured so that the state of the outputs transition to zero during Program mode, whenever that module is inhibited, outputs transition to zero.

You can use module inhibiting in these instances:

- You want to update an I/O module, for example, update the module firmware revision. Use this procedure.
 - a. Inhibit the module.
 - b. Perform the update.
 - c. Uninhibit the module.
- You use a program that includes a module that you do not physically possess yet. You do not want the controller to look for a module that does not yet exist. In this case, you can inhibit the module in your program until it physically resides in the proper slot.

You can inhibit the connection to a 1756 ControlLogix digital safety I/O module on the Connection category of the Module Properties dialog box.

To see where to inhibit a connection, see [Connection Category on page 85](#).

Electronic Keying

Electronic Keying reduces the possibility that you use the wrong device in a control system. It compares the device that is defined in your project to the installed device. If keying fails, a fault occurs. These attributes are compared.

Attribute	Description
Vendor	The device manufacturer.
Device Type	The general type of the product, for example, digital I/O module.
Product Code	The specific type of the product. The Product Code maps to a catalog number.
Major Revision	A number that represents the functional capabilities of a device.
Minor Revision	A number that represents behavior changes in the device.

The following Electronic Keying options are available.

Keying Option	Description
Compatible Module	This is the default keying option. Compatible Module lets the installed device accept the key of the device that is defined in the project when the installed device can emulate the defined device. With Compatible Module, you can typically replace a device with another device that has the following characteristics: <ul style="list-style-type: none"> • Same catalog number • Same or higher Major Revision • Minor Revision as follows: <ul style="list-style-type: none"> – If the Major Revision is the same, the Minor Revision must be the same or higher. – If the Major Revision is higher, the Minor Revision can be any number.
Exact Match	Indicates that all keying attributes must match to establish communication. If any attribute does not match precisely, communication with the device does not occur. This is a suitable keying option for safety applications.

Carefully consider the implications of each keying option when selecting one.

IMPORTANT Changing Electronic Keying parameters online interrupts connections to the device and any devices that are connected through the device. Connections from other controllers can also be broken.

If an I/O connection to a device is interrupted, the result can be a loss of data.

More Information

For more detailed information on Electronic Keying, see Electronic Keying in Logix 5000™ Control Systems Application Technique, publication [LOGIX-AT001](#).

Module Firmware

The digital safety I/O modules are manufactured with module firmware installed. If updated module firmware revisions are available in the future, you can update the firmware.

If the module is configured for Exact Match, the controller checks to make sure that the module has the correct firmware revision.

Updated firmware revisions are made available for various reasons, for example, to correct an anomaly that existed in previous module firmware revisions.

IMPORTANT Verify that the module firmware revisions for the 1756 ControlLogix digital safety I/O modules that you use are correct before commissioning your system.

You access updated firmware files at the Rockwell Automation® Product Compatibility and Download Center (PCDC). The PCDC is available at:

<https://compatibility.rockwellautomation.com/Pages/home.aspx>

Only download firmware and access product release notes from the Rockwell Automation® PCDC.

Do not download firmware from non-Rockwell Automation sites.

Producer/Consumer Communication

Digital safety I/O modules use the Producer/Consumer communication model to produce data without a controller polling them first. The modules produce the data, and the owner-controller (and controllers with a Listen Only connection to the module) can consume the data.

When an input module produces data, the controllers can consume the data simultaneously. Simultaneous data consumption minimizes the need for one controller to send the data to other controllers.

1756-IB16S Input Module Features

Topic	Page
Overview	45
Safety Application Suitability Level	46
Use Test Output with a Safety Input	47
Single-channel Point Operation Type	49
Safety Input Fault Reset	50
Safety Input Delay Time	50
Data Transfer at RPI	52
Module Health Diagnostic	52
Fault and Status Reporting	54
Field Power Loss Detection	55
Short Circuit Protection	56

Overview

This section describes features that are available on the 1756-IB16S module.

The following apply to the safety inputs:

- You can connect safety devices, such as Emergency Stop Push Button, gate switches, and safety light curtains.
- Evaluate an input signal, that is, input data, in single-channel mode or dual-channel mode.
- An external wiring short circuit check is possible when inputs are wired in combination with test outputs. The module must be wired in combination with test outputs when this function is used.
- Independently adjustable on and off delays are available per channel.
- Diagnostics.
- Safety input points are configured as:
 - Not Used
 - Safety
 - Safety Pulse Test

The following apply to the test outputs:

- Test outputs can be configured as:
 - Not Used
 - Power Supply
 - Pulse Test
- Separate test outputs are provided for short circuit detection of a safety input (or inputs).
- Can supply 24V DC power to devices, such as safety sensors.
- Test output rating (TO) 200 mA @ 18...32V DC

Safety Application Suitability Level

[Table 6](#) describes the safety application suitability levels for the 1756-IB16S module.

Table 6 - Safety Application Suitability for 1756-IB16S

Suitability Level	Conditions	Notes
Safety applications that are rated up to and including SIL CL3, PLd, Cat. 2 as defined in IEC 61508, IEC 61511, IEC 62061, and ISO 13849-1	The safety function uses single-channel mode. <ul style="list-style-type: none"> • Module channel Point Mode is Safety Pulse Test. 	Consider the following: <ul style="list-style-type: none"> • Single-channel mode and dual-channel mode, as stated in this table, refer to the number of channels used in the safety function. • The 1756-IB16S module is capable of being a SIL CL3/PLe/Cat. 4 subsystem (SRP/CS) when either a single-channel or dual-channel safety device is wired to the input channels. • The channel mode type, that is, single or dual, affects Performance Level and Category. You can use the modules in SIL CL3 applications regardless of channel mode type.
Safety applications that are rated up to and including SIL CL3, PLd, Cat. 3 as defined in IEC 61508, IEC 61511, IEC 62061, and ISO 13849-1	The safety function uses dual-channel mode ⁽¹⁾ . <ul style="list-style-type: none"> • Module channel Point mode is Safety. 	<ul style="list-style-type: none"> • The determining factor to whether a 1756 ControlLogix® I/O safety module resides in a SIL CL3, PLe, Cat. 4 safety application is that the overall safety architecture be a dual-channel system. • To achieve SIL CL3 single-channel, the sensor that is used must be SIL CL 3 single-channel as well. • The requirement that Point Mode be Safety Pulse Test assumes that only the safety modules provide diagnostics to a specific Suitability Level.
Safety applications that are rated up to, and including, SIL CL3, PLe, Cat. 4 as defined in IEC 61508, IEC 61511, IEC 62061, and ISO 13849-1.	The safety function uses dual-channel mode. <ul style="list-style-type: none"> • Module channel Point Mode is Safety Pulse Test. The safety function uses dual-channel mode. <ul style="list-style-type: none"> • Module channel Point mode is Safety. • Use shredded cable or cable trunk to separate channel wiring to mitigate short circuit faults. 	<ul style="list-style-type: none"> • The larger safety system within which the safety modules reside can provide the diagnostics necessary to achieve the stated Suitability Level without the requirement that Point Mode be Safety Pulse Test.

(1) You cannot configure the module for dual-channel operation via the Logix Designer application module properties dialog box. You use dual-channel safety instructions in the Safety Task to provide cross monitoring.

Use Test Output with a Safety Input

A test output can be used in combination with a safety input for short circuit and cross-channel fault detection. In this case, Point Mode must be Safety Pulse Test. Safety input pairs must be associated with different Test Output sources.

When pulse testing is used, the only test source available for each channel is the test output to the left as shown on the wiring diagram.

IMPORTANT Because of the pre-configured relationships between test outputs and input channels, wiring a dual channel device to input channels 0 and 8 is not supported if pulse testing is required, the same holds true for 1/9, 2/10, 3/11, 4/12, 5/13, 6/14, 7/15.

TIP The test output also can be configured as a power supply to source 24V DC to an external device, for example, a light curtain.

Figure 6 - 1756-IB16S Module - Input Connected to Test Output

Channel Connections

The diagram shows devices that are connected to safety input channel 0 and test output channel 0. You can connect devices to all 16 channels.

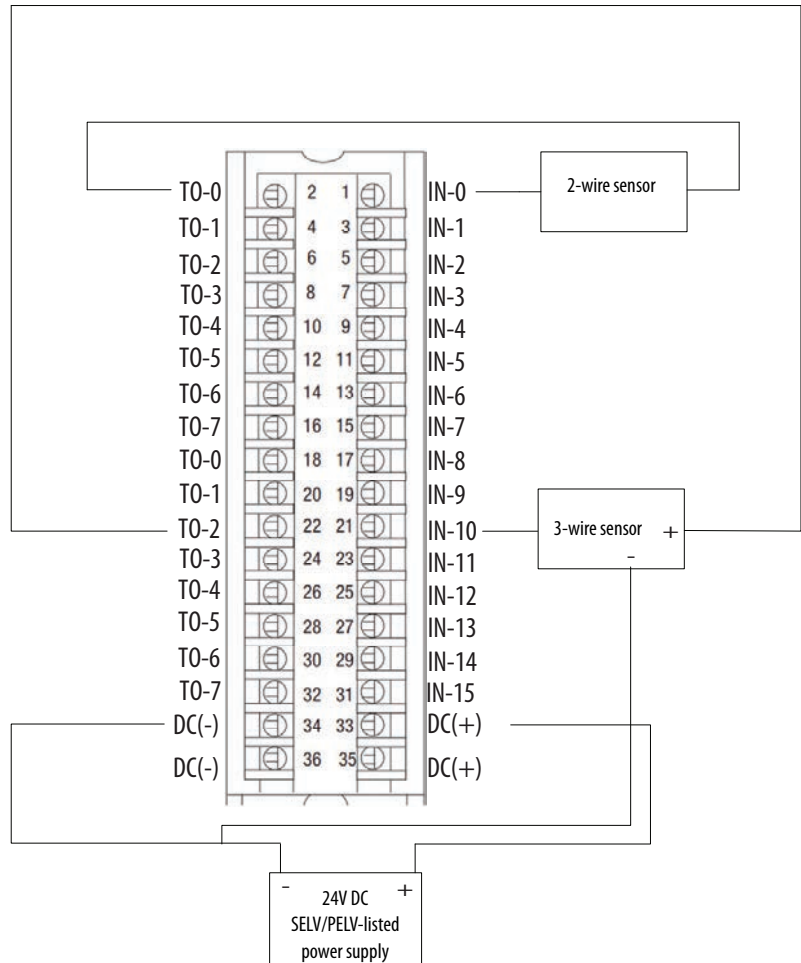
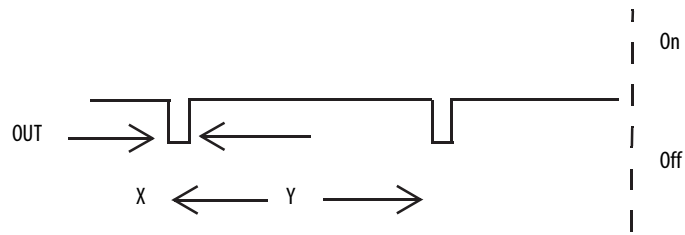

Figure 7 - 1756-IB16S Test Pulse in a Cycle



On the 1756-IB16S module, the test pulse width (X) is less than 600 μ s; the test pulse period (Y) is less than 100 ms.

When the external input contact is closed, a test pulse is output from the test output terminal to diagnose the field wiring and input circuitry. By using this function, short-circuits between inputs and 24V power, and between input signal lines can be detected.

Figure 8 - Short Circuit Between Input Signal Lines

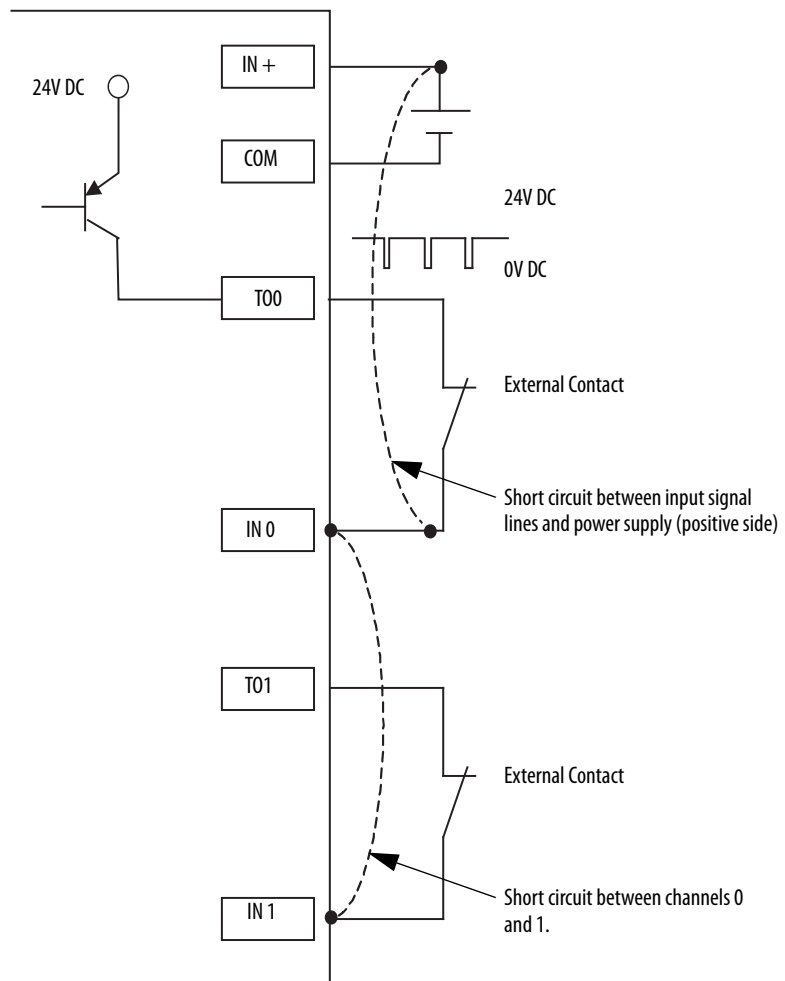

Single-channel Point Operation Type

If an error is detected on the input channel, Safety Input Data and Safety Input Status turn off.

For information on how using single-channel Point Operation Type with a 1756-IB16S module affects the safety application suitability level, see [Table 6 on page 46](#).

Figure 9 - Normal Operation and Fault Detection (Not to Scale)

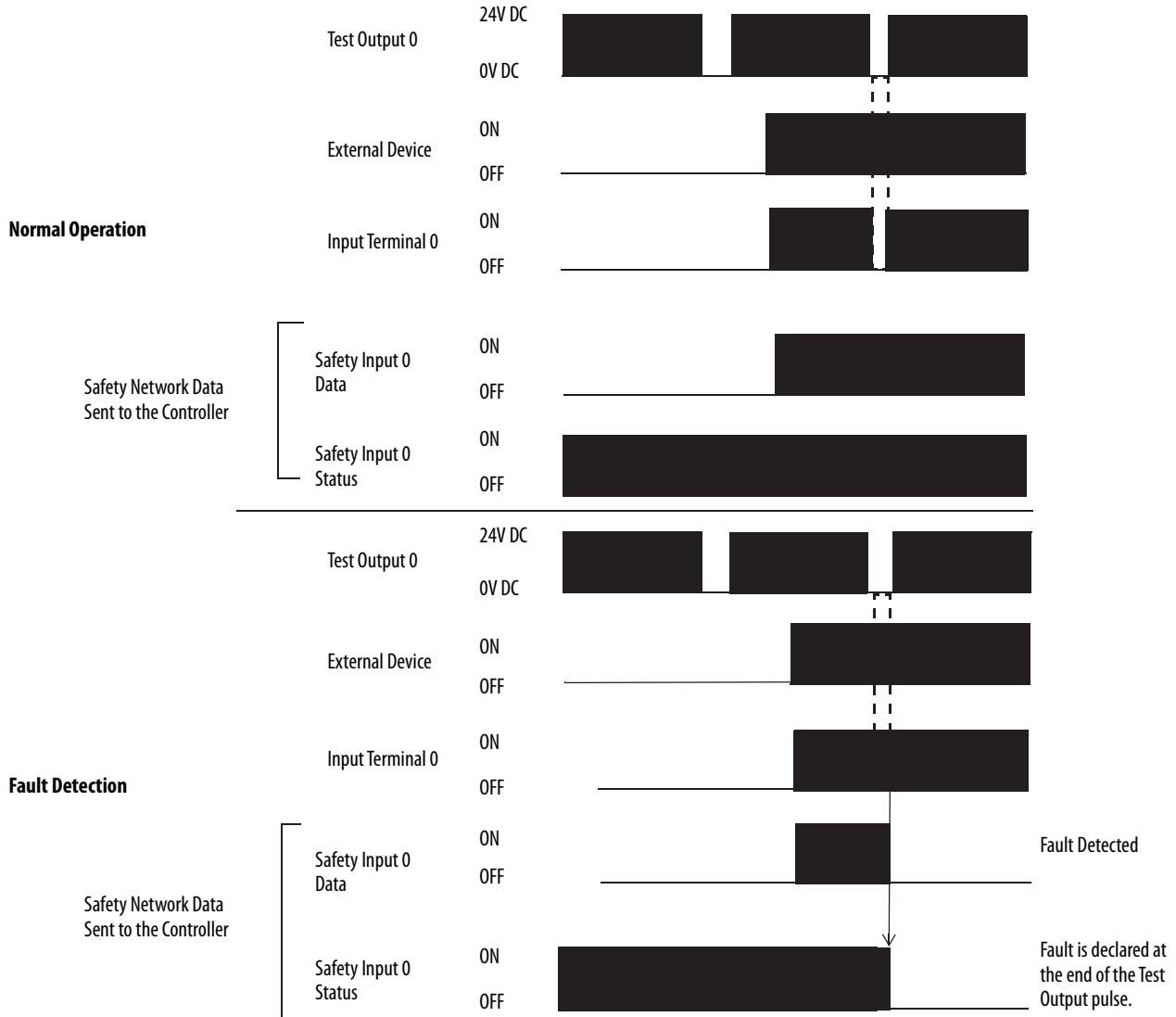

Safety Input Fault Reset

The I/O channel supports a module-level user-configurable 'Latch Fault until reset via output tag' mode and recovers from these faults:

- Field Power Off Detection
- Safety Input Short Circuit

'Latch Fault until reset via output tag' mode is Enabled

When Latch Fault... mode is Enabled, the I/O channel holds safety input fault indications until it checks that the fault is removed. If the fault is removed, the channel clears the fault status only upon detecting that the ResetFault in its consume assembly channel sees a rising edge.

'Latch Fault until reset via output tag' mode is Disabled

When Latch Fault... mode is Disabled (default), the I/O channel holds safety input fault indications for 1 second until it checks if the fault is removed. If the fault is removed, the channel clears the fault status only upon detecting the safety input is low on the screw. If not, the channel continues to check if the fault is removed.

Safety Input Delay Time

You can increase the time that it takes for an input point to transition from On to Off and Off to On on the 1756-IB16S module. The increase in time is a delay of the signal from the module to the controller.

The RPI defines a rate at which the owner-controller and the module exchange data (2...500 ms). For example, if you set the RPI at 10 ms and use an input delay time of 2 ms, it could take up to 12 ms for a signal change to be seen at the controller.

An increase in the time it takes to transition from one state to another improves noise immunity within a signal.

To set the Input Delay Time on the 1756-IB16S module, see [Edit the 1756-IB16S Module Configuration Categories on page 88](#).

Off to On Delay

An input signal is treated as Logic 0 during the Off to On delay time after the rising edge of the input contact.

The input turns on only if the input contact remains on after the Off to On delay time has elapsed. This setting help prevent rapid changes of the input data due to contact bounce.

You can delay the Off to On transition by the following times:

- 0 ms
- 1 ms
- 2 ms
- 5 ms
- 10 ms
- 20 ms
- 50 ms

Figure 10 - Off to On Delay

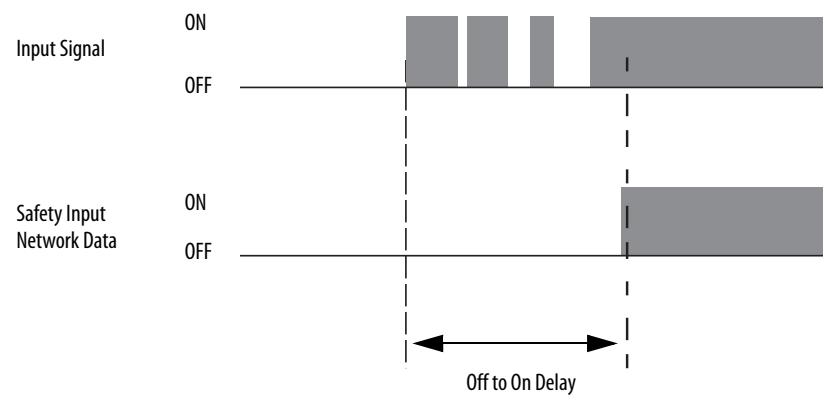

On to Off Delay

An input signal is treated as Logic 1 during the On to Off delay time after the falling edge of the input contact.

The input turns off only if the input contact remains off after the On to Off delay time has elapsed. This setting helps to prevent rapid changes of the input data due to contact bounce.

You can delay the On to Off transition by the following times:

- 0 ms
- 1 ms
- 2 ms
- 5 ms
- 10 ms
- 20 ms
- 50 ms

Figure 11 - On to Off Delay

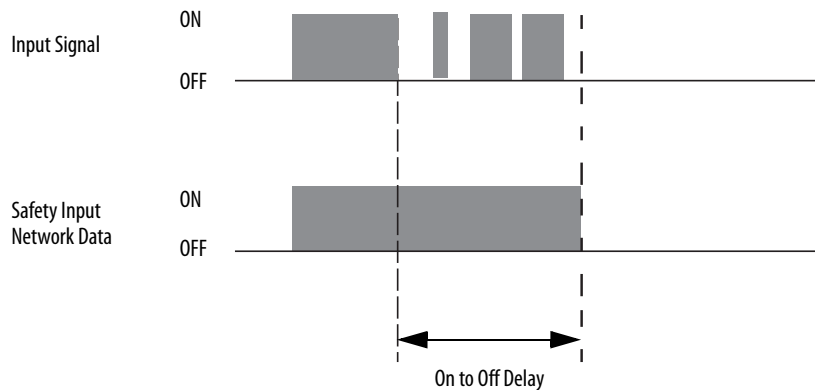

Data Transfer at RPI

The safety input module always sends data to the owner-controller at the RPI. You set the RPI on the Connection page of the Module Properties dialog box in the Logix Designer application.

Module Health Diagnostic

Every I/O module has a status indicator on the front of the module that indicates module health.

For more information on status indicators, see Appendix A, [Troubleshoot Your Module on page 103](#).

Point Diagnostics

Point diagnostics provide information on an individual point basis. For example, you can check individual input points and test output points on a 1756-IB16S safety input module for the presence of a Short Circuit condition.

[Figure 12](#) shows how to access output point diagnostics on the 1756-IB16S module and the diagnostics dialog box.

Figure 12 - Point Diagnostics

The screenshot shows the 'Module Properties: Local:2 (1756-IB16S 1.001)' window. On the left is a tree view with 'Input Points' selected. The main area displays a table of input points. The 'Diagnostics' column for point 00 is circled. Below the table is a dropdown menu for 'Latch Fault until reset via output tag' set to 'Disabled'. An 'OK' button is visible at the bottom right of the main window. A 'PT00 Diagnostics' dialog box is open, showing the following data:

Parameter	Value
Fault Exists:	Yes
Data Uncertain:	No
Field Power:	Present
Field Power On:	1969-12-31-19:00:03.281_128_320(UTC-05:00)
Field Power Off:	1969-12-31-19:00:02.755_108_230(UTC-05:00)
Short Circuit Fault:	No
Fault Timestamp for Short Circuit Fault:	None
Internal Fault:	No
Fault Timestamp for Internal Fault:	None
Over Temperature Fault:	No
Fault Timestamp for Over Temperature:	None
Critical Temperature Fault:	No
Fault Timestamp for Critical Temperature Fault:	None

The dialog box also contains 'OK' and 'Help' buttons at the bottom.

Fault and Status Reporting

The input modules send fault and status data with channel data to the owner and listening controllers. The data is returned via module tags that you can monitor in your Logix Designer application.

With some exceptions, the digital input modules provide the fault and data status in a point-centric format. The tag names that include Ptxx represent point-centric data in the table. The xx represents the point number.

[Table 7](#) lists tags that are used on 1756-IB16S module.

IMPORTANT For more information on the valid values for each tag, see Appendix B, [Module Tag Definitions on page 113](#).

Table 7 - 1756-IB16S Module - Fault and Data Status

Data Type	Tag Name	Triggering Event That Sets
Fault	ConnectionFaulted ⁽¹⁾	The owner-controller loses its connection to the module.
	Ptxx.Fault	The point data quality is bad or the channel is set to Not Used.
	Ptxx.ShortCircuit	A short circuit condition exists on the point.
	Testxx.Fault	The point data quality is bad or the channel is set to Not Used.
	Testxx.ShortCircuit	A short circuit condition exists on the test point.
	Testxx.FieldPowerOff	A field power lost condition exists on the test point.
Status	RunMode	The module is in Run Mode.
	DiagnosticActive	Indicates if any diagnostics are active or if the prognostics threshold is reached.
	DiagnosticSequenceCount	The count increments each time that a diagnostic condition is detected or removed.
	Ptxx.Data	The data currently at the point.
	Ptxx.Uncertain	The point data can be imperfect because an Over temperature or Critical Temperature condition exists.
	Ptxx.Status	The point state transitions from normal to faulted or faulted to normal.
	Testxx.Readback	A 24V DC power is present at the test output.
	Testxx.Uncertain	The test point data can be imperfect.
Testxx.Status	The test point state transitions from normal to faulted or faulted to normal.	

(1) This tag provides module-wide data and affects all channels simultaneously.

For more information on fault reporting, see Appendix A, [Troubleshoot Your Module on page 103](#).

Field Power Loss Detection

The Field Power Loss Detection feature monitors for the loss of field-side power.

When power is lost, the module detects the loss of field power and faults. As a result, fault data is sent to the controller. Keep in mind that all points on the module fault when a field power is lost.

[Table 8](#) describes what happens when a field power loss **condition is detected**.

Table 8 - Field Power Loss Detection - Condition Detected

Test Output Behavior	Tag Value	Diagnostic Value	I/O Status Indicator State	SA Status Indicator
<ul style="list-style-type: none"> Faults Turns off 	<ul style="list-style-type: none"> I.Testxx.FieldPowerOff tag = 1 I.Testxx.Fault tag = 1 	FieldPowerOff diagnostic = 1	Solid red	Off

To correct the issue, you must reapply field power to the module.

[Table 9](#) describes what happens when a **field power is restored** and the error latch time, if set, has expired.

Table 9 - Field Power Loss Detection - Power Restored

Test Output Behavior	Tag Value	Diagnostic Value	I/O Status Indicator State	SA Status Indicator
Restarts in its commanded state.	<ul style="list-style-type: none"> I.Testxx.FieldPowerOff tag = 0 I.Testxx.Fault tag = 0 	FieldPowerOff diagnostic = 0	Off	Steady green

IMPORTANT The module can require up to 1 second to complete the recovery in addition to the Input Error Latch Time.

Field Power Loss Detection has a corresponding tag that can be examined in the user program if a fault occurs. For information on modules, see Appendix B, [Module Tag Definitions on page 113](#).

You can also monitor a point for the presence of a field power loss via the diagnostics that are available in the Module Properties dialog box in Logix Designer application.

Short Circuit Protection

Short Circuit Protection helps to prevent damage to a test output that can result when more current is present at the output than it can handle. The diagnostic is supported on all module outputs.

[Table 10](#) describes what happens when a short circuit **condition is detected**.

Table 10 - Short Circuit Protection - Condition Detected

Test Output Behavior	Tag Value	Diagnostic Value	I/O Status Indicator State
<ul style="list-style-type: none"> • Faults • Turns off 	I.Testxx.ShortCircuit tag = 1 I.Testxx.Fault tag = 1	Short Circuit diagnostic = 1	Flashing red

To correct the issue, remove the short.

[Table 11](#) describes what happens when the short circuit **condition is corrected**.

Table 11 - Short Circuit Protection - Condition Corrected

Test Output Behavior	Tag Value	Diagnostic Value	I/O Status Indicator State
Restarts in its commanded state.	I.Testxx.ShortCircuit tag = 0 I.Testxx.Fault tag = 0	Short Circuit diagnostic = 0	Turns off if there is no longer a load that is connected to the output.

For more information on the maximum current that you can apply to an output, see the ControlLogix I/O Modules Specifications Technical Data, publication [1756-TD002](#).

Test Output Recovery After Overload or Short Circuit to Ground Condition

[Table 12](#) describes test output recovery after overload or short circuit to ground conditions occur.

Table 12 - Test Output Recovery - 1756 ControlLogix Digital Safety Input Modules

Cause of Fault	Module Operating Conditions	Correction	Recovery Time
Overload Condition	<ul style="list-style-type: none"> • Test Output Point Mode - Pulse Test, Power Supply • Test Output Data tag = 1. • Overload current ≥ 0.7 A. 	Remove the load from the test output point.	After the condition is corrected, and the test output is returned to the safe state, it recovers in whichever of these times is higher: <ul style="list-style-type: none"> • 10 seconds • Input Error Latch Time - This time is set on the Input Points category of the Module Properties dialog box. To see where to set the Input Error Latch Time, go to page 88 .
Short Circuit to Ground Condition	<ul style="list-style-type: none"> • Test Output Point Mode - Pulse Test, Power Supply • Test Output Data tag = 1. • Test output is connected directly to ground. 	One of the following: <ul style="list-style-type: none"> • If the Point Mode for the test output is Pulse Test or Power Supply when the Short Circuit condition is detected, the condition can be corrected but you cannot set the test output to a safe state. 	

1756-OBV8S Output Module Features

Topic	Page
Overview	58
Safety Application Suitability Level	59
Safety Output with Test Pulse	60
Single-channel Point Operation Type	61
Dual-channel Point Operation Type	62
Safety Output Fault Reset	63
Fault and Status Reporting	64
Module Health Diagnostics	64
Field Power Loss Detection	66
No Load Detection	67
Short Circuit Protection	68
Thermal Shutoff	70
Fault and Status Reporting	71
Configurable Channel-level Output State in Program Mode or Fault Mode	71
Connection Fault Handling	72
Forcing	73

This chapter describes features that are supported on the 1756-OVB8S output module.

Overview

The 1756-OBV8S is a safety output module that uses eight safety outputs. You use the outputs in one of the following ways:

- Sourcing/sinking outputs in Bipolar Output mode
- Sourcing outputs in Sourcing Output mode.
- Solid-state outputs
- Single-channel mode uses one output signal, that is, data from an output channel, to provide control.

IMPORTANT Single-channel mode is only certified for functional safety applications with process safety times greater than or equal to 200 ms; or, applications with demand rates less than or equal to 3 demand per minute.

- Dual-channel mode uses two output signals, that is, data from two output channels to provide redundant control.
- Safety outputs can be pulse-tested to detect field wiring short-circuits to 24V DC.
- The 1756-OBV8S module follows the mode of the Safety Task, which can be different than the mode of the controller.

When the safety task encounters a nonrecoverable safety fault, a standard major recoverable fault is also logged, and the controller proceeds to execute the controller fault handler, if one exists. If the controller fault handler handles this fault, then the standard tasks continue to run, even though the safety task remains faulted.

If a recoverable fault occurs in the safety application, the system can halt the execution of the safety task, depending upon whether or not the fault is handled by Program Fault Routines in the safety application. If the recoverable safety fault is not handled, a standard major recoverable fault is also logged, and the controller proceeds to execute the controller fault handler, if one exists. If the controller fault handler handles this fault, then the standard tasks continue to run, even though the safety task remains faulted.

In these scenarios, the 1756-OBV8S module follows the Safety Task and will be in Program Mode/Communications Fault mode even though the controller is still in Run mode.

For information on Safety Faults, see the ControlLogix® 5580 and GuardLogix® 5580 Controllers User Manual, publication [1756-UM543](#).

IMPORTANT If there is a fault on a separate safety output on the same module, the module could switch off all outputs.

Safety Application Suitability Level

[Table 13](#) describes the safety application suitability levels for the 1756-OBV8S module.

Table 13 - Safety Application Suitability for 1756-OBV8S Module

Suitability Level	Conditions	Notes
Safety applications that are rated up to, and including, SIL CL3, PLd, Cat. 2 as defined in IEC 61508, IEC 61511, IEC 62061, and ISO 13849-1.	<p>The safety function uses single-channel mode.</p> <ul style="list-style-type: none"> Module Output Mode is Sourcing Module channel Point Operation Type is SINGLE Module channel Point mode is Safety Pulse test. <p>The safety function uses single-channel mode</p> <ul style="list-style-type: none"> Module Output Mode is bipolar Module channel Point mode is Safety Pulse test 	<p>Consider the following:</p> <ul style="list-style-type: none"> Single-channel mode refers to a single-channel actuator subsystem driven by one sourcing output channel configured for SINGLE, or one bipolar output channel configured for SINGLE. Dual channel mode refers to a dual channel actuator subsystem driven by two sourcing output channels configured for DUAL, or one bipolar output channel configured for SINGLE. The 1756-OBV8S module is capable of being a SIL CL3/PLe/Cat. 4 subsystem (SRP/CS) when either a single-channel or dual-channel safety device is wired to the output channels. The channel mode type, that is, single or dual, affects Category and Performance Level. You can use the modules in SIL CL3, PLe applications regardless of channel mode type.
Safety applications that are rated up to, and including, SIL CL3, PLe, Cat. 4 as defined in IEC 61508, IEC 61511, IEC 62061, and ISO 13849-1.	<p>The safety function uses dual-channel mode.</p> <ul style="list-style-type: none"> Module Output Mode is Sourcing Module Channel Point Operation Type is DUAL Module channel Point mode is Safety Pulse test. <p>The safety function uses dual-channel mode</p> <ul style="list-style-type: none"> Module Output Mode is bipolar Module channel Point mode is Safety Pulse test 	<ul style="list-style-type: none"> The determining factor to whether a 1756 ControlLogix digital safety I/O module resides in a SIL CL3, PLe, Cat. 4 safety application is that the overall safety architecture be a dual-channel system. The requirement that Point Mode be Safety Pulse Test assumes that only the safety modules provide diagnostics to a specific Suitability Level. <p>The larger safety system within which the safety I/O module resides can provide the diagnostics necessary to achieve the stated Suitability Level without the requirement that Point Mode be Safety Pulse Test.</p>

Safety Output with Test Pulse

When the safety output is on, the safety output can be configured to pulse test the safety output channel. By using this function, you can continuously test the ability of the safety output to remove power from the output terminals of the module.

If an error is detected, the safety output data and individual safety output status turn off.

Figure 13 - 1756-OBV8S Test Pulse in a Cycle

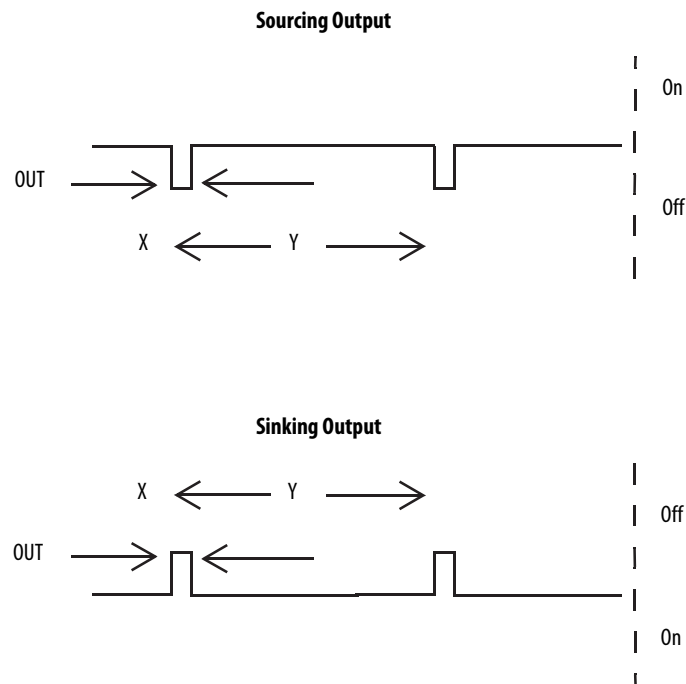

On the 1756-OBV8S module, the pulse width (X) is less than 750 μ s, and the pulse period (Y) is less than 96 ms.

TIP To help prevent the test pulse from causing the connected device to malfunction, pay careful attention to the input response time of the output device.

An open wire test and main switch pulse test can also generate a pulse on a safety output even in safety mode.

Two successive safety output pulses are required to determine if a short circuit fault exists. As a result, the effective pulse period is 192 ms, max.

Single-channel Point Operation Type

When the output channel is in the On state and without any faults, the safety outputs turned on. The status is normal. If a fault is detected on the output channel, the safety output data and individual safety output status turn off.

For information on how using single-channel Point Operation Type with a 1756-OBV8S module affects the safety application suitability level, see [Table 13 on page 59](#).

Figure 14 - 1756-OBV8S Single-channel Point Operation Type (Not to Scale)

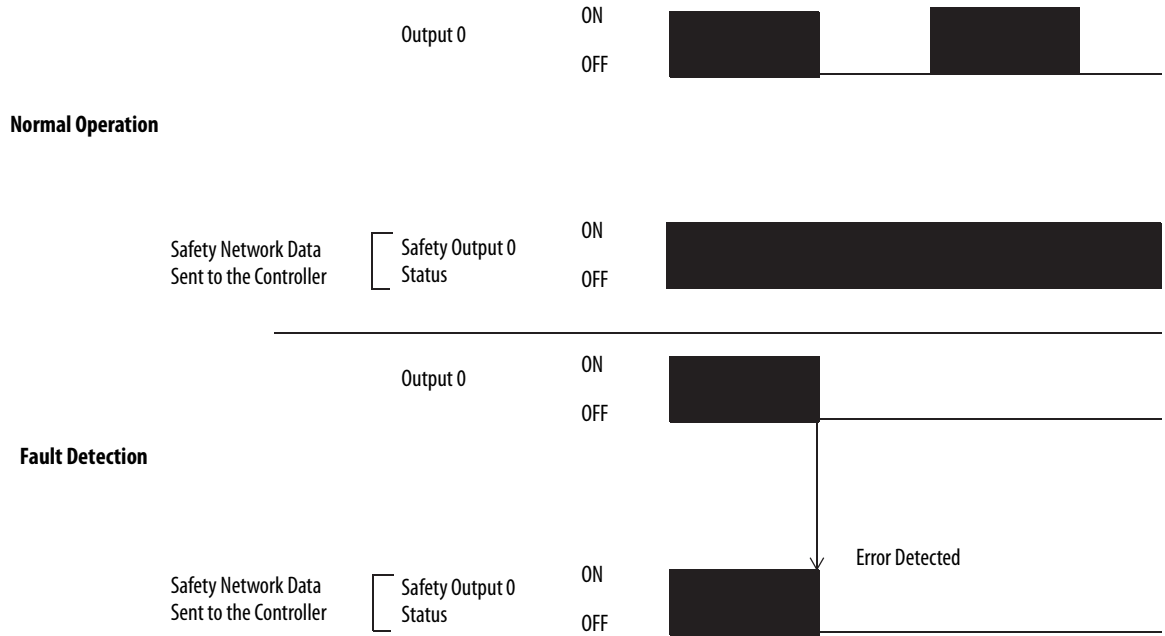

Dual-channel Point Operation Type

When dual-channel Point Operation Type is used, output channels function as connection pairs. Connection pairs are as follows:

- Channels 0 and 1
- Channels 2 and 3
- Channels 4 and 5
- Channels 6 and 7

IMPORTANT Dual-channel Point Operation Type is only available if the module is connected so that Output Mode is Sourcing.

When both output channels in a connection pair are in the On state and without any faults, the safety outputs are turned on.

For information on how to use dual-channel Point Operation Type with a 1756-OBV8S module affects the safety application suitability level, see [Table 13 on page 59](#).

Figure 15 - 1756-OBV8S Dual-channel Point Operation Type (Not to Scale)

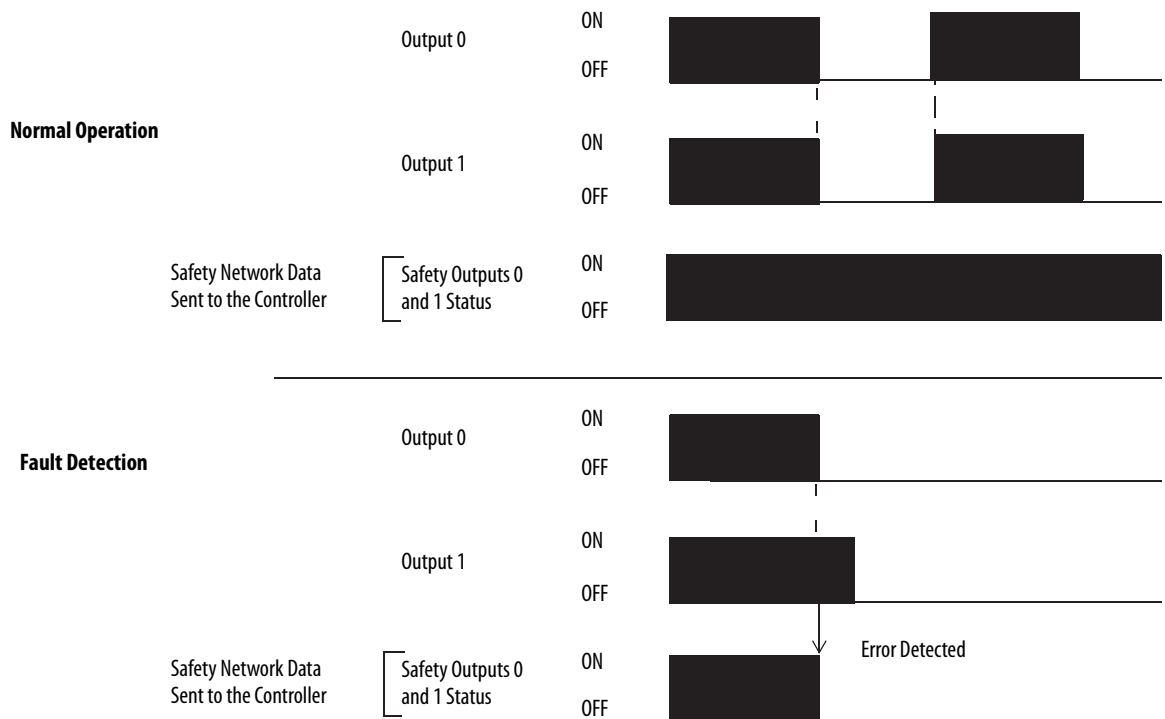

Safety Output Fault Reset

The I/O channel supports a module-level user-configurable 'Latch Fault until reset via output tag' mode and recovers from only these field faults:

- Field Power Off Detection
- Safety Output ShortCircuitGround
- Safety Output Overload

The recovery time is 1 second for Field Power Off, and 10 seconds for Short or Overload.

'Latch Fault until reset via output tag' mode is Enabled

When Latch Fault... mode is Enabled, the I/O channel holds safety output fault indications until it checks that the field fault is removed. If the field fault is removed, the channel clears the fault status only upon detecting that the ResetFault in its consume assembly channel sees a rising edge.

'Latch Fault until reset via output tag' mode is Disabled

When Latch Fault... mode is Disabled (default), the I/O channel holds safety output fault indications for 1 second until it checks if the field fault is removed. If the field fault is removed, the channel clears the fault status only upon detecting the consume data bit is low. The fault status will also be cleared by a module reset or power cycle or when "Output State During Program Mode and Communications Fault Mode" is configured to Off and any of the following conditions:

- Controller in Program mode
- Controller or Safety task fault
- Communications fault
- Module inhibit

After the channel clears the fault, the I/O indicator (red) turns off. The output data can now be controlled.

IMPORTANT If module outputs experience persistent high faults, consider cycling power to the module to clear the error.

Fault and Status Reporting

The 1756-OBV8S module multicasts fault and status data with channel data to the owner and listening controllers. The data is returned via module tags that you can monitor in your Logix Designer application.

For more information on how to use module tags to monitor fault and status reporting, see [Table 24 on page 71](#)

- Appendix A, [Troubleshoot Your Module on page 103](#).

Module Health Diagnostics

Each output module has a status indicator on the front of the module that indicates module health. For more information on module health diagnostics, see Appendix A, [Troubleshoot Your Module on page 103](#).

Point Diagnostics

Point diagnostics provide information on an individual point basis. For example, you can check individual points on a 1756-OBV8S safety output module for the presence of a Short Circuit condition.

To access output point diagnostics on the 1756-OBV8S module, click the Diagnostics button for the point.

Figure 16 - Point Diagnostics

Point	Point Operation Type	Point Mode	Output State During		Diagnostics
			Program Mode and Communications Fault Mode		
00	Single	Safety	Off		...
01	Single	Safety	Off		...
02	Single	Safety	Off		...
03	Single	Safety	Off		...
04	Single	Safety	Hold		...
05	Single	Safety	Hold		...
06	Single	Safety Pulse Test	Off		...
07	Single	Safety Pulse Test	Off		...

P100 Diagnostics ×

Fault Exists:	Yes
Data Uncertain:	No
Field Power:	None
Field Power On:	None
Field Power Off:	1969-12-31-19:00:03.253_854_710(UTC-05:00)
Short Circuit Fault:	No
Fault Timestamp for Short Circuit Fault:	None
Overload Fault:	No
Fault Timestamp for Overload Fault:	None
Short Circuit to Ground Fault:	No
Fault Timestamp for Short Circuit to Ground:	None
Internal Fault:	No
Fault Timestamp for Internal Fault:	None
Dual Channel Fault:	No
Fault Timestamp for Dual Channel Fault:	None
No Load Fault:	No
Fault Timestamp for No Load Fault:	None
Over Temperature Fault:	No
Fault Timestamp for Over Temperature Fault:	None
Critical Temperature Fault:	No
Fault Timestamp for Critical Temperature:	None

Field Power Loss Detection

The Field Power Loss Detection feature monitors for the loss of field power.

IMPORTANT The 1756-OBV8S module supports Field Power Loss Detection. The module receives field-side power via the DC power terminals on the module. When field-side power is lost on the 1756-OBV8S, it is lost from the DC power terminals. See [1756-OBV8S Module Wiring Diagrams on page 123](#).

Keep in mind that all points on the module fault when a field power is lost.

[Table 14](#) describes what happens when a field power loss **condition is detected**.

Table 14 - Field Power Loss Detection

Output Behavior	Tag Value	Diagnostic Value	I/O Status Indicator State
<ul style="list-style-type: none"> • Faults • Turns off 	One of the following: <ul style="list-style-type: none"> • I.Ptxx.FieldPowerOff tag = 1 • I.Ptxx.Fault tag = 1 	FieldPowerOff diagnostic = 1	<ul style="list-style-type: none"> • Solid red

To correct the issue, you must reapply field power to the output module.

[Table 15](#) describes what happens when a field power loss condition is resolved, and the module is recovered.

Table 15 - Field Power Loss Detection

Output Behavior	Tag Value	Diagnostic Value	I/O Status Indicator State
Restarts in its commanded state.	One of the following: <ul style="list-style-type: none"> • I.Ptxx.FieldPowerOff tag = 0 • I.Ptxx.Fault tag = 0 	FieldPowerOff diagnostic = 0	Off

IMPORTANT The module can require up to 2 seconds to complete the recovery.

Field Power Loss Detection has a corresponding tag that can be examined in the user program if a fault occurs. For information on module tags, see [Appendix B, Module Tag Definitions on page 113](#).

You can also monitor a point for the presence of a field power loss via the diagnostics that are available in the Module Properties dialog box in Logix Designer application.

IMPORTANT Keep in mind the following:

- For the 1756-OBV8S module, Field Power Loss detection is in regard to loss of field power on the DC power terminals, or the presence of Undervoltage or Overvoltage conditions on the DC Power bus.

No Load Detection

No Load Detection detects when a wire is disconnected from the output, or a missing load for each output point in the Off state.

No Load Detection is enabled by default on the 1756-OBV8S modules. You cannot configure it.

The module supports these minimum load currents:

- Safety output modules - The load detection current is ≥ 10 mA. For example, 2.4 k Ω at 24V DC.

In the On state, the module must be connected to a load that draws a minimum current equal to these values.

IMPORTANT An output must remain in the off state a minimum of 300 ms for an open load to be detected.

[Table 16](#) describes what happens when a No Load **condition is detected**.

Table 16 - No Load Detection - 1756-OBV8S Module

Condition	I/O Status Indicator State
No Load condition exists	<ul style="list-style-type: none"> • Flashing red if a No Load condition exists and the output is off. • Flashing red/yellow if a No Load condition already exists and the output is on. <p>IMPORTANT: A No Load condition is only detected when the output is off.</p>

[Table 17](#) describes what happens when a No Load **condition is corrected**.

Table 17 - No Load Detection - 1756-OBV8S Module

Condition	I/O Status Indicator State
No Load condition corrected	<ul style="list-style-type: none"> • Off if the output is off. • Steady yellow if the output is on.

You can monitor a point for the presence of a No Load condition via the diagnostics page that is available in the Module Properties dialog box in Logix Designer application.

Short Circuit Protection

Short Circuit Protection helps to prevent damage to the output that can result when more current is present at the output than it can handle.

[Table 18](#) describes what happens when a short circuit **condition is detected** on a 1756-OBV8S module.

Table 18 - Short Circuit Protection - 1756-OBV8S Module

Output Behavior	Tag Value	Module Properties Points Tab Diagnostic Value	I/O Status Indicator State
<ul style="list-style-type: none"> • Faults • Turns off 	One of the following: <ul style="list-style-type: none"> • If the output point is shorted to 24V DC, the I.Ptxx.ShortCircuit tag = 1. • If the output point is shorted to ground, no tags are changed. 	One of the following: <ul style="list-style-type: none"> • If the output point was shorted to 24V DC when the short circuit condition was detected, the Short Circuit diagnostic = Yes. • If the output point is shorted to ground when the short circuit condition was detected, the Short Circuit to Ground diagnostic = Yes. 	One of the following: <ul style="list-style-type: none"> • Flashes red if the output point is shorted to 24V DC. • Off if the output point is shorted to ground.

[Table 19](#) describes what happens when the short circuit condition is removed from a 1756-OBV8S module and the data is set to safe state, that is, the off state.

Table 19 - Short Circuit Protection - 1756-OBV8S Module

Output Behavior	Tag Value	Module Properties Points Tab Diagnostic Value	I/O Status Indicator State
Restarts in its commanded state	One of the following: <ul style="list-style-type: none"> • If the output point is shorted to 24V DC, the I.Ptxx.ShortCircuit tag = 0. • If the output point is shorted to ground, no tags are changed. 	One of the following: <ul style="list-style-type: none"> • If the output point was shorted to 24V DC when the short circuit condition was detected, the Short Circuit diagnostic = No. IMPORTANT: You must cycle power to the module to reset the diagnostic. • If the output point is shorted to ground when the short circuit condition was detected, the Short Circuit to Ground diagnostic = No 	Turns off if there is no longer a load that is connected to the output.

You can monitor a point for the presence of short circuit faults via the diagnostics page that is available in the Module Properties dialog box in Logix Designer application.

For more information on the maximum current that you can apply to an output, see the 1756 ControlLogix I/O Specifications Technical Data, publication [1756-TD002](#).

Other Conditions That Can Trigger the Short Circuit Diagnostic on the 1756-OBV8S Module

[Table 20](#) describes conditions that can trigger the Short Circuit diagnostic.

Table 20 - Conditions That Trigger Short Circuit Diagnostic

Conditions	Output Behavior	Tag and Diagnostic Combinations	I/O Status Indicator State
<ul style="list-style-type: none"> Output Mode - Sourcing Point Operation Type - Single Point Mode - Safety Pulse Test O.Ptxx.Data tag = 1 Output point is shorted to 24V DC. 	<ul style="list-style-type: none"> Faults Turns off 	<ul style="list-style-type: none"> I.Ptxx.ShortCircuit tag = 1 Short Circuit diagnostic = 1 I.Ptxx.Fault tag = 1 <p style="text-align: center;">or</p> <ul style="list-style-type: none"> I.Ptxx.Fault tag = 1 Internal Fault diagnostic = 1 <p>IMPORTANT: The tag and diagnostic combinations that are described occur on the faulted output point and all of its associated group points.</p>	The I/O status indicator for the faulted output point turns off.
These conditions exist on a pair of module outputs: <ul style="list-style-type: none"> Output Mode - Sourcing Point Operation Type - Dual Point Mode - Safety Pulse Test O.Ptxx.Data tag = 1 (Either output point in the pair) Output point is shorted to 24V DC (Either output point in the pair). 	<ul style="list-style-type: none"> Faults Turns off 	<ul style="list-style-type: none"> I.Ptxx.ShortCircuit tag = 1 I.Ptxx.Fault tag = 1 Short Circuit diagnostic = 1 Internal Fault diagnostic = 1 <p style="text-align: center;">or</p> <ul style="list-style-type: none"> I.Ptxx.Fault tag = 1 Internal Fault diagnostic = 1 <p>IMPORTANT: The tag and diagnostic combinations that are described occur on the faulted output point and all of its associated group points.</p>	
These conditions exist on a pair of module outputs: <ul style="list-style-type: none"> Output Mode - Sourcing Point Operation Type - Dual O.Ptxx.Data tag = 1 (Both output points in the pair) Output points are shorted to each other. 	<ul style="list-style-type: none"> Faults Turns off 	<ul style="list-style-type: none"> I.Ptxx.ShortCircuit tag = 1 (Both output points in the pair) Short Circuit diagnostic = 1 (Both output points in the pair) I.Ptxx.Fault tag = 1 <p style="text-align: center;">or</p> <ul style="list-style-type: none"> I.Ptxx.Fault tag = 1 (Faulted output point and all of its associated group points) Internal Fault diagnostic = 1 (Faulted output point and all of its associated group points) 	

When the conditions that trigger the diagnostics as described in [Table 20](#) are corrected, the results are the same as described in [Table 19 on page 68](#).

Output Recovery After Overload or Short Circuit to Ground Condition

[Table 21](#) describes test output recovery after overload or short circuit to ground conditions occur.

Table 21 - Output Recovery - 1756-OBV8S Module

Cause of Fault	Module Operating Conditions	Correction	Recovery Time
Overload Condition	<ul style="list-style-type: none"> Output Point Mode - Safety or Safety Pulse Test. Output Data tag = 1. Overload current $\geq 1.5 \text{ A}^{(1)}$ 	Remove the load from the output point.	See Safety Output Fault Reset on page 63 .
Short Circuit to Ground Condition	<ul style="list-style-type: none"> Output Point Mode - Safety or Safety Pulse Test. Output Data tag = 1. Output is connected directly to ground. 	Remove the output connection to ground and set the output to a safe state.	

(1) Do not use the module beyond the rated capacity of 1 A per channel for continuous operation. For ratings, see the 1756 ControlLogix I/O Specifications Technical Data pub [1756-TD002](#).

Thermal Shutoff

Thermal Shutoff helps prevent damage to the output that can result when an output gets hotter than it can handle.

This feature is **directly related to Short Circuit Protection** feature. The increased temperature at the output results from an excessive load at the output. That is, a load with high current is applied to the output. The high current heats the output beyond an acceptable temperature and the output turns off.

[Table 22](#) describes what happens when a thermal shutoff **condition is detected** on a 1756-OBV8S module.

Table 22 - Thermal Shutoff - 1756-OBV8S Module

Output Behavior	Tag Value	Diagnostic Value	I/O Status Indicator State
<ul style="list-style-type: none"> Faults Turns off 	One of the following: <ul style="list-style-type: none"> If the output point is shorted to 24V DC when the thermal shutoff condition occurred, the I.Ptxx.ShortCircuit tag = 1. If the output point is shorted to ground when the thermal shutoff condition occurred, there is no change to the tags. 	One of the following: <ul style="list-style-type: none"> If the output point is shorted to 24V DC when the thermal shutoff condition occurred, there is no change in the diagnostics. If the output point is shorted to ground when the thermal shutoff condition occurred, the ShortCircuitGround diagnostic = 1. 	Steady red

[Table 23](#) describes what happens when the thermal shutoff **condition is corrected** on a 1756-OBV8S module.

Table 23 - Thermal Shutoff - 1756-OBV8S Module

Output Behavior	Tag Value	Diagnostic Value	I/O Status Indicator State
Remains in the off state	I.Ptxx.ShortCircuit tag = 0	One of the following: <ul style="list-style-type: none"> If the output point was shorted to 24V DC when the thermal shutoff condition occurred, the Overload diagnostic = 0. IMPORTANT: You must cycle power to the module to reset the diagnostic. If the output point was shorted to ground when the thermal shutoff condition occurred, the ShortCircuitGround diagnostic = 0. 	Turns off if there is no longer a load that is connected to the output.

For more information on how to use the modules, see Appendix B, [Module Tag Definitions on page 113](#).

Fault and Status Reporting

The output modules multicast fault and status data with channel data to the owner and listening controllers. The data is returned via module tags that you can monitor in your Logix Designer application.

[Table 24](#) lists tags that are used on the 1756-OBV8S module.

IMPORTANT For more information on the valid values for each tag in [Table 24](#), see Appendix B, [Module Tag Definitions on page 113](#).

Table 24 - 1756-OBV8S - Fault and Data Status

Data Type	Tag Name	Triggering Event That Sets
Fault	ConnectionFaulted ⁽¹⁾	The owner-controller loses its connection to the module.
	Ptxx.Fault	The point data quality is bad or the channel is set to Not Used.
	Ptxx.ShortCircuit	A short circuit condition exists on the point.
	Ptxx.FieldPowerOff	A field power lost condition exists on the point.
Status	RunMode	The module is in Run Mode.
	DiagnosticActive	Indicates if any diagnostics are active or if the prognostics threshold is reached.
	DiagnosticSequenceCount	The count increments each time that a diagnostic condition is detected or removed.
	Ptxx.Readback	A 24V DC power source is connected to the output circuit.
	Ptxx.Uncertain	The point data can be imperfect.
	Ptxx.Status	The point state transitions from normal to faulted or faulted to normal.

(1) This tag provides module-wide data and affects all channels simultaneously.

For more information on fault reporting, see Appendix A, [Troubleshoot Your Module on page 103](#).

Configurable Channel-level Output State in Program Mode or Fault Mode

You can configure individual output channels to specific states when the module is in Program mode or Communications Fault mode. These output states are available:

- Off
- Hold



WARNING: The selection of "Hold" for Output State During Program Mode and Communications Fault Mode prevents the output point from going to the safe state, making the output point not suitable for a SIL or PL rated safety function. Set Output State During Program Mode and Communications Fault Mode to "Off" to allow points to go to safe state.

TÜV Rheinland has approved GuardLogix 5580 and Compact GuardLogix 5380 controller systems for use in safety-related applications where the de-energized state is always considered to be the safe state. You must ensure each configuration of the safety IO module is set for "Off" under the Output State During Program Mode and Communications Fault Mode selection to consider those output points as part of any equipment's safety function.

To see how to configure the output states in Program mode or Fault mode, see [Edit the 1756-OBV8S Module Points Category on page 90](#):

Connection Fault Handling

You can configure module behavior when a connection fault occurs, that is, the connection between the owner-controller and the output module breaks. You must define the immediate output behavior when the connection breaks.

Output Behavior Immediately After a Connection Fault



ATTENTION: If you change the Output state from OFF to HOLD during Program or Communication Fault modes, make sure this does not create an unsafe state of your safety system.

When the connection between an owner-controller and output module breaks, the output can behave in these ways, depending on how the Fault Mode parameter is configured:

- Turn off - Default
- Hold its last state

If you configure the output to hold its last state, the output remains at that state value until this occurs:

- The connection to the owner-controller is re-established.
- The output returns to normal operation, as defined in the module configuration.

Output State Once Connection is Re-established

Once the connection between the owner-controller and output module is re-established, the output resumes normal operation.

Forcing

Use a force to override data that your logic either uses or produces.

IMPORTANT When a safety signature exists, forcing safety I/O is not permitted in the safety portion of the application.

- Test and debug your logic.
- Temporarily maintain normal system operations when an input device has failed.

Use forces only as a temporary measure. They are not intended to be a permanent part of your application.

Make sure that you understand this before you use forces.



ATTENTION: Forcing can cause unexpected machine motion that could injure personnel. Before you use a force, determine how the force affects your machine or process and keep personnel away from the machine area.

- Enabling I/O or SFC forces causes your machine or process to go to another state or phase.
 - Removing forces can still leave forces in the enabled state.
 - If forces are enabled and you install a force, the new force immediately takes effect.
-

Enable Forces

For a force to take effect, you enable forces. You can only enable and disable forces at the controller level.

- You can enable I/O forces and SFC forces separately or simultaneously.
- You cannot enable or disable forces for a specific module, tag collection, or tag element.

Disable or Remove a Force

To stop the effect of a force and let your project execute as programmed, disable or remove the force.

- You can disable or remove I/O and SFC forces simultaneously or separately.
- When you remove a force on an alias tag, you also remove the force on the base tag.



ATTENTION: Changes to forces can cause unexpected machine motion that could injure personnel. Before you disable or remove forces, determine how the change affects your machine or process and keep personnel away from the machine area.

Check Force Status

Before you use a force, determine the status of forces for the controller.

The Online toolbar shows the status of forces. It shows the status of I/O forces and SFC forces separately.

To determine the status of this	Use any of these
I/O forces	<ul style="list-style-type: none"> • Online toolbar • GSV instruction
SFC forces	Online toolbar

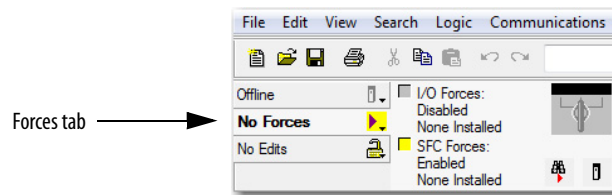

Forces Tab Status	Means
Enabled	<ul style="list-style-type: none"> • If the project contains any forces of this type, they are overriding your logic. • If you add a force of this type, the new force immediately takes effect
Disabled	Forces of this type are inactive. If the project contains any forces of this type, they are not overriding your logic.
Installed	At least one force of this type exists in the project.
None Installed	No forces of this type exist in the project.

GSV Instruction

This example shows how to use a GSV instruction to get the status of forces. For the purposes of this example, Force_Status is a DINT tag.

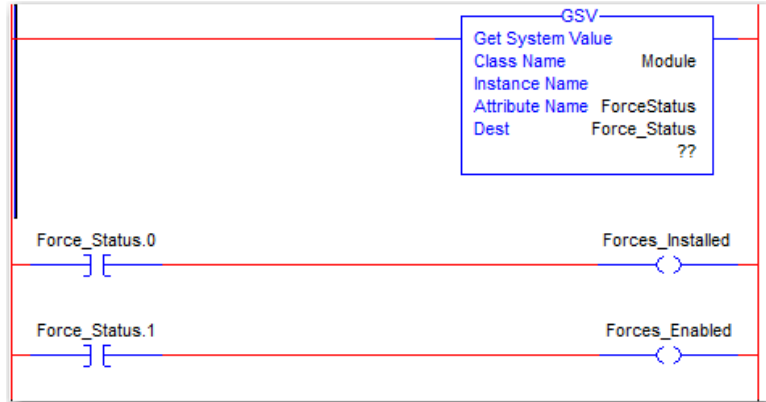

To determine this	Examine this bit	For this value
Forces are installed.	0	1
No forces are installed.	0	0
Forces are enabled.	1	1
Forces are disabled.	1	0

Notes:

Configure and Replace Safety Modules

Topic	Page
Create a New Module	78
Edit the Module Configuration Common Categories	82
Edit the 1756-IB16S Module Configuration Categories	88
Edit the 1756-OBV8S Module Points Category	90
View the Module Tags	92
Replace a Safety Module	93

This chapter describes how to configure your 1756 ControlLogix® Digital Safety I/O Modules in a Studio 5000 Logix Designer® application project.

IMPORTANT You must use the Logix Designer application, version 32 or greater with the modules.

By default, all safety input and output channels on 1756 ControlLogix Digital Safety I/O Modules are disabled. You must configure each point that is used in a Safety application.

This chapter does not explain the user-configurable parameters, or corresponding module features, in your Logix Designer application project.

For detailed information about module features, see the following:

- Chapter 2, [Features Common to 1756 ControlLogix Digital Safety I/O Modules on page 37](#)
- Chapter 3, [1756-IB16S Input Module Features on page 45](#)
- Chapter 4, [1756-OBV8S Output Module Features on page 57](#)

Create a New Module

The project must be offline to add safety modules to it.

You can create a new local or remote safety module. Local I/O modules are installed in the same system as the GuardLogix® 5580 controllers. Remote I/O modules are installed in a system that includes a 1756 ControlLogix EtherNet/IP™ adapter that connects to an EtherNet/IP network.

New Local Safety Module

To create a new local safety I/O module, complete these steps.

1. Create a Logix Designer application project.
2. Right-click the 1756 Backplane and choose New Module.

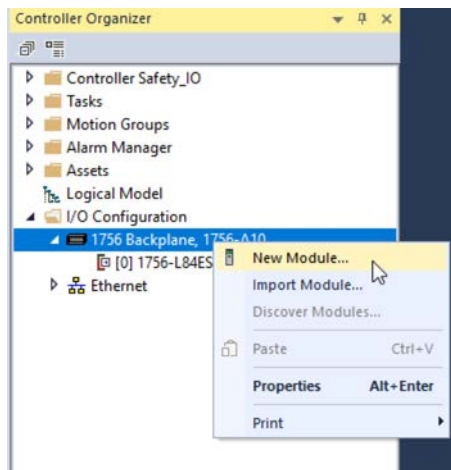

- At the Select Module Type window, click Create to add the discovered module to your project.

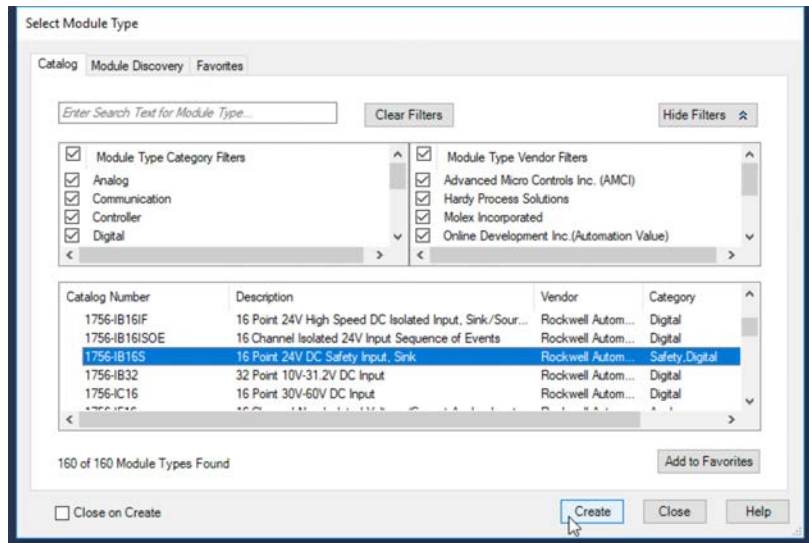

- At the New Module window, configure the module properties and click OK.

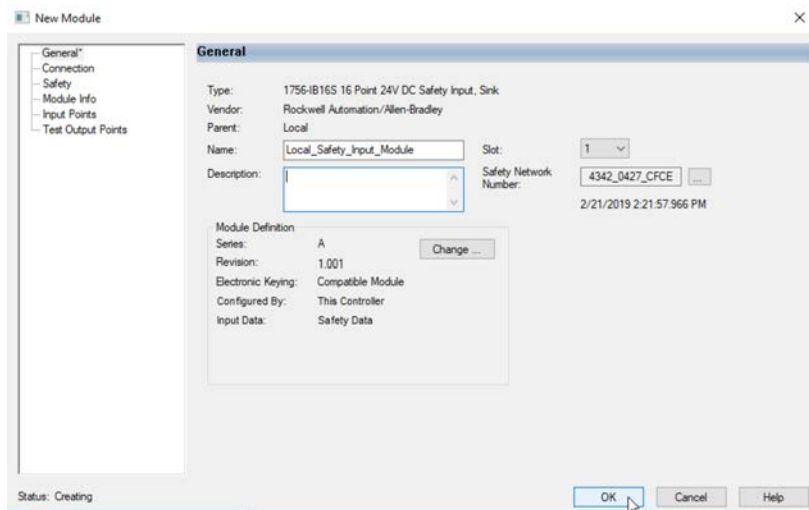

Follow the same steps to add additional local I/O modules.

New Remote I/O Module

To create a new remote safety I/O module, complete these steps.

1. Add a ControlLogix EtherNet/IP adapter to the project.
2. Right-click the EtherNet/IP adapter and choose New Module.

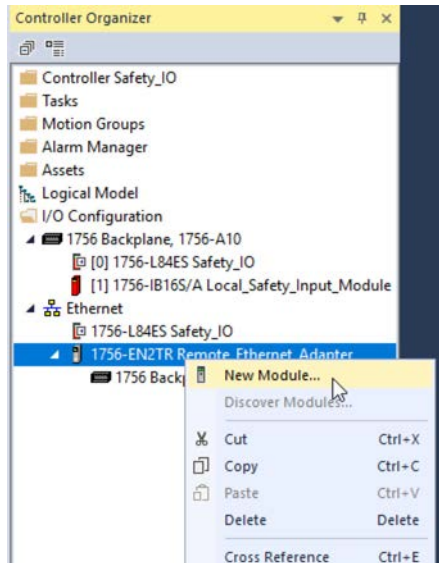

3. Select the module and click Create.

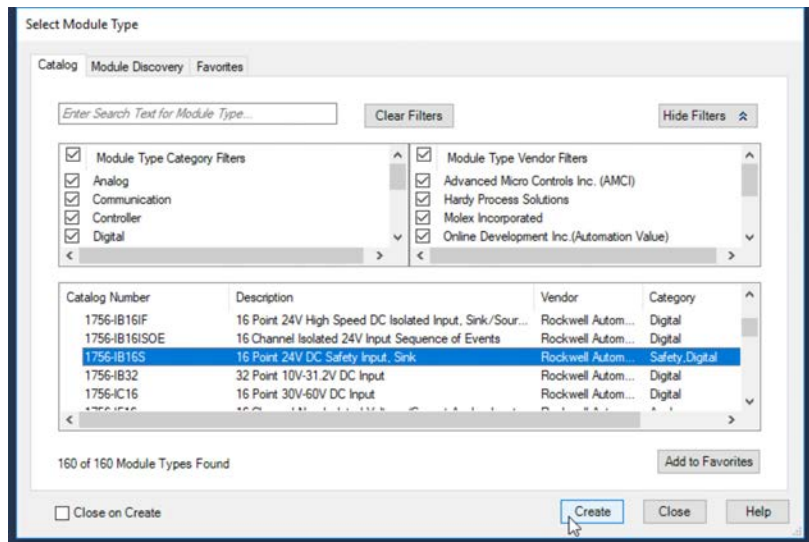

The New Module dialog box appears with a list of categories on the left side. The number and type of categories varies by module type.

4. You can click OK to use the default configuration as shown or edit the module configuration. The rest of this chapter describes how to edit module configuration categories.

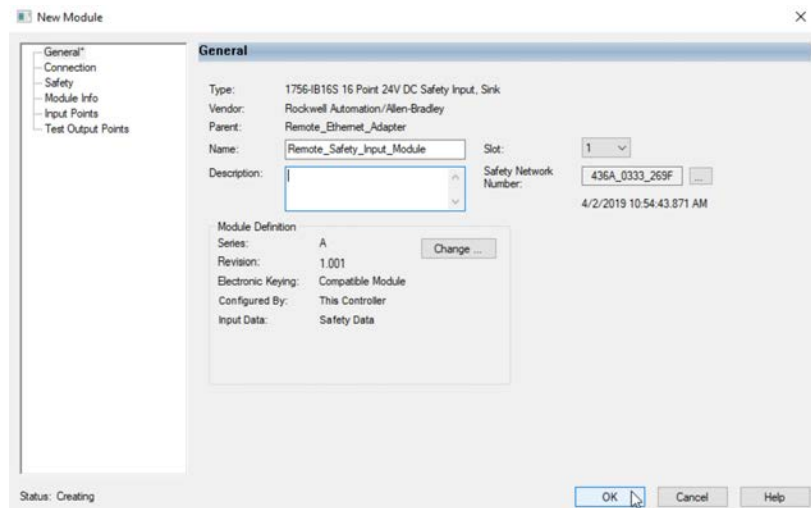

Follow the same steps to add additional remote I/O modules.

Edit the Module Configuration Common Categories

You click the category names in the New Module dialog box to view and change the configuration parameters. Before you edit the module configuration, consider the following:

- This chapter shows how to edit the module configuration when you add the module to the Logix Designer application project.

If you access the module configuration after it is added to the project, the dialog box is named Module Properties. The same categories are displayed as the categories displayed on the New Module dialog box.

- Some new module configuration categories apply to all 1756 ControlLogix digital safety I/O modules. Some categories are specific to the module type.

IMPORTANT By default, all safety input and output channels on 1756 ControlLogix digital safety I/O modules are disabled.

You must configure each point that is used in a Safety application.

The following categories apply to all 1756 ControlLogix digital safety I/O modules and are described in this section.

- [General Category](#)
- [Connection Category](#)
- [Safety Category](#)
- [Module Info Category](#)

General Category

The General category appears first when you create a module. The parameters in this category are the same for all 1756 ControlLogix digital safety I/O modules.

You use this category to complete the following tasks:

- Name the module.
- Assign a node number.
- Describe the module.
- Access the Module Definition.

Safety Network Number

The Logix Designer application automatically assigns a Safety Network Number (SNN) to safety modules as they are added to the project.

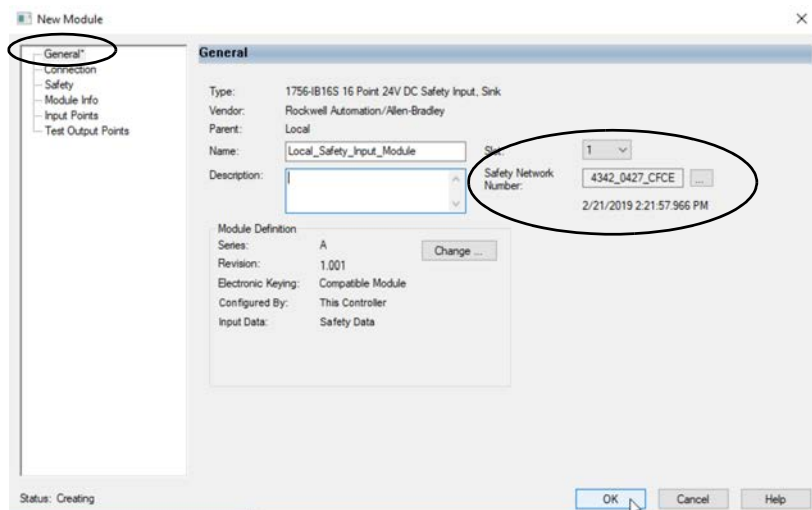

The SNN is a time-based number that uniquely identifies subnets across all networks in the safety system. All 1756 ControlLogix digital safety I/O modules in the same subnet use the same SNN by default.

- Local 1756 ControlLogix digital safety I/O modules are automatically assigned the same SNN as the 1756 Backplane SSN in the controller configuration.
- Remote 1756 ControlLogix digital safety I/O modules are automatically assigned the same SNN.

The Logix Designer application assigns an SNN to the first safety module that is added to a remote system. The application assigns the same SNN to additional safety modules that are added to this remote I/O system.

For more information on Safety Network Numbers, see the GuardLogix 5580 and Compact GuardLogix 5380 Controller Systems Safety Reference Manual, publication [1756-RM012](#).

Module Definition

Module Definition parameters are available on the General tab of the Module Properties dialog box in the Logix Designer application project. [Table 25](#) describes the parameters on the Module Definition dialog box.

1756-IB16S

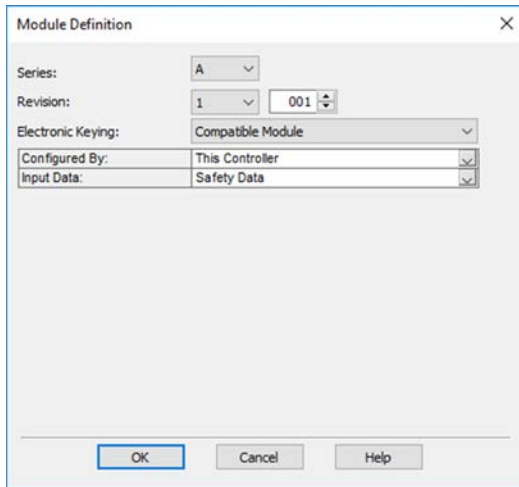

1756-OBV8S

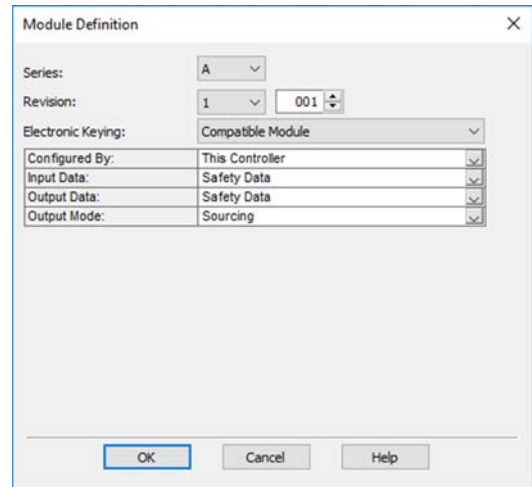

[Table 25](#) describes the parameters on the Module Definition dialog box.

Table 25 - Module Definition Parameters

Parameter	Definition	Available Choices
Series	Module hardware series	Module-specific
Revision	Module firmware revision, including major and minor revision levels	Module-specific
Electronic Keying	Software method by which you reduce the possibility of using the wrong device in a control system. For more information, see the following: <ul style="list-style-type: none"> • Electronic Keying on page 43 • Electronic Keying in Logix5000 Control Systems Application Technique, publication LOGIX-AT001 	<ul style="list-style-type: none"> • Exact Match • Compatible Module
Configured By	Determines the following for the module type you configure: <ul style="list-style-type: none"> • Which controller tags are generated when configuration is complete • Whether you can choose an Output Data type - Output module only • Whether you can choose an Output Mode - Output module only 	<ul style="list-style-type: none"> • This Controller • External Means⁽¹⁾
Input Data	Determines what type of input data is exchanged between the module and the controller. Creates all controller tags specific to the module type being used. IMPORTANT: The 1756-OBV8S output module exchanges input data with the controller.	<ul style="list-style-type: none"> • Safety data • Safety packed data
Output Data - 1756-OBV8S module only	Determines what type of output data is exchanged between the module and the controller. The available choices are dictated by the Configured By parameter choice.	<ul style="list-style-type: none"> • None - If Configured By is External Means. • Safety data and Safety packed data - If Configured By is This Controller.
Output Mode - 1756-OBV8S	Determines how the outputs are used. That is, one of the following: <ul style="list-style-type: none"> • Sourcing outputs. In this case, you connect the external device to only the sourcing point on an output channel. • As connection pairs. In this case, you connect the external device to both the sourcing and sinking points of the bipolar output pair. 	<ul style="list-style-type: none"> • Sourcing • Bipolar

(1) Controller and module establish communication without the controller sending any configuration or output data to the module. A full input data connection is established but depends on the connection between the owner-controller and the module.

Connection Category

The Connection category lets you inhibit the module.

Before you inhibit the module, make sure that you are aware of the impact it has on your application. For more information on inhibiting the module, see [page 41](#).

IMPORTANT You cannot set the Requested Packet Interval (RPI) for the safety modules on the Connections category. For safety modules, you set the RPI on the Safety category.

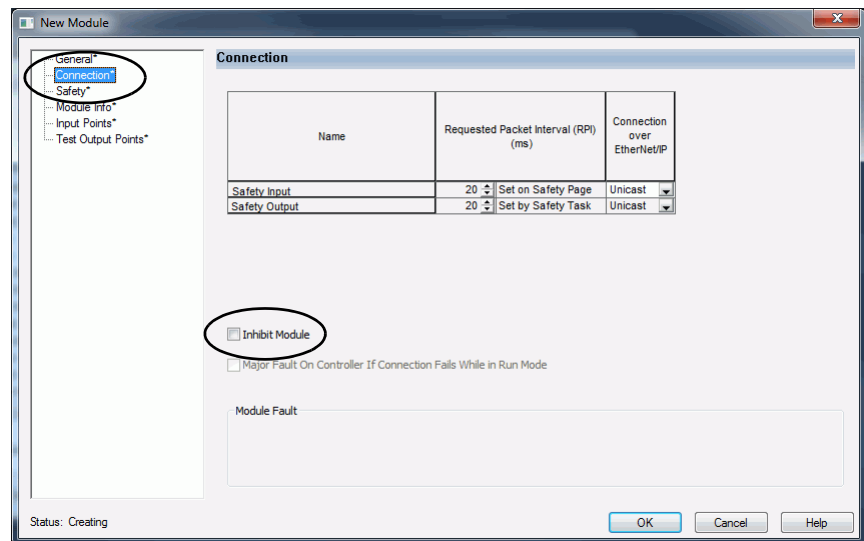

Remote safety modules support the Connection over EtherNet/IP parameter.

- With safety input data, you can choose Unicast or Multicast.
- With safety output data, you **must** use Unicast.

For more information, see [page 31](#).

Safety Category

The Safety category lets you set the RPI rate. You must click the Advanced button to change the Connection Reaction Time Limit configuration.

IMPORTANT Remember, the Safety Task period determines the 1756-OBV8S module RPI.

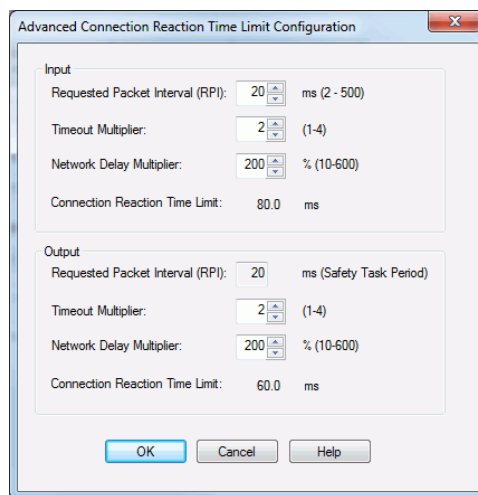
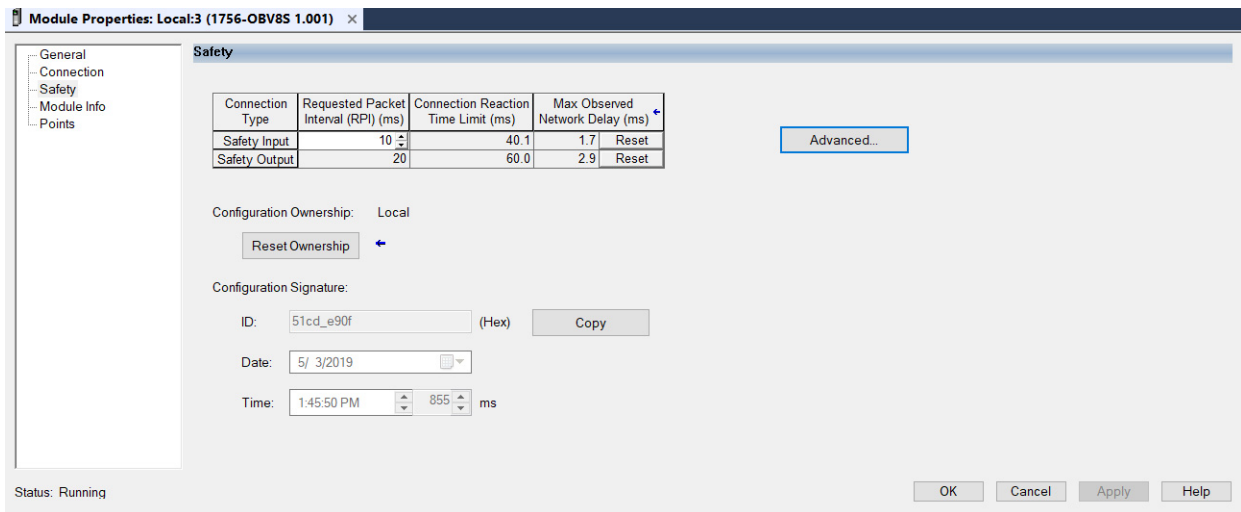

For more information on the RPI and the Connection Reaction Time Limit parameters, see [Requested Packet Interval on page 30](#).

Module Info Category

The Module Info category displays module and status information about the module when the project is online. You can use this category to complete the following:

- Determine the identity of the module.
- Access module diagnostics.
- Refresh the data on the screen.
- Reset the module.

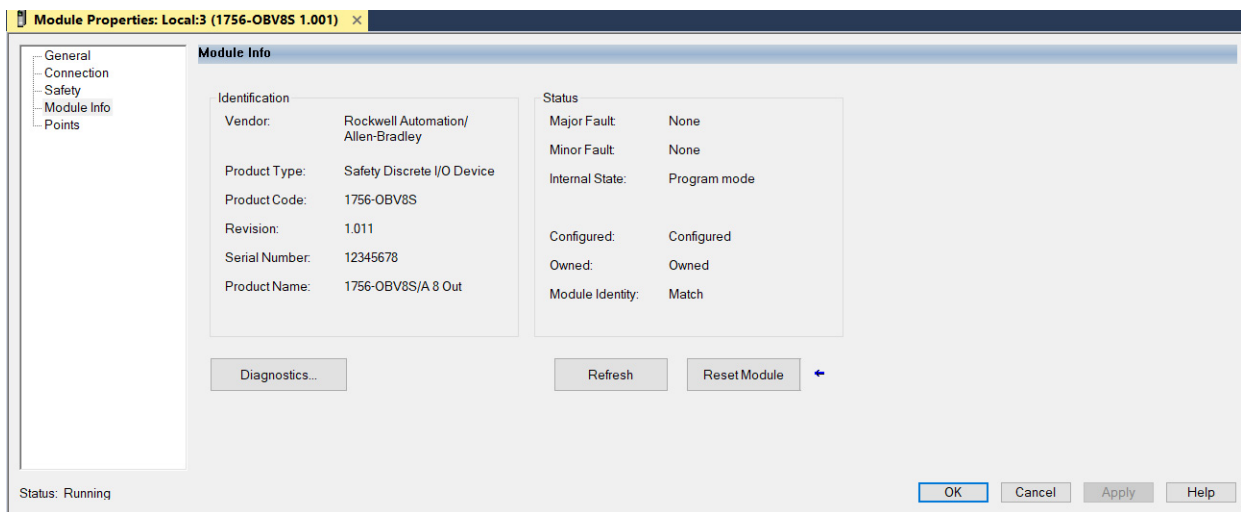

Edit the 1756-IB16S Module Configuration Categories

These categories are available when you configure a 1756-IB16S module:

- [Input Points Category](#)
- [Test Output Points Category](#)

Input Points Category

The Input Points category is only available if you choose This Controller for the Configured By parameter on the Module Definition dialog box. You must configure each point to use it in a Safety application. The inputs are disabled by default.

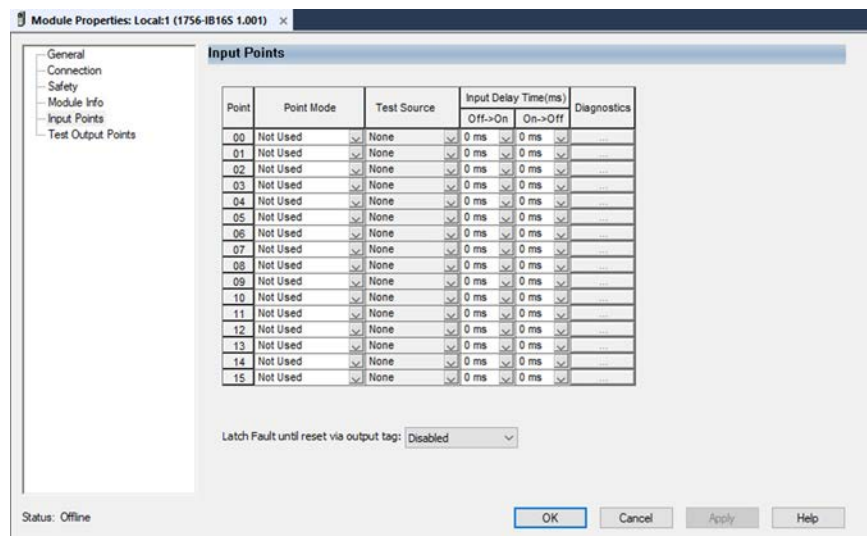

Point Mode

Determines the operation mode of the output point.

- Not Used - The output point is disabled.
- Safety - The output point is enabled.
- Safety Pulse Test - The output point is enabled and a pulse test is periodically performed on the output to make sure the output is functioning. The pulse test only occurs when the point is On. The pulse has a fixed state of periodic.

The default value is Not Used.

Test Source

Displays the Test Source values. There is a value for each point, 00-15. When Safety Pulse Test is selected in Point Mode, the value appears according to the point number.

Input Delay Time (ms)

For more information on input delay times, see [page 50](#).

Test Output Points Category

The Test Output Points category is only available if you choose This Controller for the Configured By parameter on the Module Definition dialog box.

You must configure each point to use it in a Safety application. The outputs are disabled by default.

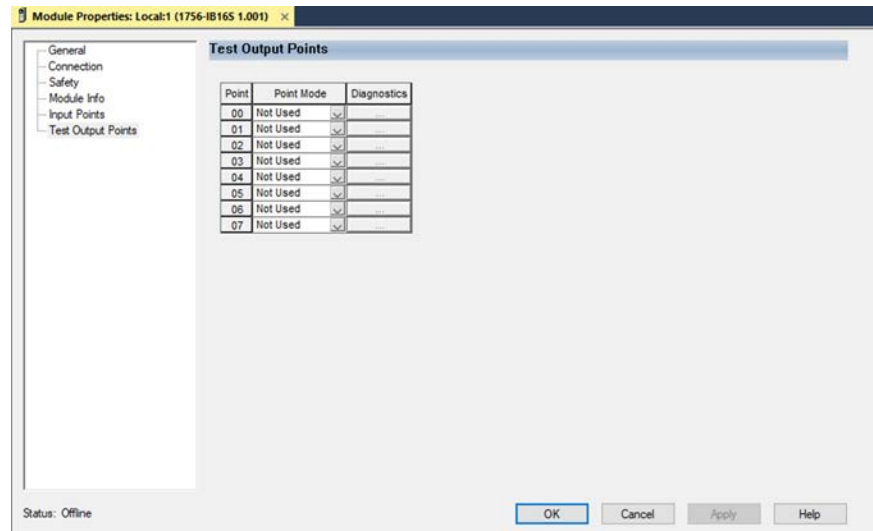

Point Mode

Determines the mode of the test output for the point.

- Not Used - Test output is not used.
- Pulse Test - Use the test output point as a pulse test source.
- Power Supply - Use the test output as a power supply.

Edit the 1756-OBV8S Module Points Category

To use the Points category, on the Module Definition dialog box choose Configured By > This Controller.

The outputs are disabled by default. To use an output in a Safety application, you must configure the Point Operation Type and Point Mode. Optionally, you can configure the Output State During Program Mode and During Communications Fault Mode (Off, Hold)

Point	Point Operation Type	Point Mode	Output State During		Diagnostics
			Program Mode and Communications Fault Mode		
00	Single	Safety	Off		...
01	Single	Safety	Off		...
02	Single	Safety	Off		...
03	Single	Safety	Off		...
04	Single	Safety	Hold		...
05	Single	Safety	Hold		...
06	Single	Safety Pulse Test	Off		...
07	Single	Safety Pulse Test	Hold		...

IMPORTANT If you configure the output state to be Hold, then the output channel cannot be used in a safety application.



WARNING: The selection of "Hold" for Output State During Program Mode and Communications Fault Mode prevents the output point from going to the safe state, making the output point not suitable for a SIL or PL rated safety function. Set Output State During Program Mode and Communications Fault Mode to "Off" to allow points to go to safe state.

TÜV Rheinland has approved GuardLogix 5580 and Compact GuardLogix 5380 controller systems for use in safety-related applications where the de-energized state is always considered to be the safe state. You must ensure each configuration of the safety IO module is set for "Off" under the Output State During Program Mode and Communications Fault Mode selection to consider those output points as part of any equipment's safety function.

Point Operation Type

Single

When the output channel is in the On state and without any faults, the safety outputs turned on. The status is normal. If a fault is detected on the output channel, the safety output data and individual safety output status turn off. See [Single-channel Point Operation Type on page 61](#).

Dual

When dual-channel Point Operation Type is used, output channels function as connection pairs. Connection pairs are as follows:

- Channels 0 and 1
- Channels 2 and 3
- Channels 4 and 5
- Channels 6 and 7

When both output channels in a connection pair are in the On state and without any faults, the safety outputs are turned on. See [Dual-channel Point Operation Type on page 62](#).

Point Mode

Determines the operation mode of the output point.

- Not Used - Output is not used.
- Safety - Output is a safety output.
- Safety Pulse Test - Tests the safety output itself using an internally generated test pulse. Pulse testing detects shorts to the 24V power supply and channel-to-channel shorts. The pulse test only occurs when the point is On. The pulse has a fixed state of periodic.

Output State During Program Mode and Communications Fault Mode

You can select the output state (Off or Hold) for each channel to change to during:

- Program Mode and you encounter a Communications Fault.
- Run Mode and you encounter a Communications Fault.

View the Module Tags

When you create a module, the Logix Designer application creates a set of tags that you can view in the Tag Editor. Each configured feature on your module has a distinct tag that is available for use in the controller program logic.

Complete the following steps to access the tags for a module.

1. In the Controller Organizer, right-click Controller Tags and choose Monitor Tags.

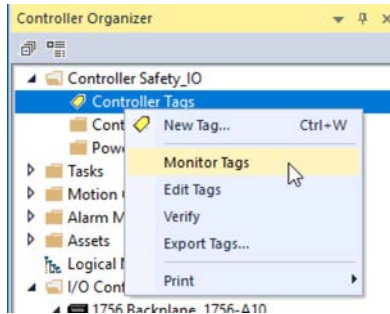

The Controller Tags dialog box appears with data.

2. To view the tags, click the triangle symbols.

The screenshot shows the 'Controller Tags - Safety_IO(controller)' dialog box. The 'Scope' is set to 'Safety_IO' and 'Show' is set to 'All Tags'. The table below lists various tags with their names, values, force masks, styles, data types, and classes.

Name	Value	Force Mask	Style	Data Type	Class
Local:1:I		(...)	(...)	AB:5000_SDI16:I:0	Safety
Local:1:I.RunMode	0		Decimal	BOOL	Safety
Local:1:I.ConnectionFaulted	1		Decimal	BOOL	Safety
Local:1:I.DiagnosticActive	0		Decimal	BOOL	Safety
Local:1:I.DiagnosticSequenceCount	0		Decimal	SINT	Safety
Local:1:I.Pt00		(...)	(...)	CHANNEL_SDI:I:0	Safety
Local:1:I.Pt00.Data	0		Decimal	BOOL	Safety
Local:1:I.Pt00.Fault	1		Decimal	BOOL	Safety
Local:1:I.Pt00.Uncertain	0		Decimal	BOOL	Safety
Local:1:I.Pt00.ShortCircuit	0		Decimal	BOOL	Safety
Local:1:I.Pt00.Status	0		Decimal	BOOL	Safety
Local:1:I.Pt01		(...)	(...)	CHANNEL_SDI:I:0	Safety

For more information on module tags, see Appendix B, [Module Tag Definitions on page 113](#).

Replace a Safety Module

Replacing a safety module that sits on a CIP Safety™ network is more complicated than replacing standard devices because of the Safety Network Number (SNN).

Safety devices require this more complex identifier to make sure that module numbers that are duplicated on separate subnets across all of the networks in the application do not compromise communication between the correct safety devices.

The SNN is a unique identifier that is automatically assigned to each subnet in a safety application. The same SNN is assigned to all of the devices on the subnet.

For example, when an EtherNet/IP adapter is used in a safety application, the Logix Designer application project assigns it an SNN. All safety modules that are installed with that adapter, are automatically assigned the same SNN.

However, each safety module requires a unique identifier within the same subnet. A DeviceID is used to uniquely identify each safety module. The SNN and module slot number make up the DeviceID of the safety module.

Reset to Out-of-Box Configuration

When the Logix Designer application is online, the Safety tab of the Module Properties dialog box displays the current configuration ownership. When the opened project owns the configuration, Local is displayed.

When a second device owns the configuration, Remote is displayed, along with the SNN, and node address or slot number of the configuration owner. Communication error is displayed if the module read fails.

If the connection is Local, you must inhibit the module connection before you reset ownership. To inhibit the module:

1. Right-click the module and choose Properties.
2. On the Connection tab, click Inhibit module.
3. Click Apply and then OK.

Follow these steps to reset the module to its out-of-box configuration when online.

1. Right-click the module and choose Properties.
2. On the Safety tab, click Reset Ownership.

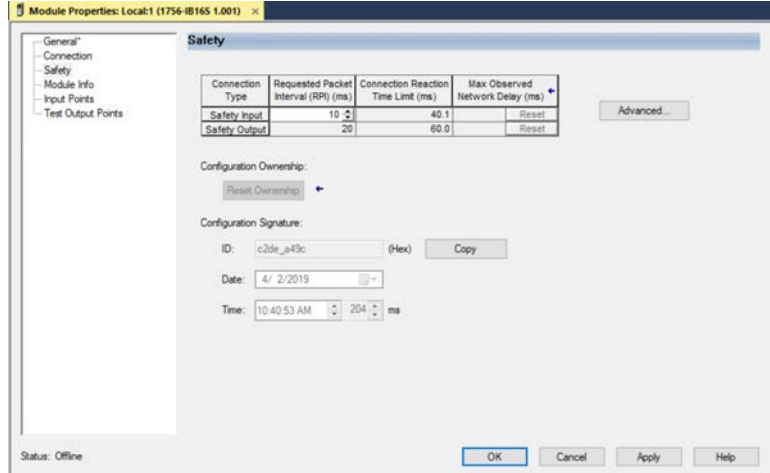

3. When a dialog box appears asking if you want to continue with the reset, read it and click Yes.

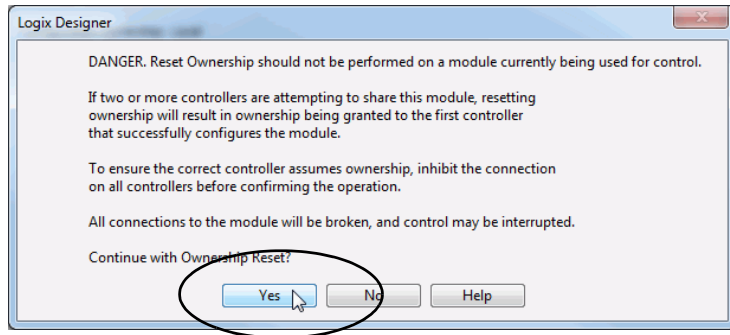

Replace a Module in a Logix 5000 System

Consider the following conditions before you replace a safety module in a Logix 5000™ system:

- If you rely on a portion of the CIP Safety system to maintain SIL 3 behavior during module replacement and functional testing, you must use the Configure Only When No Safety Signature Exists feature.
- If there is only one safety controller on the network, or if you do not rely on the entire routable CIP Safety control system to maintain SIL 3/PL (d or e) during the replacement and functional testing of a module, you can use the Configure Always feature.

Replacement with 'Configure Only When No Safety Signature Exists' Enabled

When a module is replaced, the configuration is downloaded from the safety controller if the DeviceID of the new module matches the original. The DeviceID is updated whenever the SNN is set.

If the project is configured with Configure Only When No Safety Signature Exists enabled, follow the appropriate instructions in to replace a 1756 ControlLogix digital safety I/O module.

After you complete the steps in a scenario correctly, the DeviceID matches the original. This match enables the safety controller to download the proper module configuration, and re-establish the safety connection

Table 26 - Replacing a Module

GuardLogix® Safety Signature Exists	Replacement Module Condition	Action Required
No	No SNN (Out-of-box)	None. The device is ready for use.
Yes or No	Same SNN as original safety task configuration	None. The device is ready for use.
Yes	No SNN (Out-of-box)	See Scenario 1 - Replacement Device is Out-of-box and Safety Signature Exists on page 96.
Yes	Different SNN from original safety task configuration	See Scenario 2 - Replacement Device SNN is Different from Original and Safety Signature Exists on page 98.
No		See Scenario 3 - Replacement Device SNN is Different from Original and No Safety Signature Exists on page 101.

Scenario 1 - Replacement Device is Out-of-box and Safety Signature Exists

1. Remove the old I/O device and install the new device.
2. Right-click the replacement safety I/O device and choose Properties.
3. On the General category, click to the right of the safety network number to open the Safety Network Number dialog box.

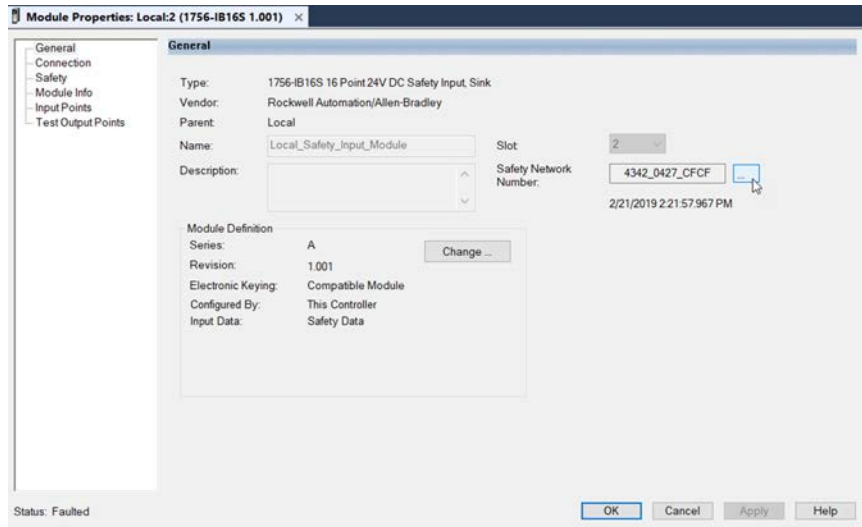

4. Click Set.

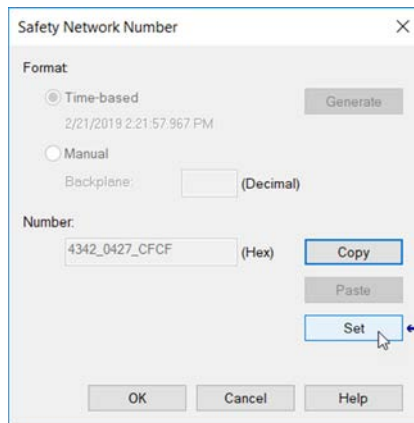

5. Click Yes on the confirmation dialog box to set the SNN and accept the replacement device.

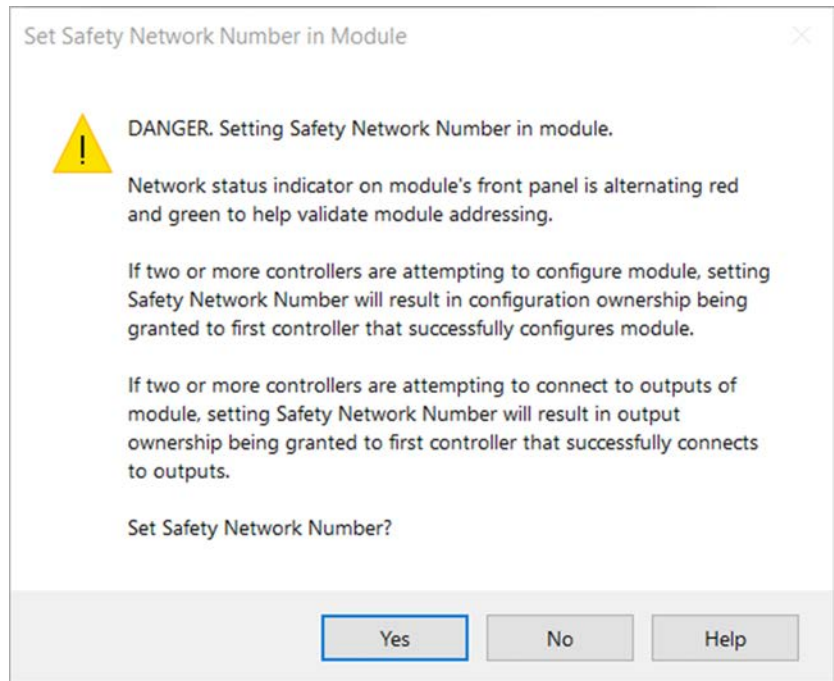

6. Follow your company-prescribed procedures to functionally test the replaced I/O device and system and to authorize the system for use.

Scenario 2 - Replacement Device SNN is Different from Original and Safety Signature Exists

1. Remove the old I/O device and install the new device.
2. Right-click your safety I/O device and choose Properties.
3. Click the Safety tab.
4. Click Reset Ownership.

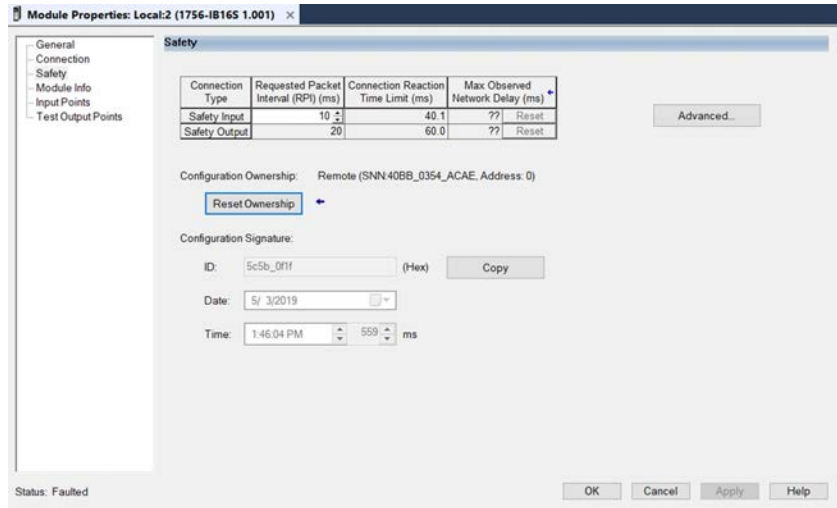

5. On the Logix Designer application Dialog, click Yes.

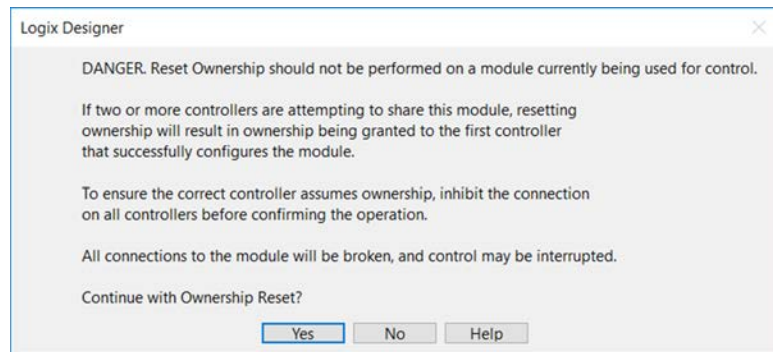

6. On the next Logix Designer application Dialog, click Yes.

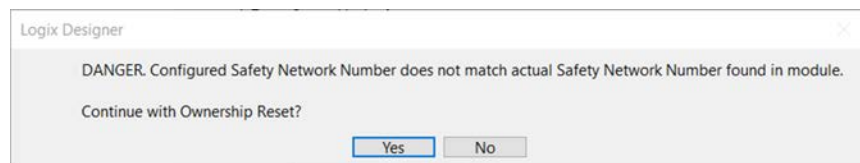

7. The Configuration Ownership now shows Not Owned.

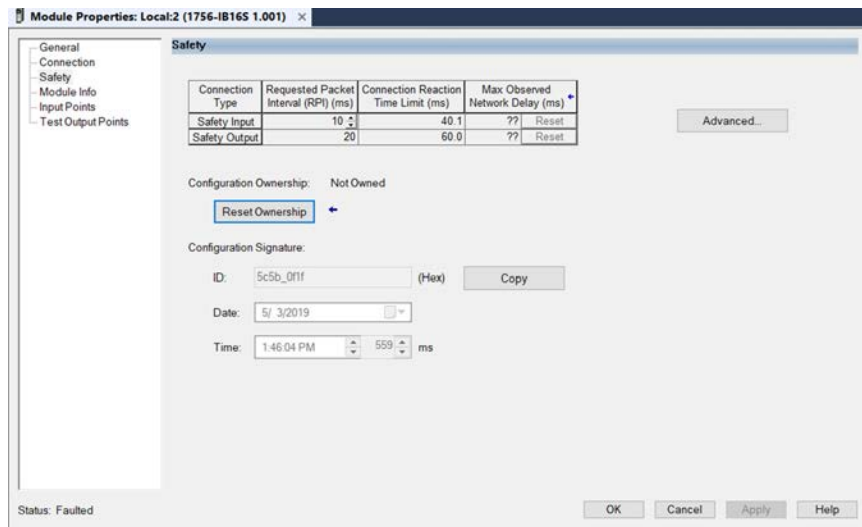

8. Click the module General category.

9. Click  to the right of the safety network number to open the Safety Network Number dialog box.

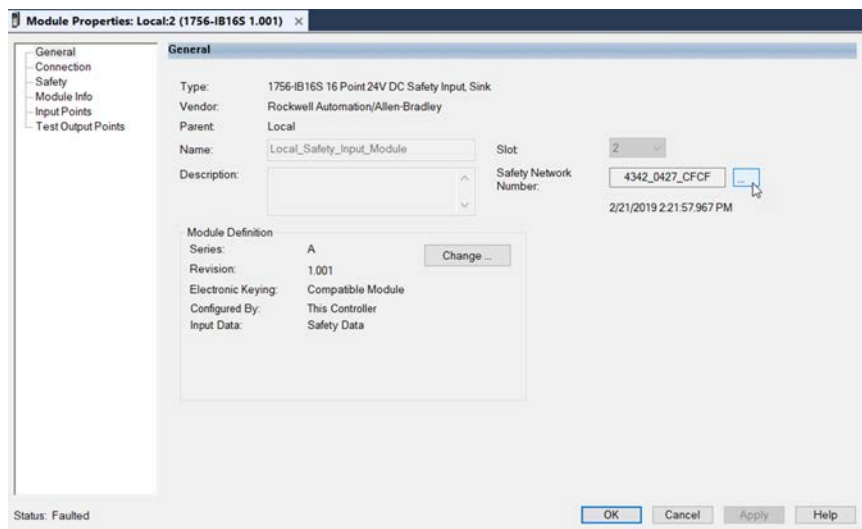

10. Click Set.

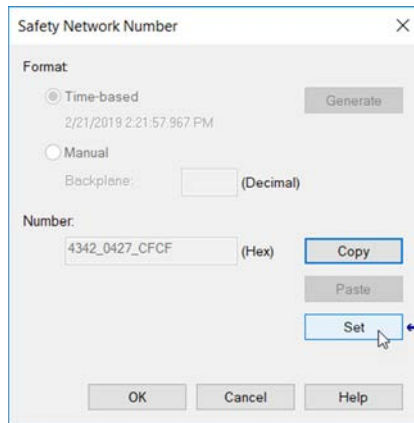

11. Click Yes on the confirmation dialog box to set the SNN and accept the replacement device.

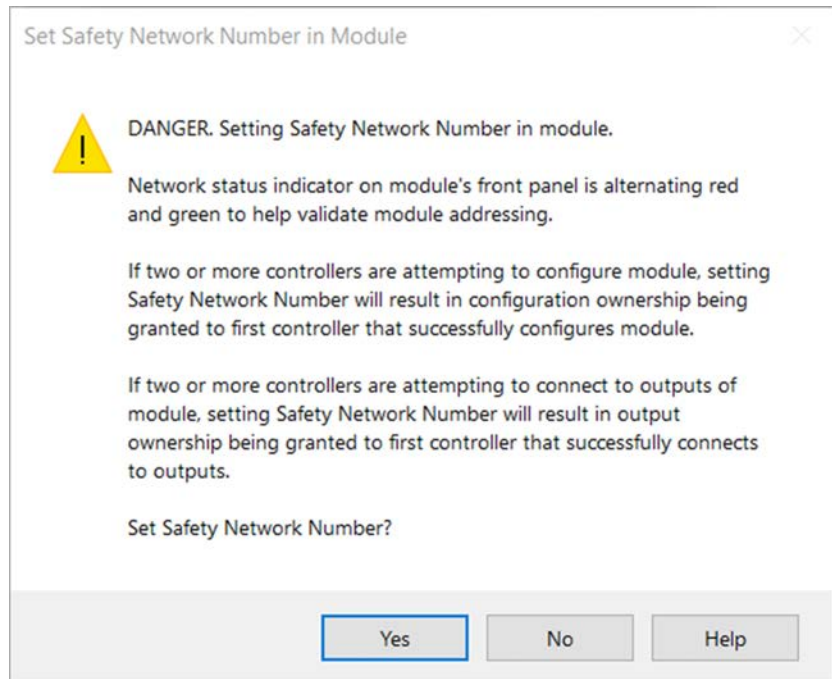

12. Follow your company-prescribed procedures to functionally test the replaced I/O device and system and to authorize the system for use.

Scenario 3 - Replacement Device SNN is Different from Original and No Safety Signature Exists

1. Remove the old I/O device and install the new device.
2. Right-click your safety I/O device and choose Properties.
3. Click the Safety tab.

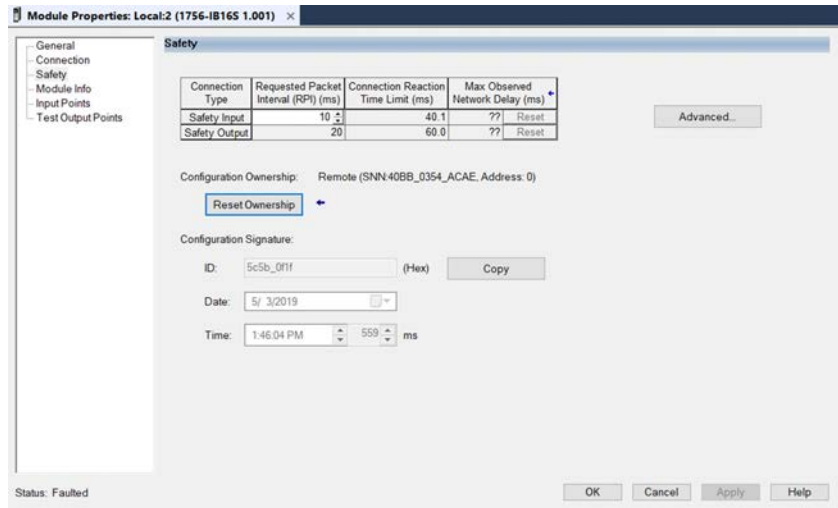

4. Click Reset Ownership.
5. On the Logix Designer application Dialog, click Yes.

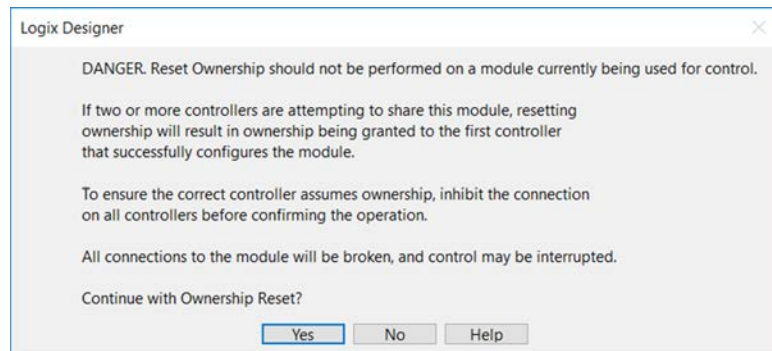

6. On the next Logix Designer application Dialog, click Yes.

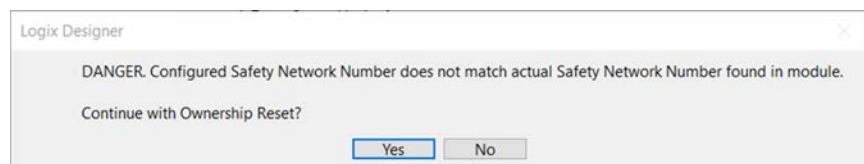

7. Follow your company-prescribed procedures to functionally test the replaced I/O device and system and to authorize the system for use.

Replacement with 'Configured Always' Enabled



ATTENTION: Enable the 'Configure Always' feature only if the entire CIP Safety Control System is not being relied on to maintain SIL 3 behavior during the replacement and functional testing of a module.

Do not place modules that are in the out-of-box condition on a CIP Safety network when the Configure Always feature is enabled, except while following this replacement procedure.

When the 'Configure Always' feature is enabled, the controller automatically checks for and connects to a replacement module that meets all the following requirements:

- The controller has configuration data for a compatible module at that network address.
- The module is in out-of-box condition or has an SNN that matches the configuration.

If the project is configured for 'Configure Always', follow the appropriate steps to replace a safety module.

1. Remove the old I/O module and install the new module.

If	Then
the module is in out-of-box condition	go to step 6 . No action is needed for the controller to take ownership of the module.
an SNN mismatch error occurs (because the module was previously owned)	go to the next step to reset the module to out-of-box condition.

2. Right-click your I/O module and choose Properties.
3. Click the Safety tab.
4. Click Reset Ownership.
5. Click OK.
6. Follow your company-prescribed procedures to functionally test the replaced I/O module and system and to authorize the system for use.

Troubleshoot Your Module

Topic	Page
Module Status Indicators	103
Use the Logix Designer Application for Troubleshooting	105

You can use the module status indicators and the Studio 5000 Logix Designer® application to troubleshoot the I/O modules.

Module Status Indicators

1756 ControlLogix® digital safety I/O modules use these status indicators:



OK Status Indicators

The OK status indicator shows the module status.

Table 1 - Module OK Status Indicator

Indicator State	Description
Off	There is no module power applied.
Green	The device is operating in a normal condition. At least one IO connection is in the established state.
Flashing Green	The device is OK, but it does not have a connection. A connection may be established, but the Validator has not completed an initial Time Coordination exchange.
Red	The device has an unrecoverable fault. Minimum recovery is to cycle power. It may be necessary to replace the device.
Flashing red	<ul style="list-style-type: none"> • The device has a recoverable fault. The fault can be read from the device through the bus or network. • An IO connection time-out. • Recoverable NVS Fault. • A firmware update is being performed on the module.
Flashing Red/Green	<ul style="list-style-type: none"> • Indicates that you must commission the UNID on the device.

[Table 2](#) describes the I/O Status (ST) and Fault Status (FLT) status indicators.

Table 2 - Module ST/FLT Status Indicator

Indicator State	Description
Off	The digital I/O point is Off. Channel is not configured or enabled.
Yellow	The digital I/O point is On.
Flashing red	<ul style="list-style-type: none"> • Open wire / open load • Input/output Off • Short circuit
Red	Internal Malfunction
Flashing Red/Yellow	<ul style="list-style-type: none"> • Open load • Output ON / Open wire • Input ON

Use the Logix Designer Application for Troubleshooting

The Logix Designer application indicates the presence of fault conditions.

Fault conditions are reported in the following ways:

- [Warning Signal in the I/O Configuration Tree](#)
- [Status and Fault Information in Module Properties Categories](#)
- [Logix Designer Application Tag Editor](#)

Warning Signal in the I/O Configuration Tree

As shown in [Figure 1](#), a warning icon appears in the I/O Configuration tree when a fault occurs.

Figure 1 - Warning Icon in Controller Organizer

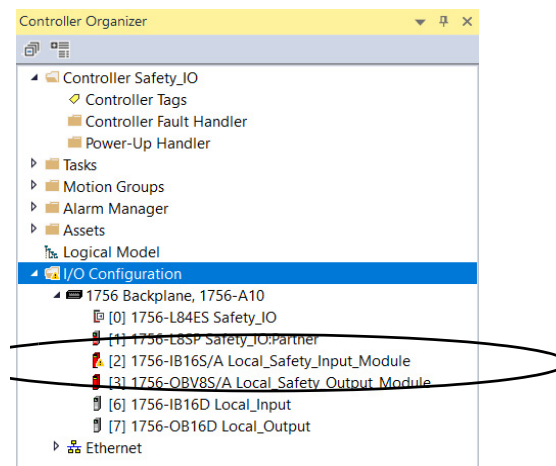

Status and Fault Information in Module Properties Categories

The Module Properties section in the Logix Designer application includes a series of categories. The numbers and types of categories varies by module type.

Each category includes options to configure the module or monitor the status of the module. The following are ways to monitor the state of a module for faults:

- [Module Status on General Category](#)
- [Module Fault Descriptions on Connection Category](#)
- [Module Fault Descriptions on Module Info Category](#)

Module Status on General Category

As shown in [Figure 2](#), the status of a module is indicated on the General category of the Modules Properties.

Figure 2 - Fault Message in Status Line

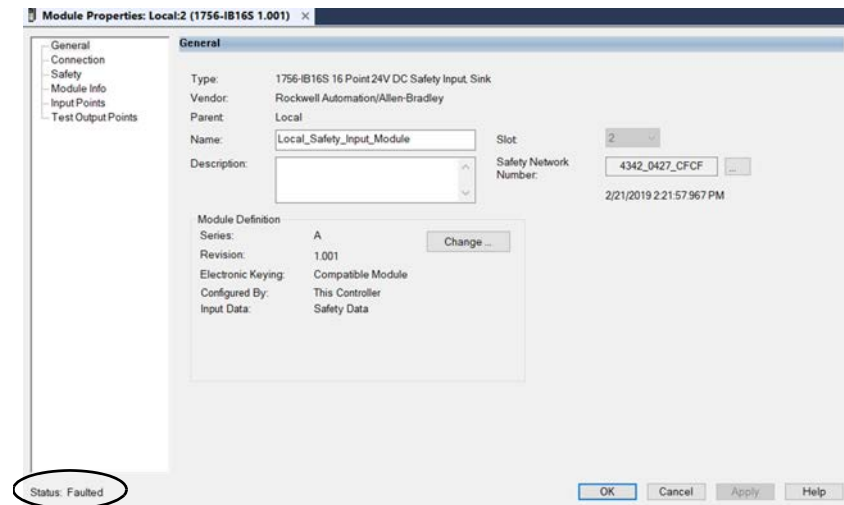

Module Fault Descriptions on Connection Category

As shown in [Figure 3](#), a module fault description that includes an error code that is associated with the specific fault type is listed on the Connection category.

Figure 3 - Fault Description with Error Code

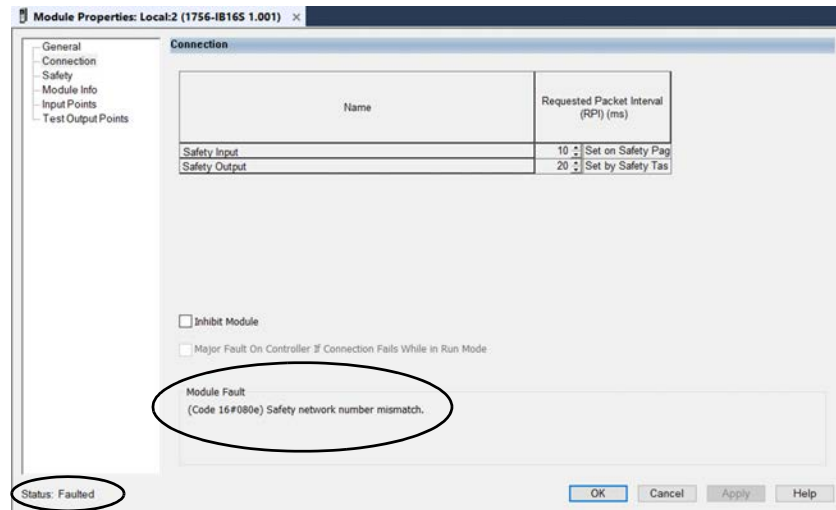

Module Fault Descriptions on Module Info Category

As shown in [Figure 4](#), major and minor fault information is listed on the Module Info tab in the Status section.

Figure 4 - Major and Minor Fault Information

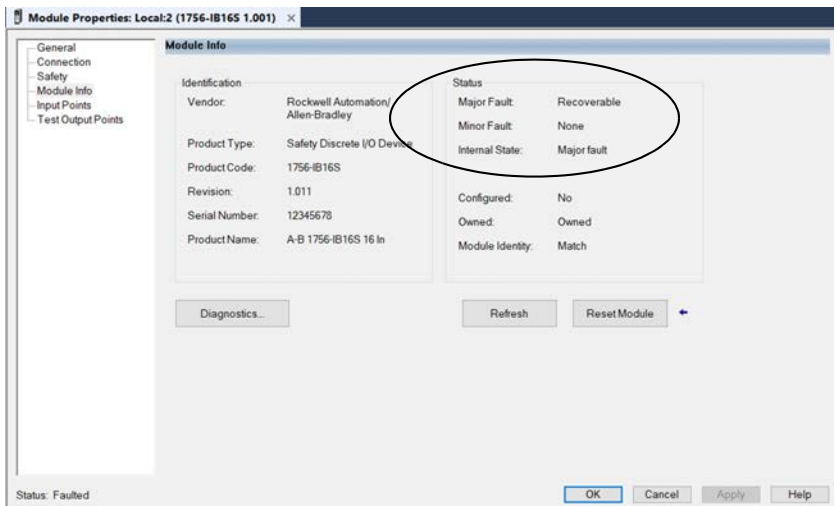

Module and Point Diagnostics

You can use diagnostics in a Logix Designer application project to monitor module and/or point operating conditions and to troubleshoot issues that affect a module and/or point. Diagnostics when the **project is online**.

- [Module Diagnostics](#)
- [Point Diagnostics](#)

Module Diagnostics

Module diagnostics provide information on a module-wide basis. For example, the Module Diagnostics dialog box indicates the mode within which a module is operating, that is, Run, Remote Run, Remote Program, or Program.

Module Diagnostics are accessible from the Module Info category on the Module Properties dialog box, as shown in [Figure 5](#).

Figure 5 - Module Information Diagnostics

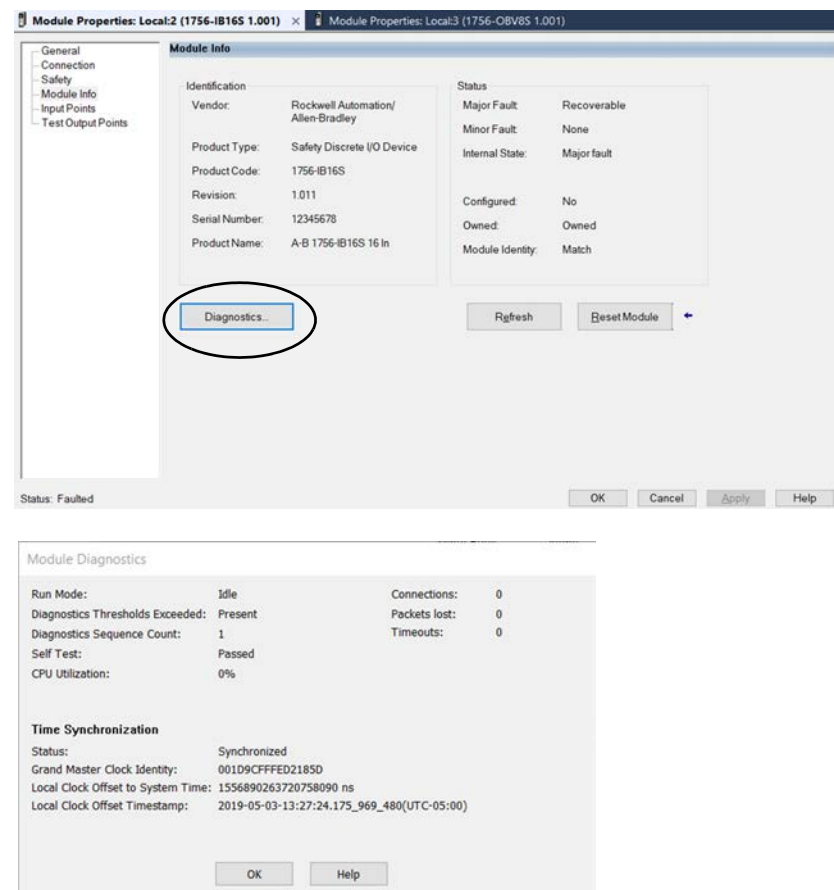

Point Diagnostics

Point diagnostics provide information on an individual point basis. For example, you can check individual points on a 1756-IB16S safety input module for the presence of a Short Circuit condition.

Remember the following:

- Not all 1756 ControlLogix digital safety I/O modules provide point diagnostics.
- The point diagnostics that are available vary by module type and functionality.
- There are some differences between modules, but most commonly, the Module Properties dialog box category from which you can access point diagnostics is Points.

Figure 6 shows how to access output point diagnostics on the 1756-IB16S module and the diagnostics dialog box.

Figure 6 - Point Diagnostics

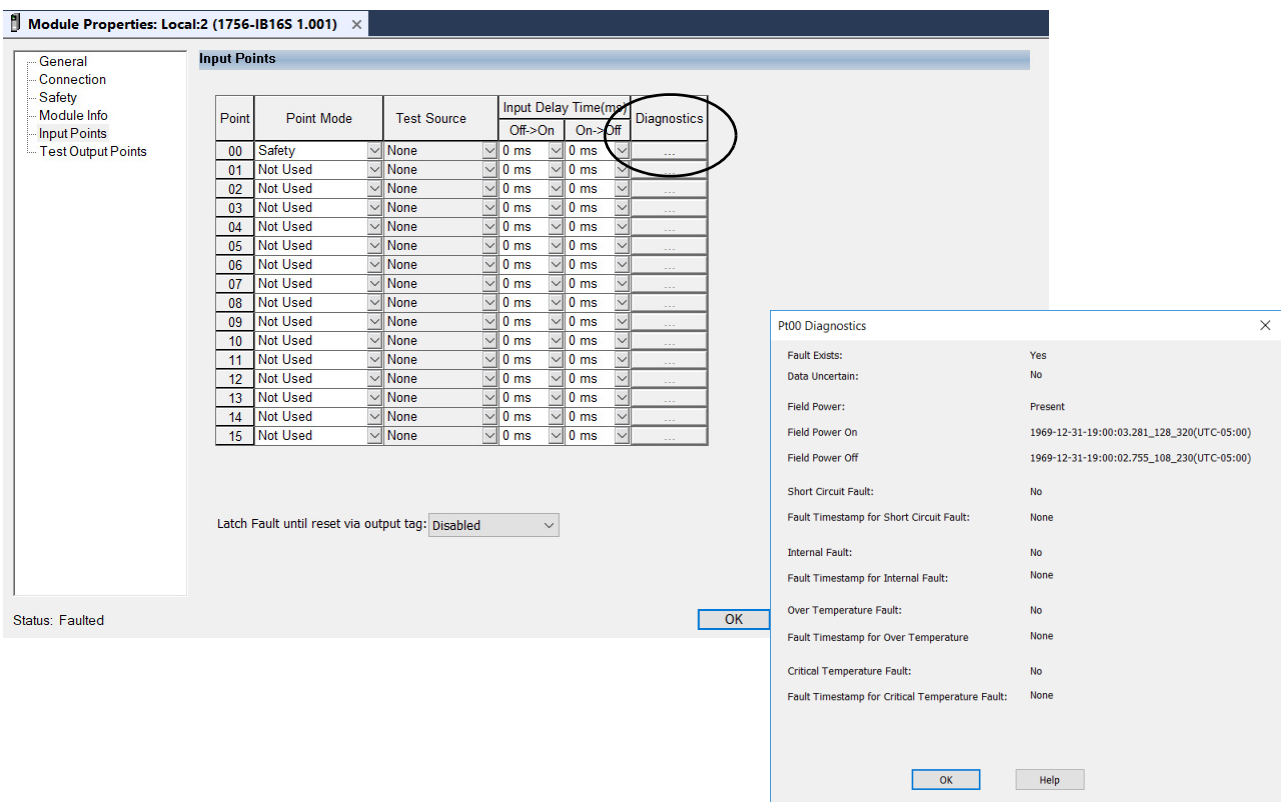

Logix Designer Application Tag Editor

Figure 7 show how fault conditions are indicated in the controller tags.

Figure 7 - Fault Indication in Controller Tags

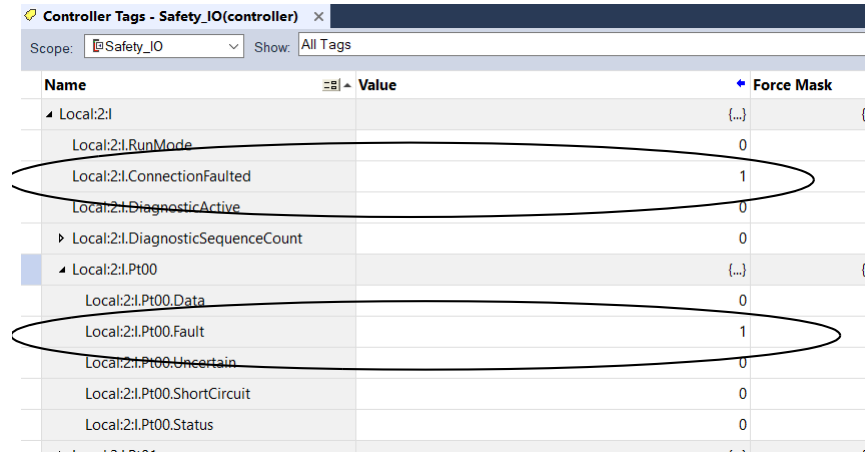

Name	Value	Force Mask
Local:2:I		{...}
Local:2:I.RunMode		0
Local:2:I.ConnectionFaulted		1
Local:2:I.DiagnosticActive		0
Local:2:I.DiagnosticSequenceCount		0
Local:2:I.Pt00		{...}
Local:2:I.Pt00.Data		0
Local:2:I.Pt00.Fault		1
Local:2:I.Pt00.Uncertain		0
Local:2:I.Pt00.ShortCircuit		0
Local:2:I.Pt00.Status		0

InternalFault Triggered on the Safety Output Module

[Table 3](#) describes conditions that can trigger InternalFault.

Table 3 - Conditions That Trigger InternalFault

Conditions	Output Behavior	Tag Value	Diagnostic Value	I/O Status Indicator State
<ul style="list-style-type: none"> Output Mode - Bipolar Point Operation Type - Single Point Mode - Safety A load is connected between a sourcing output point and a sinking output point. O.Ptxx.Data tag = 0 An overload resistor shorts the sourcing output point to 0V DC 	Faults	I.Ptxx.Fault tag = 1	InternalFault = 1	The I/O status indicator for the faulted output point is steady red.
<ul style="list-style-type: none"> Output Mode - Bipolar Point Operation Type - Single Point Mode - Safety or Safety Pulse Test A load is connected between a sourcing output point and a sinking output point. O.Ptxx.Data tag = 0 Either output point shorts to 0V DC 	Faults	I.Ptxx.Fault tag = 1	InternalFault = 1	
<ul style="list-style-type: none"> Output Mode - Sourcing Point Operation Type - Single Point Mode - Safety or Safety Pulse Test O.Ptxx.Data tag = 1 Output point shorts to 24V DC 	Faults	I.Ptxx.Fault tag = 1 IMPORTANT: The tag value occurs on the faulted output point and all of its associated group points.	InternalFault = 1 IMPORTANT: The diagnostic value occurs on the faulted output point and all of its associated group points.	

When the conditions that trigger the diagnostics as described in [Table 3](#) are corrected, the output faults are cleared, the tags and diagnostics reset to 0, and the I/O status indicators turn off.

Notes:

Module Tag Definitions

Topic	Page
Access the Tags	114
Access the Tags	114
1756-IB16S Module Tags	115
1756-OBV8S Module Tags	117

Module tags are created when you add a module to the Studio 5000 Logix Designer® application project.

The set of tags that are associated with any module depends on the choices that you make in the Module Definition dialog box.

For the 1756-IB16S and 1756-OBV8S modules, there are Input and Output tags.

IMPORTANT The tables that are in this section list all tags available with a module. Not all tags in the list are used when that module type is added to a project. Tag use varies by module configuration.

Access the Tags

You can view tags from the Tag Editor.

1. Open your Logix Designer application project.
2. Right-click Controller Tags and choose Monitor Tags.

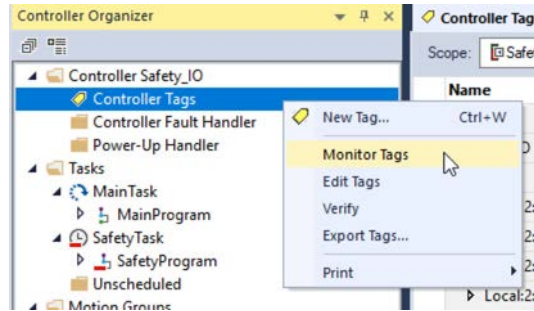

3. Open the tags as necessary to view specific tags.

Name	Value	Force Mask	Style	Data Type	Class
Local:1:I		(...)	(...)	AB:5000_SD116:I:0	Safety
Local:1:O		(...)	(...)	AB:5000_SD116:O:0	Safety
Local:2:I		(...)	(...)	AB:5000_SDO8:I:0	Safety
Local:2:I.RunMode	0		Decimal	BOOL	Safety
Local:2:I.ConnectionFaulted	1		Decimal	BOOL	Safety
Local:2:I.DiagnosticActive	0		Decimal	BOOL	Safety
Local:2:I.DiagnosticSequenceCount	0		Decimal	SINT	Safety
Local:2:I.Pt00		(...)	(...)	AB:5000_SafetyReadback_Channel:I:0	Safety
Local:2:I.Pt00.Readback	0		Decimal	BOOL	Safety
Local:2:I.Pt00.Fault	1		Decimal	BOOL	Safety
Local:2:I.Pt00.Uncertain	0		Decimal	BOOL	Safety
Local:2:I.Pt00.ShortCircuit	0		Decimal	BOOL	Safety
Local:2:I.Pt00.FieldPowerOff	0		Decimal	BOOL	Safety
Local:2:I.Pt00.Status	0		Decimal	BOOL	Safety

Name Conventions

The module tags use defined naming conventions. The conventions are as follows: (example tag name = remote_ethernet_adapter_1:I.Pt00.Data).

An example module tag name is constructed as follows:

- remote_ethernet_adapter = name of the EtherNet/IP™ adapter in the system
- 1 = slot number
- I = tag type

For the 1756-IB16S and 1756-OBV8S modules, the possible I/O tag types are I (input) and O (output).

- Pt00 = module point number
- Data = function

In this case, Data represents the input data that is returned to the owner-controller.

1756-IB16S Module Tags

This section describes the tags that are associated with the 1756-IB16S module.

Input Tags

[Table 4](#) describes the 1756-IB16S module input tags.

Table 4 - 1756-IB16S Module Input Tags

Name	Data Type	Definition	Valid Values	Available With These Input Data Type Choices
RunMode	BOOL	Module operating state	<ul style="list-style-type: none"> 0 = Idle 1 = Run 	Safety Data Safety Packed Data
ConnectionFaulted	BOOL	Indicates if a connection is running. The module sets this tag to 0 when connected. If the module is not connected, it changes the tag to 1.	<ul style="list-style-type: none"> 0 = Connection running 1 = Connection not running 	Safety Data Safety Packed Data
DiagnosticActive	BOOL	Indicates if any diagnostics are active or if the prognostics threshold is reached.	<ul style="list-style-type: none"> 0 = No diagnostics active 1 = One or more diagnostics are active or the prognostics threshold is reached 	Safety Data Safety Packed Data
Uncertain	BOOL	Indicates that the channel data can be inaccurate but the degree of inaccuracy is not known . For more information, see Module Data Quality Reporting on page 40 .	<ul style="list-style-type: none"> 0 = Good data 1 = Uncertain data <p>This tag is set to 1 when the module has reached a critical operating temperature or is higher the acceptable operating temperature.</p> <p>IMPORTANT: Once the condition that causes the tag to change to 1 is removed, the tag automatically resets to 0.</p>	Safety Packed Data
DiagnosticSequenceCount	SINT	Increments for each time a distinct diagnostic condition is detected, and when a distinct diagnostic condition transitions from detected to not detected. Set to zero by product reset or power cycle. Wraps from 255 (-1) to 1 skipping zero.	<ul style="list-style-type: none"> 1...255 <p>The value of 0 is skipped except during module power-up.</p>	Safety Data Safety Packed Data
Ptxx.Data	BOOL	Indicates the current safety input value.	<ul style="list-style-type: none"> 0 = Off 1 = On 	Safety Data Safety Packed Data
Ptxx.Fault	BOOL	Indicates one of the following: <ul style="list-style-type: none"> The channel data is inaccurate and cannot be trusted for use in the application. For more information, see Module Data Quality Reporting on page 40. The channel is set to Not Used. 	<ul style="list-style-type: none"> 0 = Good data 1 = Bad data (faulted) or set to Not Used <p>If the tag is set to 1, you must troubleshoot the module to correct the cause of the inaccuracy.</p> <p>IMPORTANT: Once the condition that causes the tag to change to 1 is removed, you must complete the steps described in Safety Input Fault Reset on page 50 to reset this tag to 0.</p> <p>If the tag is 1 because the channel is set to Not Used, no action is required.</p>	Safety Data
Ptxx.Uncertain	BOOL	Indicates that the channel data can be inaccurate but the degree of inaccuracy is not known . For more information, see Module Data Quality Reporting on page 40 .	<ul style="list-style-type: none"> 0 = Good data 1 = Uncertain data <p>This tag is set to 1 when the module has reached a critical operating temperature or is higher the acceptable operating temperature.</p> <p>IMPORTANT: Once the condition that causes the tag to change to 1 is removed, the tag automatically resets to 0.</p>	Safety Data

Table 4 - 1756-IB16S Module Input Tags

Name	Data Type	Definition	Valid Values	Available With These Input Data Type Choices
Ptxx.ShortCircuit	BOOL	Indicates a short circuit.	<ul style="list-style-type: none"> 0 = No short circuit 1 = Short circuit 	Safety Data
Ptxx.Status	BOOL	Indicates the status of the channel.	<ul style="list-style-type: none"> 0 = Bad, causing a fault 1 = Good 	Safety Data Safety Packed Data
Ptxx.TestOutputStatus	BOOL		•	Safety Packed Data
Testxx.Readback	BOOL	Indicates that a 24V DC power source is present at the test output.	<ul style="list-style-type: none"> 0 = 24V DC power is not present 1 = 24V DC power is present 	Safety Data
Testxx.Fault	BOOL	Indicates one of the following: <ul style="list-style-type: none"> The channel data is inaccurate and cannot be trusted for use in the application. For more information, see Module Data Quality Reporting on page 40. The channel is set to Not Used. 	<ul style="list-style-type: none"> 0 = Good data 1 = Bad data (faulted) or set to Not Used If the tag is set to 1, you must troubleshoot the module to correct the cause of the inaccuracy. IMPORTANT: Once the condition that causes the tag to change to 1 is removed, you must complete the steps described in Safety Input Fault Reset on page 50 to reset this tag to 0. ⁽¹⁾ If the tag is 1 because the channel is set to Not Used, no action is required.	Safety Data
Testxx.Uncertain	BOOL	Indicates that the channel data can be inaccurate but the degree of inaccuracy is not known . For more information, see Module Data Quality Reporting on page 40 .	<ul style="list-style-type: none"> 0 = Good data 1 = Uncertain data This tag is set to 1 when the module has reached a critical operating temperature or is higher the acceptable operating temperature. IMPORTANT: Once the condition that causes the tag to change to 1 is removed, the tag automatically resets to 0.	Safety Data
Testxx.ShortCircuit	BOOL	Indicates an output short circuit	<ul style="list-style-type: none"> 0 = No short circuit 1 = Short circuit 	Safety Data
Testxx.FieldPowerOff	BOOL	Indicates that a field power loss condition exists on the channel.	<ul style="list-style-type: none"> 0 = No field power off condition 1 = Field power off condition 	Safety Data
Testxx.Status	BOOL	Indicates the channel status.	<ul style="list-style-type: none"> 0 = Fault 1 = Good 	Safety Data

(1) If the Point Mode for the test output is Pulse Test or Power Supply when the Short Circuit condition is detected, the condition can be corrected but you cannot set the test output to a safe state.

Output Tags

[Table 5](#) describes the 1756-IB16S module output tags.

Table 5 - 1756-IB16S Module Output Tags

Name	Size	Definition	Valid Values	Available With These Output Data Type Choice
Ptxx.ResetFault	BOOL	When 'Latch Fault until reset via output tag' mode is Enabled, the I/O channel will hold safety input fault indications until it checks that the fault is removed. If the fault is removed, it will clear only the fault status upon detecting that the ResetFault bit in its channel sees a rising edge.	Rising edge: the fault status is released if the fault has been removed.	Safety Data

1756-OBV8S Module Tags

This section describes the tags that are associated with the 1756-OBV8S module.

Input Tags

[Table 6](#) describes the 1756-OBV8S module input tags.

Table 6 - 1756-OBV8S Module Input Tags

Name	Data Type	Definition	Valid Values	Available With These Input Data Type Choices
RunMode	BOOL	Module's operating state	<ul style="list-style-type: none"> 0 = Idle 1 = Run 	Safety Data Safety Packed Data
ConnectionFaulted	BOOL	Indicates if a connection is running. The module sets this tag to 0 when connected. If the module is not connected, the controller overwrites the tag to 1.	<ul style="list-style-type: none"> 0 = Connection is working 1 = Connection is not working 	Safety Data Safety Packed Data
DiagnosticActive	BOOL	Indicates if any diagnostics are active or if the prognostics threshold is reached.	<ul style="list-style-type: none"> 0 = No diagnostics active 1 = One or more diagnostics are active or the prognostics threshold is reached 	Safety Data Safety Packed Data
Uncertain	BOOL	Indicates that the channel data can be inaccurate but the degree of inaccuracy is not known . For more information, see Module Data Quality Reporting on page 40 .	<ul style="list-style-type: none"> 0 = Good data 1 = Uncertain data <p>This tag is set to 1 when the module has reached a critical operating temperature or is higher the acceptable operating temperature.</p> <p>IMPORTANT: Once the condition that causes the tag to change to 1 is removed, the tag automatically resets to 0.</p>	Safety Packed Data
DiagnosticSequenceCount	SINT	Increments for each time a distinct diagnostic condition is detected, and when a distinct diagnostic condition transitions from detected to not detected. Set to zero by product reset or power cycle. Wraps from 255 (-1) to 1 skipping zero.	<ul style="list-style-type: none"> 1...255 	Safety Data Safety Packed Data
Ptxx.Readback	BOOL	Indicates that a 24V DC power source is connected to the output circuit	<ul style="list-style-type: none"> 0 = 24V DC power is not present 1 = 24V DC power is present 	Safety Data Safety Packed Data
Ptxx.Fault	BOOL	Indicates one of the following: <ul style="list-style-type: none"> The channel data is inaccurate and cannot be trusted for use in the application. For more information, see Module Data Quality Reporting on page 40. The channel is set to Not Used. 	<ul style="list-style-type: none"> 0 = Good data 1 = Bad data (faulted) or set to Not Used <p>If the tag is set to 1, you must troubleshoot the module to correct the cause of the inaccuracy.</p> <p>IMPORTANT: Once the condition that causes the tag to change to 1 is removed, you must complete the steps described in Safety Output Fault Reset on page 63 to reset this tag to 0.⁽¹⁾</p> <p>If the tag is 1 because the channel is set to Not Used, no action is required.</p>	Safety Data
Ptxx.Uncertain	BOOL	Indicates that the channel data can be inaccurate but the degree of inaccuracy is not known . For more information, see Module Data Quality Reporting on page 40 .	<ul style="list-style-type: none"> 0 = Good data 1 = Uncertain data <p>This tag is set to 1 when the module has reached a critical operating temperature or is higher the acceptable operating temperature.</p> <p>IMPORTANT: Once the condition that causes the tag to change to 1 is removed, the tag automatically resets to 0.</p>	Safety Data
Ptxx.ShortCircuit	BOOL	Indicates a short circuit	<ul style="list-style-type: none"> 0 = No short circuit 1 = Short circuit 	Safety Data

Table 6 - 1756-OBV8S Module Input Tags

Name	Data Type	Definition	Valid Values	Available With These Input Data Type Choices
Ptxx.FieldPowerOff	BOOL	Indicates that a field power loss condition exists on the channel.	<ul style="list-style-type: none"> 0 = No field power off condition 1 = Field power off condition 	Safety Data
Ptxx.Status	BOOL	Indicates the channel status.	<ul style="list-style-type: none"> 0 = Bad, causing fault 1 = Good 	Safety Data Safety Packed Data

(1) If the Point Mode for the test output is Pulse Test or Power Supply when the Short Circuit condition is detected, the condition can be corrected but you cannot set the test output to a safe state.

Output Tags

[Table 7](#) describes the 1756-OBV8S module output tags.

Table 7 - 1756-OBV8S Module Output Tags

Name	Size	Definition	Valid Values	Available With These Output Data Type Choices
Ptxx.Data	BOOL	Indicates the current output value.	<ul style="list-style-type: none"> 0 = Off 1 = On 	Safety Data Safety Packed Data
Ptxx.ResetFault	BOOL	When 'Latch Fault until reset via output tag' mode is Enabled, the I/O channel will hold safety input fault indications until it checks that the fault is removed. If the fault is removed, it will clear only the fault status upon detecting that the ResetFault bit in its channel sees a rising edge.	Rising edge: the fault status is released if the fault has been removed.	Safety Data

Application and Wiring Examples for Safety Modules

Topic	Page
1756-IB16S Module Wiring Diagrams	120
1756-OBV8S Module Wiring Diagrams	123

This appendix provides example wiring diagrams for the 1756 ControlLogix® safety I/O modules that can be used in functional safety applications.

The wiring configuration affects the safety application level to which a 1756 ControlLogix I/O safety module is suitable.

IMPORTANT This section shows example wiring diagrams on the 1756-IB16S safety input module and the 1756-OBV8S safety output module.

Before You Begin

Before you wire your module, remember that a SELV/PELV-rated 24V power supply is required to supply field-side power to 1756 ControlLogix I/O safety modules.

1756-IB16S Module Wiring Diagrams

You must connect a 24V DC SELV/PELV power source to the DC+/- terminals to provide field-side power.

- IMPORTANT**
- The 24V (DC+ and DC-) power connections are used to supply field-side power to the module.
 - All terminals with the same name are connected together on the module. For example, DC+ can be connected to either terminal marked DC +.
 - Do not physically connect more than two wires to a single RTB terminal.

When the module is wired as shown, it is suitable for applications that are rated up to, and including, **Category 2** and **PLd** as defined in ISO 13849-1.

To achieve that suitability rating, you may have to perform diagnostic testing of the safety function. One diagnostic test method is to configure the safety input channel for Safety Pulse Test to test the circuit for short circuits to 24V DC.

Channel Connections

The diagram shows devices that are connected to safety input channel 0 and test output channel 0. You can connect devices to all 16 channels.

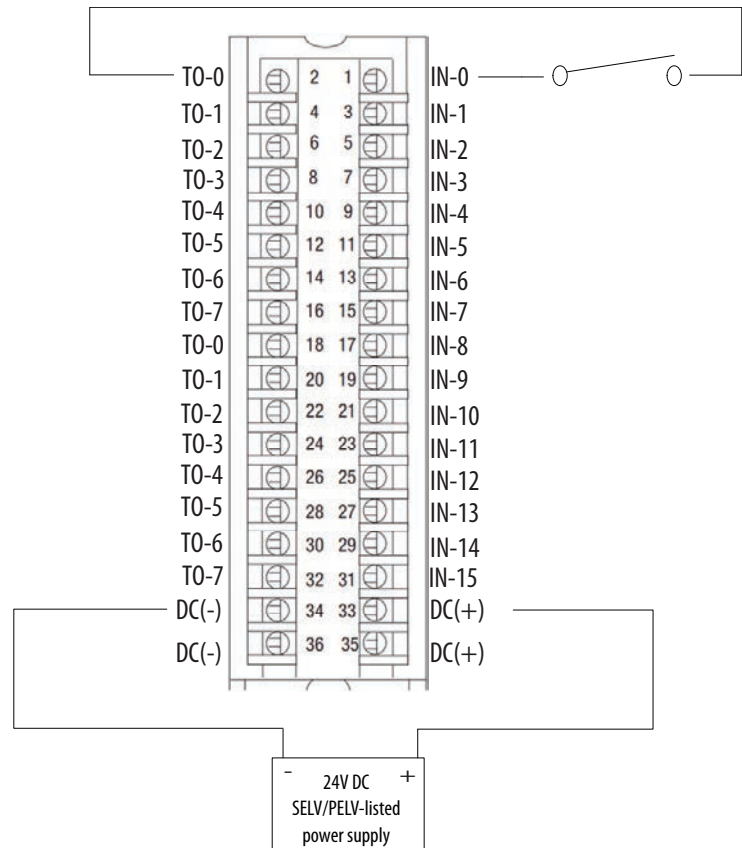

When the module is wired as shown, it is suitable for applications that are rated up to, and including, **Category 3** and **PLd** as defined in ISO 13849-1.

IMPORTANT Switches are suitable for applications that are rated up to, and including SIL 3 CL3, PLe, Cat 3.

Channel Connections

This diagram shows devices that are connected to safety input channels 0 and 1. You can connect devices to all 16 channels.

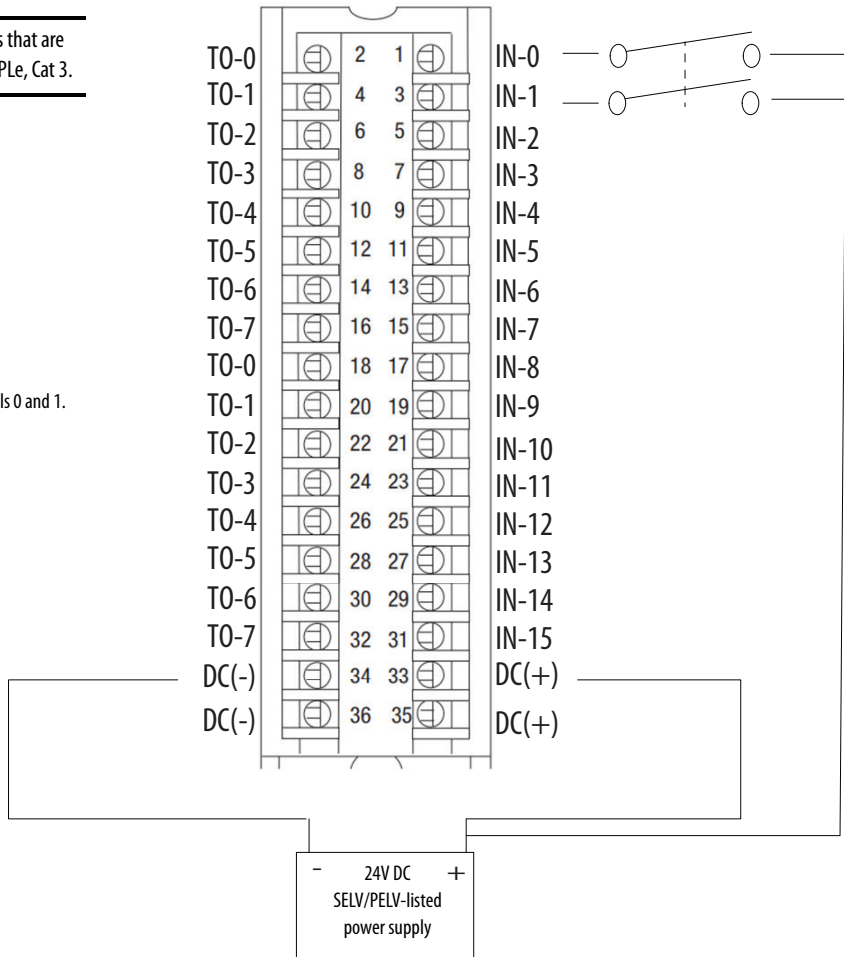

When the module is wired as shown, it is suitable for applications that are rated up to, and including, **Category 4** and **PLe** as defined in ISO 13849-1. To achieve that suitability rating, you may have to perform diagnostic testing of the safety function.

One diagnostic test method is to configure the safety input channel for Safety Pulse Test to test the circuit for short circuits to 24V DC. Safety input pairs must be associated with different Test Output sources.

Channel Connections

This diagram shows devices that are connected to safety input channels 0 and 1; and to test outputs 0 and 1. You can connect devices to all 16 channels.

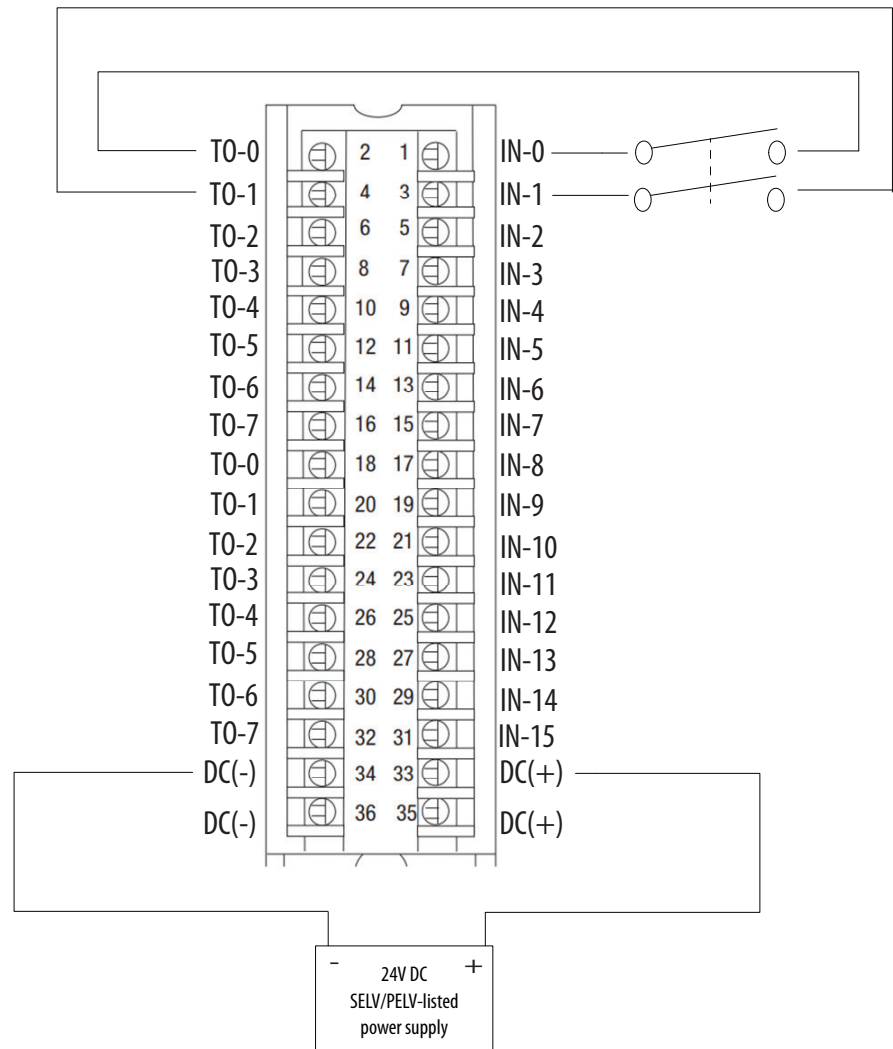

1756-OBV8S Module Wiring Diagrams

You can use the 1756-OBV8S module in Bipolar mode or Sourcing mode.

-
- IMPORTANT**
- The 24V (DC+ and DC-) power connections are used to supply field-side power to the module.
 - All terminals with the same name are connected together on the module. For example, DC+ can be connected to either terminal marked DC +.
 - Do not physically connect more than two wires to one RTB terminal.
-

Bipolar Mode

When the module is wired as shown, it is suitable for applications that are rated up to, and including, **Category 2** and **PLd** as defined in ISO 13849-1.

To achieve that suitability rating, you may have to perform diagnostic testing and monitoring of the safety function. One diagnostic test method is to configure the safety output channel for Safety Pulse Test to test the circuit for short circuits to 24V DC.

Channel Connections

This wiring example shows connections to Safety Output 0. You are not limited to using channel 0 in this mode. You can use all channels as determined by your application.

We **strongly recommend** that, if you have a direct connection between the safety output module and an input module and those modules are powered by separate power supplies, you connect module DC- and actuator DC- together. This practice helps to eliminate grounding float from disrupting diagnostics.

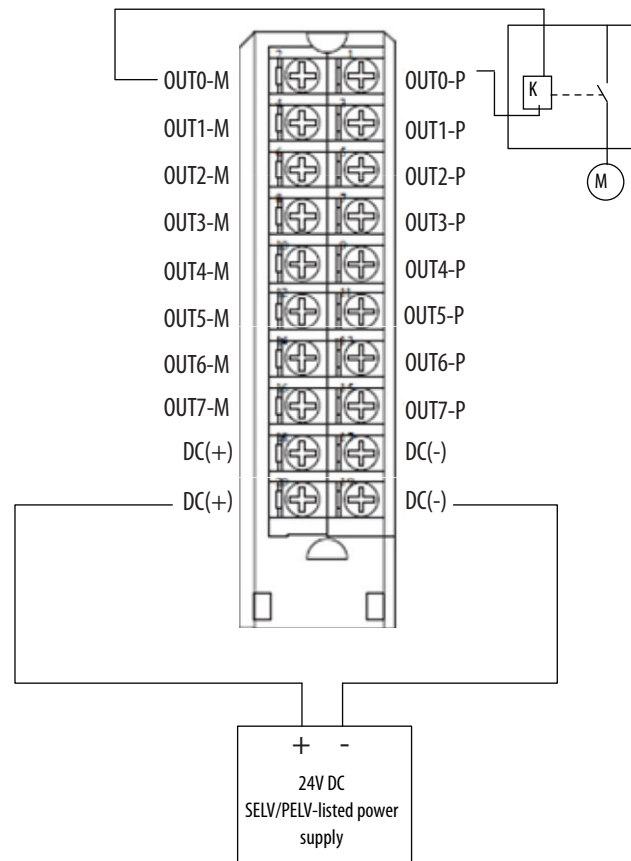

When the module is wired as shown, it is suitable for applications that are rated up to, and including, **Category 4** and **PLe** as defined in ISO 13849-1.

To achieve that suitability rating, you may have to perform diagnostic testing and monitoring of the safety function. One diagnostic test method is to configure the safety output channel for Safety Pulse Test to test the circuit for short circuits to 24V DC.

- The application is configured so that a No Load fault can only be detected if the wires from **both** the P- terminal and the M-terminal are disconnected.

For Cat.4 applications, if your application remains in safe state, that is, the output is off, for a prolonged duration, we recommend that you take one of these actions:

- Apply output monitoring at the actuator. The monitoring can be direct or indirect.
- Limit the safe state to no more than 24 hours.
- Conduct functional test if safe state dwell time increases.

Connection Pairs

The terminals for each channel function as a Bipolar connection pair when you use a 1756-0BV8S module in Bipolar switching mode. For example, the Safety Output 0 P (Sourcing) terminal and Safety Output 0 M (Sinking) terminal are a Bipolar connection pair. That is, they are a P-M pair.

When the module is in Bipolar switching mode, you must connect the device to both terminals.

Channel Connections

This wiring example shows connections to the P-M pair for Safety Output 0. You are not limited to using channel 0 in this mode. You can use all channel pairs as determined by your application.

We **strongly recommend** that, if you have a direct connection between the safety output module and an input module and those modules are powered by separate power supplies, you connect the DC- terminals together. This practice helps to eliminate grounding float from disrupting diagnostics.

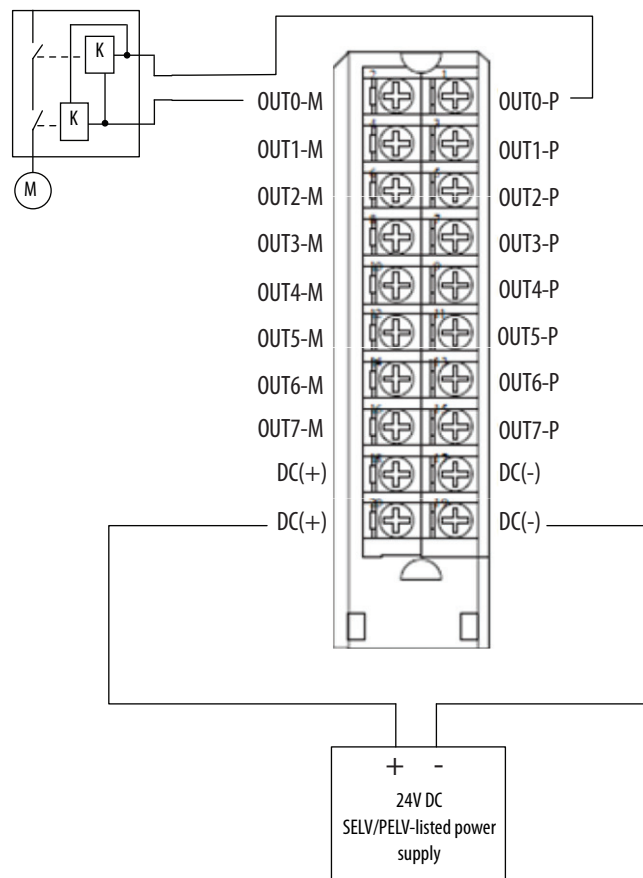

When the module is wired as shown, it is suitable for applications that are rated up to, and including, **Category 4** and **PLe** as defined in ISO 13849-1.

To achieve that suitability rating, you may have to perform diagnostic testing and monitoring of the safety function. One diagnostic test method is to configure the safety output channel for Safety Pulse Test to test the circuit for short circuits to 24V DC.

- We **strongly recommend** that you connect separate shielded cables to the P terminal and the M terminal to reduce possibility of a short between these terminals. If a short is detected across the P-M pair, the module outputs are turned off, but the actuator that is connected to the output pair remains on.
- No Load and Overload conditions are only detectable at the P terminal.

For Cat.4 applications, if your application remains in safe state, that is, the output is off, for a prolonged duration, we recommend that you take one of these actions:

- Apply output monitoring at the actuator. The monitoring can be direct or indirect.
- Limit the safe state to no more than 24 hours.
- Conduct functional test if safe state dwell time increases.

Actuator DC Power

In this wiring configuration, you must connect the **DC+ terminal to an SELV/PELV-listed power supply**.

The DC+ and DC- on the actuator must be connected to the same power supply as the DC+ and DC- on the module.

Connection Pairs

The terminals for each channel function as a Bipolar connection pair when you use a 1756-OBV8S module in Bipolar switching mode. For example, the Safety Output 0 P (Sourcing) terminal and Safety Output 0 M (Sinking) terminal are a Bipolar connection pair. That is, they are a P-M pair.

When the module is in Bipolar switching mode, you must connect the device to both terminals.

Channel Connections

This wiring example shows connections to the P-M pair for Safety Output 0. You are not limited to using channel 0 in this mode. You can use all channel pairs as determined by your application.

We **strongly recommend** that, if you have a direct connection between the safety output module and an input module and those modules are powered by separate power supplies, you connect the DC- terminals together. This practice helps to eliminate grounding float from disrupting diagnostics.

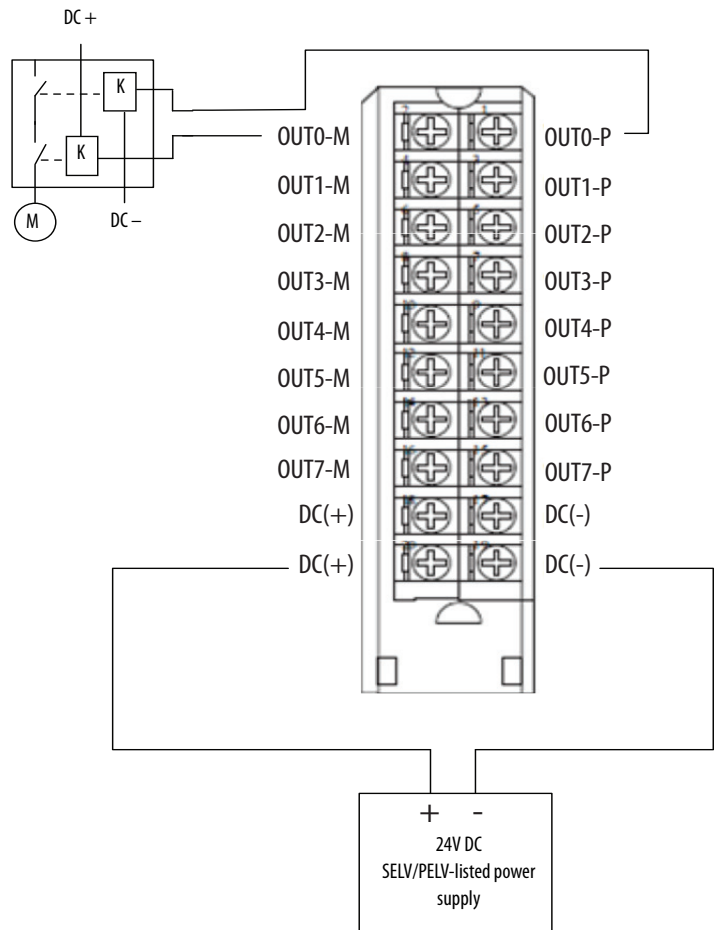

Sourcing Mode

When the module is wired as shown, it is suitable for applications that are rated up to, and including, **Category 2** and **PLd** as defined in ISO 13849-1.

To achieve that suitability rating, you may have to perform diagnostic testing and monitoring of the safety function. One diagnostic test method is to configure the safety output channel for Safety Pulse Test to test the circuit for short circuits to 24V DC.

Channel Connections

This wiring example shows connections to Safety Output 0. You are not limited to using channel 0 in this mode. You can use all channels as determined by your application.

We **strongly recommend** that, if you have a direct connection between the safety output module and an input module and those modules are powered by separate power supplies, you connect module DC- and actuator DC- together. This practice helps to eliminate grounding float from disrupting diagnostics.

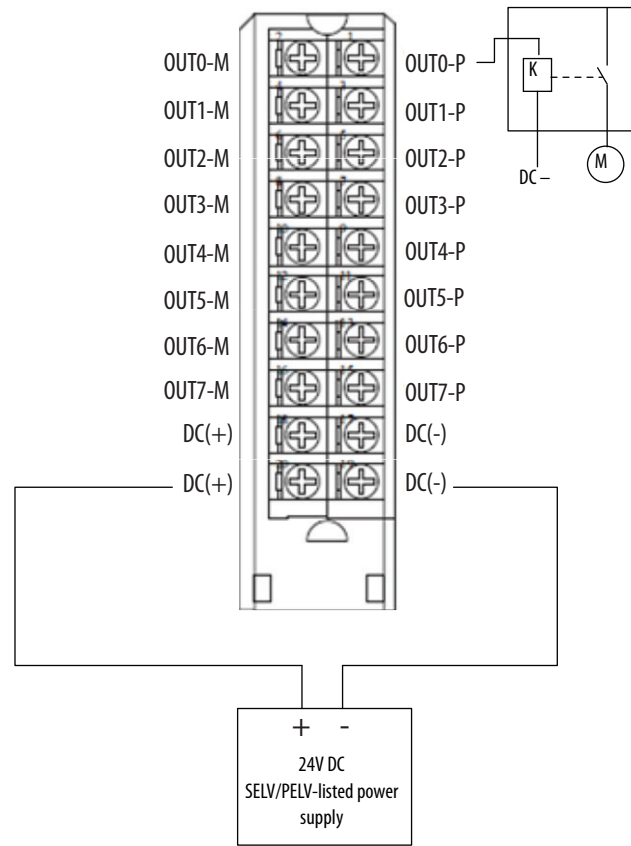

When the module is wired as shown, it is suitable for applications that are rated up to, and including, **Category 4** and **PLe** as defined in ISO 13849-1.

To achieve that suitability rating, you may have to perform diagnostic testing and monitoring of the safety function. One diagnostic test method is to configure the safety output channel for Safety Pulse Test to test the circuit for short circuits to 24V DC.

For Cat.4 applications, if your application remains in safe state, that is, the output is off, for a prolonged duration, we recommend that you take one of these actions:

- Apply output monitoring at the actuator. The monitoring can be direct or indirect.
- Limit the safe state to no more than 24 hours.
- Conduct functional test if safe state dwell time increases.

Connection Pairs

When you use dual-channel sourcing wiring on the 1756-OBV8S module, you must connect the devices to dual-channel connection pairs. For example, the devices are connected to channels 4 and 5 because they are a connection pair. These channels are dual-channel connection pairs:

- Channels 0 and 1 (shown)
- Channels 2 and 3
- Channels 4 and 5
- Channels 6 and 7

Channel Connections

This wiring example shows connections to Safety Output 0 P and Safety Output 1P. You are not limited to using channels 0 and 1 in this mode. You can use all channel pairs as determined by your application.

We **strongly recommend** that, if you have a direct connection between the safety output module and an input module and those modules are powered by separate power supplies, you connect module DC- and actuator DC- together. This practice helps to eliminate grounding float from disrupting diagnostics.

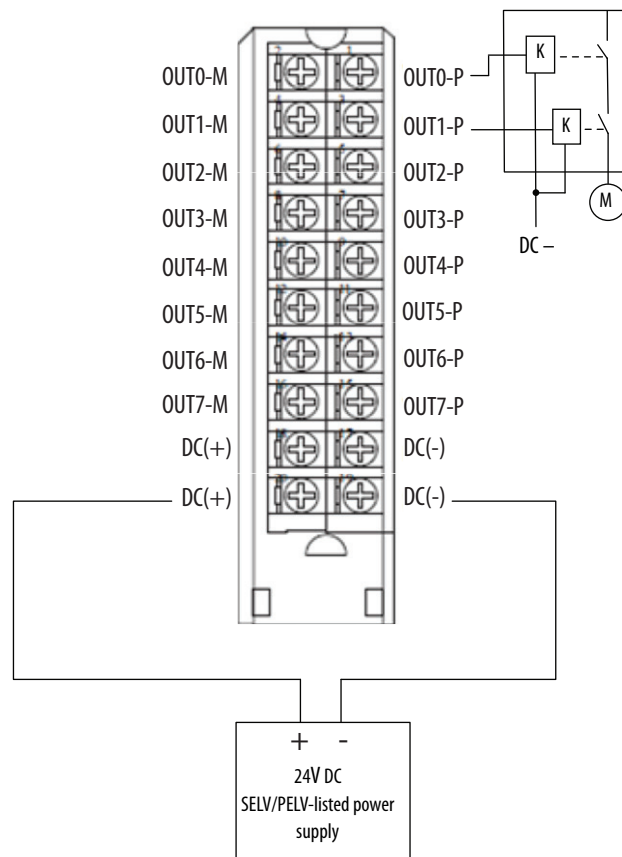

Notes:

Safety Data for Safety Modules

This appendix lists calculated values for probability of a dangerous failure on demand (PFD), average frequency of a dangerous failure per hour (PFH), and mean time to failure (MTTF). PFD and PFH calculations comply with IEC61508, edition 2, 2010.

- For the 1756-IB16S, calculated values of PFD and PFH appear in [Table 8 on page 130](#)
- For the 1756-OBV8S, calculated values of PFD and PFH appear in [Table 9 on page 131](#).

PFD and PFH must be calculated for the devices within the system to comply with the SIL level that is required for application.

You are responsible for following the requirements of ISO 13849-1:2008, to assess Performance Levels in your safety system.

You must functionally test every I/O module by individually toggling each input point and also verify that the controller detects it within the safety reaction time (SRT). Additionally, you must individually toggle each output point by the controller and user-verified that the output point changes state.

For more information, see the GuardLogix® 5580 and CompactGuardLogix 5380 Controller Systems Safety Reference Manual, publication [1756-RM012](#).

1756-IB16S Safety Data

Table 8 lists the safety data for the 1756-IB16S module.

Table 8 - 1756-IB16S Module Safety Parameter Data

Attribute	Point Operation Type		
	Single Channel	Dual Channel (at controller instruction level)	
Safety Function Architecture (HFT)	0	1	
Safe Failure Rate (λ_s) [failures/hr]	7.9621E-07	8.6252E-07	
Safe Detected Failure Rate (λ_{SD}) ⁽¹⁾	7.95153E-07	8.61767E-07	
Safe Undetected Failure Rate (λ_{SU}) ⁽¹⁾	1.05746E-09	7.52962E-10	
Dangerous Failure Rate (λ_D) [failures/hr]	4.49496E-07	5.34022E-07	
Dangerous Detected Failure Rate (λ_{DD}) [failures/hr]	4.48899E-07	5.33556E-07	
Dangerous Undetected Failure Rate (λ_{DU}) [failures/hr]	3.80996E-10	4.6619E-10	
SRT [millisecond]	6		
Automatic Diagnostic Test Interval (TD) [hr]	4		
Useful Life [yr]	20		
Systematic Capability (SC)	3		
Safe Failure Fraction (SFF) [%]	99.97%	99.97%	
PFH	3.80996E-10	4.6619E-10	
PFD _{AVE}	10 yrs	1.66876E-05	2.04191E-05
Mission Time™	20 yrs	3.33753E-05	4.08383E-05
Diagnostic Coverage Average (DC _{AVE})	99.87%	99.91%	
Spurious Trip Rate (STR)	5.90E-06	—	
MTTF [years]	91.64	81.74	
MTTF _D [years]	253.96	213.76	

(1) (λ_{SD}) and (λ_{SU}) are calculated with assumption of Diagnostic Coverage of Safe Failure is same as Diagnostic Coverage of Dangerous Failure

1756-OBV8S Safety Data

[Table 9](#) lists the safety data for the 1756-OBV8S module.

Table 9 - 1756-OBV8S Module Safety Data

Attribute	Output Mode		
	Sourcing		Bipolar
	Point Operation Type		Point Operation Type
	Single	Dual	Single
Safety Function Architecture (HFT)	0	1	1
Safe Failure Rate (λ_s) [failures/hr]	1.16E-06	9.3E-07	9.5E-07
Safe Detected Failure Rate (λ_{SD}) ⁽¹⁾	1.16E-06	9.3E-07	9.5E-07
Safe Undetected Failure Rate (λ_{SU}) ⁽¹⁾	4.23E-10	5E-10	4.9E-10
Dangerous Failure Rate (λ_D) [failures/hr]	9.01E-07	5.9E-07	6.1E-07
Dangerous Detected Failure Rate (λ_{DD}) [failures/hr]	9.01E-07	5.9E-07	6.1E-07
Dangerous Undetected Failure Rate (λ_{DU}) [failures/hr]	3.29E-10	3.1E-10	3.1E-10
SRT [millisecond]	4.5		
Automatic Diagnostic Test Interval (TD) [hr]	4		
Useful Life [yr]	20		
Systematic Capability (SC)	3		
Safe Failure Fraction (SFF) [%]	99.98%	99.98%	99.98%
PFH	3.29E-10	3.1E-10	3.1E-10
PFDAVE	10 yrs	1.44E-05	1.4E-05
Mission Time™	20 yrs	2.89E-05	2.8E-05
Diagnostic Coverage Average (DC _{AVE})	99.96%	99.95%	99.95%
Spurious Trip Rate (STR)	3.99E-06	2.68E-06	2.79E-06
MTTF [years]	55.50	75.09	72.91
MTTF _D [years]	126.69	194.80	186.19

(1) (λ_{SD}) and (λ_{SU}) are calculated with assumption of Diagnostic Coverage of Safe Failure is same as Diagnostic Coverage of Dangerous Failure

Notes:

C

- configuration**
 - reset safety modules to out-of-box configuration 93
- configure**
 - with Logix Designer application 39
- connection** 7
- connection category**
 - 1756-IB16S and 1756-OBV8S modules 85
- connection types** 28
- controller organizer**
 - monitor tags 92
 - view module tags 92

D

- data transmission**
 - multicast method 28
- data types**
 - available with I/O modules 28

E

- EDS**
 - See electronic data sheet
- electronic data sheet** 7

F

- firmware**
 - obtain from PCDC 44

G

- general category**
 - 1756-IB16S and 1756-OBV8S modules 83

I

- I/O status indicators**
 - safety input modules 104
- input points category**
 - 1756-IB16S module 88

K

- keying**
 - mechanical 21, 22

L

- load current**
 - digital output module 67
- local I/O modules** 23, 31, 33
- locking tab** 21, 22
- Logix 5000 controllers**
 - ownership of I/O modules 24

Logix Designer application 39

- configuration overview 26
- connection types 28
- module definition
 - safety modules 84
- module tag definition 113
- name module tags 114
- replace a safety module 93 - 102
- reset safety modules to out-of-box configuration 93
- safety modules configuration 77 - 102
- safety network number 83
- tag editor 114
- view module tags 92

M

- masters** 7
- mechanical**
 - keying 21, 22
- module definition**
 - dialog box
 - safety modules 84
- module info category**
 - 1756-IB16S and 1756-OBV8S modules 87
- module location**
 - local I/O modules 23
 - remote I/O modules 24
- module tags**
 - definition 113
 - naming 114
 - tag editor 114
 - view 92
- multicast**
 - data broadcast method 31

N

- no load detection**
 - minimum time 67

O

- ODVA** 7
- out-of-box** 96
- ownership** 24

P

- PCDC**
 - obtain firmware 44
- PFD** 7
 - See probability of failure on demand.
- PFH** 7
 - See probability of failure per hour.
- probability of failure**
 - on demand 7
 - per hour 7
- proof test** 7

R

- remote I/O modules** 24, 32, 33
- removable terminal block** 10
- replace a safety module** 93 - 102
- reset safety modules to out-of-box configuration** 93
- RPI**
 - valid value 30
- RTB. See removable terminal block**

S

- safety category**
 - 1756-IB16S and 1756-OBV8S modules 86
- safety network number** 7, 83
- short circuit protection**
 - digital output modules 68
 - safety input modules 56
- slaves** 7
- SNN** 7
 - See safety network number.
- status indicators** 21, 22
 - safety input modules
 - I/O status indicators 104

T

- test output points category**
 - 1756-IB16S module 89
- thermal switch**
 - digital output modules 70
- troubleshooting**
 - connection category 107
 - general category 106
 - module Info category 107
 - module status indicators 21, 22
 - safety input modules
 - I/O status indicators 104
 - tag editor 110

V

- voltage range**
 - digital I/O module 10

W

- wiring connections**
 - removable terminal block 10

Rockwell Automation Support

Use the following resources to access support information.

Technical Support Center	Knowledgebase Articles, How-to Videos, FAQs, Chat, User Forums, and Product Notification Updates.	https://rockwellautomation.custhelp.com/
Local Technical Support Phone Numbers	Locate the phone number for your country.	http://www.rockwellautomation.com/global/support/get-support-now.page
Direct Dial Codes	Find the Direct Dial Code for your product. Use the code to route your call directly to a technical support engineer.	http://www.rockwellautomation.com/global/support/direct-dial.page
Literature Library	Installation Instructions, Manuals, Brochures, and Technical Data.	http://www.rockwellautomation.com/global/literature-library/overview.page
Product Compatibility and Download Center (PCDC)	Get help determining how products interact, check features and capabilities, and find associated firmware.	http://www.rockwellautomation.com/global/support/pcdc.page

Documentation Feedback

Your comments will help us serve your documentation needs better. If you have any suggestions on how to improve this document, complete the How Are We Doing? form at

https://literature.rockwellautomation.com/idc/groups/literature/documents/du/ra-du002_-en-e.pdf

Rockwell Automation maintains current product environmental information on its website at <http://www.rockwellautomation.com/rockwellautomation/about-us/sustainability-ethics/product-environmental-compliance.page>.

Allen-Bradley, Compact 5000, ControlLogix, GuardLogix, Kinetix, Logix 5000, PanelView, PowerFlex, RSNetWorx, Rockwell Automation, Rockwell Software, Safety Automation Builder, Stratix, and Studio 5000 Logix Designer are trademarks of Rockwell Automation, Inc.

CIP, CIP Safety, ControlNet, DeviceNet, and EtherNet/IP are trademarks of ODVA, Inc.

Trademarks not belonging to Rockwell Automation are property of their respective companies.

Rockwell Otomasyon Ticaret A.Ş., Kar Plaza İş Merkezi E Blok Kat:6 34752 İçerenköy, İstanbul, Tel: +90 (216) 5698400

www.rockwellautomation.com

Power, Control and Information Solutions Headquarters

Americas: Rockwell Automation, 1201 South Second Street, Milwaukee, WI 53204-2496 USA, Tel: (1) 414.382.2000, Fax: (1) 414.382.4444

Europe/Middle East/Africa: Rockwell Automation NV, Pegasus Park, De Kleetlaan 12a, 1831 Diegem, Belgium, Tel: (32) 2 663 0600, Fax: (32) 2 663 0640

Asia Pacific: Rockwell Automation, Level 14, Core F, Cyberport 3, 100 Cyberport Road, Hong Kong, Tel: (852) 2887 4788, Fax: (852) 2508 1846