

# PowerFlex ControlNet Adapters



**Allen-Bradley**

**20-COMM-C (Coax) Series A FRN 2.xxx, Series B FRN 3.xxx**  
**20-COMM-Q (Fiber) Series A FRN 3.xxx**

User Manual



## Important User Information

Solid state equipment has operational characteristics differing from those of electromechanical equipment. *Safety Guidelines for the Application, Installation and Maintenance of Solid State Controls* (Publication SGI-1.1 available from your local Rockwell Automation sales office or online at <http://www.rockwellautomation.com/literature>) describes some important differences between solid state equipment and hard-wired electromechanical devices. Because of this difference, and also because of the wide variety of uses for solid state equipment, all persons responsible for applying this equipment must satisfy themselves that each intended application of this equipment is acceptable.

In no event will Rockwell Automation, Inc. be responsible or liable for indirect or consequential damages resulting from the use or application of this equipment.

The examples and diagrams in this manual are included solely for illustrative purposes. Because of the many variables and requirements associated with any particular installation, Rockwell Automation, Inc. cannot assume responsibility or liability for actual use based on the examples and diagrams.

No patent liability is assumed by Rockwell Automation, Inc. with respect to use of information, circuits, equipment, or software described in this manual.

Reproduction of the contents of this manual, in whole or in part, without written permission of Rockwell Automation, Inc. is prohibited.

Throughout this manual, when necessary we use notes to make you aware of safety considerations.



**WARNING:** Identifies information about practices or circumstances that can cause an explosion in a hazardous environment, which may lead to personal injury or death, property damage, or economic loss.

---

**Important:** Identifies information that is critical for successful application and understanding of the product.

---



**ATTENTION:** Identifies information about practices or circumstances that can lead to personal injury or death, property damage, or economic loss. Attentions help you identify a hazard, avoid a hazard, and recognize the consequences.

---



**Shock Hazard** labels may be located on or inside the equipment (e.g., drive or motor) to alert people that dangerous voltage may be present.

---



**Burn Hazard** labels may be located on or inside the equipment (e.g., drive or motor) to alert people that surfaces may be at dangerous temperatures.

---

Allen-Bradley, Rockwell Software, Rockwell Automation, TechConnect, PowerFlex, SMC Flex, DPI, SCANport, Connected Components Workbench, DriveExplorer, DriveExecutive, DriveTools, ControlFLASH, RSLogix, RSNetWorx for ControlNet, ControlLogix, PLC-5, and SLC 500 are trademarks of Rockwell Automation, Inc.  
ControlNet is a trademark of ControlNet International, Ltd.  
Windows and Microsoft are registered trademarks of Microsoft Corporation.

## Summary of Changes

---

The information below summarizes the changes made to this manual since its last release (August 2007).

Description of Changes	Page
Reformatted document from half size (5.5 x 8.5 in.) to full size (8.5 x 11 in.)	Throughout manual
Added information about the Connected Components Workbench software configuration tool for drives and connected peripherals.	
Added information for use with PowerFlex 750-Series drives.	
Added information for use with PowerFlex Digital DC drives.	
In the Chapter 1 'User-Supplied Equipment' section, added the Connected Components Workbench software tool and related information. Also revised information for DriveExplorer and DriveExecutive software tools.	<a href="#">1-4</a>
Revised Figures 2.2 and 2.3 to show PowerFlex 700H/S Frames 9 and larger. Added ground tab details in Figure 2.3.	<a href="#">2-4</a> and <a href="#">2-5</a>
In Chapter 4, added new 'Using RSLinx Classic' section.	<a href="#">4-1</a>
Added titles to the controller I/O image tables (Table 5.A through Table 5.I) for easier referral.	<a href="#">5-3</a> to <a href="#">5-8</a>
Added footnotes to explicit messaging screen configuration tables for all controller type examples to clarify required settings for the Size in Words/Elements/Bytes fields when reading/writing to 16-bit and 32-bit parameters.	Throughout <a href="#">Chapter 6</a>
The 20-COMM-C and 20-COMM-Q adapter firmware revision 3.001 added support for use with PowerFlex 750-Series drives (revised DPI Parameter Object, Class Code 0x93, to include Ports 7 through 14).	Throughout <a href="#">Appendix C</a>

**Notes:**

<b>Preface</b>	<b>About This Manual</b>	
	Conventions Used in This Manual . . . . .	P-1
	Rockwell Automation Support . . . . .	P-2
	Additional Resources . . . . .	P-2
<b>Chapter 1</b>	<b>Getting Started</b>	
	Components . . . . .	1-1
	Features . . . . .	1-2
	Compatible Products . . . . .	1-3
	Required Equipment . . . . .	1-3
	Safety Precautions . . . . .	1-5
	Quick Start . . . . .	1-6
<b>Chapter 2</b>	<b>Installing the Adapter</b>	
	Preparing for an Installation . . . . .	2-1
	Setting the Node Address Switches . . . . .	2-2
	Connecting the Adapter to the Drive . . . . .	2-3
	Connecting the Adapter to the Network . . . . .	2-6
	Applying Power . . . . .	2-7
	Commissioning the Adapter . . . . .	2-9
<b>Chapter 3</b>	<b>Configuring the Adapter</b>	
	Configuration Tools . . . . .	3-1
	Using the PowerFlex 7-Class HIM to Access Parameters . . . . .	3-2
	Setting the Node Address . . . . .	3-3
	Setting the I/O Configuration . . . . .	3-3
	Setting Master-Slave Hierarchy . . . . .	3-4
	Setting the Reference Adjustment . . . . .	3-5
	Setting a Fault Action . . . . .	3-5
	Resetting the Adapter . . . . .	3-7
	Viewing the Adapter Status Using Parameters . . . . .	3-7
	Updating the Adapter Firmware . . . . .	3-8
<b>Chapter 4</b>	<b>Configuring the I/O</b>	
	Using RSLinx Classic Software . . . . .	4-1
	ControlLogix Controller Example . . . . .	4-2
	PLC-5 Controller Example . . . . .	4-24
	SLC 500 Controller Example . . . . .	4-30

<b>Chapter 5</b>	<b>Using the I/O</b>	
	About I/O Messaging . . . . .	5-1
	Understanding the I/O Image . . . . .	5-2
	Using Logic Command/Status . . . . .	5-8
	Using Reference/Feedback . . . . .	5-8
	Using Datalinks . . . . .	5-11
	Example Ladder Logic Program Information . . . . .	5-13
	ControlLogix Controller Example . . . . .	5-14
	PLC-5 Controller Example . . . . .	5-23
	SLC 500 Controller Example . . . . .	5-38
<b>Chapter 6</b>	<b>Using Explicit Messaging</b>	
	About Explicit Messaging . . . . .	6-2
	Performing Explicit Messages . . . . .	6-3
	ControlLogix Controller Examples . . . . .	6-4
	PLC-5 Controller Examples . . . . .	6-23
	SLC 500 Controller Examples . . . . .	6-40
<b>Chapter 7</b>	<b>Troubleshooting</b>	
	Understanding the Status Indicators . . . . .	7-1
	PORT Status Indicator . . . . .	7-2
	MOD Status Indicator . . . . .	7-2
	NET A and NET B Status Indicators . . . . .	7-3
	Viewing Adapter Diagnostic Items . . . . .	7-4
	Viewing and Clearing Events . . . . .	7-6
<b>Chapter 8</b>	<b>Using the Adapter in a DPI External Comms Kit (20-XCOMM-DC-BASE)</b>	
	Installing the Adapter . . . . .	8-1
	I/O Board Option (20-XCOMM-IO-OPT1) . . . . .	8-2
	Understanding the I/O Image (Drive + I/O Option) . . . . .	8-2
	Configuring the Adapter to Use the Optional I/O Data . . . . .	8-3
	Viewing Optional I/O Diagnostic Items . . . . .	8-4
<b>Appendix A</b>	<b>Specifications</b>	
	Communications . . . . .	A-1
	Electrical . . . . .	A-1
	Mechanical . . . . .	A-1
	Environmental . . . . .	A-2
	Regulatory Compliance . . . . .	A-2
<b>Appendix B</b>	<b>Adapter Parameters</b>	
	Parameter List . . . . .	B-1

---

<b>Appendix C</b>	<b>ControlNet Objects</b>	
	Identity Object . . . . .	C-2
	Assembly Object . . . . .	C-3
	Register Object . . . . .	C-4
	Parameter Object . . . . .	C-5
	Parameter Group Object . . . . .	C-7
	PCCC Object . . . . .	C-8
	DPI Device Object . . . . .	C-13
	DPI Parameter Object . . . . .	C-16
	DPI Fault Object . . . . .	C-22
	DPI Alarm Object . . . . .	C-24
	DPI Diagnostic Object . . . . .	C-26
	DPI Time Object . . . . .	C-28
	Host DPI Parameter Object . . . . .	C-30
<b>Appendix D</b>	<b>Logic Command/Status Words</b>	
	PowerFlex 70/700/700H, and 700L (with 700 Control) Drives . . . . .	D-1
	PowerFlex 700S (Phase II Control) and 700L (with 700S Control) Drives . . . . .	D-3
	PowerFlex 750-Series Drives . . . . .	D-5
	PowerFlex Digital DC Drives . . . . .	D-7

## Glossary

## Index

**Notes:**



## About This Manual

Topic	Page
<a href="#">Conventions Used in This Manual</a>	<a href="#">P-1</a>
<a href="#">Rockwell Automation Support</a>	<a href="#">P-2</a>
<a href="#">Additional Resources</a>	<a href="#">P-2</a>

This manual provides information about the adapter and using it with PowerFlex 7-Class (Architecture-Class) drives. The adapter can be used with other products that support a DPI™ adapter, such as the DPI External Comms Kit (20-XCOMM-DC-BASE). See the documentation for your product for specific information about how it works with the adapter.

### Conventions Used in This Manual

The following conventions are used throughout this manual:

- Parameter names are shown in the format **Parameter xx - [\*]**. The xx represents the parameter number. The \* represents the parameter name—for example **Parameter 01 - [DPI Port]**.
- Menu commands are shown in bold type face and follow the format **Menu > Command**. For example, if you read ‘Select **File > Open**’, you should click the **File** menu and then click the **Open** command.
- The firmware revision number (FRN) is displayed as FRN X.xxx, where ‘X’ is the major revision number and ‘xxx’ is the minor revision number.
- The screen images in this manual resulted from using the following software:
  - RSLinx® Classic software, version 2.59
  - RSNetWorx™ for ControlNet software, version 11.00
  - RSLogix™ 5 software, version 7.20
  - RSLogix 500 software, version 7.20
  - RSLogix 5000 software, version 20.00

Different versions of the software may have screens that vary in appearance, and differences in procedures.

## Rockwell Automation Support

Rockwell Automation offers support services worldwide, with over 75 sales and support offices, over 500 authorized distributors, and over 250 authorized systems integrators located through the United States alone. In addition, Rockwell Automation representatives are in every major country in the world.

### Local Product Support

Contact your local Rockwell Automation, Inc. representative for:

- Sales and order support
- Product technical training
- Warranty support
- Support service agreements

### Technical Product Assistance

For technical assistance, please review the information in [Chapter 7, Troubleshooting](#), first. If you still have problems, then access the Allen-Bradley Technical Support website at [www.ab.com/support/abdrives](http://www.ab.com/support/abdrives) or contact Rockwell Automation.

## Additional Resources

These documents contain additional information concerning related products from Rockwell Automation.

Resource	Description
PowerFlex 7-Class DPI (Drive Peripheral Interface) Network Communication Adapter Installation Instructions, publication <a href="#">20COMM-IN004</a>	Information on installing PowerFlex® 20-COMM-x Network Communication Adapters.
ControlNet Coax Media Planning and Installation Guide, publication <a href="#">CNET-IN002</a>	Information on the required components of a ControlNet™ coax media system, determining your system, and installing the required components.
ControlNet Fiber Media Planning and Installation Guide, publication <a href="#">CNET-IN001</a>	Basic information for fiber cable planning and installation.
Connected Components Workbench website <a href="http://www.ab.com/support/abdrives/webupdate/software.html">http://www.ab.com/support/abdrives/webupdate/software.html</a> , and online help <sup>(1)</sup>	Information on the Connected Components Workbench software tool—and includes a link for <b>free</b> software download.
DriveExplorer website <a href="http://www.ab.com/drives/driveexplorer">http://www.ab.com/drives/driveexplorer</a> , and online help <sup>(1)</sup>	Information on using the DriveExplorer™ software tool.
DriveExecutive website <a href="http://www.ab.com/drives/drivetools">http://www.ab.com/drives/drivetools</a> , and online help <sup>(1)</sup>	Information on using the DriveExecutive™ software tool.
PowerFlex 20-HIM-A3/-A5/-C3S/-C5S HIM Quick Reference, publication <a href="#">20HIM-QR001</a>	Information on using PowerFlex 20-HIM-A3, 20-HIM-A5, 20-HIM-C3S, and 20-HIM-C5S HIMs.
PowerFlex 20-HIM-A6/C6S HIM (Human Interface Module) User Manual, publication <a href="#">20HIM-UM001</a>	Information on installing and using PowerFlex 20-HIM-A6 and 20-HIM-C6S HIMs.
PowerFlex 70 User Manual, publication <a href="#">20A-UM001</a> PowerFlex 70/700 Reference Manual, publication <a href="#">PFLEX-RM001</a> PowerFlex 70 Enhanced Control and 700 Vector Control Reference Manual, publication <a href="#">PFLEX-RM004</a>	Information on installing and programming PowerFlex 70 standard control and enhanced control drives.
PowerFlex 700 Series A User Manual, publication <a href="#">20B-UM001</a> PowerFlex 700 Series B User Manual, publication <a href="#">20B-UM002</a> PowerFlex 70/700 Reference Manual, publication <a href="#">PFLEX-RM001</a> PowerFlex 70 Enhanced Control and 700 Vector Control Reference Manual, publication <a href="#">PFLEX-RM004</a>	Information on installing and programming PowerFlex 700 standard control and vector control Series A drives, and PowerFlex 700 vector control Series B drives.
PowerFlex 700H Installation Instructions, publication <a href="#">PFLEX-IN006</a> PowerFlex 700H Programming Manual, publication <a href="#">20C-PM001</a>	Information on installing and programming PowerFlex 700H drives.

Resource	Description
PowerFlex 700S w/Phase I Control Installation Manual (Frames 1...6), publication <a href="#">20D-IN024</a> PowerFlex 700S w/Phase I Control Installation Manual (Frames 9 and 10), publication <a href="#">PFLEX-IN006</a> PowerFlex 700S w/Phase I Control User Manual (All Frame Sizes), publication <a href="#">20D-UM001</a> PowerFlex 700S w/Phase I Control Reference Manual, publication <a href="#">PFLEX-RM002</a> PowerFlex 700S w/Phase II Control Installation Manual (Frames 1...6), publication <a href="#">20D-IN024</a> PowerFlex 700S w/Phase II Control Installation Manual (Frames 9...14), publication <a href="#">PFLEX-IN006</a> PowerFlex 700S w/Phase II Control Programming Manual (All Frame Sizes), publication <a href="#">20D-PM001</a> PowerFlex 700S w/Phase II Control Reference Manual, publication <a href="#">PFLEX-RM003</a>	Information on installing and programming PowerFlex 700S drives.
PowerFlex 700L User Manual, publication <a href="#">20L-UM001</a>	Information on installing and programming PowerFlex 700L Liquid-Cooled AC drives.
PowerFlex 750-Series Drive Installation Instructions, publication <a href="#">750-IN001</a> PowerFlex 750-Series Drive Programming Manual, publication <a href="#">750-PM001</a> PowerFlex 20-750-CNETC Coaxial ControlNet Option Module, publication <a href="#">750COM-UM003</a> 20-750-20COMM and 20-750COMM-F1 Communication Carrier Cards Installation Instructions, publication <a href="#">750COM-IN001</a>	Information on installing and programming PowerFlex 750-Series AC drives.
PowerFlex Digital DC Drive User Manual, publication <a href="#">20P-UM001</a>	Information on installing and programming PowerFlex Digital DC drives.
Getting Results with RSLinx Guide, publication <a href="#">LINX-GR001</a> , and online help <sup>(1)</sup>	Information on using RSLinx Classic software.
RSLogix Emulate 5/500 Getting Results Guide, publication <a href="#">EMULAT-GR002</a> , and online help <sup>(1)</sup>	Information on installing and navigating the RSLogix Emulate software for ladder logic programming with Allen-Bradley PLC-5 and SLC 500 processors.
RSLogix 500 Getting Results Guide, publication <a href="#">LG500-GR002</a> , and online help <sup>(1)</sup>	Information on using the RSLogix 500 software tool.
RSLogix 5000 PIDE Autotuner Getting Results Guide, publication <a href="#">PIDE-GR001</a> , and online help <sup>(1)</sup>	Information on using the RSLogix 5000 software tool.
RSNetWorx for ControlNet Getting Results Guide, publication <a href="#">CNET-GR001</a> , and online help <sup>(1)</sup>	Information on installing and navigating the RSNetWorx for ControlNet™ software, effectively using it, and accessing and navigating the online help.
ControlNet Network Configuration User Manual, publication <a href="#">CNET-UM001</a>	Information on using ControlNet communication modules with the Logix 5000 controller.
ControlNet PLC-5 Programmable Controllers User Manual, publication <a href="#">1785-UM022</a>	Information on installing 1785-L20C15, 1785-L40C15, 1785-L46C15, and 1785-L80C15 programmable controllers, and configuring and using their features.
SLC 500 Modular Hardware Style User Manual, publication <a href="#">1747-UM011</a>	Information on installing the controller, and an overview of the SLC 500 programmable controller system.

<sup>(1)</sup> The online help is installed with the software.

Documentation can be obtained online at <http://literature.rockwellautomation.com>. To order paper copies of technical documentation, contact your local Rockwell Automation distributor or sales representative.

To find your local Rockwell Automation distributor or sales representative, visit <http://www.rockwellautomation.com/locations>.

For information such as firmware updates or answers to drive-related questions, go to the Drives Service & Support website at <http://www.ab.com/support/abdrives> and click on the Downloads or Knowledgebase link.

**Notes:**

## Getting Started

The adapter is intended for installation into a PowerFlex 7-Class drive and is used for network communication. The 20-COMM-C Series B coax adapter, firmware 2.xxx or later, or 20-COMM-Q Series A fiber adapter, firmware 2.xxx or later, can also be installed in an External DPI Comms Kit (20-XCOMM-DC-BASE).

For PowerFlex 750-Series drives, we recommend using the 20-750-CNETC Coaxial ControlNet option module instead of the 20-COMM-C adapter. However, this manual does include information on using the 20-COMM-C or 20-COMM-Q adapter with PowerFlex 750-Series drives—but there are operating limitations. For details, see [Compatible Products on page 1-3](#).

Topic	Page
<a href="#">Components</a>	<a href="#">1-1</a>
<a href="#">Features</a>	<a href="#">1-2</a>
<a href="#">Compatible Products</a>	<a href="#">1-3</a>
<a href="#">Required Equipment</a>	<a href="#">1-3</a>
<a href="#">Safety Precautions</a>	<a href="#">1-5</a>
<a href="#">Quick Start</a>	<a href="#">1-6</a>

## Components

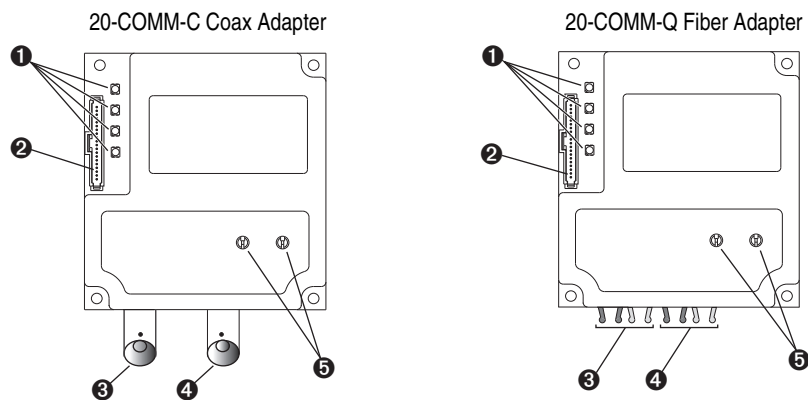

Item	Part	Description
❶	Status Indicators	Four status indicators that indicate the status of the DPI, the adapter, and network connection. See <a href="#">Chapter 7, Troubleshooting</a> .
❷	DPI Connector	A 20-pin, single-row shrouded male header. An Internal Interface cable is connected to this connector and a connector on the drive.
❸	20-COMM-C: Channel A Coax Receptacle 20-COMM-Q: Channel A Fiber Receptacles	Channel A BNC connection to the network. Channel A V-pin connection to the network.
❹	20-COMM-C: Channel B Coax Receptacle 20-COMM-Q: Channel B Fiber Receptacles	Channel B (redundant) BNC connection to the network. Channel B (redundant) V-pin connection to the network.
❺	Node Address Switches	Switches to set the node address. See <a href="#">Setting the Node Address Switches on page 2-2</a> .

## Features

The features of the adapter include the following:

- Typical mounting in a PowerFlex 7-Class drive. The 20-COMM-C Series B coax adapter, firmware 2.xxx or later, or 20-COMM-Q Series A fiber adapter, firmware 2.xxx or later, can also be installed in a DPI External Comms Kit and used with the kit's optional I/O board. See [Chapter 8, Using the Adapter in a DPI External Comms Kit \(20-XCOMM-DC-BASE\)](#) for more information.

### DPI External Comms Kit Compatibility

Adapter			Operation With	
Type	Series	Firmware Revision	DPI External Comms Kit (20-XCOMM-DC-BASE)	Optional I/O Board (20-XCOMM-IO-OPT1)
20-COMM-C (coaxial)	A	1.xxx	No	No
		2.xxx	Yes	No
	B	1.xxx	No	No
		2.xxx and later	Yes	Yes
20-COMM-Q (fiber)	A	1.xxx	No	No
		2.xxx and later	Yes	Yes

- Captive screws to secure and ground the adapter to the drive or, when mounted in a DPI External Comms Kit, to the kit's metal enclosure.
- Compatibility with various configuration tools to configure the adapter and connected host drive, including the following tools:
  - PowerFlex HIM (Human Interface Module) on the drive, if available
  - Connected Components Workbench software, version 1.02 or later
  - DriveExplorer software, version 2.01 or later
  - DriveExecutive software, version 3.01 or later
- Switches to set a node address before applying power to the PowerFlex drive, or you can disable the switches and use an adapter parameter to configure the node address.
- Status indicators that report the status of the drive communications, the adapter, and network. They are visible when the drive cover is open or closed.
- Parameter-configured I/O (Logic Command/Reference and up to four pairs of Datalinks) to accommodate application requirements.
- Explicit Messaging support.
- Master-Slave hierarchy that can be configured to transmit data to and from a controller on the network.
- User-defined fault actions to determine how the adapter and connected PowerFlex drive respond to the following:
  - I/O messaging communication disruptions (Comm Flt Action)
  - Controllers in idle mode (Idle Flt Action)
- Access to any PowerFlex drive and its connected peripherals on the network to which the adapter is connected.

## Compatible Products

At the time of publication, the adapter is compatible with the following products:

• PowerFlex 70 drives with standard or enhanced control	• PowerFlex 750-Series drives <sup>(1)</sup>
• PowerFlex 700 drives with standard or vector control	• PowerFlex Digital DC drives
• PowerFlex 700H drives	• DPI External Comms Kit
• PowerFlex 700S drives with Phase I or Phase II control	• SMC™ Flex smart motor controllers
• PowerFlex 700L drives with 700 vector control or 700S control	• SMC-50 smart motor controllers

<sup>(1)</sup> The 20-COMM-C or 20-COMM-Q adapter can be used with PowerFlex 750-Series drives, but the adapter must have firmware revision 3.001 or later. Also, the adapter has the following limitations and differences:

- Only the first 16 bits of the Logic Command and Logic Status words are used.
- Speed Reference and Feedback scaling are Hz (or RPM) x 1000 (depending on the setting of drive parameter 300 - [Speed Units]).

Instead of using the 20-COMM-C adapter with the PowerFlex 750-Series drive, the 20-750-CNETC Coaxial ControlNet option module should be used whenever possible. Please see the PowerFlex 750-Series AC Drives Programming Manual, publication 750-PM001, for drive parameter information and the 20-750-CNETC ControlNet Option Module User Manual, publication 750COM-UM003, for network communication module information.

## Required Equipment

Some of the equipment that is required for use with the adapter is shipped with the adapter, but some you must supply yourself.

### Equipment Shipped with the Adapter

When you unpack the adapter, verify that the package includes the following:

- One 20-COMM-C coax or 20-COMM-Q fiber adapter
- One 2.54 cm (1 in.) long and one 15.24 cm (6 in.) long Internal Interface cable (only one cable is needed to connect the adapter to the drive; for which cable to use, see [Figure 2.2 on page 2-4](#))
- One PowerFlex 7-Class DPI (Drive Peripheral Interface) Network Communication Adapter Installation Instructions, publication 20COMM-IN004



**TIP:** When mounting the 20-COMM-C or 20-COMM-Q adapter in a PowerFlex 750-Series drive, you must use a 20-750-20COMM or 20-750-20COMM-F1 Communication Carrier Card, publication 750COM-IN001—and the 20-COMM-C or 20-COMM-Q adapter must have firmware revision 3.001 or later.

### User-Supplied Equipment

To install and configure the adapter, you must supply the following:

- A small flathead screwdriver
- ControlNet cable (for details, see to the ControlNet Coax Media Planning and Installation Guide, publication CNET-IN002, or the ControlNet Fiber Media Planning and Installation Guide, publication CNET-IN001)

- ❑ Drive and adapter configuration tool, such as the following:
  - PowerFlex 20-HIM-xx HIM
  - RSNetWorx for ControlNet software, version 6.00 or later
  - Connected Components Workbench software, version 1.02 or later

Connected Components Workbench is the recommended stand-alone software tool for use with PowerFlex drives. You can obtain a **free copy** by:

- Internet download at <http://www.ab.com/support/abdrives/webupdate/software.html>
- Requesting a DVD at <http://www.ab.com/onecontact/controllers/micro800/>

Your local distributor may also have copies of the DVD available.

Connected Components Workbench software cannot be used to configure SCANport-based drives or Bulletin 160 drives.

- DriveExplorer software, version 2.01 or later

This software tool has been discontinued and is now available as **freeware** at <http://www.ab.com/support/abdrives/webupdate/software.html>. There are no plans to provide future updates to this tool and the download is being provided ‘as-is’ for users that lost their DriveExplorer CD, or need to configure legacy products not supported by Connected Components Workbench software.

- DriveExecutive software, version 3.01 or later

A Lite version of DriveExecutive software ships with RSLogix 5000, RSNetWorx MD, FactoryTalk AssetCentre, and IntelliCENTER software. All other versions are purchasable items:

- 9303-4DTE01ENE Drive Executive software
- 9303-4DTS01ENE DriveTools SP Suite (includes DriveExecutive and DriveObserver software)
- 9303-4DTE2S01ENE DriveExecutive software upgrade to DriveTools SP Suite (adds DriveObserver software)

DriveExecutive software updates (patches, and so forth) can be obtained at <http://www.ab.com/support/abdrives/webupdate/software.html>. It is highly recommended that you periodically check for and install the latest update.

- ❑ Controller configuration tool, such as RSLogix 5, RSLogix 500, or RSLogix 5000 software
- ❑ A computer connection to the ControlNet network via a communication card, such as 1784-PCC, 1784-KTCX, or 1770-KFC



## Safety Precautions

Please read the following safety precautions carefully.



**ATTENTION:** Risk of injury or death exists. The PowerFlex drive may contain high voltages that can cause injury or death. Remove all power from the PowerFlex drive, and then verify power has been discharged before installing or removing an adapter.



**ATTENTION:** Risk of injury or equipment damage exists. Only personnel familiar with drive and power products and the associated machinery should plan or implement the installation, start up, configuration, and subsequent maintenance of the product using an adapter. Failure to comply may result in injury and/or equipment damage.



**ATTENTION:** Risk of equipment damage exists. The adapter contains electrostatic discharge (ESD) sensitive parts that can be damaged if you do not follow ESD control procedures. Static control precautions are required when handling the adapter. If you are unfamiliar with static control procedures, see Guarding Against Electrostatic Damage, publication 8000-4.5.2.



**ATTENTION:** Risk of injury or equipment damage exists. If the adapter is transmitting control I/O to the drive, the drive may fault when you reset the adapter. Determine how your drive will respond before resetting an adapter.



**ATTENTION:** Risk of injury or equipment damage exists. **Parameters 10 - [Comm Flt Action] and 11 - [Idle Flt Action]** let you determine the action of the adapter and connected drive if communication is disrupted or the controller is idle. By default, these parameters fault the drive. You can set these parameters so that the drive continues to run, however, precautions should be taken to verify that the settings of these parameters do not create a risk of injury or equipment damage. When commissioning the drive, verify that your system responds correctly to various situations (for example, a disconnected cable or a controller in idle state).



**ATTENTION:** Risk of injury or equipment damage exists. When a system is configured for the first time, there may be unintended or incorrect machine motion. Disconnect the motor from the machine or process during initial system testing.



**ATTENTION:** Risk of injury or equipment damage exists. The examples in this publication are intended solely for purposes of example. There are many variables and requirements with any application. Rockwell Automation does not assume responsibility or liability (to include intellectual property liability) for actual use of the examples shown in this publication.

## Quick Start

This section is provided to help experienced users quickly start using the adapter. If you are unsure how to complete a step, refer to the referenced chapter.

Step	Action	See
1	Review the safety precautions for the adapter.	Throughout this manual
2	Verify that the PowerFlex drive is properly installed.	Drive User Manual
3	<p>Install the adapter.</p> <ol style="list-style-type: none"> <li>Verify that the PowerFlex drive is not powered.</li> <li>Connect the adapter to the drive with the Internal Interface cable.</li> <li>Use the captive screws to secure and ground the adapter to the drive.</li> <li>Connect the adapter to the network with a ControlNet cable.</li> </ol> <p><b>NOTE:</b> When installing the adapter in either of the following products, see the listed publication for instructions:</p> <ul style="list-style-type: none"> <li>DPI External Comms Kit—see the 20-XCOMM-DC-BASE Installation Instructions, publication 20COMM-IN001, supplied with the kit.</li> <li>PowerFlex 750-Series drive—see the 20-750-20COMM and 20-750-20COMM-F1 Communication Carrier Cards Installation Instructions, publication 750COM-IN001, supplied with the card.</li> </ul>	<p>PowerFlex 7-Class DPI Network Communication Adapter Installation Instructions, publication 20COMM-IN004, and</p> <p><a href="#">Chapter 2, Installing the Adapter</a></p>
4	<p>Apply power to the adapter.</p> <ol style="list-style-type: none"> <li>Verify that the adapter is installed correctly. The adapter receives power from the drive.</li> <li>Apply power to the drive. The status indicators should be green. If they flash red, there is a problem. See <a href="#">Chapter 7, Troubleshooting</a>.</li> <li>Configure and verify key drive parameters.</li> </ol>	<a href="#">Chapter 2, Installing the Adapter</a>
5	<p>Configure the adapter for your application.</p> <p>Set adapter parameters for the following functions as required by your application:</p> <ul style="list-style-type: none"> <li>Node address</li> <li>I/O configuration</li> <li>Master-Slave hierarchy</li> <li>Fault actions</li> </ul>	<a href="#">Chapter 3, Configuring the Adapter</a>
6	<p>Configure the controller to communicate with the adapter.</p> <p>Use configuration tools, such as RSNetWorx for ControlNet software and RSLogix software, to configure the master on the network to recognize the adapter and drive.</p>	<a href="#">Chapter 4, Configuring the I/O</a>
7	<p>Create a ladder logic program.</p> <p>Use a controller configuration tool, such as RSLogix software, to create a ladder logic program that enables you to do the following:</p> <ul style="list-style-type: none"> <li>Control the connected drive, via the adapter, by using I/O.</li> <li>Monitor or configure the drive using explicit messages.</li> </ul>	<p><a href="#">Chapter 5, Using the I/O</a></p> <p><a href="#">Chapter 6, Using Explicit Messaging</a></p>

---

## Installing the Adapter

This chapter provides instructions for installing the adapter in a PowerFlex 7-Class drive. The 20-COMM-C Series B coax adapter, firmware revision 2.xxx or later, or 20-COMM-Q Series A fiber adapter, firmware revision 2.xxx or later, can also be installed in a DPI External Comms Kit. In this case, see [Chapter 8](#) or the 20-XCOMM-DC-BASE Installation Instructions, publication 20COMM-IN001, supplied with the kit.

Topic	Page
<a href="#">Preparing for an Installation</a>	<a href="#">2-1</a>
<a href="#">Setting the Node Address Switches</a>	<a href="#">2-2</a>
<a href="#">Connecting the Adapter to the Drive</a>	<a href="#">2-3</a>
<a href="#">Connecting the Adapter to the Network</a>	<a href="#">2-6</a>
<a href="#">Applying Power</a>	<a href="#">2-7</a>
<a href="#">Commissioning the Adapter</a>	<a href="#">2-9</a>

### Preparing for an Installation

Before installing the adapter, do the following:

- Read the ControlNet Coax Media Planning and Installation Guide, publication CNET-IN002, or the ControlNet Fiber Media Planning and Installation Guide, publication CNET-IN001. These publications provide information on network basics, selecting cables, and setting up a network.
- Verify that you have all required equipment. See [Required Equipment on page 1-3](#).



**ATTENTION:** Risk of equipment damage exists. The adapter contains electrostatic discharge (ESD) sensitive parts that can be damaged if you do not follow ESD control procedures. Static control precautions are required when handling the adapter. If you are unfamiliar with static control procedures, see Guarding Against Electrostatic Damage, publication 8000-4.5.2.

---

## Setting the Node Address Switches

Set the adapter Node Address switches ([Figure 2.1](#)) by rotating the switches to the desired value for each digit.

**Important:** Each node on the ControlNet network must have a unique address. Set the node address before power is applied because the adapter uses the node address it detects when it first receives power. To change a node address, you must set the new value and then remove and reapply power to (or reset) the adapter.

**Figure 2.1** Setting Adapter Node Address Switches

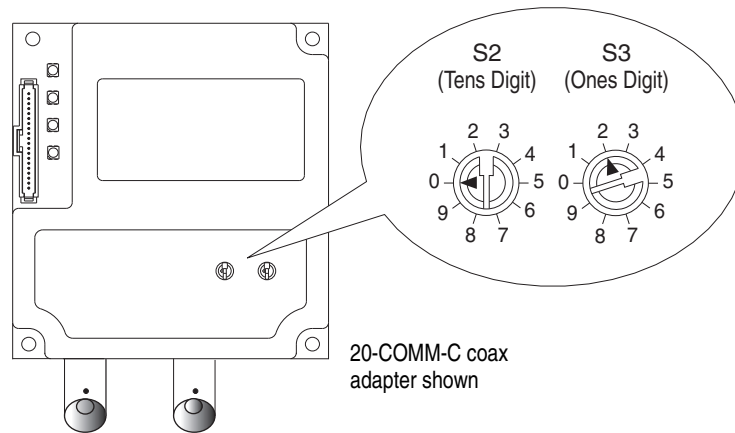

Setting	Description
00	If the Node Address switches are set to '00' (Program), the adapter uses the value stored in <b>Parameter 03 - [CN Addr Cfg]</b> for the node address. See <a href="#">Setting the Node Address on page 3-3</a> .
01...99	Node address used by the adapter. The default switch setting is 02.

The Node Address switch settings can be verified by viewing **Parameter 04 - [CN Addr Act]** or Diagnostic Device Item number 27 ([page 7-5](#)) with any of the following drive configuration tools:

- PowerFlex HIM
- Connected Components Workbench software, version 1.02 or later
- DriveExplorer software, version 2.01 or later
- DriveExecutive software, version 3.01 or later

## Connecting the Adapter to the Drive



**ATTENTION:** Risk of injury or death exists. The PowerFlex drive may contain high voltages that can cause injury or death. Remove power from the drive, and then verify power has been discharged before installing or removing the adapter.

1. Remove power from the drive.
2. Use static control precautions.
3. Remove the drive cover or open the drive door.
4. Connect the Internal Interface cable to the DPI port on the drive and then to the DPI connector on the adapter (see [Figure 2.2](#)).
5. Secure and ground the adapter to the drive (see [Figure 2.3](#)) by doing the following:
  - On a PowerFlex 70 drive, fold the Internal Interface cable behind the adapter and mount the adapter on the drive using the four captive screws.
  - On a PowerFlex 700, PowerFlex 700H or PowerFlex 700S drive, mount the adapter on the drive using the four captive screws.

**Important:** Tighten all screws to properly ground the adapter.  
Recommended torque is 0.9 N•m (8.0 lb•in).

**Figure 2.2 DPI Ports and Internal Interface Cables**

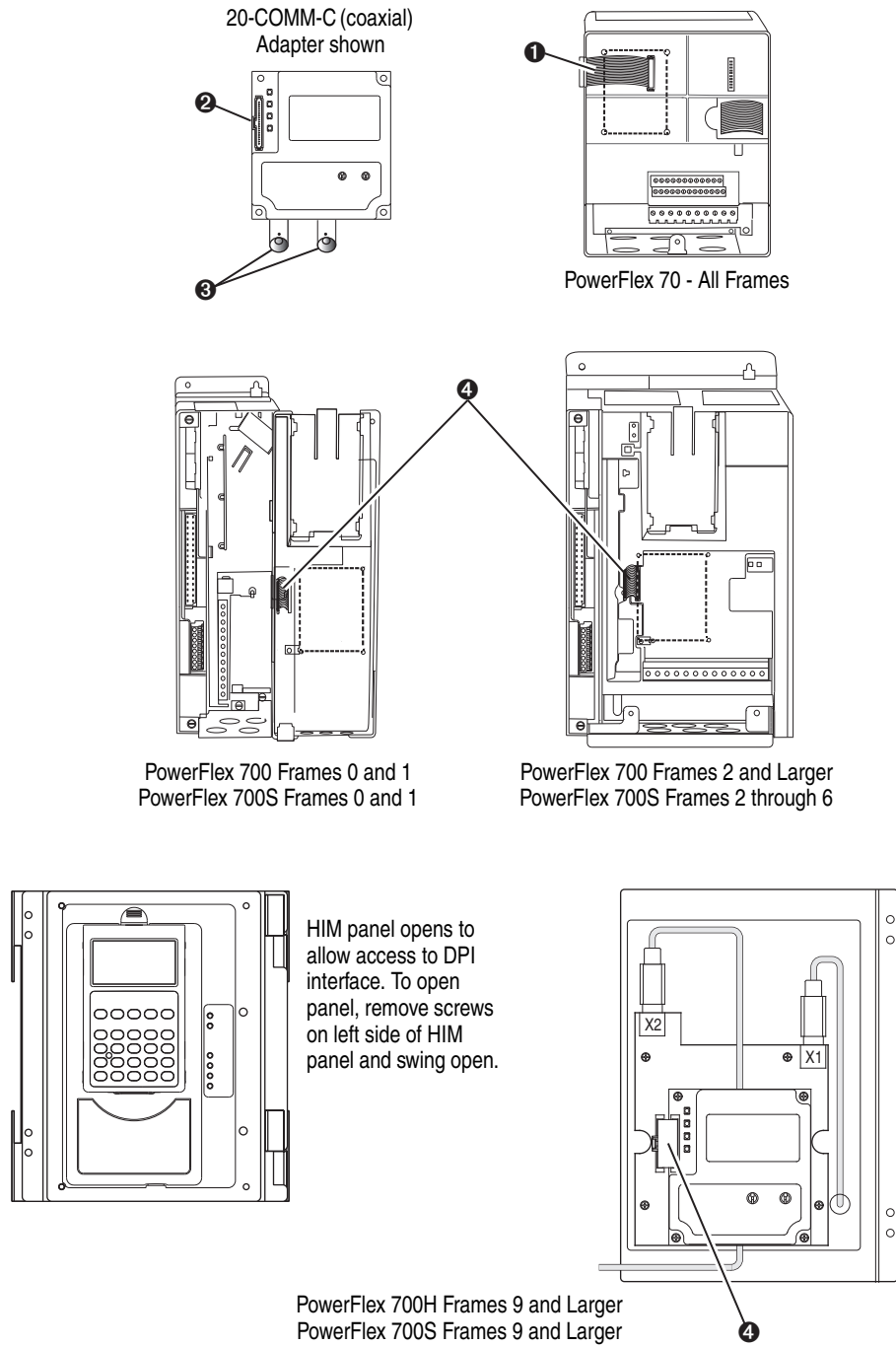

Item	Description
1	15.24 cm (6 in.) Internal Interface cable
2	DPI Connector
3	ControlNet cable(s)
4	2.54 cm (1 in.) Internal Interface cable

**Figure 2.3 Mounting and Grounding the Adapter**

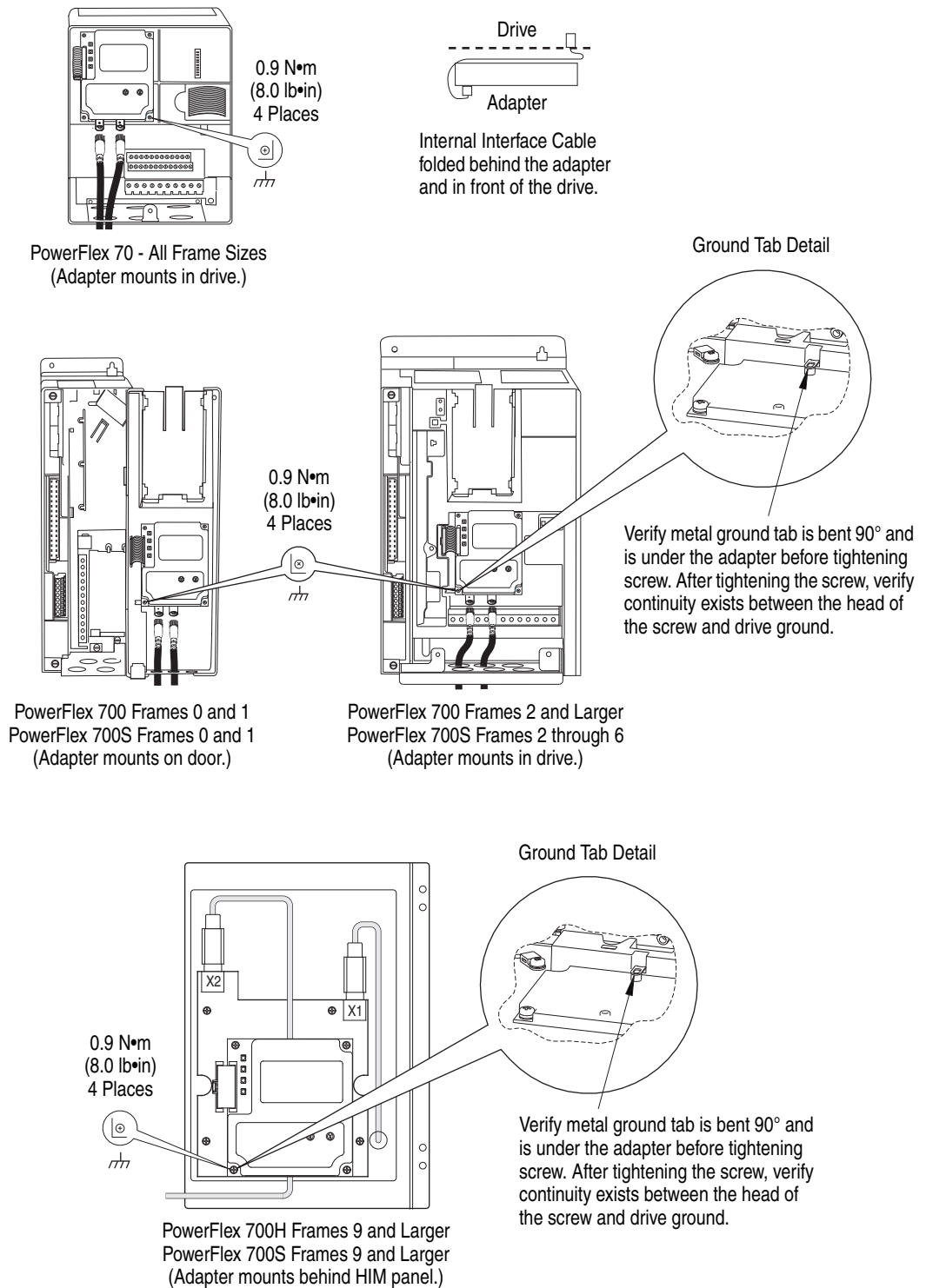

**NOTE:** When installing the adapter in a PowerFlex 750-Series drive, see the 20-750-20COMM and 20-750-20COMM-F1 Communication Carrier Cards Installation Instructions, publication 750COM-IN001, supplied with the card.

## Connecting the Adapter to the Network



**ATTENTION:** Risk of injury or death exists. The PowerFlex drive may contain high voltages that can cause injury or death. Remove power from the drive, and then verify power has been discharged before installing or removing the adapter.

1. Remove power from the drive.
2. Use static control precautions.
3. Connect one end of a ControlNet cable to the network. See [Figure 2.4](#) or [Figure 2.5](#) for an example of wiring to a ControlNet network.

**Figure 2.4 Coax Network Wiring Example**

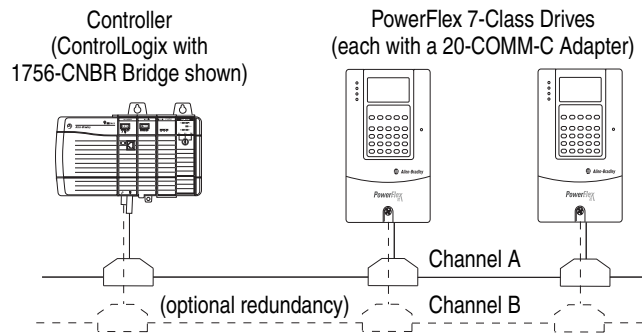

**Figure 2.5 Fiber Network Wiring Example**

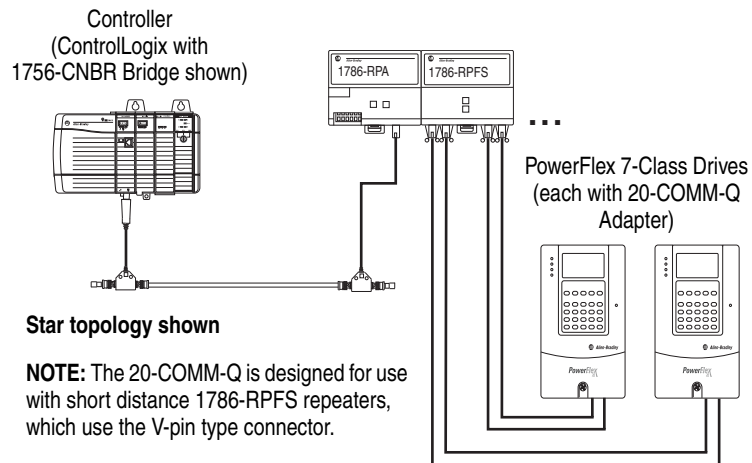

4. Route the other end of the ControlNet cable through the bottom of the drive ([Figure 2.3](#)), and insert its ControlNet cable plug into the mating adapter receptacle. A 1786-TPS (straight tap) is recommended for connection to the 20-COMM-C (coax) adapter.

For information about network system design and component installation, see the following publications:

- ControlNet Coax Media Planning and Installation Guide, publication CNET-IN002
- ControlNet Fiber Media Planning and Installation Guide, publication CNET-IN001



## Applying Power



**ATTENTION:** Risk of equipment damage, injury, or death exists. Unpredictable operation may occur if you fail to verify that parameter settings are compatible with your application. Verify that settings are compatible with your application before applying power to the drive.

Install the drive cover or close the drive door, and apply power to the drive. The adapter receives its power from the connected drive. When you apply power to the adapter for the first time, its topmost 'PORT' status indicator should be steady green or flashing green after an initialization. If it is red, there is a problem. See [Chapter 7, Troubleshooting](#).

## Start-Up Status Indications

Status indicators for the drive and communication adapter can be viewed on the front of the drive ([Figure 2.6](#)) after power has been applied. Possible start-up status indications are shown in [Table 2.A](#).

**Figure 2.6** Drive and Adapter Status Indicators (location on drive may vary)

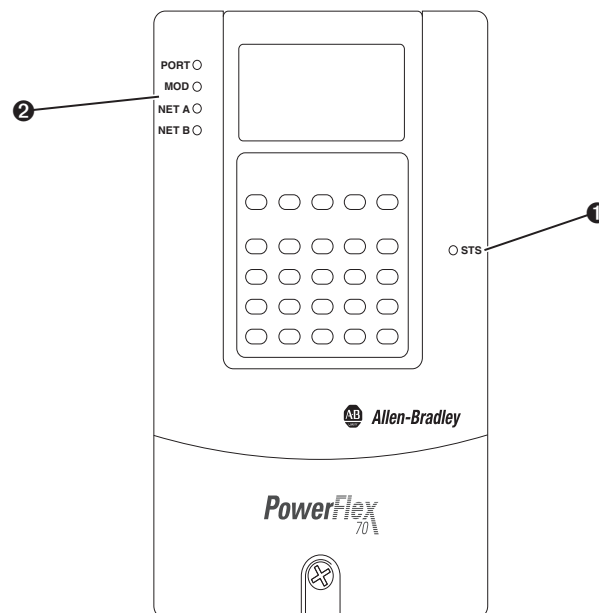

**Table 2.A Drive and Adapter Start-Up Status Indicators**

Item	Name	Color	State	Description
<b>Drive STS Indicator</b>				
❶	STS (Status)	Green	Flashing	Drive ready but not running, and no faults are present.
			Steady	Drive running, no faults are present.
		Yellow	Flashing, drive stopped	An inhibit condition exists – the drive cannot be started. Check drive Parameter 214 - [Start Inhibits].
			Flashing, drive running	An intermittent type 1 alarm condition is occurring. Check drive Parameter 211 - [Drive Alarm 1].
			Steady, drive running	A continuous type 1 alarm condition exists. Check drive Parameter 211 - [Drive Alarm 1].
		Red	Flashing	A fault has occurred.
Steady	A non-resettable fault has occurred.			
<b>Adapter Status Indicators</b>				
❷	PORT	Green	Flashing	Normal operation. The adapter is establishing an I/O connection to the drive. It will turn steady green or red.
			Steady	Normal operation. The adapter is properly connected and communicating with the drive.
	MOD	Green	Flashing	Normal operation. The adapter is operating but is not transferring I/O data to a controller.
			Steady	Normal operation. The adapter is operating and transferring I/O data to a controller.
	NET A NET B	Green	Flashing	A temporary channel error has occurred or the channel is in listen-only mode.
			Steady	Normal operation for that channel. The adapter is properly connected and communicating on the network.
		Red	Flashing	The channel is not receiving network activity.
		Green/ Red	Flashing alternately	There is an invalid link configuration for that channel.

For more details on status indicator operation, see [page 7-2](#) and [page 7-3](#).

### Configuring and Verifying Key Drive Parameters

The PowerFlex 7-Class drive can be separately configured for the control and Reference functions in various combinations. For example, you could set the drive to have its control come from a peripheral or terminal block with the Reference coming from the network. Or you could set the drive to have its control come from the network with the Reference coming from another peripheral or terminal block. Or you could set the drive to have both its control and Reference come from the network.

The following steps in this section assume that the drive will receive the Logic Command and Reference from the network.

1. Use drive Parameter 090 - [Speed Ref A Sel] to set the drive speed Reference to '22' (DPI Port 5).

2. If hard-wired discrete digital inputs are not used to control the drive, verify that unused digital input drive Parameters 361 - [Dig In1 Sel] and 362 - [Dig In2 Sel] are set to '0' (Not Used).
3. Verify that drive Parameter 213 - [Speed Ref Source] is reporting that the source of the Reference to the drive is '22' (DPI Port 5).

This ensures that any Reference commanded from the network can be monitored by using drive Parameter 002 - [Commanded Speed]. If a problem occurs, this verification step provides the diagnostic capability to determine whether the drive/adapter or the network is the cause.



**TIP:** For PowerFlex 750-Series drives, use drive Parameter 545 - [Speed Ref A Sel] to set the drive speed Reference:

- a. Set the Port field to 'Port 0 - PowerFlex 75x'.
- b. Set the Parameter field to point to the port (slot) in which the 20-COMM-C adapter/20-750-20COMM Communication Carrier Card are installed (for example, '876 - Port 6 Reference').

The number '876' in the Parameter field of the example is the parameter in the drive that points to the port.

## Commissioning the Adapter

To commission the adapter, you must set a unique node address on the network. See [Setting the Node Address on page 3-3](#) for details.

**Important:** New settings for some adapter parameters are recognized only when power is applied to the adapter or it is reset. After you change parameter settings, cycle power or reset the adapter.

**Notes:**

## Configuring the Adapter

This chapter provides instructions and information for setting the parameters in the adapter.

Topic	Page
<a href="#">Configuration Tools</a>	<a href="#">3-1</a>
<a href="#">Using the PowerFlex 7-Class HIM to Access Parameters</a>	<a href="#">3-2</a>
<a href="#">Setting the Node Address</a>	<a href="#">3-3</a>
<a href="#">Setting the I/O Configuration</a>	<a href="#">3-3</a>
<a href="#">Setting Master-Slave Hierarchy</a>	<a href="#">3-4</a>
<a href="#">Setting the Reference Adjustment</a>	<a href="#">3-5</a>
<a href="#">Setting a Fault Action</a>	<a href="#">3-5</a>
<a href="#">Resetting the Adapter</a>	<a href="#">3-7</a>
<a href="#">Viewing the Adapter Status Using Parameters</a>	<a href="#">3-7</a>
<a href="#">Updating the Adapter Firmware</a>	<a href="#">3-8</a>

For a list of parameters, see [Appendix B, Adapter Parameters](#). For definitions of terms in this chapter, see the [Glossary](#).

### Configuration Tools

The adapter stores parameters and other information in its own nonvolatile storage (NVS) memory. You must, therefore, access the adapter to view and edit its parameters. The following tools can be used to access the adapter parameters.

Tool	See
PowerFlex 7-Class HIM	<a href="#">page 3-2</a>
Connected Components Workbench software, version 1.02 or later	<a href="http://www.ab.com/support/abdrives/webupdate/software.html">http://www.ab.com/support/abdrives/webupdate/software.html</a> , or online help (installed with the software)
DriveExplorer software, version 2.01 or later	<a href="http://www.ab.com/drives/driveexplorer">http://www.ab.com/drives/driveexplorer</a> , or online help (installed with the software)
DriveExecutive software, version 3.01 or later	<a href="http://www.ab.com/drives/drivetools">http://www.ab.com/drives/drivetools</a> , or online help (installed with the software)



## Using the PowerFlex 7-Class HIM to Access Parameters

If your drive has either an LED or LCD HIM (Human Interface Module), it can be used to access parameters in the adapter as shown below. We recommend that you read through the steps for your HIM before performing the sequence. For additional information, see the drive documentation or the PowerFlex 7-Class HIM Quick Reference, publication 20HIM-QR001.

### Using an LED HIM

Step	Example Screens
<ol style="list-style-type: none"> <li>1. Press the <b>ALT</b> key and then the Device <b>Sel</b> (Sel) key to display the Device Screen.</li> <li>2. Press the <b>▲</b> or <b>▼</b> key to scroll to the adapter. Letters represent files in the drive, and numbers represent ports. The adapter is usually connected to port 5.</li> <li>3. Press the <b>↵</b> (Enter) key to enter your selection. A parameter database is constructed, and then the first parameter is displayed.</li> <li>4. Edit the parameters using the same techniques that you use to edit drive parameters.</li> </ol>	

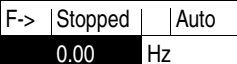
### Using an LCD HIM

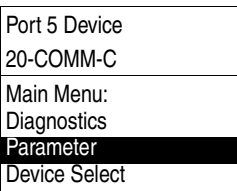
Step	Example Screens
<ol style="list-style-type: none"> <li>1. In the main menu, press the <b>▲</b> or <b>▼</b> key to scroll to <b>Device Select</b>.</li> <li>2. Press the <b>↵</b> (Enter) key to enter your selection.</li> <li>3. Press the <b>▲</b> or <b>▼</b> key to scroll to the adapter (20-COMM-C or 20-COMM-Q).</li> <li>4. Press the <b>↵</b> (Enter) key to select the adapter. A parameter database is constructed, and then the main menu for the adapter is displayed.</li> <li>5. Edit the parameters using the same techniques that you use to edit drive parameters.</li> </ol>	  

**NOTE:** All configuration procedures throughout this chapter use the PowerFlex 7-Class LCD HIM to access parameters in the adapter and show example LCD HIM screens.



**TIP:** When using a PowerFlex 20-HIM-A6 or 20-HIM-C6S HIM, see its User Manual, publication 20-HIM-UM001.

## Setting the Node Address

If the adapter Node Address switches ([Figure 2.1](#)) are set to '00' (Program) the value of **Parameter 03 - [CN Addr Cfg]** determines the node address. When in any other combination of positions, the Node Address switches determine the node address.

1. Set the value of **Parameter 03 - [CN Addr Cfg]** to a unique node address.

Port 5 Device 20-COMM-C	Default = 02
Parameter #: 03 CN Addr Cfg	
<b>2</b>	
0 <> 63	

2. Reset the adapter (see [Resetting the Adapter on page 3-7](#)).

When the node address is correctly configured and the adapter is connected to an operational network, the NET A status indicator should be steady green or flashing green.

## Setting the I/O Configuration

The I/O configuration determines the data that is sent to and from the drive. Logic Command/Status, Reference/Feedback, and Datalinks may be enabled or disabled. (Datalinks allow you to read/write directly to parameters in the drive using implicit I/O.) A '1' enables the I/O and a '0' disables the I/O.

1. Set the bits in **Parameter 13 - [DPI I/O Cfg]**.

Port 5 Device 20-COMM-C	
Parameter #: 13 DPI I/O Cfg	
x x x x x x x x x x 0 0 0 0 <b>1</b>	
Cmd/Ref            b00	

Bit	Description
0	Logic Command/Reference (Default)
1	Datalink A
2	Datalink B
3	Datalink C
4	Datalink D
5...15	Not Used

Bit 0 is the right-most bit. It is highlighted above and equals '1'.

2. If a controller is used to control the drive, set adapter **Parameters 25 - [M-S Input]** and **26 - [M-S Output]** for Master-Slave Hierarchy. For details, see [Setting Master-Slave Hierarchy on page 3-4](#).
3. If Logic Command/Reference is enabled, configure the parameters in the drive to accept the Logic Command and Reference from the adapter. For example, set Parameter 90 - [Speed Ref A Sel] in a PowerFlex 70 or 700 drive to '22' (DPI Port 5) so that the drive uses the Reference from the adapter. Also, verify that the mask parameters (for example, Parameter 276 - [Logic Mask]) in the drive are configured to receive the desired logic from the adapter. See the documentation for your drive for details.

- If you enabled one or more Datalinks, configure parameters in the drive to determine the source and destination of data in the Datalinks.

When using Datalinks, up to 8 drive [Data In xx] parameters (300...307) and/or up to 8 [Data Out xx] parameters (310...317) must be assigned to point to the appropriate drive parameters for your application. See [Chapter 4](#) for an example.

- Reset the adapter (see [Resetting the Adapter on page 3-7](#)).

The adapter is ready to receive I/O. You must now configure the adapter to receive I/O from the master. See [Setting Master-Slave Hierarchy](#).

## Setting Master-Slave Hierarchy

A hierarchy determines the type of device with which the adapter exchanges data. In a Master-Slave hierarchy, the adapter exchanges data with a master, such as a bridge or scanner (1756-CNB/CNBR, 1747-SCNR, and so forth).

- Enable the desired I/O in **Parameter 13 - [DPI I/O Cfg]**.

See [Setting the I/O Configuration on page 3-3](#).

- Set the bits in **Parameter 25 - [M-S Input]**.

This parameter determines the data received from the master by the drive. A '1' enables the I/O and a '0' disables the I/O.

Port 5 Device	
20-COMM-C	
Parameter #: 25	
M-S Input	
x x x x x x x x x x 0 0 0 0 <b>1</b>	
Cmd/Ref	b00

Bit	Description
0	Logic Command/Reference (Default)
1	Datalink A Input
2	Datalink B Input
3	Datalink C Input
4	Datalink D Input
5...15	Not Used

Bit 0 is the right-most bit. It is highlighted above and equals '1'.

- Set the bits in **Parameter 26 - [M-S Output]**.

This parameter determines the data transmitted from the drive to the bridge or scanner. A '1' enables the I/O and a '0' disables the I/O.

Port 5 Device	
20-COMM-C	
Parameter #: 26	
M-S Output	
x x x x x x x x x x 0 0 0 0 <b>1</b>	
Status/Fdbk	b00

Bit	Description
0	Status/Feedback (Default)
1	Datalink A Output
2	Datalink B Output
3	Datalink C Output
4	Datalink D Output
5...15	Not Used

Bit 0 is the right-most bit. It is highlighted above and equals '1'.

- Reset the adapter (see [Resetting the Adapter on page 3-7](#)).



The adapter is ready to receive I/O from the master (that is, scanner). You must now configure the scanner to recognize and transmit I/O to the adapter. See [Chapter 4, Configuring the I/O](#).

## Setting the Reference Adjustment

A Reference Adjustment is a percent scaling factor for the Reference from the network. It can be set between 0.00...200.00% to allow the drive's Reference to either match the network Reference (equal to 100.00%), scale below the network Reference (less than 100.00%), or scale above the network Reference (more than 100.00%).



**ATTENTION:** To guard against equipment damage and/or personal injury, note that changes to adapter **Parameter 27 - [Ref Adjust]** take effect immediately. A drive receiving its Reference from the adapter will receive the newly scaled Reference, resulting in a change of speed.

If the adapter is receiving a Reference, set **Parameter 27 - [Ref Adjust]** to the desired scaling factor.

Port 5 Device	
20-COMM-C	
Parameter #: 27	
Ref Adjust	
100.00	%
0.00 <> 200.00	

Default = 100.00%

The adjustment takes effect as soon as it is entered.

## Setting a Fault Action

By default, when I/O communication is disrupted (for example, a cable is disconnected) or the controller is idle (in program mode or faulted), the drive responds by faulting if it is using I/O from the network. You can configure a different response to these faults:

- Disrupted I/O communication by using **Parameter 10 - [Comm Flt Action]**
- An idle controller by using **Parameter 11 - [Idle Flt Action]**



**ATTENTION:** Risk of injury or equipment damage exists. **Parameters 10 - [Comm Flt Action]** and **11 - [Idle Flt Action]** let you determine the action of the adapter and connected drive if I/O communication is disrupted or the controller is idle. By default, these parameters fault the drive. You can set these parameters so that the drive continues to run, however, precautions should be taken to verify that the settings of these parameters do not create a risk of injury or equipment damage. When commissioning the drive, verify that your system responds correctly to various situations (for example, a disconnected cable or faulted controller).

### Changing the Fault Action

Set the values of **Parameters 10 - [Comm Flt Action]** and **11 - [Idle Flt Action]** to an action that meets your application requirements.

Value	Action	Description
0	Fault	The drive is faulted and stopped. (Default)
1	Stop	The drive is stopped, but not faulted.
2	Zero Data	The drive is sent '0' values for data. This does not command a stop.
3	Hold Last	The drive continues in its present state.
4	Send Flt Cfg	The drive is sent the data that you set in the fault configuration parameters ( <b>Parameters 15 - [Flt Cfg Logic]</b> through <b>24 - [Flt Cfg D2 In]</b> ).

Port 5 Device 20-COMM-C
Parameter #: 10 Comm Flt Action 0
Fault

Port 5 Device 20-COMM-C
Parameter #: 11 Idle Flt Action 0
Fault

Changes to these parameters take effect immediately. A reset is not required.

If communication is disrupted and then is re-established, the drive will automatically receive commands over the network again.

### Setting the Fault Configuration Parameters

When setting **Parameter 10 - [Comm Flt Action]** or **11 - [Idle Flt Action]** to 'Send Flt Cfg', the values in the following parameters are sent to the drive after an I/O communication fault and/or idle fault occurs. You must set these parameters to values required by your application.

Parameter	Description
<b>15 - [Flt Cfg Logic]</b>	A 16-bit value sent to the drive for Logic Command.
<b>16 - [Flt Cfg Ref]</b>	A 32-bit value (0...4294967295) sent to the drive as a Reference or Datalink.
<b>17 - [Flt Cfg x1 In]</b> through <b>24 - [Flt Cfg x2 In]</b>	<b>Important:</b> If the drive uses a 16-bit Reference or 16-bit Datalinks, the most significant word of the value must be set to zero (0) or a fault will occur.

Changes to these parameters take effect immediately. A reset is not required.

## Resetting the Adapter

Changes to switch settings and some adapter parameters require that you reset the adapter before the new settings take effect. You can reset the adapter by power cycling the drive or by using **Parameter 09 - [Reset Module]**.



**ATTENTION:** Risk of injury or equipment damage exists. If the adapter is transmitting control I/O to the drive, the drive may fault when you reset the adapter. Determine how your drive will respond before resetting a connected adapter.

Set **Parameter 09 - [Reset Module]** to '1' (Reset Module).

Port 5 Device 20-COMM-C	<b>Value</b>	<b>Description</b>
Parameter #: 09 Reset Module 1	0	Ready (Default)
Reset Module	1	Reset Module
	2	Set Defaults

When you enter '1' (Reset Module), the adapter will be immediately reset. When you enter '2' (Set Defaults), the adapter will set all adapter parameters to their factory-default values. After performing a Set Defaults, enter '1' (Reset Module) so that the new values take effect. The value of this parameter will be restored to '0' (Ready) after the adapter is reset.

## Viewing the Adapter Status Using Parameters

The following parameters provide information about the status of the adapter. You can view these parameters at any time.

Parameter	Description																											
<b>04 - [CN Addr Act]</b>	The node address used by the adapter. This will be one of the following values: <ul style="list-style-type: none"> <li>The address set by the rotary switches.</li> <li>The value of <b>Parameter 03 - [CN Addr Cfg]</b>.</li> <li>An old address of the switches or parameter if they have been changed and the adapter has not been reset.</li> </ul>																											
<b>06 - [CN Rate Act]</b>	The data rate used by the adapter.																											
<b>07 - [Ref/Fdbk Size]</b>	The size of the Reference/Feedback. It will either be 16 bits or 32 bits. It is set in the drive and the adapter automatically uses the correct size.																											
<b>08 - [Datalink Size]</b>	The size of the Datalinks. It will either be 16 bits or 32 bits. It is set in the drive and the adapter automatically uses the correct size.																											
<b>12 - [CN Active Cfg]</b>	Source from which the adapter node address is taken. This will be either '0' (Switches) or '1' (EEPROM) in which the address from <b>Parameter 03 - [CN Addr Cfg]</b> is stored. The source is determined by the settings of the adapter Node Address switches.																											
<b>14 - [DPI I/O Act]</b>	The Reference/Feedback and Datalinks used by the adapter. This value is the same as <b>Parameter 13 - [DPI I/O Cfg]</b> unless the parameter was changed and the adapter was not reset. <table border="1" data-bbox="803 1732 1169 1864"> <thead> <tr> <th>Bit Definition</th> <th>Not Used</th> <th>Not Used</th> <th>Not Used</th> <th>Datalink D</th> <th>Datalink C</th> <th>Datalink B</th> <th>Datalink A</th> <th>Cmd/Ref</th> </tr> </thead> <tbody> <tr> <td>Default</td> <td>x</td> <td>x</td> <td>x</td> <td>0</td> <td>0</td> <td>0</td> <td>0</td> <td>1</td> </tr> <tr> <td>Bit</td> <td>7</td> <td>6</td> <td>5</td> <td>4</td> <td>3</td> <td>2</td> <td>1</td> <td>0</td> </tr> </tbody> </table>	Bit Definition	Not Used	Not Used	Not Used	Datalink D	Datalink C	Datalink B	Datalink A	Cmd/Ref	Default	x	x	x	0	0	0	0	1	Bit	7	6	5	4	3	2	1	0
Bit Definition	Not Used	Not Used	Not Used	Datalink D	Datalink C	Datalink B	Datalink A	Cmd/Ref																				
Default	x	x	x	0	0	0	0	1																				
Bit	7	6	5	4	3	2	1	0																				

0 = I/O disabled  
1 = I/O enabled

## Updating the Adapter Firmware

The adapter firmware can be updated over the network or serially through a direct connection from a computer to the drive using a 1203-USB or 1203-SSS serial converter.

When updating firmware over the network, you can use the Allen-Bradley ControlFLASH software tool, the built-in update capability of DriveExplorer Lite or Full software, or the built-in update capability of DriveExecutive software.

When updating firmware through a direct serial connection from a computer to a drive, you can use the same Allen-Bradley software tools described above, or you can use HyperTerminal software set to the X-modem protocol.

To obtain a firmware update for this adapter, go to <http://www.ab.com/support/abdrives/webupdate>. This website contains all firmware update files and associated Release Notes that describe the following items:

- Firmware update enhancements and anomalies
- How to determine the existing firmware revision
- How to update firmware using ControlFLASH, DriveExplorer, DriveExecutive, or HyperTerminal software

## Configuring the I/O

This chapter provides instructions on how to configure a Rockwell Automation ControlLogix, PLC-5, or SLC 500 controller to communicate with the adapter and connected PowerFlex drive.

Topic	Page
<a href="#">Using RSLinx Classic Software</a>	4-1
<a href="#">ControlLogix Controller Example</a>	4-2
<a href="#">PLC-5 Controller Example</a>	4-24
<a href="#">SLC 500 Controller Example</a>	4-30

### Using RSLinx Classic Software

RSLinx Classic software, in all its variations (Lite, Gateway, OEM, and so forth), is used to provide a communication link between the computer, network, and controller. RSLinx Classic software requires its network-specific driver to be configured before communication is established with network devices. To configure the RSLinx driver, follow this procedure.

1. Start RSLinx Classic software and select **Communications > Configure Drivers** to display the Configure Drivers screen.
2. From the Available Driver Types pull-down menu, choose the computer communication card (1784-KTCX, 1784-PCC, or 1784-PCIC) being used to connect your computer to the network.
3. Click **Add New...** to display the Add New RSLinx Driver screen.
4. Use the default name or type a new name and click **OK**.  
The 'Configure driver:' screen appears.
5. Configure the driver for your computer and network settings.
6. Click **OK**.

The Configure Drivers screen reappears with the new driver in the Configured Drivers list.

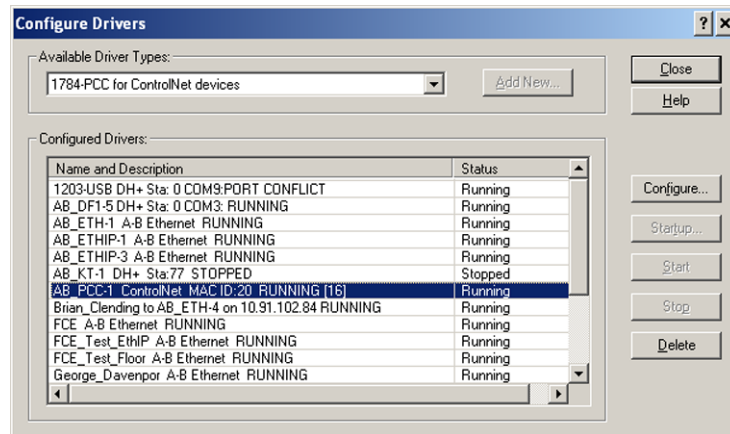

7. Click **Close** to close the Configure Drivers screen.
8. Keep RSLinx running and verify that your computer recognizes the drive.
  - a. Select **Communications > RSWho**.
  - b. In the menu tree, click '+' next to the ControlNet driver.

## ControlLogix Controller Example

After the adapter is configured, the connected drive and adapter will be a single node on the network. This section provides the steps needed to configure a simple ControlNet network (see [Figure 4.1](#)). In our example, we will configure a ControlLogix controller with 1756-CNBR (Series D) bridge to communicate with a drive using Logic Command/Status, Reference/Feedback, and 16 Datalinks (8 to read and 8 to write) over the network.

**Figure 4.1 Example ControlLogix Controller ControlNet Network**

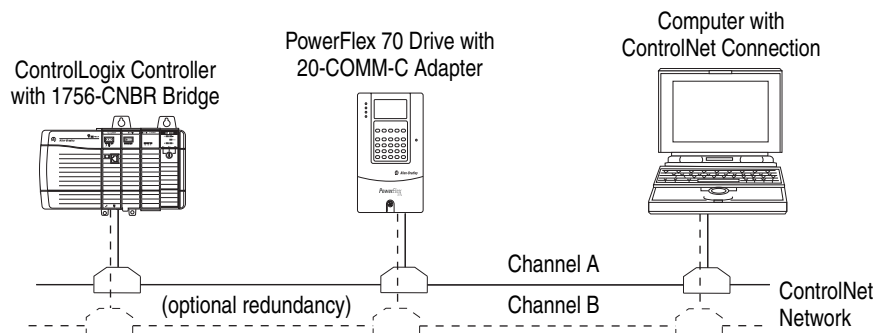

**TIP:** Information for PowerFlex 750-Series drives has been added to this manual where it is applicable.

## Adding the Bridge to the I/O Configuration

To establish communication between the controller and adapter over the network, you must first add the ControlLogix controller and its bridge to the I/O configuration. This procedure is similar for all RSLogix 5000 versions.

1. Start RSLogix 5000 software.
2. Select **File > New** to display the New Controller screen.

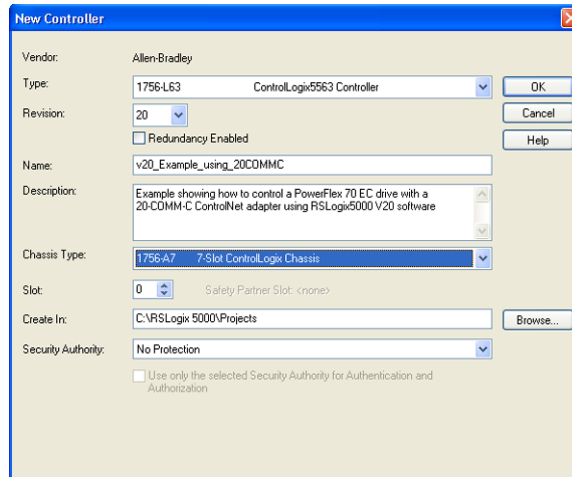

- a. Choose the appropriate choices for the fields in the screen to match your application.
- b. Click **OK**.

The RSLogix 5000 window reappears with the treeview in the left pane.

3. In the treeview, right-click the I/O Configuration folder and choose **New Module**.

The Select Module screen appears.

4. In the list, select the ControlNet bridge used by your controller.

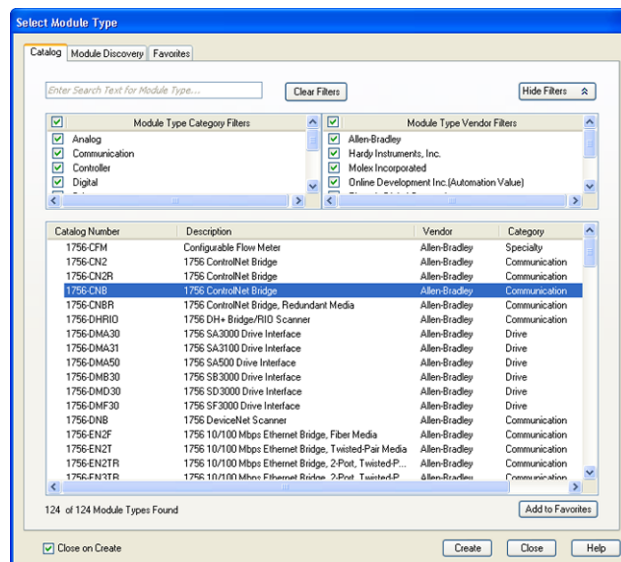

In this example, we use a 1756-CNB ControlNet Bridge (Series E), so the 1756-CNB option is selected.

5. Click **CREATE**.
6. In the Select Major Revision pop-up dialog box, select the major revision of its firmware.
7. Click **OK**.

The bridge's New Module screen appears.

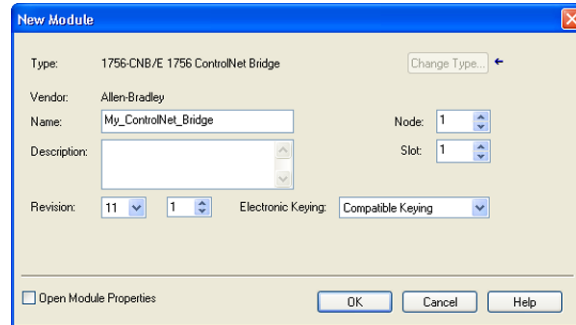

8. Edit the following:

Box	Setting
Name	A name to identify the ControlNet bridge.
Description	Optional – description of the ControlNet bridge.
Node	The node address of the ControlNet bridge.
Slot	The slot of the ControlNet bridge in the rack.
Revision	The minor revision of the firmware in the bridge. (You already set the major revision by selecting the bridge series in step 4.)
Electronic Keying	<b>Compatible Keying.</b> The 'Compatible Keying' setting for Electronic Keying ensures the physical module is consistent with the software configuration before the controller and bridge make a connection. Therefore, be sure that you have set the correct revision in this screen. See the online Help for additional information on this and other Electronic Keying settings.
Open Module Properties	When this box is checked, clicking <b>OK</b> opens additional module properties screens to further configure the bridge. When unchecked, clicking <b>OK</b> closes the bridge's New Module screen. For this example, uncheck this box.

9. Click **OK**.

The bridge is now configured for the ControlNet network and added to the RSLogix 5000 project. It appears in the I/O Configuration folder. In our example, a 1756-CNB/E bridge appears under the I/O Configuration folder with its assigned name.

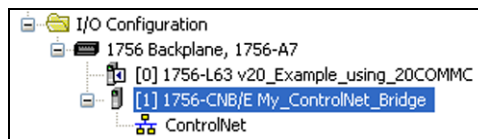

For convenience, keep the project open. Later in this chapter the project will need to be downloaded to the controller.



There are three ways to add the adapter into the I/O configuration:

- Drive Add-on Profiles (RSLogix 5000 software, version 16.00 or later)
- Classic Profile (RSLogix 5000 software, versions 13.00...15.00)
- Generic Profile (RSLogix 5000 software, all versions)

These are described in separate sections below. If your version of RSLogix 5000 software supports drive Add-on Profiles, we recommend that you use this method.

### Using RSLogix 5000 Drive Add-on Profiles, Version 16.00 or Later

When compared to using the RSLogix 5000 Classic Profile (versions 13.00...15.00) or Generic Profile (all versions), the RSLogix 5000 drive Add-on Profiles provide the following advantages:

- Profiles for specific drives that provide descriptive controller tags for basic control I/O words (Logic Command/Status and Reference/Feedback) **and** Datalinks. Additionally, Datalinks automatically take the name of the drive parameter to which they are assigned. These profiles virtually eliminate I/O mismatch errors and substantially reduce drive configuration time.
- New Drive tab eliminates the need for a separate drive software configuration tool.
- Drive configuration settings are saved as part of the RSLogix 5000 software, version 16.00 or later, project file (.ACD) and also downloaded to the controller.
- Drive Add-on Profiles can be updated anytime. When a new drive is used, or to benefit from new updates for Add-on Profiles, you will need the newest Add-on Profile update. Go to <http://www.ab.com/support/abdrives/webupdate> to download the latest RSLogix 5000 drive Add-on Profile. To determine your drive Add-on Profile version, see Allen-Bradley Knowledgebase document #65882.

#### Add the Drive/Adapter to the I/O Configuration

To transmit data between the bridge and the drive, you must add the drive as a child device to the parent bridge. In this example, RSLogix 5000 software, version 20.00 is used with drive Add-on Profile version 4.04.

1. In the treeview, right-click on the bridge and choose **New Module...** to display the Select Module screen.

In our example, we right-click on the 1756-CN/B/E bridge.

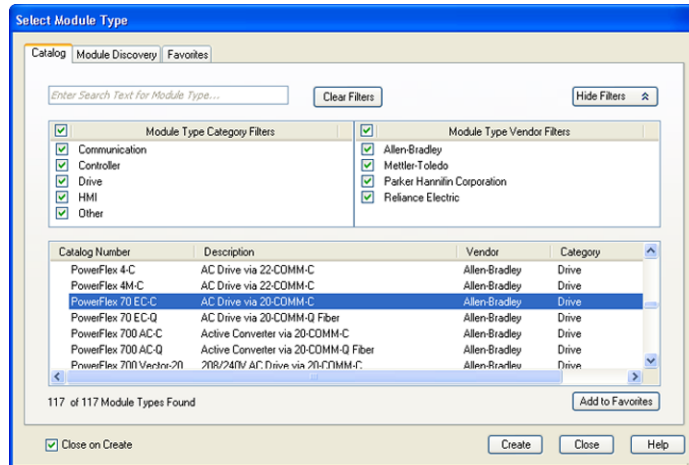

▶ **TIP:** If the PowerFlex drive is not shown, go to <http://www.ab.com/support/abdrives/webupdate> and download the latest RSLogix 5000 drive Add-on Profile.

2. From the list, select the drive and its connected adapter.  
For this example, we selected 'PowerFlex 70 EC-C'.
3. Click **CREATE**.

The drive's New Module screen appears.

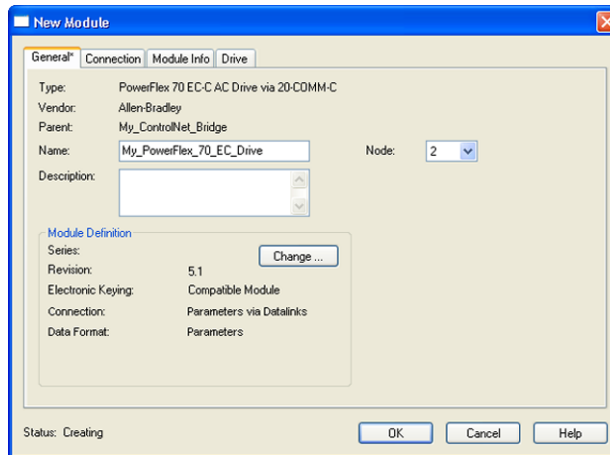

4. On the General tab, edit the following data about the drive/adapter.

Box	Setting
Name	A name to identify the drive.
Description	Optional – description of the drive/adapter.
Node	The node address of the adapter.

5. On the New Module screen in the Module Definition section, click **Change...** to launch the Module Definition screen and begin the drive/adapter configuration process.

In this example, Datalinks are used to do the following.

Read...	Write to...
Output Current (Parameter 3)	Accel Time 1 (Parameter 140)
DC Bus Voltage (Parameter 12)	Decel Time 1 (Parameter 142)
Fault 1 Code (Parameter 243)	High Resolution Reference (Parameter 308)

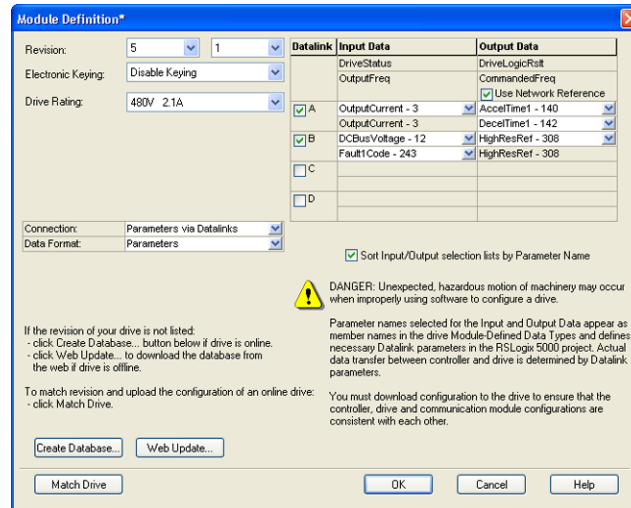

► **TIP:** To get the latest RSLogix 5000 drive Add-on Profile, go to <http://www.ab.com/support/abdrives/webupdate>.

6. In the Module Definition screen, edit the following information.

Box	Setting
Revision	<p>The major and minor revision of the firmware (database) in the drive. If the drive's major and minor revision is not available, the drive database is not installed on your computer. To get the correct database revision, use one of the following buttons at the bottom left of the Module Definition screen:</p> <ul style="list-style-type: none"> <li>• <b>Create Database:</b> Creates a database from an online network drive. Clicking this button displays an RSLinx software RSWho window. Browse to the online drive (for this example, PowerFlex 70 EC), select it, and click <b>OK</b>. The database will be uploaded and stored on the computer. Thereafter, close the Module Definition screen and then re-open it to display the new revision.</li> <li>• <b>Web Update:</b> When a drive is not available online, opens the Allen-Bradley Drives Web Updates website to download a specific database file. After downloading the file, close the Module Definition screen and then re-open it to display the new revision.</li> <li>• <b>Match Drive:</b> Use this button when the drive being added to the network matches the drive profile (revision, rating, configuration settings, and so forth) of an existing online network drive. Click this button to conveniently create a duplicate drive profile from the online drive, and automatically load this identical information into the Module Definition screen. This eliminates the need to manually enter the information each time a new drive with a matching profile is added to the network.</li> </ul>
Electronic Keying	<p><b>Compatible Module.</b> The 'Compatible Module' setting for Electronic Keying ensures that the physical module is consistent with the software configuration before the controller and bridge make a connection. Therefore, ensure that you have set the correct revision in this screen. See the online Help for additional information on this and other Electronic Keying settings. If keying is not required, select 'Disable Keying'. Drives do not require keying, and so 'Disable Keying' is recommended.</p>

Box	Setting
Drive Rating	The voltage and current rating of the drive. If the drive rating is not listed, the drive database is not installed on your computer. To get the correct drive rating, use the <b>Create Database</b> , <b>Web Update</b> , or <b>Match Drive</b> button described above.
Connection	<b>Parameters via Datalinks.</b> When selecting 'Parameters via Datalinks' (default), the controller tags for the Datalinks use the drive parameter names to which they are assigned. When selecting 'Datalinks', the controller tags for the Datalinks have non-descriptive UserDefinedData[n] names like those used in RSLogix 5000 software, version 15.00.
Data Format	<b>Parameters.</b> When the Connection field is set to 'Parameters via Datalinks', 'Parameters' is automatically selected. When the Connection field is set to 'Datalinks', you must select the number of Datalinks required for your application in the 'Data Format' field.
Datalink A, B, C, D	In the Input Data column, assigns selected drive parameters to be READ by the controller. In the Output Data column, assigns selected drive parameters to be WRITTEN by the controller.
Sort Input/ Output selection...	When this box is checked, sorts the Input Data and Output Data assigned parameters by name and then by number, and enables parameter search by name. When unchecked, sorts the assigned parameters by parameter number and then by name, and enables parameter search by number.
Use Network Reference	Conveniently selects the speed reference for the drive to come from the network. This box is checked by default.

When a 32-bit parameter is selected for Input Data or Output Data for a drive with 16-bit Datalinks, two contiguous Datalinks (for example, x1 and x2, where x = A, B, C or D) are automatically assigned as a pair to represent that parameter. See Datalink examples in the screen shown on the previous page. For more information on Datalinks, see [Using Datalinks on page 5-11](#).

On the Module Definition screen, notice that the automatically-assigned controller tags DriveStatus, OutputFreq, DriveLogicRslt, and CommandedFreq are always used.

When a Datalink is enabled, the following 20-COMM-C or 20-COMM-Q adapter I/O parameters are automatically set:

- **Parameter 13 - [DPI I/O Cfg]** turns on the enabled Datalink bit so the 20-COMM-C or 20-COMM-Q adapter will communicate that Datalink's information with the drive.
- **Parameter 25 - [M-S Input]** turns on the enabled Datalink bit so the 20-COMM-C or 20-COMM-Q adapter will input that Datalink's information from the controller.
- **Parameter 26 - [M-S Output]** turns on the enabled Datalink bit so the 20-COMM-C or 20-COMM-Q adapter will output that Datalink's information to the controller.

7. Click **OK** on the Module Definition screen to save the drive and adapter configuration and close the screen.

The drive's New Module screen reappears.

8. On the New Module screen, click the Connection tab.

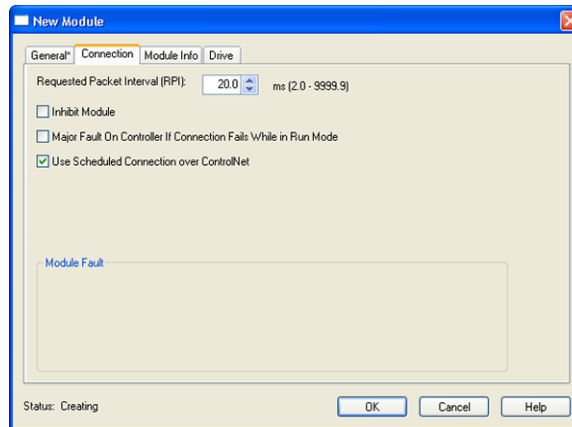

9. In the 'Requested Packet Interval (RPI)' box, set the value to 5.0 milliseconds or greater.

This value determines the maximum interval that a controller should use to move data to and from the adapter. To conserve bandwidth, use higher values for communicating with low priority devices. We recommend keeping the default value of 20.0 milliseconds.

The 'Inhibit Module' box, when checked, inhibits the module from communicating with the RSLogix 5000 project. When the 'Major Fault on...' box is checked, a major controller fault will occur when the module's connection fails while the controller is in the Run Mode. For this example, leave the 'Inhibit Module' and 'Major Fault On...' boxes unchecked, but keep the 'Use Scheduled Connections over ControlNet' box checked.

10. On the New Module screen, click the Drive tab.

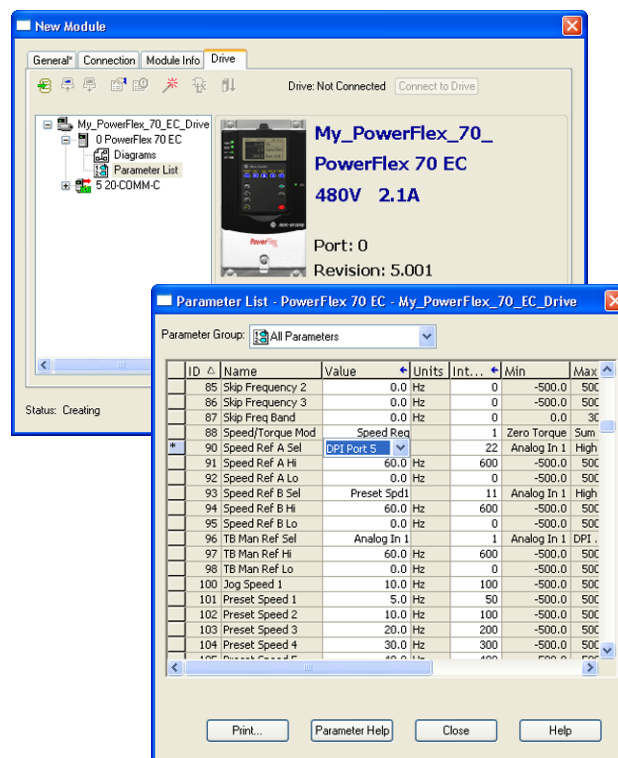

11. In the treeview, double-click Parameter List to display the drive’s linear parameter list.

- a. Scroll to drive parameter 90 - [Speed Ref A Sel] and set its value to ‘DPI Port 5’.

This enables the drive to receive its Reference from the network via the 20-COMM-C or 20-COMM-Q adapter. For speed Reference scaling information, see [Using Reference/Feedback on page 5-8](#).

- b. Click **Close** to save the setting and close the Parameters List screen.

The New Module screen reappears.

12. Click **OK** on the New Module screen.

The new node (‘My\_PowerFlex\_70\_EC\_Drive’ in this example) now appears under the bridge (‘My\_ControlNet\_Bridge’ in this example) in the I/O Configuration folder. If you double-click the Controller Tags, you will see that module-defined data types and tags have been automatically created ([Figure 4.2](#)). Note that all tag names are defined and Datalinks include the assigned drive parameter name. After you save and download the configuration, these tags allow you to access the Input and Output data of the drive via the controller’s ladder logic.

**Figure 4.2 Controller Tags**

Name	Value	Force Mask	Style	Data Type
[-] My_PowerFlex_70_EC_Drive:I	{...}	{...}		AB:PowerFlex70E...
+ My_PowerFlex_70_EC_Drive:I.DriveStatus	2#0000...		Binary	INT
- My_PowerFlex_70_EC_Drive:I.DriveStatus_Ready	0		Decimal	BOOL
- My_PowerFlex_70_EC_Drive:I.DriveStatus_Active	0		Decimal	BOOL
- My_PowerFlex_70_EC_Drive:I.DriveStatus_CommandDir	0		Decimal	BOOL
- My_PowerFlex_70_EC_Drive:I.DriveStatus_ActualDir	0		Decimal	BOOL
- My_PowerFlex_70_EC_Drive:I.DriveStatus_Accelerating	0		Decimal	BOOL
- My_PowerFlex_70_EC_Drive:I.DriveStatus_Decelerating	0		Decimal	BOOL
- My_PowerFlex_70_EC_Drive:I.DriveStatus_Alarm	0		Decimal	BOOL
- My_PowerFlex_70_EC_Drive:I.DriveStatus_Faulted	0		Decimal	BOOL
- My_PowerFlex_70_EC_Drive:I.DriveStatus_AtSpeed	0		Decimal	BOOL
- My_PowerFlex_70_EC_Drive:I.DriveStatus_LocalD0	0		Decimal	BOOL
- My_PowerFlex_70_EC_Drive:I.DriveStatus_LocalD1	0		Decimal	BOOL
- My_PowerFlex_70_EC_Drive:I.DriveStatus_LocalD2	0		Decimal	BOOL
- My_PowerFlex_70_EC_Drive:I.DriveStatus_SpdRefID0	0		Decimal	BOOL
- My_PowerFlex_70_EC_Drive:I.DriveStatus_SpdRefID1	0		Decimal	BOOL
- My_PowerFlex_70_EC_Drive:I.DriveStatus_SpdRefID2	0		Decimal	BOOL
- My_PowerFlex_70_EC_Drive:I.DriveStatus_SpdRefID3	0		Decimal	BOOL
+ My_PowerFlex_70_EC_Drive:I.OutputFreq	0		Decimal	INT
+ My_PowerFlex_70_EC_Drive:I.OutputCurrent	0		Decimal	DINT
+ My_PowerFlex_70_EC_Drive:I.DCBusVoltage	0		Decimal	INT
+ My_PowerFlex_70_EC_Drive:I.FaultCode			Decimal	INT
[-] My_PowerFlex_70_EC_Drive:O	{...}	{...}		AB:PowerFlex70E...
+ My_PowerFlex_70_EC_Drive:O.DriveLogicRslt	2#0000...		Binary	INT
- My_PowerFlex_70_EC_Drive:O.DriveLogicRslt_Stop	0		Decimal	BOOL
- My_PowerFlex_70_EC_Drive:O.DriveLogicRslt_Start	0		Decimal	BOOL
- My_PowerFlex_70_EC_Drive:O.DriveLogicRslt_Jog	0		Decimal	BOOL
- My_PowerFlex_70_EC_Drive:O.DriveLogicRslt_ClearFault	0		Decimal	BOOL
- My_PowerFlex_70_EC_Drive:O.DriveLogicRslt_Forward	0		Decimal	BOOL
- My_PowerFlex_70_EC_Drive:O.DriveLogicRslt_Reverse	0		Decimal	BOOL
- My_PowerFlex_70_EC_Drive:O.DriveLogicRslt_LocalContrl	0		Decimal	BOOL
- My_PowerFlex_70_EC_Drive:O.DriveLogicRslt_MOPlnc	0		Decimal	BOOL
- My_PowerFlex_70_EC_Drive:O.DriveLogicRslt_Accel1	0		Decimal	BOOL
- My_PowerFlex_70_EC_Drive:O.DriveLogicRslt_Accel2	0		Decimal	BOOL
- My_PowerFlex_70_EC_Drive:O.DriveLogicRslt_Decel1	0		Decimal	BOOL
- My_PowerFlex_70_EC_Drive:O.DriveLogicRslt_Decel2	0		Decimal	BOOL
- My_PowerFlex_70_EC_Drive:O.DriveLogicRslt_SpdRefID0	0		Decimal	BOOL
- My_PowerFlex_70_EC_Drive:O.DriveLogicRslt_SpdRefID1	0		Decimal	BOOL

## Save the I/O Configuration to the Controller

After adding the bridge and drive/adaptor to the I/O configuration, you must download the configuration to the controller. You should also save the configuration to a file on your computer.

1. In the RSLogix 5000 window, select **Communications > Download**.

The Download dialog box appears.

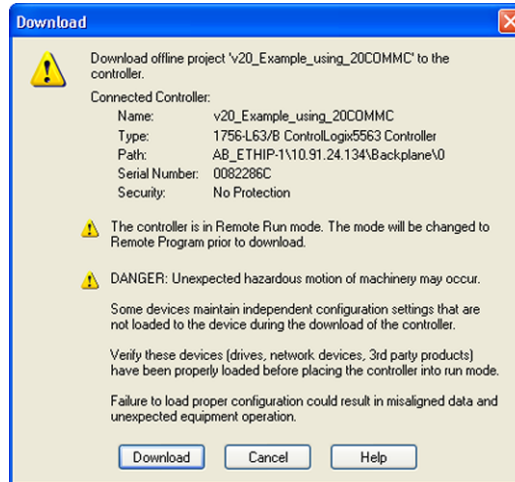

- **TIP:** If a message box reports that RSLogix 5000 software is unable to go online, select **Communications > Who Active** to find your controller in the Who Active screen. After finding and selecting the controller, click **Set Project Path** to establish the path. If your controller does not appear, you need to add or configure the ControlNet driver with RSLinx software. See [Using RSLinx Classic Software on page 4-1](#) and RSLinx online help for details.

2. Click **Download** to download the configuration to the controller.

When the download is successfully completed, RSLogix 5000 software goes into the Online mode and the I/O Not Responding box in the upper-left of the window should be flashing green. Also, a yellow warning symbol ⚠ should be displayed on the I/O Configuration folder in the treeview and on the drive profile because the connections have not yet been scheduled using RSNetWorx for ControlNet software.

If the controller was in Run Mode before clicking **Download**, RSLogix 5000 software prompts you to change the controller mode back to Remote Run. In this case, choose the appropriate mode for your application. If the controller was in Program Mode before clicking **Download**, this prompt will not appear.

3. Select **File > Save**.

If this is the first time you saved the project, the Save As dialog box appears.

- a. Navigate to a folder
- b. Type a file name.

- c. Click **Save** to save the configuration to a file on your computer.

To be sure that the present project configuration values are saved, RSLogix 5000 software prompts you to upload them. Click **Yes** to upload and save the values.

### Correlate the Drive with the Controller

You must now correlate the drive settings to the RSLogix 5000 project I/O settings so that they match. This requires loading the project I/O settings into the drive.

1. In the treeview under I/O Configuration, right-click the drive profile (for this example, My\_PowerFlex\_70\_EC\_Drive) and choose **Properties**.
2. Click the Drive tab.

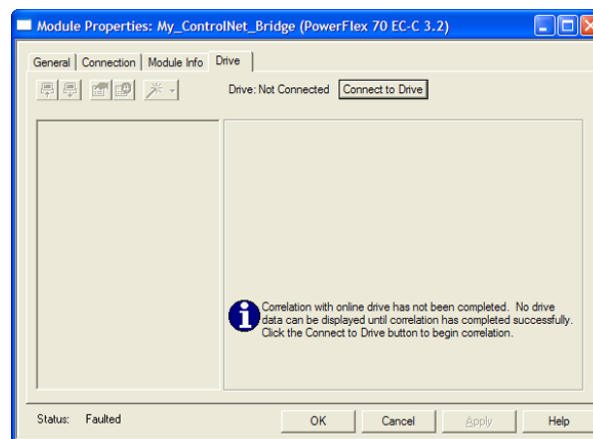

3. Click **Connect to Drive** to begin the correlation process.

The Connect To Drive screen appears.

4. Browse the communication path to the drive and select the drive.
5. Click **OK**.

After the drive configuration data has been verified, a pop-up dialog box appears, which synchronizes ports from the online drive to the project to be sure that correct Datalinks are assigned.

6. Click **OK**.

If the Differences Found screen appears—which is typical, click **Download**. This will download the project settings from the controller to the drive and its connected adapter. If **Upload** is clicked, the drive and adapter settings are uploaded to the controller.

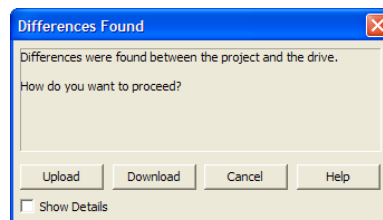



► **TIP:** On subsequent connections to the drive (after initial download), click **Upload**.

7. When the Reset Comm Module screen appears, click **Yes** to reset the communication adapter so that the new I/O settings take effect.

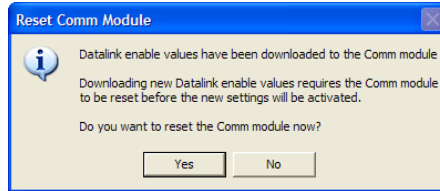

After resetting the communication module, which may take up to a minute to complete, a Comm Module Reset Error popup message may appear. If it does, click **OK** to close this message and complete the adapter reset. Then click **OK** to close the Drive Correlation screen.

8. Use the procedure in the next subsection [Use RSNetworx for ControlNet Software to Save the I/O to the Bridge](#) to do the following:
  - Change the I/O Not Responding box in the upper-left of the RSLogix 5000 window from flashing green to steady green.
  - Remove the yellow warning symbols in the treeview under the I/O Configuration folder and drive profile.

#### Use RSNetworx for ControlNet Software to Save the I/O to the Bridge

After configuring the I/O in the controller and drive, you must now download and save these configurations to the bridge. This will also resolve the I/O Not Responding box and the yellow warning symbols ⚠ in the RSLogix 5000 project.

1. Start RSNetWorx for ControlNet software.
2. In the RSNetWorx for ControlNet window, select **File > New** to display the New File screen.
3. Select 'ControlNet Configuration' as the network configuration type.
4. Click **OK**.

5. Select **Network > Online** to display the Browse for Network screen.

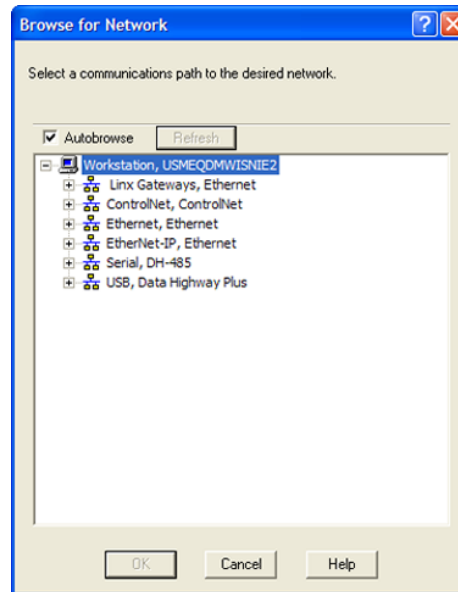

6. Expand the communication path from your computer to the ControlNet bridge.

The following screen shows our example navigating to devices that are on a ControlNet network. Depending on the communication link you are using, the navigation path may be different.

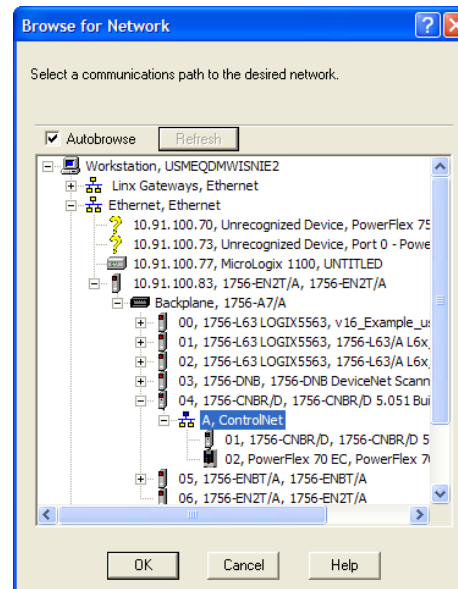

7. After selecting a valid path to the ControlNet network (for this example, A, ControlNet), click **OK**.

As the selected ControlNet path is browsed, RSNetWorx for ControlNet software creates a graph view window that shows a graphical representation of the devices on the network.

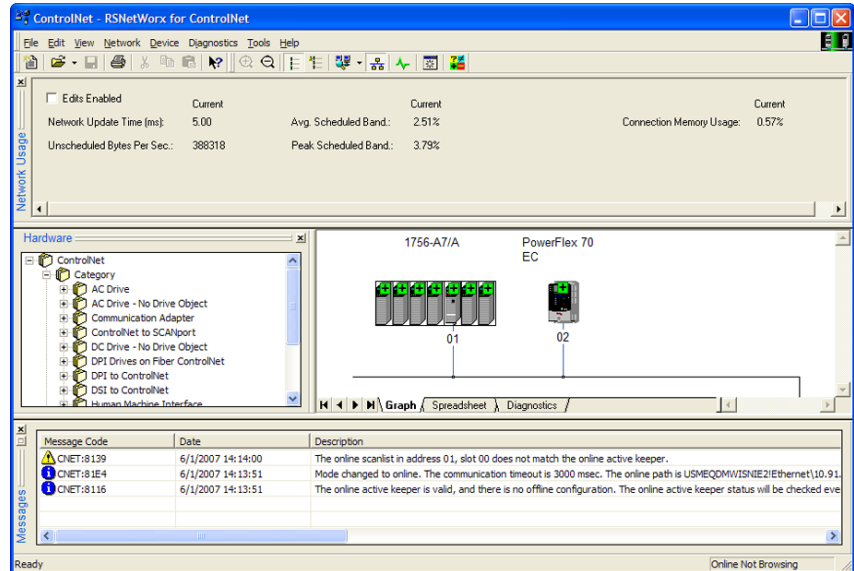

If the icon for the drive (for this example, PowerFlex 70 EC) on the network appears as Unrecognized Device, you must download the EDS file for that PowerFlex drive from the Rockwell Automation website.

- a. Go to the website <http://www.rockwellautomation.com/resources/eds>.
- b. On the website search screen in the Network entry field, enter the type of network (for this example, ControlNet), which enables the use of the other search fields.
- c. In the Keyword entry field, enter the type of PowerFlex drive (for this example, PowerFlex 70EC), noting that this field is space sensitive.
- d. Click **Search**.

Due to the large number of EDS files, this search may take seconds or up to several minutes.

- e. On the search results screen in the Details & Download Column, click the 'Download' hyperlink for the EDS file.
- f. Click **Save** on the File Download screen to save the EDS file to an appropriate location on your computer.
- g. Launch the EDS Hardware Installation Tool by clicking the Microsoft Windows Start button and selecting **Programs > Rockwell Software > RSLinx Tools > EDS Hardware Installation Tool**.

Follow the screen prompts to add the EDS file for use with your project.

- h. Reboot the computer and repeat steps 1 through 7 at the beginning of this subsection.

The Unrecognized Device icon in the RSNetWorx for ControlNet graph view window in step 7 should have been replaced by a drive icon (for this example, the icon for a PowerFlex 70 EC drive).

8. Select **Network > Enable Edits** or check the Edits Enabled box in the RSNetWorx for ControlNet project window.

If the bridge has a different I/O configuration than the configuration now being saved, the Online/Offline mismatch dialog box will appear.

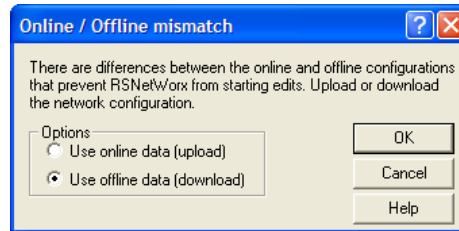

- a. When both Options choices are available, click ‘Use offline data (download)’. When this choice is dimmed (grayed out), you must click ‘Use online data (upload)’.
- b. Click **OK**.

▶ **TIP:** If a message box reports that the download cannot be completed because the controller is not in Program mode, click **Change Mode** to place the controller in Remote Program mode and continue the download.

9. Select **File > Save** to save the I/O configuration file to the computer.

If this is the first time you saved the project, the Save As dialog box appears.

- a. Navigate to a folder.
- b. Type a file name.
- c. Click **Save** to save the configuration as a file on your computer.

The Save Configuration dialog box appears.

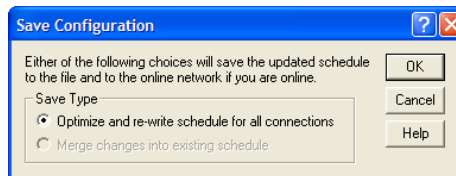

▶ **TIP:** When both Save Type choices are available, we recommend you click ‘Optimize and re-write schedule for all connections’.

- d. Click **OK** to download the I/O configuration to the bridge.

## Using the RSLogix 5000 Classic Profile, Versions 13.00...15.00

When compared to using the RSLogix 5000 Generic Profile (all versions), the RSLogix 5000 Classic Profile provides these advantages:

- Profiles for specific drives ([Figure 4.3](#)) that provide descriptive controller tags for basic control I/O words (Logic Command/Status and Reference/Feedback). The controller tags for Datalinks, however, have non-descriptive UserDefinedData[n] names.
- Improved I/O configuration—no I/O assembly configuration required. Basic control I/O is defined, but Datalinks still need to be configured/mapped.
- The Setup tab includes a DriveExecutive icon link to conveniently launch DriveExecutive software (when installed on computer) to match the adapter I/O configuration with the controller, and to assign the Datalink parameters in the drive. This reduces I/O mismatches.



**TIP:** Because the RSLogix 5000 Classic Profile has been significantly improved upon by RSLogix 5000 Drive Add-on Profiles, version 16.00 or later, we recommend using RSLogix 5000 Drive Add-on Profiles to take advantage of their benefits (more intuitive, time saving, and less likely to make I/O configuration errors).

**Figure 4.3 Classic Profile Screens for Drives**

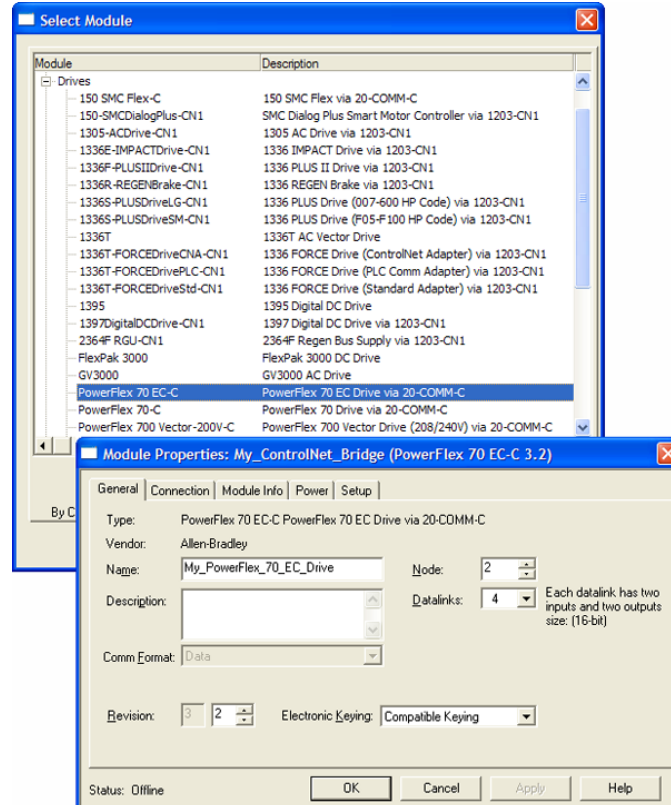

When Datalinks are used, you must enable the desired Datalinks and assign names to their non-descriptive controller tags. When a Datalink is enabled, you must set the following adapter I/O parameters:

- **Parameter 13 - [DPI I/O Cfg]** turns on the enabled Datalink bit so the 20-COMM-C or 20-COMM-Q adapter will communicate that Datalink's information with the drive.
- **Parameter 25 - [M-S Input]** turns on the enabled Datalink bit so the 20-COMM-C or 20-COMM-Q adapter will input that Datalink's information from the controller.
- **Parameter 26 - [M-S Output]** turns on the enabled Datalink bit so the 20-COMM-C or 20-COMM-Q adapter will output that Datalink's information to the controller.

When using Datalinks, up to 8 drive [Data In xx] parameters (300...307) and/or up to 8 [Data Out xx] parameters (310...317) must be assigned to point to the appropriate drive parameters for your application.

**Important:** To change the I/O Not Responding box in the upper-left of the RSLogix 5000 window from flashing green to steady green, and to remove the yellow warning symbols  displayed in the treeview under the I/O Configuration folder and drive profile, follow the procedure in [Use RSNetwork for ControlNet Software to Save the I/O to the Bridge on page 4-13](#).

### Using the RSLogix 5000 Generic Profile, All Versions

We recommend that you use the basic RSLogix 5000 Generic Profile for **only the following reasons:**

- A specific drive profile in other versions of RSLogix 5000 software is unavailable.
- Users are already familiar with a drive Generic Profile and do not want to convert an existing project to a Classic Profile, versions 13.00...15.00, or to a drive Add-on Profile (RSLogix 5000 software, version 16.00 or later.)
- A project must maintain specific revision level control.
- The controller cannot be taken offline. RSLogix 5000 software, version 16.00 or later, enables the drive Generic Profile to be added while the controller is online and in the Run mode.

### Add the Drive/Adapter to the I/O Configuration

To transmit data between the bridge and the drive, you must add the drive as a child device to the parent bridge.

1. In the treeview, right-click the bridge and select **New Module...** to display the Select Module screen.

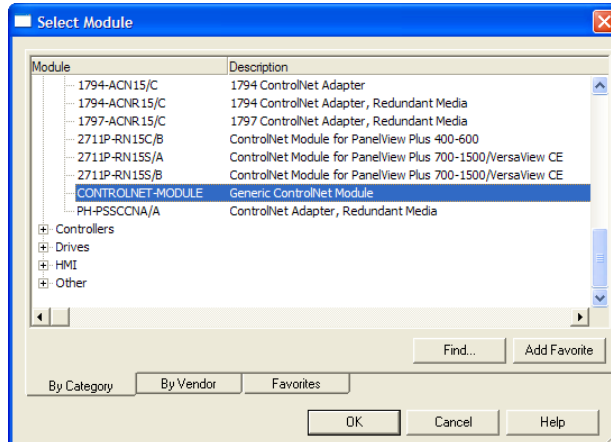

In our example, we right-click on the 1756-CNBR/D bridge.

2. Expand the Communications group to display all of the available communication modules.
3. Select 'CONTROLNET-MODULE' from the list to configure the drive and its connected 20-COMM-C or 20-COMM-Q adapter.
4. Click **OK**.

The drive's New Module screen appears.

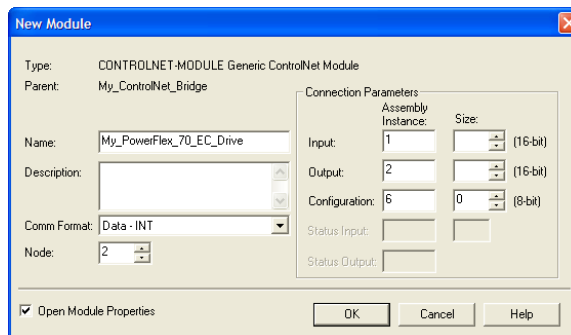

5. Edit the following information about the drive and adapter.

Box	Setting
Name	A name to identify the drive and adapter.
Description	Optional – description of the drive/adapter.
Comm Format	<b>Data - INT</b> (This setting formats the data in 16-bit words.)
Node	The node address of the adapter.
Open Module Properties	When this box is checked, clicking <b>OK</b> opens additional module properties screens to further configure the drive/adapter. When unchecked, clicking <b>OK</b> closes the drive's New Module screen. For this example, check this box.

6. Under Connection Parameters, edit the following information.

Box	Assembly Instance	Size
Input	1 (This value is required.)	The value will vary based on your application (setting of <b>Parameters 13 - [DPI I/O Cfg]</b> and <b>26 - [M-S Output]</b> ) and the size (16-bit or 32-bit) of the Reference/Feedback and Datalinks in the drive. See <a href="#">Table 4.A</a> , <a href="#">Table 4.B</a> or <a href="#">Table 4.C</a> .
Output	2 (This value is required.)	The value will vary based on your application (setting of <b>Parameters 13 - [DPI I/O Cfg]</b> and <b>25 - [M-S Input]</b> ) and the size (16-bit or 32-bit) of the Reference/Feedback and Datalinks in the drive. See <a href="#">Table 4.A</a> , <a href="#">Table 4.B</a> or <a href="#">Table 4.C</a> .
Configuration	6 (This value is required.)	0 (This value is required.)

Depending on the size of the drive’s Reference/Feedback and the number of Datalinks used in your I/O configuration, [Table 4.A](#), [Table 4.B](#), or [Table 4.C](#) defines the number of 16-bit words that you need to enter for the Input Size and Output Size boxes.

**Table 4.A Drives with 16-bit Reference/Feedback and 16-bit Datalinks**

These products include the following:

- PowerFlex 70 drives with standard or enhanced control
- PowerFlex 700 drives with standard control
- PowerFlex 700H drives
- SMC Flex smart motor controllers
- SMC-50 smart motor controllers

Logic Command/ Status	Ref/Fdbk (16-bit)	Datalinks (16-bit)				User Configured Settings				
		A	B	C	D	Size in Words		Par. 13 - [DPI I/O Cfg]	Par. 25 - [M-S Input]	Par. 26 - [M-S Output]
						Input	Output			
✓	✓					4	2	...0 0001	...0 0001	...0 0001
✓	✓	✓				6	4	...0 0011	...0 0011	...0 0011
✓	✓	✓	✓			8	6	...0 0111	...0 0111	...0 0111
✓	✓	✓	✓	✓		10	8	...0 1111	...0 1111	...0 1111
✓	✓	✓	✓	✓	✓	12	10	...1 1111	...1 1111	...1 1111

**Table 4.B Drives with 16-bit Reference/Feedback and 32-bit Datalinks**

These products include the following:

- PowerFlex 700 drives with vector control
- PowerFlex 700L drives with 700 control
- PowerFlex Digital DC drives

Logic Command/ Status	Ref/Fdbk (16-bit)	Datalinks (32-bit)				User Configured Settings				
		A	B	C	D	Size in Words		Par. 13 - [DPI I/O Cfg]	Par. 25 - [M-S Input]	Par. 26 - [M-S Output]
						Input	Output			
✓	✓					4	2	...0 0001	...0 0001	...0 0001
✓	✓	✓				8	6	...0 0011	...0 0011	...0 0011
✓	✓	✓	✓			12	10	...0 0111	...0 0111	...0 0111
✓	✓	✓	✓	✓		16	14	...0 1111	...0 1111	...0 1111
✓	✓	✓	✓	✓	✓	20	18	...1 1111	...1 1111	...1 1111



**Table 4.C Drives with 32-bit Reference/Feedback and 32-bit Datalinks**

These products include the following:

- PowerFlex 700S drives with Phase I or Phase II control
- PowerFlex 753 drives
- PowerFlex 700L drives with 700S control
- PowerFlex 755 drives

Logic Command/Status	Ref/Fdbk (32-bit)	Datalinks (32-bit)				User Configured Settings				
		A	B	C	D	Size in Words		Par. 13 - [DPI I/O Cfg]	Par. 25 - [M-S Input]	Par. 26 - [M-S Output]
						Input	Output			
✓	✓					6	4	...0 0001	...0 0001	...0 0001
✓	✓	✓				10	8	...0 0011	...0 0011	...0 0011
✓	✓	✓	✓			14	12	...0 0111	...0 0111	...0 0111
✓	✓	✓	✓	✓		18	16	...0 1111	...0 1111	...0 1111
✓	✓	✓	✓	✓	✓	22	20	...1 1111	...1 1111	...1 1111

► **TIP:** For instructions on configuring the I/O for the adapter using **Parameter 13 - [DPI I/O Cfg]** and its Master-Slave hierarchy using **Parameters 25 - [M-S Input]** and **26 - [M-S Output]**, see [Setting the I/O Configuration on page 3-3](#).

When using Datalinks, up to 8 drive [Data In xx] parameters (300...307) and/or up to 8 [Data Out xx] parameters (310...317) must be assigned to point to the appropriate drive parameters for your application.

7. After setting the information in the drive’s New Module screen, click **OK**.

The Module Properties screen appears.

8. Click the Connection tab.

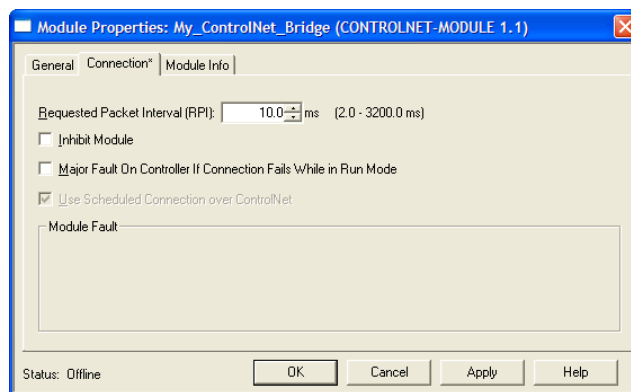

9. In the ‘Requested Packet Interval (RPI)’ box, set the value to 5.0 milliseconds or greater.

This value determines the maximum interval that a controller should use to move data to and from the adapter. To conserve bandwidth, use higher values for communicating with low priority devices. For this example, leave the ‘Inhibit Module’ and ‘Major Fault...’ boxes unchecked.

10. Click **OK**.

The new node ('My\_PowerFlex\_70\_EC\_Drive' in this example) now appears under the bridge ('My\_ControlNet\_Bridge' in this example) in the I/O Configuration folder. If you double-click the Controller Tags, you will see that module-defined data types and tags have been automatically created (Figure 4.4). After you save and download the configuration, these tags allow you to access the Input and Output data of the drive via the controller's ladder logic.

For this example, all Datalinks (A, B, C, and D) are enabled. The Input Size is set to 12 words and the Output Size is set to 10 words. Also, the following adapter I/O parameters are set to the following values.

Adapter Parameter No.	Setting
13 - [DPI I/O Cfg]	XXXX XXXX XXX1 1111
25 - [M-S Input]	XXXX XXXX XXX1 1111
26 - [M-S Output]	XXXX XXXX XXX1 1111

- Reset the adapter (see [Resetting the Adapter on page 3-7](#)) or power cycle the drive.

For the drive speed reference and Datalink parameter values and the adapter setup parameter values, see [Drive and Adapter Parameter Settings on page 5-24](#).

Figure 4.4 Controller Tags

Name	Value	Force Mask	Style	Data Type
My_PowerFlex_70_EC_Drive:C	{...}	{...}		AB:CONTROLNET_...
My_PowerFlex_70_EC_Drive:I	{...}	{...}		AB:CONTROLNET_...
My_PowerFlex_70_EC_Drive:I.Data	{...}	{...}	Decimal	INT[12]
My_PowerFlex_70_EC_Drive:I.Data[0]	0		Decimal	INT
My_PowerFlex_70_EC_Drive:I.Data[1]	0		Decimal	INT
My_PowerFlex_70_EC_Drive:I.Data[2]	0		Decimal	INT
My_PowerFlex_70_EC_Drive:I.Data[3]	0		Decimal	INT
My_PowerFlex_70_EC_Drive:I.Data[4]	0		Decimal	INT
My_PowerFlex_70_EC_Drive:I.Data[5]	0		Decimal	INT
My_PowerFlex_70_EC_Drive:I.Data[6]	0		Decimal	INT
My_PowerFlex_70_EC_Drive:I.Data[7]	0		Decimal	INT
My_PowerFlex_70_EC_Drive:I.Data[8]	0		Decimal	INT
My_PowerFlex_70_EC_Drive:I.Data[9]	0		Decimal	INT
My_PowerFlex_70_EC_Drive:I.Data[10]	0		Decimal	INT
My_PowerFlex_70_EC_Drive:I.Data[11]	0		Decimal	INT
My_PowerFlex_70_EC_Drive:O	{...}	{...}		AB:CONTROLNET_...
My_PowerFlex_70_EC_Drive:O.Data	{...}	{...}	Decimal	INT[10]
My_PowerFlex_70_EC_Drive:O.Data[0]	0		Decimal	INT
My_PowerFlex_70_EC_Drive:O.Data[1]	0		Decimal	INT
My_PowerFlex_70_EC_Drive:O.Data[2]	0		Decimal	INT
My_PowerFlex_70_EC_Drive:O.Data[3]	0		Decimal	INT
My_PowerFlex_70_EC_Drive:O.Data[4]	0		Decimal	INT
My_PowerFlex_70_EC_Drive:O.Data[5]	0		Decimal	INT
My_PowerFlex_70_EC_Drive:O.Data[6]	0		Decimal	INT
My_PowerFlex_70_EC_Drive:O.Data[7]	0		Decimal	INT
My_PowerFlex_70_EC_Drive:O.Data[8]	0		Decimal	INT
My_PowerFlex_70_EC_Drive:O.Data[9]	0		Decimal	INT

### Save the I/O Configuration to the Controller

After adding the bridge and drive/adapter to the I/O configuration, you must download the configuration to the controller. You should also save the configuration as a file on your computer.



**TIP:** When using RSLogix 5000 software, version 16.00 or later, you can add the I/O configuration of a Generic Profile while the controller is online and in the Run mode.

1. In the RSLogix 5000 window, select **Communications > Download**.

The Download dialog box appears.

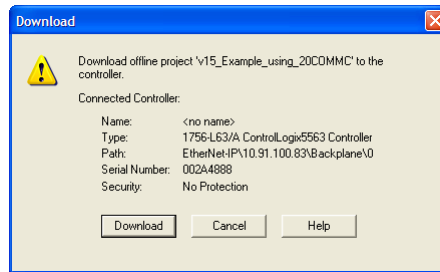

- **TIP:** If a message box reports that RSLogix 5000 software is unable to go online, select **Communications > Who Active** to find your controller in the Who Active screen. After finding and selecting the controller, click **Set Project Path** to establish the path. If your controller does not appear, you need to add or configure the ControlNet driver with RSLinx software. See [Using RSLinx Classic Software on page 4-1](#) and RSLinx online help for details.

2. Click **Download** to download the configuration to the controller.

When the download is successfully completed, RSLogix 5000 software goes into the Online mode and the I/O Not Responding box in the upper-left of the screen should be flashing green.

3. Select **File > Save**.

If this is the first time you saved the project, the Save As dialog box appears.

- a. Navigate to a folder.
- b. Type a file name.
- c. Click **Save** to save the configuration as a file on your computer.

To be sure that the present project configuration values are saved, RSLogix 5000 software prompts you to upload them. Click **Yes** to upload and save the values.

4. Configure any Datalinks in the drive (for example, Datalink parameters 300...317 in PowerFlex 70/700 drives) that were enabled in the controller and adapter during I/O configuration ([Table 4.A](#), [Table 4.B](#) or [Table 4.C](#)).

Each Datalink being used must be assigned to a specific parameter in the drive or connected peripheral. If this is not done, the controller will receive or send placeholder data instead of actual drive or peripheral parameter values.

5. Place the controller in Remote Run or Run Mode.

6. Use the procedure in the subsection [Use RSNetworx for ControlNet Software to Save the I/O to the Bridge on page 4-13](#) to:
  - Change the I/O Not Responding box in the upper-left of the RSLogix 5000 window from flashing green to steady green.
  - Remove the yellow warning symbols in the treeview under the I/O Configuration folder and drive profile.

## PLC-5 Controller Example

After the adapter is configured, the connected drive and adapter will be a single node on the network. This section provides the steps needed to configure a simple ControlNet network (see [Figure 4.5](#)). In our example, we will configure a PLC-5/40C controller to communicate with a drive using Logic Command/Status, Reference/Feedback, and Datalinks over the network.

**Figure 4.5 Example PLC-5 Controller ControlNet Network**

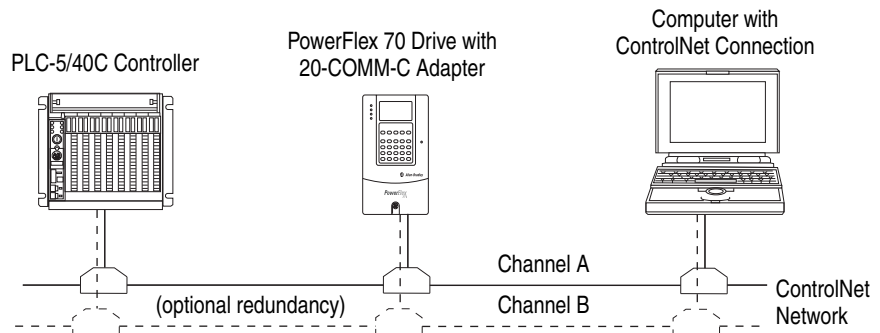

**TIP:** Information for PowerFlex 750-Series drives has been added to this manual where it is applicable.

## Configuring Parameters for Network I/O

Because the I/O for the drive is defined in the next subsection [Use RSNetWorx for ControlNet Software to Configure the I/O and Save It to the Controller on page 4-25](#), there is no need to configure any I/O inside the RSLogix 5 project, version 7.00 or later, until using the I/O as described in [Chapter 5](#).

However, to get the adapter to operate with the I/O created in [Chapter 5](#), you need to configure the adapter to accept the I/O and the drive to point to the appropriate Datalinks.

1. Set adapter **Parameters 13 - [DPI I/O Cfg]**, **25 - [M-S Input]**, and **26 - [M-S Output]** to values that meet your application requirements.

For this example, the adapter I/O parameters are set to these values.

Adapter Parameter No.	Setting
13 - [DPI I/O Cfg]	xxxx xxxx xxx1 1111
25 - [M-S Input]	xxxx xxxx xxx1 1111
26 - [M-S Output]	xxxx xxxx xxx1 1111

2. Reset the adapter (see [Resetting the Adapter on page 3-7](#)) or power cycle the drive.

For the drive speed reference and Datalink parameter values and the adapter setup parameter values, see [Drive and Adapter Parameter Settings on page 5-24](#).

### Use RSNetWorx for ControlNet Software to Configure the I/O and Save It to the Controller

To establish an I/O configuration that can be used between the controller and drive over a ControlNet network, you must first create an I/O image for the PLC-5/40C controller's built-in scanner.

1. Start RSNetWorx for ControlNet software.
2. In the RSNetWorx for ControlNet window, select **File > New** to display the New File screen.
3. Select 'ControlNet Configuration' as the network configuration type.
4. Click **OK**.
5. Select **Network > Online** to display the Browse for Network screen.

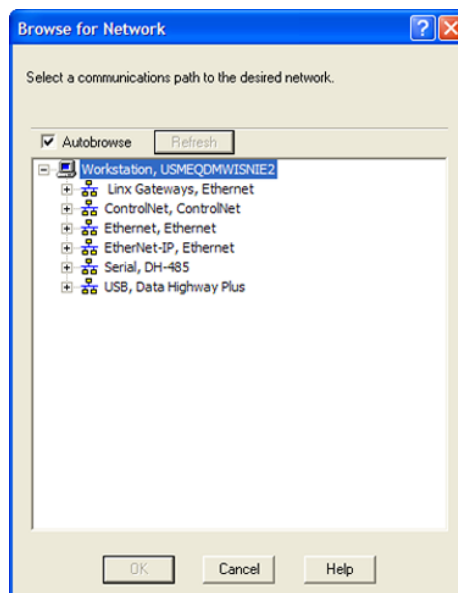

6. Expand the communication path from your computer to the PLC-5/40C controller.

The following screen shows our example navigating to devices that are on a ControlNet network. Depending on the communication link you are using, the navigation path may be different.

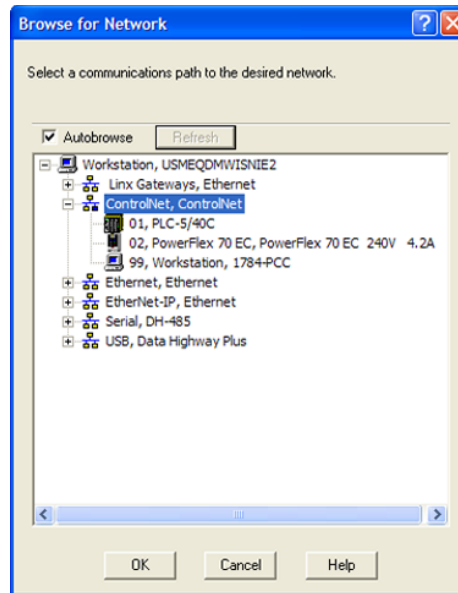

7. After selecting a valid path to the ControlNet network (for this example, ControlNet, ControlNet), click **OK**.

As the selected ControlNet path is browsed, RSNetWorx for ControlNet software creates a graph view window that shows a graphical representation of the devices on the network.

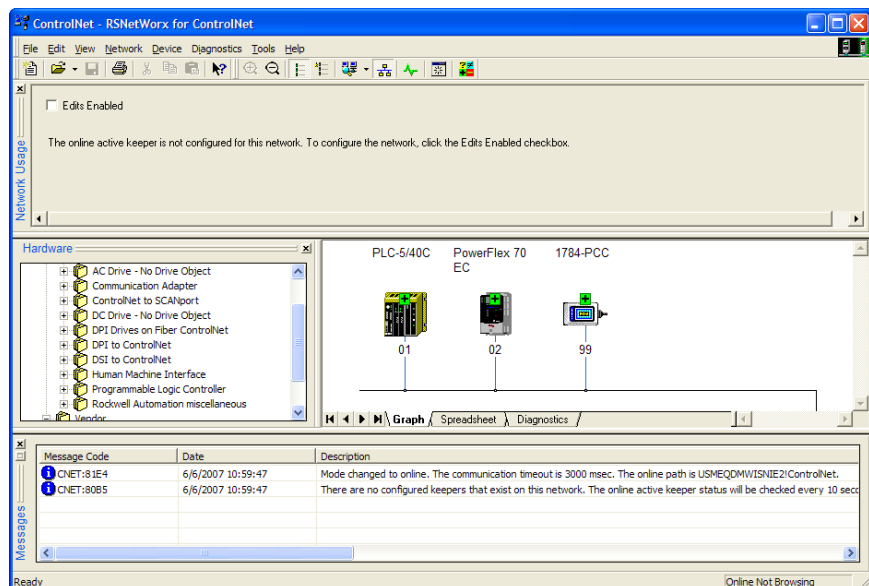

If the icon for the drive (for this example, PowerFlex 70 EC) on the network appears as Unrecognized Device, you must download the EDS file for that PowerFlex drive from the Rockwell Automation website.

- a. Go to the website <http://www.rockwellautomation.com/resources/eds>.

- b. On the website search screen in the Network entry field, enter the type of network (for this example, ControlNet), which enables the use of the other search fields.
- c. In the Keyword entry field, enter the type of PowerFlex drive (for this example, PowerFlex 70EC), noting that this field is space sensitive.
- d. Click **Search**.

Due to the large number of EDS files, this search may take seconds or up to several minutes.

- e. On the search results screen in the Details & Download Column, click the 'Download' hyperlink for the EDS file.
- f. Click **Save** on the File Download screen to save the EDS file to an appropriate location on your computer.
- g. Launch the EDS Hardware Installation Tool by clicking the Microsoft Windows Start button and selecting **Programs > Rockwell Software > RSLinx Tools > EDS Hardware Installation Tool**.

Follow the screen prompts to add the EDS file for use with your project.

- h. Reboot the computer and repeat steps 1 through 7 at the beginning of this subsection.

The Unrecognized Device icon in the RSNetWorx for ControlNet graph view window in step 7 should have been replaced by a drive icon (for this example, the icon for a PowerFlex 70 EC drive).

8. Select **Network > Enable Edits** or check the Edits Enabled box in the RSNetWorx for ControlNet project window.

If the PLC-5/40C controller has a different I/O configuration than the configuration now being saved, the Online/Offline mismatch dialog box will appear.

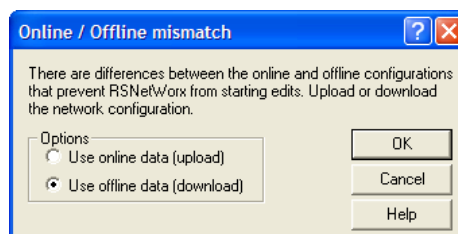

- a. When both Options choices are available, click 'Use offline data (download)'. When this choice is dimmed (grayed out), you must select 'Use online data (upload)'.
- b. Click **OK**.



**TIP:** If a message box reports that the download cannot be completed because the controller is not in Program mode, click **Change Mode** to place the controller in Remote Run mode and continue the download.

9. In the RSNetWorx for ControlNet graph view window, right-click the PLC-5/40C icon and choose **Scanlist Configuration** to display the Scanlist Configuration screen.

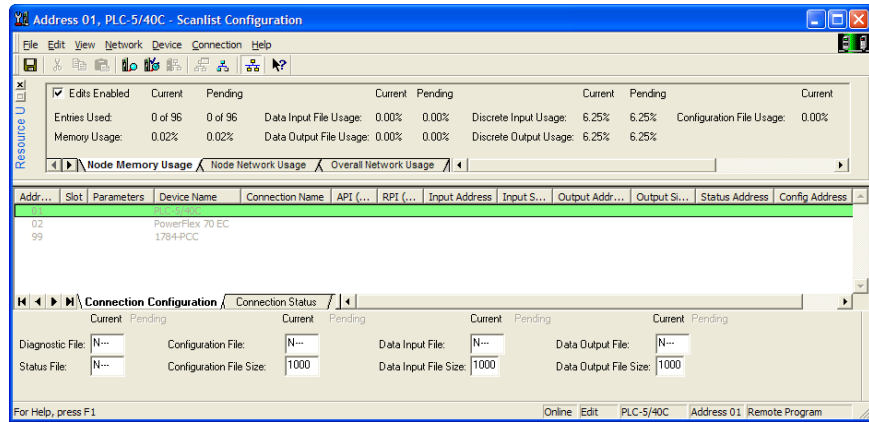

10. Right-click the PowerFlex 70 EC drive row in the screen and choose **Insert Connection...** to display the Connection Properties screen.

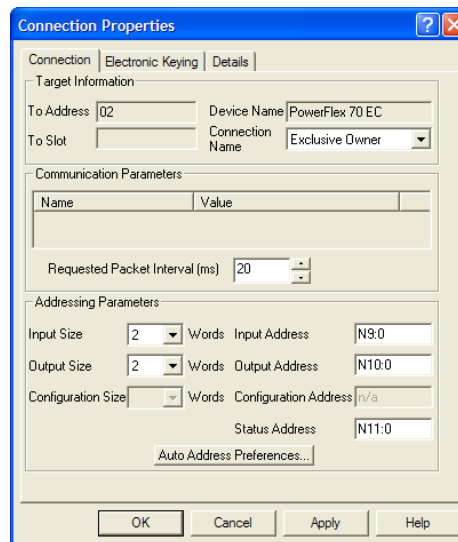

- a. In this screen, leave the Connection Name box at the default value shown.
- b. For the Requested Packet Interval box, choose a value that is suitable for your application, but is at least 5 ms.
- c. For the Input Size and Output Size boxes, use the pull-down menu to choose the number of words that are required for your I/O.

The size will depend on the I/O that you enabled in the adapter using **Parameter 13 - [DPI I/O Cfg]**. For this example, an Input Size of '10' and an Output Size of '10' are selected.

Depending on the size of the drive's Reference/Feedback and the number of Datalinks used in your I/O configuration, [Table 4.D](#), [Table 4.E](#), or [Table 4.F](#) defines the number of 16-bit words that you need to enter for the Input Size and Output Size boxes.



**Table 4.D Drives with 16-bit Reference/Feedback and 16-bit Datalinks**

These products include the following:

- PowerFlex 70 drives with standard or enhanced control
- PowerFlex 700 drives with standard control
- PowerFlex 700H drives
- SMC Flex smart motor controllers
- SMC-50 smart motor controllers

Logic Command/Status	Ref/Fdbk (16-bit)	Datalinks (16-bit)				User Configured Settings				
		A	B	C	D	Size in Words		Par. 13 - [DPI I/O Cfg]	Par. 25 - [M-S Input]	Par. 26 - [M-S Output]
						Input	Output			
✓	✓					2	2	...0 0001	...0 0001	...0 0001
✓	✓	✓				4	4	...0 0011	...0 0011	...0 0011
✓	✓	✓	✓			6	6	...0 0111	...0 0111	...0 0111
✓	✓	✓	✓	✓		8	8	...0 1111	...0 1111	...0 1111
✓	✓	✓	✓	✓	✓	10	10	...1 1111	...1 1111	...1 1111

**Table 4.E Drives with 16-bit Reference/Feedback and 32-bit Datalinks**

These products include the following:

- PowerFlex 700 drives with vector control
- PowerFlex 700L drives with 700 control
- PowerFlex Digital DC drives

Logic Command/Status	Ref/Fdbk (16-bit)	Datalinks (32-bit)				User Configured Settings				
		A	B	C	D	Size in Words		Par. 13 - [DPI I/O Cfg]	Par. 25 - [M-S Input]	Par. 26 - [M-S Output]
						Input	Output			
✓	✓					2	2	...0 0001	...0 0001	...0 0001
✓	✓	✓				6	6	...0 0011	...0 0011	...0 0011
✓	✓	✓	✓			10	10	...0 0111	...0 0111	...0 0111
✓	✓	✓	✓	✓		14	14	...0 1111	...0 1111	...0 1111
✓	✓	✓	✓	✓	✓	18	18	...1 1111	...1 1111	...1 1111

**Table 4.F Drives with 32-bit Reference/Feedback and 32-bit Datalinks**

These products include the following:

- PowerFlex 700S drives with Phase I or Phase II control
- PowerFlex 700L drives with 700S control
- PowerFlex 753 drives
- PowerFlex 755 drives

Logic Command/Status	Ref/Fdbk (32-bit)	Datalinks (32-bit)				User Configured Settings				
		A	B	C	D	Size in Words		Par. 13 - [DPI I/O Cfg]	Par. 25 - [M-S Input]	Par. 26 - [M-S Output]
						Input	Output			
✓	✓					4	4	...0 0001	...0 0001	...0 0001
✓	✓	✓				8	8	...0 0011	...0 0011	...0 0011
✓	✓	✓	✓			12	12	...0 0111	...0 0111	...0 0111
✓	✓	✓	✓	✓		16	16	...0 1111	...0 1111	...0 1111
✓	✓	✓	✓	✓	✓	20	20	...1 1111	...1 1111	...1 1111

► **TIP:** If necessary, the N9:0, N10:0, and N11:0 address defaults can be changed to meet processor address requirements or eliminate address conflicts.

**11. Click OK.**

An address row (in blue text) will be added below the PowerFlex 70 EC drive row.

12. Select **File > Save** to save the I/O configuration file to the PLC-5/40C controller.

The Save Configuration dialog box appears.

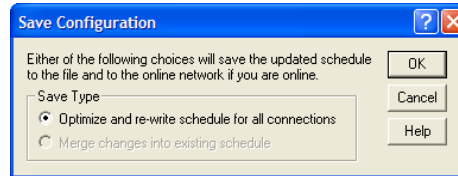

- ▶ **TIP:** If both Save Type choices are available, we recommend to click ‘Optimize and re-write schedule for all connections’.

13. Click **OK** to download the I/O configuration to the controller.

A warning will appear about communication and I/O disruption on the network.

14. Click **Yes**.

If this is the first time that you saved the project, the Save As dialog box appears.

- a. Navigate to a folder.
- b. Type a file name.
- c. Click **Save** to save the configuration as a file on your computer.

## SLC 500 Controller Example

After the adapter is configured, the connected drive and adapter will be a single node on the network. This section provides the steps needed to configure a simple ControlNet network (see [Figure 4.6](#)). In our example, we will configure a SLC 500 controller to communicate with a drive using Logic Command/Status, Reference/Feedback, and Datalinks over the network.

**Figure 4.6 Example SLC 500 Controller ControlNet Network**

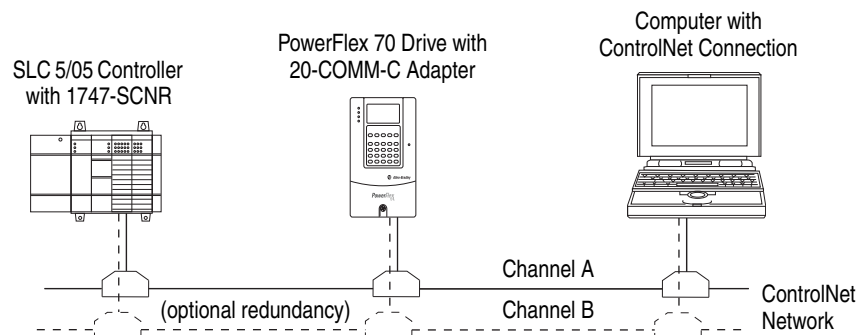

- ▶ **TIP:** Information for PowerFlex 750-Series drives has been added to this manual where it is applicable.

## Configuring Parameters for Network I/O

Because the I/O for the drive is defined in the next subsection [Use RSNetWorx for ControlNet Software to Configure the I/O and Save It to the 1747-SCNR Scanner on page 4-31](#), there is no need to configure any I/O inside the RSLogix 500 project, version 7.00 or later, until using the I/O as described in [Chapter 5](#).

However, to get the adapter to operate with the I/O created in [Chapter 5](#), you need to configure the adapter to accept the I/O and drive to point to the appropriate Datalinks.

1. Set adapter parameters **13 - [DPI I/O Cfg]**, **25 - [M-S Input]**, and **26 - [M-S Output]** to values that meet your application requirements.

For this example, the adapter I/O parameters are set to these values.

Adapter Parameter No.	Setting
13 - [DPI I/O Cfg]	xxxx xxxx xxx1 1111
25 - [M-S Input]	xxxx xxxx xxx1 1111
26 - [M-S Output]	xxxx xxxx xxx1 1111

2. Reset the adapter (see [Resetting the Adapter on page 3-7](#)) or power cycle the drive.

For the drive speed reference and Datalink parameter values and the adapter setup parameter values, see [Drive and Adapter Parameter Settings on page 5-40](#).

## Use RSNetWorx for ControlNet Software to Configure the I/O and Save It to the 1747-SCNR Scanner

To establish an I/O configuration that can be used between the controller and drive over a ControlNet network, you must first create an I/O image for the SLC 500 controller's 1747-SCNR scanner.

1. Start RSNetWorx for ControlNet software.
2. In the RSNetWorx for ControlNet window, select **File > New** to display the New File screen.
3. Select 'ControlNet Configuration' as the network configuration type.
4. Click **OK**.

5. Select **Network > Online** to display the Browse for Network screen.

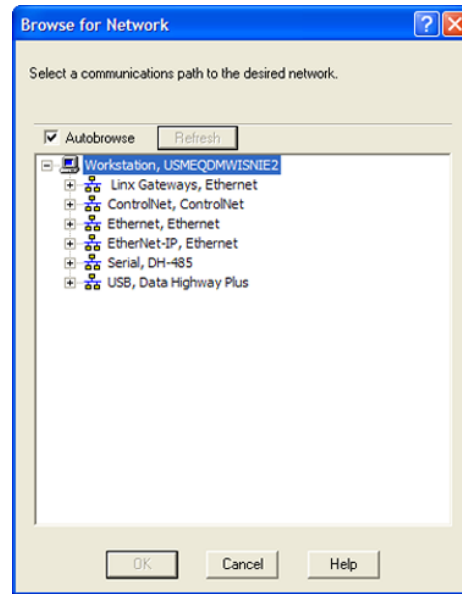

6. Expand the communication path from your computer to the 1747-SCNR scanner.

The following screen shows our example navigating to devices that are on a ControlNet network. Depending on the communication link you are using, the navigation path may be different.

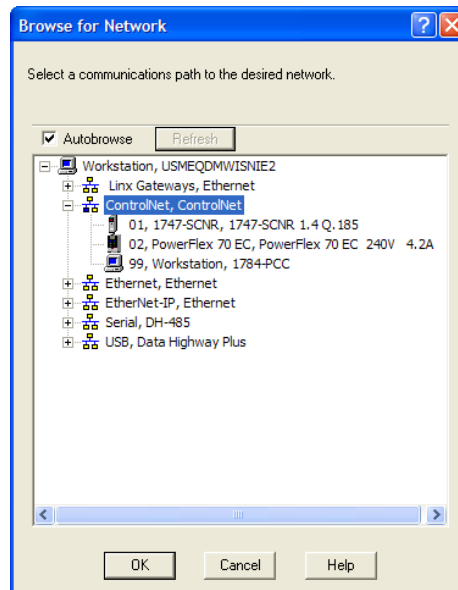

7. After selecting a valid path to the ControlNet network (for this example, ControlNet, ControlNet), click **OK**.

As the selected ControlNet path is browsed, RSNetWorx for ControlNet software creates a graph view window that shows a graphical representation of the devices on the network.

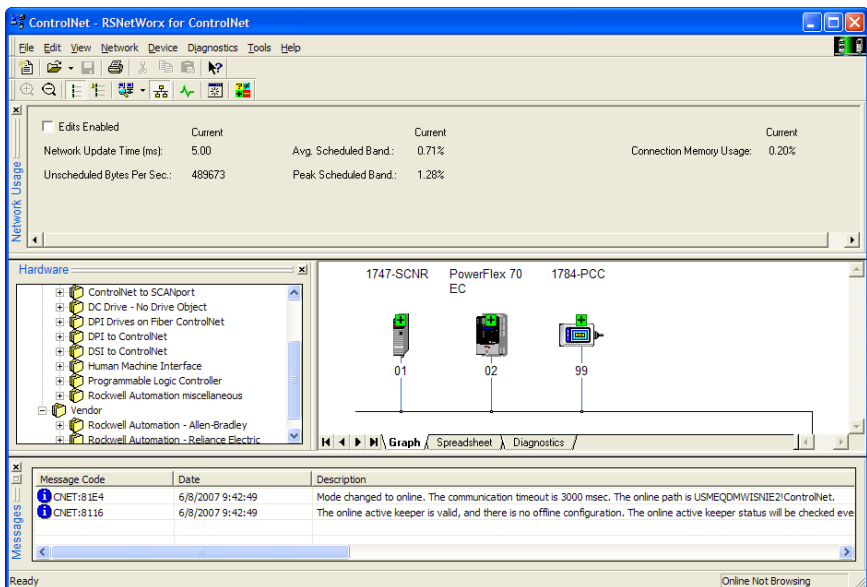

If the icon for the drive (for this example, PowerFlex 70 EC) on the network appears as Unrecognized Device, you must download the EDS file for that PowerFlex drive from the Rockwell Automation website.

- a. Go to the website <http://www.rockwellautomation.com/resources/eds>.
- b. On the website search screen in the Network entry field, enter the type of network (for this example, ControlNet), which enables the use of the other search fields.
- c. In the Keyword entry field, enter the type of PowerFlex drive (for this example, PowerFlex 70EC), noting that this field is space sensitive.
- d. Click **Search**.

Due to the large number of EDS files, this search may take seconds or up to several minutes.

- e. On the search results screen in the Details & Download Column, click the 'Download' hyperlink for the EDS file.
- f. Click **Save** on the File Download screen to save the EDS file to an appropriate location on your computer.
- g. Launch the EDS Hardware Installation Tool by clicking the Microsoft Windows Start button and selecting **Programs > Rockwell Software > RSLinx Tools > EDS Hardware Installation Tool**.

Follow the screen prompts to add the EDS file for use with your project.

- h. Reboot the computer and repeat steps 1 through 7 at the beginning of this subsection.

The Unrecognized Device icon in the RSNetWorx for ControlNet graph view window in step 7 should have been replaced by a drive icon (for this example, the icon for a PowerFlex 70 EC drive).

8. Select **Network > Enable Edits** or check the Edits Enabled box in the RSNetWorx for ControlNet project window.

If the 1747-SCNR scanner has a different I/O configuration than the configuration now being saved, the Online/Offline mismatch dialog box will appear.

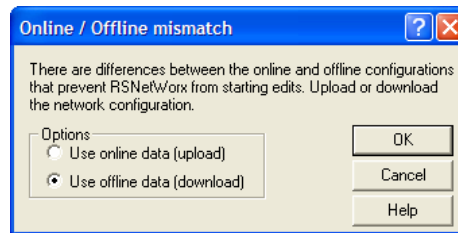

- a. When both Options choices are available, click ‘Use offline data (download)’. When this choice is dimmed (grayed out), you must click ‘Use online data (upload)’.
- b. Click **OK**.

▶ **TIP:** If a message box reports that the download cannot be completed because the controller is not in Program mode, click **Change Mode** to place the controller in Remote Run mode and continue the download.

9. In the RSNetWorx for ControlNet graph view window, right-click the 1747-SCNR icon and choose **Scanlist Configuration** to display the Scanlist Configuration screen.

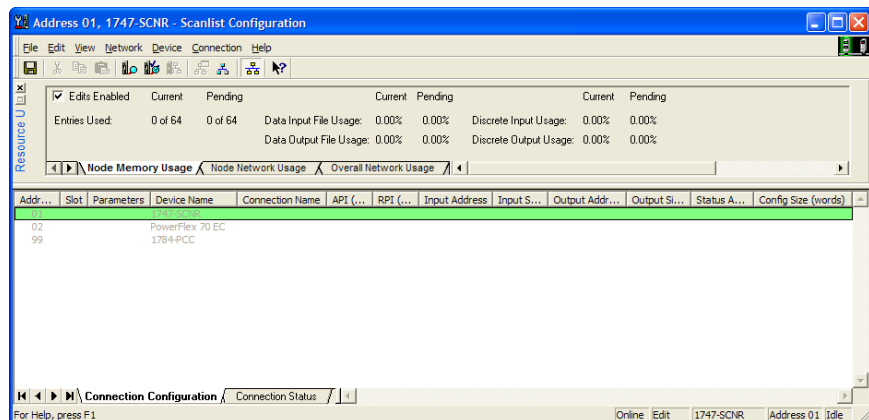

10. Right-click the PowerFlex 70 EC drive row in the screen and select **Insert Connection...** to display the Connection Properties screen.

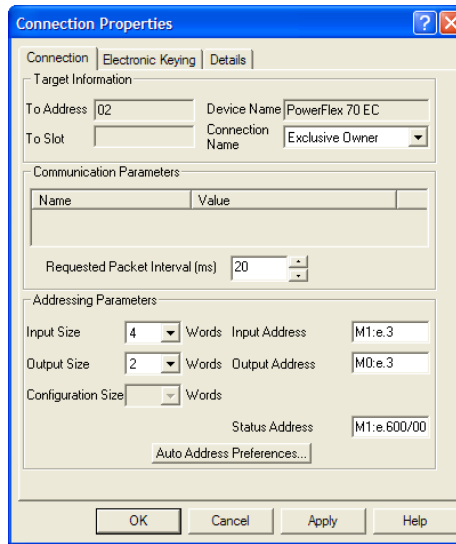

- a. In this screen, leave the Connection Name box at the default value shown.
- b. For the Requested Packet Interval box, choose a value that is suitable for your application, but is at least 5 ms.
- c. For the Input Size and Output Size boxes, use the pull-down menu to choose the number of words that are required for your I/O.

The size will depend on the I/O that you enabled in the adapter using **Parameter 13 - [DPI I/O Cfg]**. For this example, an Input Size of '12' and an Output Size of '10' are selected.

Depending on the size of the drive's Reference/Feedback and the number of Datalinks used in your I/O configuration, [Table 4.G](#), [Table 4.H](#), or [Table 4.I](#) defines the number of 16-bit words that you need to enter for the Input Size and Output Size boxes.

**Table 4.G Drives with 16-bit Reference/Feedback and 16-bit Datalinks**

These products include the following:

- PowerFlex 70 drives with standard or enhanced control
- PowerFlex 700 drives with standard control
- PowerFlex 700H drives
- SMC Flex smart motor controllers
- SMC-50 smart motor controllers

Logic Command/Status	Ref/Fdbk (16-bit)	Datalinks (16-bit)				User Configured Settings				
		A	B	C	D	Size in Words		Par. 13 - [DPI I/O Cfg]	Par. 25 - [M-S Input]	Par. 26 - [M-S Output]
						Input	Output			
✓	✓					4	2	...0 0001	...0 0001	...0 0001
✓	✓	✓				6	4	...0 0011	...0 0011	...0 0011
✓	✓	✓	✓			8	6	...0 0111	...0 0111	...0 0111
✓	✓	✓	✓	✓		10	8	...0 1111	...0 1111	...0 1111
✓	✓	✓	✓	✓	✓	12	10	...1 1111	...1 1111	...1 1111

**Table 4.H Drives with 16-bit Reference/Feedback and 32-bit Datalinks**

These products include the following:

- PowerFlex 700 drives with vector control
- PowerFlex Digital DC drives
- PowerFlex 700L drives with 700 control

Logic Command/Status	Ref/Fdbk (16-bit)	Datalinks (32-bit)				User Configured Settings				
		A	B	C	D	Size in Words		Par. 13 - [DPI I/O Cfg]	Par. 25 - [M-S Input]	Par. 26 - [M-S Output]
						Input	Output			
✓	✓					4	2	...0 0001	...0 0001	...0 0001
✓	✓	✓				8	6	...0 0011	...0 0011	...0 0011
✓	✓	✓	✓			12	10	...0 0111	...0 0111	...0 0111
✓	✓	✓	✓	✓		16	14	...0 1111	...0 1111	...0 1111
✓	✓	✓	✓	✓	✓	20	18	...1 1111	...1 1111	...1 1111

**Table 4.I Drives with 32-bit Reference/Feedback and 32-bit Datalinks**

These products include the following:

- PowerFlex 700S drives with Phase I or Phase II control
- PowerFlex 753 drives
- PowerFlex 700L drives with 700S control
- PowerFlex 755 drives

Logic Command/Status	Ref/Fdbk (32-bit)	Datalinks (32-bit)				User Configured Settings				
		A	B	C	D	Size in Words		Par. 13 - [DPI I/O Cfg]	Par. 25 - [M-S Input]	Par. 26 - [M-S Output]
						Input	Output			
✓	✓					6	4	...0 0001	...0 0001	...0 0001
✓	✓	✓				10	8	...0 0011	...0 0011	...0 0011
✓	✓	✓	✓			14	12	...0 0111	...0 0111	...0 0111
✓	✓	✓	✓	✓		18	16	...0 1111	...0 1111	...0 1111
✓	✓	✓	✓	✓	✓	22	20	...1 1111	...1 1111	...1 1111

11. Because N files are used in [Using the I/O, Chapter 5](#) and memory files cannot be used for 32-bit REAL (floating point) data, the default Input Address M1:e.3 and Output Address M0:e.3 will need to be converted later using COP instructions in the ladder logic program. For now, leave these address fields at their defaults, and click **OK**.

An address row (in blue text) will be added below the PowerFlex 70 EC drive row.

12. Select **File > Save** to save the I/O configuration file to the 1747-SCNR scanner.

The Save Configuration dialog box appears.

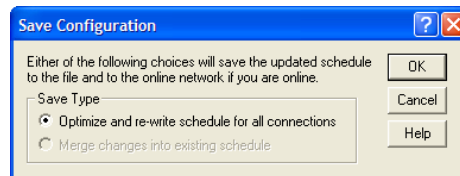

**TIP:** When both Save Type choices are available, we recommend to click the ‘Optimize and re-write schedule for all connections’.



**13. Click **OK** to download the I/O configuration to the scanner.**

A warning will appear about communication and I/O disruption on the network.

**14. Click **Yes**.**

If this is the first time that you saved the project, the Save As dialog box appears.

- a.** Navigate to a folder.
- b.** Type a file name.
- c.** Click **Save** to save the configuration as a file on your computer.

**Notes:**

## Using the I/O

This chapter provides information and examples that explain how to control, configure, and monitor a PowerFlex 7-Class drive using the configured I/O.

Topic	Page
<a href="#">About I/O Messaging</a>	<a href="#">5-1</a>
<a href="#">Understanding the I/O Image</a>	<a href="#">5-2</a>
<a href="#">Using Logic Command/Status</a>	<a href="#">5-8</a>
<a href="#">Using Reference/Feedback</a>	<a href="#">5-8</a>
<a href="#">Using Datalinks</a>	<a href="#">5-11</a>
<a href="#">Example Ladder Logic Program Information</a>	<a href="#">5-13</a>
<a href="#">ControlLogix Controller Example</a>	<a href="#">5-14</a>
<a href="#">PLC-5 Controller Example</a>	<a href="#">5-23</a>
<a href="#">SLC 500 Controller Example</a>	<a href="#">5-38</a>



**ATTENTION:** Risk of injury or equipment damage exists. The examples in this publication are intended solely for purposes of example. There are many variables and requirements with any application. Rockwell Automation does not assume responsibility or liability (to include intellectual property liability) for actual use of the examples shown in this publication.

### About I/O Messaging

On CIP-based networks, including ControlNet, I/O connections are used to transfer the data which controls the PowerFlex drive and sets its Reference. I/O can also be used to transfer data to and from Datalinks in PowerFlex 7-Class drives.

The adapter provides many options for configuring and using I/O, including the following:

- Configuring the size of I/O by enabling or disabling the Logic Command/Reference and Datalinks
- Setting a Master-Slave hierarchy

[Chapter 3, Configuring the Adapter](#), and [Chapter 4, Configuring the I/O](#), discuss how to configure the adapter and controller on the network for these options. The defines the different options. This chapter discusses how to use I/O after you have configured the adapter and controller.

**Understanding the I/O Image** The terms ‘input’ and ‘output’ are defined from the controller’s point of view. Therefore, output I/O is data that is produced by the controller and consumed by the adapter. Input I/O is status data that is produced by the adapter and consumed as input by the controller. The I/O image will vary based on the following:

- Size (either 16-bit or 32-bit) of the Reference/Feedback words and Datalink words used by the drive. To determine the size of the Reference/Feedback and Datalinks, view adapter **Parameters 07 - [Ref/Fdbk Size]** and **08 - [Datalink Size]**. For information to access parameters, see [Using the PowerFlex 7-Class HIM to Access Parameters on page 3-2](#).
- Configuration of I/O (**Parameter 13 - [DPI I/O Cfg]**). If all I/O is not enabled, the image is truncated. The image always uses consecutive words starting at word 0.
- **ControlLogix/CompactLogix Controllers only**—The drive profile used in RSLogix 5000 software (drive Add-on Profile in version 16.00 or later, Classic Profile in versions 13.00...15.00, or Generic Profile in all versions).

### ControlLogix Controller Image

Because the drive Add-on Profile in RSLogix 5000 software, version 16.00 or later, and the Classic Profile, versions 13.00...15.00, provide descriptive controller tags, the I/O image (tag size and location) is automatically configured based on the drive being used. When using the Generic Profile ([page 4-18](#)) in RSLogix 5000 software, however, controller tags are not descriptive or defined.

The ControlLogix controller I/O image changes depending on the size of the drive’s Reference/Feedback and Datalinks, and the number of Datalinks used. [Table 5.A](#), [Table 5.B](#), and [Table 5.C](#) show the I/O image when using various PowerFlex drives, and all Datalinks enabled.

**Table 5.A ControlLogix Controller I/O Image for Drives with 16-bit Reference/ Feedback and 16-bit Datalinks – Using Generic Profile**

These products include the following:

- PowerFlex 70 drives with standard or enhanced control
- PowerFlex 700 drives with standard control
- PowerFlex 700H drives
- SMC Flex smart motor controllers
- SMC-50 smart motor controllers

Word	Output I/O
0	Logic Command
1	Reference
2	Datalink In A1
3	Datalink In A2
4	Datalink In B1
5	Datalink In B2
6	Datalink In C1
7	Datalink In C2
8	Datalink In D1
9	Datalink In D2

Word	Input I/O
0	Pad Word
1	Pad Word
2	Logic Status
3	Feedback
4	Datalink Out A1
5	Datalink Out A2
6	Datalink Out B1
7	Datalink Out B2
8	Datalink Out C1
9	Datalink Out C2
10	Datalink Out D1
11	Datalink Out D2

**Table 5.B ControlLogix Controller I/O Image for Drives with 16-bit Reference/ Feedback and 32-bit Datalinks – Using Generic Profile**

These products include the following:

- PowerFlex 700 drives with vector control
- PowerFlex 700L drives with 700 control
- PowerFlex Digital DC drives

Word	Output I/O
0	Logic Command
1	Reference
2	Datalink In A1 (LSW)
3	Datalink In A1 (MSW)
4	Datalink In A2 (LSW)
5	Datalink In A2 (MSW)
6	Datalink In B1 (LSW)
7	Datalink In B1 (MSW)
8	Datalink In B2 (LSW)
9	Datalink In B2 (MSW)
10	Datalink In C1 (LSW)
11	Datalink In C1 (MSW)
12	Datalink In C2 (LSW)
13	Datalink In C2 (MSW)
14	Datalink In D1 (LSW)
15	Datalink In D1 (MSW)
16	Datalink In D2 (LSW)
17	Datalink In D2 (MSW)

Word	Input I/O
0	Pad Word
1	Pad Word
2	Logic Status
3	Feedback
4	Datalink Out A1 (LSW)
5	Datalink Out A1 (MSW)
6	Datalink Out A2 (LSW)
7	Datalink Out A2 (MSW)
8	Datalink Out B1 (LSW)
9	Datalink Out B1 (MSW)
10	Datalink Out B2 (LSW)
11	Datalink Out B2 (MSW)
12	Datalink Out C1 (LSW)
13	Datalink Out C1 (MSW)
14	Datalink Out C2 (LSW)
15	Datalink Out C2 (MSW)
16	Datalink Out D1 (LSW)
17	Datalink Out D1 (MSW)
18	Datalink Out D2 (LSW)
19	Datalink Out D2 (MSW)

**Table 5.C ControlLogix Controller I/O Image for Drives with 32-bit Reference/Feedback and 32-bit Datalinks – Using Generic Profile**

These products include the following:

- PowerFlex 700S drives with Phase I or Phase II control
- PowerFlex 700L drives with 700S control
- PowerFlex 753 drives
- PowerFlex 755 drives

Word	Output I/O	Word	Input I/O
0	Logic Command	0	Pad Word
1	Not Used	1	Pad Word
2	Reference (LSW)	2	Logic Status
3	Reference (MSW)	3	Not Used
4	Datalink In A1 (LSW)	4	Feedback (LSW)
5	Datalink In A1 (MSW)	5	Feedback (MSW)
6	Datalink In A2 (LSW)	6	Datalink Out A1 (LSW)
7	Datalink In A2 (MSW)	7	Datalink Out A1 (MSW)
8	Datalink In B1 (LSW)	8	Datalink Out A2 (LSW)
9	Datalink In B1 (MSW)	9	Datalink Out A2 (MSW)
10	Datalink In B2 (LSW)	10	Datalink Out B1 (LSW)
11	Datalink In B2 (MSW)	11	Datalink Out B1 (MSW)
12	Datalink In C1 (LSW)	12	Datalink Out B2 (LSW)
13	Datalink In C1 (MSW)	13	Datalink Out B2 (MSW)
14	Datalink In C2 (LSW)	14	Datalink Out C1 (LSW)
15	Datalink In C2 (MSW)	15	Datalink Out C1 (MSW)
16	Datalink In D1 (LSW)	16	Datalink Out C2 (LSW)
17	Datalink In D1 (MSW)	17	Datalink Out C2 (MSW)
18	Datalink In D2 (LSW)	18	Datalink Out D1 (LSW)
19	Datalink In D2 (MSW)	19	Datalink Out D1 (MSW)
		20	Datalink Out D2 (LSW)
		21	Datalink Out D2 (MSW)

### PLC-5 Controller Image

The I/O image for the PLC-5 controller changes depending on the size of the drive's Reference/Feedback and Datalinks, and the number of Datalinks used. [Table 5.D](#), [Table 5.E](#), and [Table 5.F](#) show the I/O image when using various PowerFlex drives, and all Datalinks enabled.

**Table 5.D PLC-5 Controller I/O Image for Drives with 16-bit Reference/Feedback and 16-bit Datalinks**

These products include the following:

- PowerFlex 70 drives with standard or enhanced control
- PowerFlex 700 drives with standard control
- PowerFlex 700H drives
- SMC Flex smart motor controllers
- SMC-50 smart motor controllers

Word	Output I/O
0	Logic Command
1	Reference
2	Datalink In A1
3	Datalink In A2
4	Datalink In B1
5	Datalink In B2
6	Datalink In C1
7	Datalink In C2
8	Datalink In D1
9	Datalink In D2

Word	Input I/O
0	Logic Status
1	Feedback
2	Datalink Out A1
3	Datalink Out A2
4	Datalink Out B1
5	Datalink Out B2
6	Datalink Out C1
7	Datalink Out C2
8	Datalink Out D1
9	Datalink Out D2

**Table 5.E PLC-5 Controller I/O Image for Drives with 16-bit Reference/Feedback and 32-bit Datalinks**

These products include the following:

- PowerFlex 700 drives with vector control
- PowerFlex 700L drives with 700 control
- PowerFlex Digital DC drives

Word	Output I/O
0	Logic Command
1	Reference
2	Datalink In A1 (LSW)
3	Datalink In A1 (MSW)
4	Datalink In A2 (LSW)
5	Datalink In A2 (MSW)
6	Datalink In B1 (LSW)
7	Datalink In B1 (MSW)
8	Datalink In B2 (LSW)
9	Datalink In B2 (MSW)
10	Datalink In C1 (LSW)
11	Datalink In C1 (MSW)
12	Datalink In C2 (LSW)
13	Datalink In C2 (MSW)
14	Datalink In D1 (LSW)
15	Datalink In D1 (MSW)
16	Datalink In D2 (LSW)
17	Datalink In D2 (MSW)

Word	Input I/O
0	Logic Status
1	Feedback
2	Datalink Out A1 (LSW)
3	Datalink Out A1 (MSW)
4	Datalink Out A2 (LSW)
5	Datalink Out A2 (MSW)
6	Datalink Out B1 (LSW)
7	Datalink Out B1 (MSW)
8	Datalink Out B2 (LSW)
9	Datalink Out B2 (MSW)
10	Datalink Out C1 (LSW)
11	Datalink Out C1 (MSW)
12	Datalink Out C2 (LSW)
13	Datalink Out C2 (MSW)
14	Datalink Out D1 (LSW)
15	Datalink Out D1 (MSW)
16	Datalink Out D2 (LSW)
17	Datalink Out D2 (MSW)

**Table 5.F PLC-5 Controller I/O Image for Drives with 32-bit Reference/Feedback and 32-bit Datalinks**

These products include the following:

- PowerFlex 700S drives with Phase I or Phase II control
- PowerFlex 700L drives with 700S control
- PowerFlex 753 drives
- PowerFlex 755 drives

Word	Output I/O
0	Logic Command
1	Not Used
2	Reference (LSW)
3	Reference (MSW)
4	Datalink In A1 (LSW)
5	Datalink In A1 (MSW)
6	Datalink In A2 (LSW)
7	Datalink In A2 (MSW)
8	Datalink In B1 (LSW)
9	Datalink In B1 (MSW)
10	Datalink In B2 (LSW)
11	Datalink In B2 (MSW)
12	Datalink In C1 (LSW)
13	Datalink In C1 (MSW)
14	Datalink In C2 (LSW)
15	Datalink In C2 (MSW)
16	Datalink In D1 (LSW)
17	Datalink In D1 (MSW)
18	Datalink In D2 (LSW)
19	Datalink In D2 (MSW)

Word	Input I/O
0	Logic Status
1	Not Used
2	Feedback (LSW)
3	Feedback (MSW)
4	Datalink Out A1 (LSW)
5	Datalink Out A1 (MSW)
6	Datalink Out A2 (LSW)
7	Datalink Out A2 (MSW)
8	Datalink Out B1 (LSW)
9	Datalink Out B1 (MSW)
10	Datalink Out B2 (LSW)
11	Datalink Out B2 (MSW)
12	Datalink Out C1 (LSW)
13	Datalink Out C1 (MSW)
14	Datalink Out C2 (LSW)
15	Datalink Out C2 (MSW)
16	Datalink Out D1 (LSW)
17	Datalink Out D1 (MSW)
18	Datalink Out D2 (LSW)
19	Datalink Out D2 (MSW)

### SLC 500 Controller Image

The I/O image for the SLC 500 controller changes depending on the size of the drive's Reference/Feedback and Datalinks, and the number of Datalinks used. [Table 5.G](#), [Table 5.H](#), and [Table 5.I](#) show the I/O image when using various PowerFlex drives, and all Datalinks enabled.



**Table 5.G SLC 500 Controller I/O Image for Drives with 16-bit Reference/Feedback and 16-bit Datalinks**

These products include the following:

- PowerFlex 70 drives with standard or enhanced control
- PowerFlex 700 drives with standard control
- PowerFlex 700H drives
- SMC Flex smart motor controllers
- SMC-50 smart motor controllers

Word	Output I/O
0	Logic Command
1	Reference
2	Datalink In A1
3	Datalink In A2
4	Datalink In B1
5	Datalink In B2
6	Datalink In C1
7	Datalink In C2
8	Datalink In D1
9	Datalink In D2

Word	Input I/O
0	Pad Word
1	Pad Word
2	Logic Status
3	Feedback
4	Datalink Out A1
5	Datalink Out A2
6	Datalink Out B1
7	Datalink Out B2
8	Datalink Out C1
9	Datalink Out C2
10	Datalink Out D1
11	Datalink Out D2

**Table 5.H SLC 500 Controller I/O Image for Drives with 16-bit Reference/Feedback and 32-bit Datalinks**

These products include the following:

- PowerFlex 700 drives with vector control
- PowerFlex 700L drives with 700 control
- PowerFlex Digital DC drives

Word	Output I/O
0	Logic Command
1	Reference
2	Datalink In A1 (LSW)
3	Datalink In A1 (MSW)
4	Datalink In A2 (LSW)
5	Datalink In A2 (MSW)
6	Datalink In B1 (LSW)
7	Datalink In B1 (MSW)
8	Datalink In B2 (LSW)
9	Datalink In B2 (MSW)
10	Datalink In C1 (LSW)
11	Datalink In C1 (MSW)
12	Datalink In C2 (LSW)
13	Datalink In C2 (MSW)
14	Datalink In D1 (LSW)
15	Datalink In D1 (MSW)
16	Datalink In D2 (LSW)
17	Datalink In D2 (MSW)

Word	Input I/O
0	Pad Word
1	Pad Word
2	Logic Status
3	Feedback
4	Datalink Out A1 (LSW)
5	Datalink Out A1 (MSW)
6	Datalink Out A2 (LSW)
7	Datalink Out A2 (MSW)
8	Datalink Out B1 (LSW)
9	Datalink Out B1 (MSW)
10	Datalink Out B2 (LSW)
11	Datalink Out B2 (MSW)
12	Datalink Out C1 (LSW)
13	Datalink Out C1 (MSW)
14	Datalink Out C2 (LSW)
15	Datalink Out C2 (MSW)
16	Datalink Out D1 (LSW)
17	Datalink Out D1 (MSW)
18	Datalink Out D2 (LSW)
19	Datalink Out D2 (MSW)

**Table 5.1 SLC 500 Controller I/O Image for Drives with 32-bit Reference/Feedback and 32-bit Datalinks**

These products include the following:

- PowerFlex 700S drives with Phase I or Phase II control
- PowerFlex 700L drives with 700S control
- PowerFlex 753 drives
- PowerFlex 755 drives

Word	Output I/O	Word	Input I/O
0	Logic Command	0	Pad Word
1	Not Used	1	Pad Word
2	Reference (LSW)	2	Logic Status
3	Reference (MSW)	3	Not Used
4	Datalink In A1 (LSW)	4	Feedback (LSW)
5	Datalink In A1 (MSW)	5	Feedback (MSW)
6	Datalink In A2 (LSW)	6	Datalink Out A1 (LSW)
7	Datalink In A2 (MSW)	7	Datalink Out A1 (MSW)
8	Datalink In B1 (LSW)	8	Datalink Out A2 (LSW)
9	Datalink In B1 (MSW)	9	Datalink Out A2 (MSW)
10	Datalink In B2 (LSW)	10	Datalink Out B1 (LSW)
11	Datalink In B2 (MSW)	11	Datalink Out B1 (MSW)
12	Datalink In C1 (LSW)	12	Datalink Out B2 (LSW)
13	Datalink In C1 (MSW)	13	Datalink Out B2 (MSW)
14	Datalink In C2 (LSW)	14	Datalink Out C1 (LSW)
15	Datalink In C2 (MSW)	15	Datalink Out C1 (MSW)
16	Datalink In D1 (LSW)	16	Datalink Out C2 (LSW)
17	Datalink In D1 (MSW)	17	Datalink Out C2 (MSW)
18	Datalink In D2 (LSW)	18	Datalink Out D1 (LSW)
19	Datalink In D2 (MSW)	19	Datalink Out D1 (MSW)
		20	Datalink Out D2 (LSW)
		21	Datalink Out D2 (MSW)

## Using Logic Command/Status

The Logic Command is a 16-bit word of control data produced by the controller and consumed by the adapter. The Logic Status is a 16-bit word of status data produced by the adapter and consumed by the controller. PowerFlex 750-Series drives have a 32-bit Logic Command/Status—but when using a 20-COMM-C or 20-COMM-Q adapter only the first 16 bits can be used.

This manual contains the bit definitions for most compatible products available at the time of publication in [Appendix D, Logic Command/Status Words](#). For other products, see their documentation.

## Using Reference/Feedback

The Reference is produced by the controller and consumed by the adapter. The Feedback is produced by the adapter and consumed by the controller. The size of the Reference/Feedback is determined by the drive and can be displayed with adapter **Parameter 07 - [Ref/Fdbk Size]**.

Size	Valid Values
16-bit	-32768 to 32767
32-bit	-2147483648 to 2147483647

When the Reference and Feedback are enabled, and a ControlLogix controller with a drive Add-on Profile or Classic Profile is used, specific controller tags are automatically created, sized (16-bit or 32-bit), and placed in the I/O image.

### PowerFlex 70/700/700H and PowerFlex 700L Drives with 700 Control

The Reference/Feedback value is a scaled engineering value; it is **not** in Hertz or RPM. The Reference uses a '32767' scale. The '32767' endpoint of the scale is equal to the value of drive parameter 55 - [Maximum Freq], which has a default value of 130 Hz. For these drives, default scaling is 0...15123 which is equal to 0...60.0 Hz. This is based on the formula shown below. Reference/Feedback scaling is limited by drive parameter 82 - [Maximum Speed]. If the default value of 60 Hz. for parameter 82 - [Maximum Speed] is changed, the speed Reference/Feedback scaling also changes. To determine Reference/Feedback scaling, use the following formula:

$$(\text{Parameter 82} \div \text{Parameter 55}) * 32767 = \text{Scaling}$$

Using drive parameter 82 and 55 default values, speed Reference/Feedback scaling is:

$$(60 \text{ Hz} \div 130 \text{ Hz}) * 32767 = 15123$$

Therefore, 0...15123 = 0...60.0 Hz.

If parameter 82 - [Maximum Speed] is changed to 90 Hz, then:

$$(90 \text{ Hz} \div 130 \text{ Hz}) * 32767 = 22685$$

Therefore, 0...22685 = 0...90.0 Hz.

A graphic representation of this Reference/Feedback scaling is shown below.

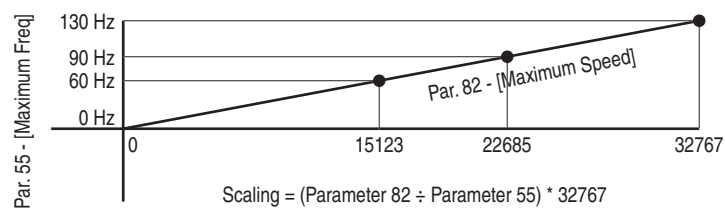

For PowerFlex 70 drives with enhanced control, firmware 2.xxx or later, or PowerFlex 700 drives with vector control, firmware 3.xxx or later, drive parameter 298 - [DPI Ref Select] was added to simplify scaling for the speed Reference/Feedback. When drive parameter 298 - [DPI Ref Select] is set to its default '0' (Max Freq), the speed Reference/Feedback scaling is as shown above. However, when parameter 298 - [DPI Ref Select] is set to '1' (Max Speed), the speed Reference/Feedback scaling is equal to parameter 82 - [Max Speed]:

#### Parameter 82 = Scaling

Using the parameter 82 default value, speed Reference/Feedback scaling is:

$$0...32767 = 0...60.0 \text{ Hz.}$$

If parameter 82 - [Maximum Speed] is changed to 90 Hz, then:

$$90 \text{ Hz} = 32767$$

Speed Feedback uses the same scaling as the speed Reference.



**TIP:** For PowerFlex 700 drives with vector control, firmware 3.xxx or later, parameter 299 - [DPI Fdbk Select] enables you to select the feedback data coming from the drive over DPI. The default is 'Speed Fdbk' in Hz or RPM determined by parameter 079 - [Speed Units]. The data selection for parameter 299 is also displayed on the 1st line of the HIM and on DriveExplorer and DriveExecutive software screens in the drive status area of the screen.

### PowerFlex 700S and PowerFlex 700L Drives with 700S Control

The Reference/Feedback value is:

$$32767 = \text{Base Motor Speed}$$

The base speed is set using drive parameter 4 - [Motor RPM]. To set a speed Reference/Feedback above base speed, a value greater than 32767 must be entered.

For 16-bit processors, such as PLC-5 and SLC 500 controllers, the data requires manipulation to set a speed Reference above 32767 or below -32767. Please see the PowerFlex 700S AC Drives Phase II Control Reference Manual, publication PFLEX-RM003, in the Chapter 1 'Communications' section. Then go to the 'PLC 5 or SLC System' subsection and see the 'Reference/Feedback Programming' sub-subsection.

### PowerFlex 753/755 Drives

The Reference/Feedback value is Hz x 1000 or RPM x 1000. Drive parameter 300 - [Speed Units] determines whether the scaling is Hz or RPM. The default scaling is Hz, where 0...60,000 equates to 0...60.000 Hz. When parameter 300 is set to RPM, then 0...1,765,000 equates to 0...1765.000 RPM.

For 16-bit processors, such as PLC-5 and SLC 500 controllers, the data requires manipulation to set a speed Reference above 32767 or below -32767. Please see the PowerFlex 700S AC Drives Phase II Control Reference Manual, publication PFLEX-RM003, in the Chapter 1 'Communications' section. Then go to the 'PLC 5 or SLC System' subsection and see the 'Reference/Feedback Programming' sub-subsection.

## PowerFlex Digital DC Drives

The Reference/Feedback value is:

$$25000 = \text{Maximum Reference Speed}$$

The maximum Reference speed is set using drive parameter 45 - [Max Ref Speed].

## Using Datalinks

A Datalink is a mechanism used by PowerFlex drives to transfer data to and from the controller. Datalinks allow a drive parameter value to be read or written without using an Explicit Message. When enabled, each Datalink occupies two 16-bit or 32-bit words in both the input and output image. Use adapter **Parameter 08 - [Datalink Size]** to determine whether the drive uses 16-bit or 32-bit words for Datalinks.

### Rules for Using Datalinks

- Each set of Datalink parameters in a PowerFlex drive can be used by only one adapter. If more than one adapter is connected to a single drive, multiple adapters cannot use the same Datalink.
- Parameter settings in the drive determine the data passed through the Datalink mechanism. See the documentation for your drive.
- When you use a Datalink to change a value, the value is **not** written to the Nonvolatile Storage (NVS) memory. The value is stored in volatile memory and lost when the drive loses power. Thus, use Datalinks when you need to change a value of a parameter frequently.

### Datalink Scaling

PowerFlex 70/700/700H Drives and PowerFlex 700L Drives with 700 Control

When using RSLogix 5000 software, version 16.00 or later, Datalink scaling is done automatically. However, when using RSLogix 5000 software, version 15.00 or earlier—or when using a PLC-5 or SLC 500 controller—Datalink scaling is not automatic and uses whole numbers (INTs or DINTs). See the drive documentation to determine the unit resolution for the associated parameter Datalink. For example, PowerFlex 700VC drive parameter 3 - [Output Current] has a 0.1 unit resolution. Because Datalink scaling uses whole numbers, the Output Current value is multiplied by 10 in the adapter and then sent over the network. Suppose the actual Output Current value is 35.5 amps. Reading the associated parameter Datalink received by the controller, the value would be 355. By using ladder logic, divide the value by 10 in the controller to get the correct scaling. See the drive documentation to determine if the Datalink parameter is a 16-bit or 32-bit parameter.

## PowerFlex 700S, PowerFlex 700L with 700S Control, PowerFlex 753/755, and PowerFlex Digital DC Drives

When using RSLogix 5000 software, version 16.00 or later, Datalink scaling is done automatically. However, when using RSLogix 5000 software, version 15.00 or earlier—or when using a PLC-5 or SLC 500 controller—Datalinks require scaling in the following way. Parameters are either 16-bit or 32-bit integers or REALs. When the parameter is a 32-bit integer, the data needs to be copied using a COP command to a DINT tag. (Because PLC-5 and SLC 500 controllers do not support 32-bit integers, the data must be separated into two 16-bit integers.) When the parameter is a REAL, the data needs to be copied using a COP command to a REAL tag. See subsequent sections in this chapter for ladder logic examples. See the drive documentation to determine if the Datalink parameter is a 16-bit or 32-bit integer parameter, or a REAL parameter.

### Using 16-Bit Datalinks to Read/Write 32-Bit Parameters

This subsection only pertains to PowerFlex 70 (standard or enhanced control), PowerFlex 700 (standard control), and PowerFlex 700H drives which use 16-bit Datalinks. To read or write a 32-bit parameter using 16-bit Datalinks, typically both Datalinks of a pair (A, B, C, D) are set to the same 32-bit parameter. For example, to read parameter 10 - [Elapsed Run Time] in a PowerFlex 70 drive, both Datalink A1 Out (Parameter 310) and Datalink A2 Out (Parameter 311) are set to '10'. Datalink A1 Out will contain the least significant word (LSW) and Datalink A2 Out will contain the most significant word (MSW).

32-bit data is stored in binary as follows:

MSW	$2^{31}$ through $2^{16}$
LSW	$2^{15}$ through $2^0$

In this example, the parameter 10 - [Elapsed Run Time] value of 6553.9 Hrs is read as '6553.9' in Datalink A1 Out (Parameter 310) and Datalink A2 Out (Parameter 311).

Datalink	Word	Parameter	Data (Hex)
A1 Out	LSW	10	0003
A2 Out	MSW	10	0001

#### Conversion Example:

Parameter 010 - [Elapsed Run Time] = 6553.9 Hrs  
 MSW =  $0001_{\text{hex}} = 0001_{\text{binary}} = 2^{16} = 65536$   
 LSW =  $0003_{\text{hex}} = 3$   
 Engineering Value =  $65536 + 3 = 65539$   
 Parameter 10 Displayed Value = 6553.9 Hrs

Regardless of the Datalink combination, Datalink x1 Out will always contain the LSW and Datalink x2 Out will always contain the MSW. In the following example, the PowerFlex 70 drive parameter 242 - [Power Up Marker] contains a value of 88.4541 hours.

Datalink	Word	Parameter	Data (Hex)
A2 Out	MSW	242	000D
B1 Out	LSW	242	7F3D

Conversion Example:

Parameter 242 - [Power Up Marker] = 88.4541 hours  
 MSW = 000D<sub>hex</sub> = 1101<sub>binary</sub> =  $2^{19} + 2^{18} + 2^{16} = 851968$   
 LSW = 7F3D<sub>hex</sub> = 32573  
 Engineering Value = 851968 + 32573 = 884541  
 Parameter 242 Displayed Value = 88.4541 Hrs

## Example Ladder Logic Program Information

The example ladder logic programs in the sections of this chapter are intended for and operate PowerFlex 7-Class drives.

### Functions of the Example Programs

The example programs enable you to do the following:

- Receive Logic Status information from the drive.
- Send a Logic Command to control the drive (for example, start, stop).
- Send a Reference to the drive and receive Feedback from the drive.
- Send/receive Datalink data to/from the drive.

### Logic Command/Status Words

These examples use the Logic Command word and Logic Status word for PowerFlex 70/700 drives. Information for PowerFlex 750-Series drives has been added to examples where applicable. See [Appendix D](#) to view details. The definition of the bits in these words may vary if you are using a different DPI drive. See the documentation for your drive.

## ControlLogix Controller Example

You can use any of RSLogix 5000 software versions to create the ladder logic. These are described in separate sections below. If your version of RSLogix 5000 software supports drive Add-on Profiles, we recommend that you use this method.

### Creating Ladder Logic Using the RSLogix 5000 Drive Add-on Profiles, Version 16.00 or Later

Because the drive Add-on Profile automatically created descriptive controller tags ([Figure 4.2](#)) for the entire I/O image in [Chapter 4](#), you can use these tags to directly control and monitor the drive without creating any ladder logic program. However, if you intend to use Human Machine Interface devices (PanelView, and so forth) to operate the drive and view its status, you will need to create descriptive user-defined Program tags ([Figure 5.1](#)) and a ladder logic program that will pass the Controller tag data to the Program tags.

**Figure 5.1 ControlLogix Program Tags for Drive Add-on Profile Ladder Logic Program Example**

Name	△	Style	Data Type
Command_Clear_Faults		Decimal	BOOL
Command_Forward_Reverse		Decimal	BOOL
Command_Jog		Decimal	BOOL
Command_Start		Decimal	BOOL
Command_Stop		Decimal	BOOL
+ Speed_Feedback		Decimal	DINT
+ Speed_Reference		Decimal	DINT
Status_Active		Decimal	BOOL
Status_At_Speed		Decimal	BOOL
Status_Faulted		Decimal	BOOL
Status_Forward		Decimal	BOOL
Status_Ready		Decimal	BOOL
Status_Reverse		Decimal	BOOL

An example ladder logic program that uses the automatically-created descriptive Controller tags and passes their data to the user-defined Program tags is shown in [Figure 5.2](#) and [Figure 5.3](#). Note that the prefix for the drive Controller tags is determined by the name assigned when configuring the I/O ([Chapter 4](#)).

Depending on the drive being used, see one of the following subsections for information on speed Reference and Feedback scaling.

Subsection	Page
<a href="#">PowerFlex 70/700/700H and PowerFlex 700L Drives with 700 Control</a>	<a href="#">5-9</a>
<a href="#">PowerFlex 700S and PowerFlex 700L Drives with 700S Control</a>	<a href="#">5-10</a>
<a href="#">PowerFlex 753/755 Drives</a>	<a href="#">5-10</a>
<a href="#">PowerFlex Digital DC Drives</a>	<a href="#">5-11</a>



**Figure 5.2 ControlLogix Example Ladder Logic Program Using a Drive Add-on Profile for Logic Status/Feedback**

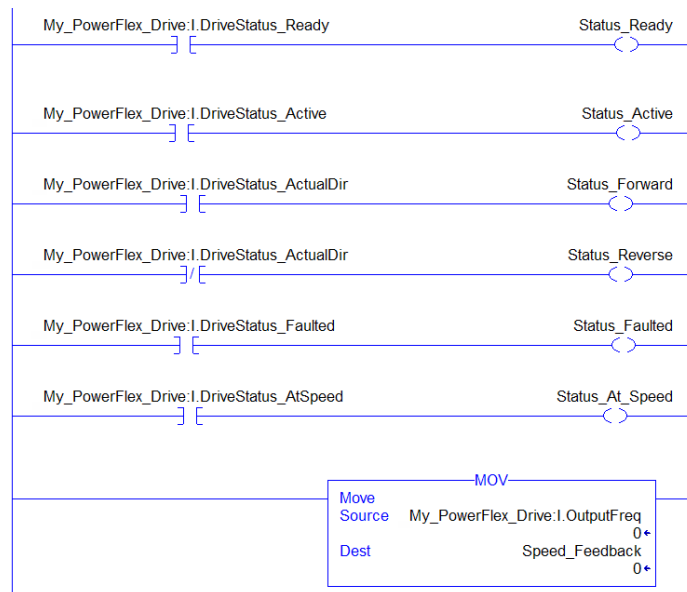

**Figure 5.3 ControlLogix Example Ladder Logic Program Using a Drive Add-on Profile for Logic Command/Reference**

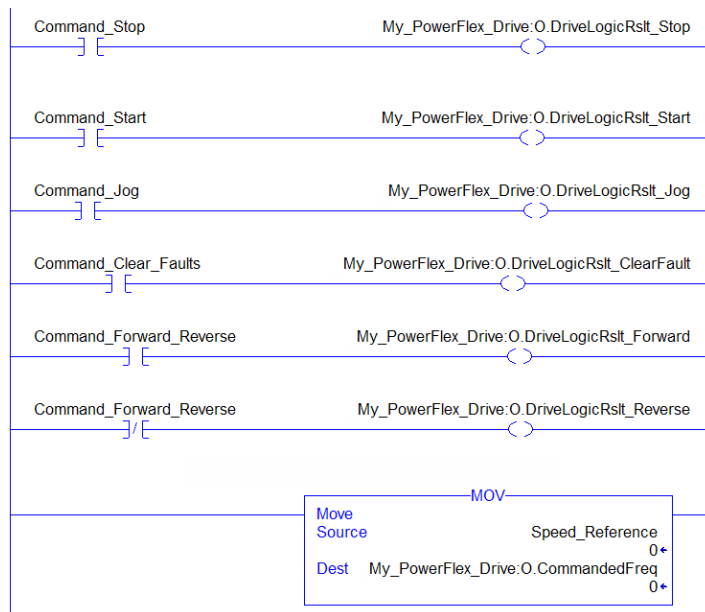

### Creating Ladder Logic Using the RSLogix 5000 Classic Profile, Versions 13.00...15.00

Because the RSLogix 5000 Classic Profile has been significantly improved upon by RSLogix 5000 drive Add-on Profiles, version 16.00 or later, we recommend using the RSLogix 5000 drive Add-on Profiles to take advantage of their benefits (more intuitive, time saving, and less likely to make ladder logic program errors).

## Creating Ladder Logic Using the RSLogix 5000 Generic Profile, All Versions

### Drive and Adapter Parameter Settings

The following drive and adapter settings were used for the example ladder logic program in this section.

Device	Parameter	Value	Description
PowerFlex 70 EC Drive	90 - [Speed Ref A Sel]	22 (DPI Port 5)	Assigns 20-COMM-C/-Q to be used for the Reference.
	300 - [Data In A1]	140	Points to Par. 140 - [Accel Time 1]
	301 - [Data In A2]	142	Points to Par. 142 - [Decel Time 1]
	302 - [Data In B1]	100	Points to Par. 100 - [Jog Speed]
	303 - [Data In B2]	155	Points to Par. 155 - [Stop Mode A]
	304 - [Data In C1]	101	Points to Par. 101 - [Preset Speed 1]
	305 - [Data In C2]	102	Points to Par. 102 - [Preset Speed 2]
	306 - [Data In D1]	103	Points to Par. 103 - [Preset Speed 3]
	307 - [Data In D2]	104	Points to Par. 104 - [Preset Speed 4]
	310 - [Data Out A1]	140	Points to Par. 140 - [Accel Time 1]
	311 - [Data Out A2]	142	Points to Par. 142 - [Decel Time 1]
	312 - [Data Out B1]	100	Points to Par. 100 - [Jog Speed]
	313 - [Data Out B2]	155	Points to Par. 155 - [Stop Mode A]
	314 - [Data Out C1]	101	Points to Par. 101 - [Preset Speed 1]
	315 - [Data Out C2]	102	Points to Par. 102 - [Preset Speed 2]
	316 - [Data Out D1]	103	Points to Par. 103 - [Preset Speed 3]
	317 - [Data Out D2]	104	Points to Par. 104 - [Preset Speed 4]
PowerFlex 750-Series Drive <sup>(1)</sup>	545 - [Spd Ref A Sel]	Port 0: Port 6 Reference	Assigns 20-COMM-C/Q to be used for the Reference.
	895 - [Data In A1]	Port 0: Accel Time 1	Points to Par. 535 in the drive.
	896 - [Data In A2]	Port 0: Testpoint Sel 1	Points to Par. 970 in the drive.
	897 - [Data In B1]	Port 5: Anlg Out1 Hi	Points to Par. 90 in Port 5 (I/O module).
	905 - [Data Out A1]	Port 0: DC Bus Volts	Points to Par. 11 in the drive.
	906 - [Data Out A2]	Port 0: Open Loop Fdbk	Points to Par. 137 in the drive.
	907 - [Data Out B1]	Port 5: Anlg Out0 Data	Points to Par. 77 in Port 5 (I/O module).
20-COMM-C or 20-COMM-Q Adapter	03 - [CN Addr Cfg]	2	Node address for the adapter.
	13 - [DPI I/O Cfg]	xxx1 1111	Enables Cmd/Ref and Datalinks A...D.
	25 - [M-S Input]	xxx1 1111	Configures the I/O Data to be transferred from the controller on the network to the drive.
	26 - [M-S Output]	xxx1 1111	Configures the I/O Data to be transferred from the drive to the controller on the network.

<sup>(1)</sup> In this example, the 20-COMM-C or 20-COMM-Q adapter/20-750-20COMM Communication Carrier Card is installed in Port 6, and a 24V I/O module is installed in Port 5. Also, Data In B2...D2 (Parameters 898...902) and Data Out B2...D2 (Parameters 908...912) are enabled, but not used.



**TIP:** Data In parameters are inputs into the drive that come from controller outputs (for example, data to write to a drive parameter). Data Out parameters are outputs from the drive that go to controller inputs (for example, data to read a drive parameter).

### Controller Tags

When you add the adapter and drive to the I/O configuration ([Chapter 4](#)), RSLogix 5000 software automatically creates generic (non-descriptive) controller tags for them. In this example program, the following controller tags are used.

**Figure 5.4** ControlLogix Controller Tags for Drive Generic Profile Example Ladder Logic Program

Name	Δ	Data Type	Description
My_PowerFlex_Drive:C		AB:CONTR...	
My_PowerFlex_Drive:I		AB:CONTR...	
My_PowerFlex_Drive:O		AB:CONTR...	

You can expand the Input and Output tags to reveal the input and output configuration.

**Figure 5.5** ControlLogix Input Image for Drive Generic Profile Example Ladder Logic Program

Name	Δ	Data Type	Description
My_PowerFlex_Drive:I		AB:CONTR...	
My_PowerFlex_Drive:I.Data		INT[12]	Input Image
My_PowerFlex_Drive:I.Data[0]		INT	Pad Word
My_PowerFlex_Drive:I.Data[1]		INT	Pad Word
My_PowerFlex_Drive:I.Data[2]		INT	Logic Status
My_PowerFlex_Drive:I.Data[3]		INT	Speed Feedback
My_PowerFlex_Drive:I.Data[4]		INT	Datalink Out A1
My_PowerFlex_Drive:I.Data[5]		INT	Datalink Out A2
My_PowerFlex_Drive:I.Data[6]		INT	Datalink Out B1
My_PowerFlex_Drive:I.Data[7]		INT	Datalink Out B2
My_PowerFlex_Drive:I.Data[8]		INT	Datalink Out C1
My_PowerFlex_Drive:I.Data[9]		INT	Datalink Out C2
My_PowerFlex_Drive:I.Data[10]		INT	Datalink Out D1
My_PowerFlex_Drive:I.Data[11]		INT	Datalink Out D2

PowerFlex 70 Drive  
16-bit Speed Feedback and Datalinks

Name	Δ	Data Type	Description
My_PowerFlex_Drive:I		AB:CONTR...	
My_PowerFlex_Drive:I.Data		INT[22]	Input Image
My_PowerFlex_Drive:I.Data[0]		INT	Pad Word
My_PowerFlex_Drive:I.Data[1]		INT	Pad Word
My_PowerFlex_Drive:I.Data[2]		INT	Logic Status
My_PowerFlex_Drive:I.Data[3]		INT	Not Used
My_PowerFlex_Drive:I.Data[4]		INT	FeedBack (LSW)
My_PowerFlex_Drive:I.Data[5]		INT	FeedBack (MSW)
My_PowerFlex_Drive:I.Data[6]		INT	Datalink Out A1 (LSW)
My_PowerFlex_Drive:I.Data[7]		INT	Datalink Out A1 (MSW)
My_PowerFlex_Drive:I.Data[8]		INT	Datalink Out A2 (LSW)
My_PowerFlex_Drive:I.Data[9]		INT	Datalink Out A2 (MSW)
My_PowerFlex_Drive:I.Data[10]		INT	Datalink Out B1 (LSW)
My_PowerFlex_Drive:I.Data[11]		INT	Datalink Out B1 (MSW)
My_PowerFlex_Drive:I.Data[12]		INT	Datalink Out B2 (LSW)
My_PowerFlex_Drive:I.Data[13]		INT	Datalink Out B2 (MSW)
My_PowerFlex_Drive:I.Data[14]		INT	Datalink Out C1 (LSW)
My_PowerFlex_Drive:I.Data[15]		INT	Datalink Out C1 (MSW)
My_PowerFlex_Drive:I.Data[16]		INT	Datalink Out C2 (LSW)
My_PowerFlex_Drive:I.Data[17]		INT	Datalink Out C2 (MSW)
My_PowerFlex_Drive:I.Data[18]		INT	Datalink Out D1 (LSW)
My_PowerFlex_Drive:I.Data[19]		INT	Datalink Out D1 (MSW)
My_PowerFlex_Drive:I.Data[20]		INT	Datalink Out D2 (LSW)
My_PowerFlex_Drive:I.Data[21]		INT	Datalink Out D2 (MSW)

PowerFlex 750-Series Drive  
32-bit Speed Feedback and Datalinks

**Figure 5.6 ControlLogix Output Image for Drive Generic Profile Example Ladder Logic Program**

Name	Data Type	Description
My_PowerFlex_Drive:0	AB:CONTR...	
My_PowerFlex_Drive:0.Data	INT[10]	Output Image
My_PowerFlex_Drive:0.Data[0]	INT	Logic Command
My_PowerFlex_Drive:0.Data[1]	INT	Speed Reference
My_PowerFlex_Drive:0.Data[2]	INT	Datalink In A1
My_PowerFlex_Drive:0.Data[3]	INT	Datalink In A2
My_PowerFlex_Drive:0.Data[4]	INT	Datalink In B1
My_PowerFlex_Drive:0.Data[5]	INT	Datalink In B2
My_PowerFlex_Drive:0.Data[6]	INT	Datalink In C1
My_PowerFlex_Drive:0.Data[7]	INT	Datalink In C2
My_PowerFlex_Drive:0.Data[8]	INT	Datalink In D1
My_PowerFlex_Drive:0.Data[9]	INT	Datalink In D2

PowerFlex 70 Drive  
16-bit Speed Reference and  
Datalinks

Name	Data Type	Description
My_PowerFlex_Drive:0	AB:CONTR...	
My_PowerFlex_Drive:0.Data	INT[20]	Output Image
My_PowerFlex_Drive:0.Data[0]	INT	Logic Command
My_PowerFlex_Drive:0.Data[1]	INT	Not Used
My_PowerFlex_Drive:0.Data[2]	INT	Reference (LSW)
My_PowerFlex_Drive:0.Data[3]	INT	Reference (MSW)
My_PowerFlex_Drive:0.Data[4]	INT	Datalink In A1 (LSW)
My_PowerFlex_Drive:0.Data[5]	INT	Datalink In A1 (MSW)
My_PowerFlex_Drive:0.Data[6]	INT	Datalink In A2 (LSW)
My_PowerFlex_Drive:0.Data[7]	INT	Datalink In A2 (MSW)
My_PowerFlex_Drive:0.Data[8]	INT	Datalink In B1 (LSW)
My_PowerFlex_Drive:0.Data[9]	INT	Datalink In B1 (MSW)
My_PowerFlex_Drive:0.Data[10]	INT	Datalink In B2 (LSW)
My_PowerFlex_Drive:0.Data[11]	INT	Datalink In B2 (MSW)
My_PowerFlex_Drive:0.Data[12]	INT	Datalink In C1 (LSW)
My_PowerFlex_Drive:0.Data[13]	INT	Datalink In C1 (MSW)
My_PowerFlex_Drive:0.Data[14]	INT	Datalink In C2 (LSW)
My_PowerFlex_Drive:0.Data[15]	INT	Datalink In C2 (MSW)
My_PowerFlex_Drive:0.Data[16]	INT	Datalink In D1 (LSW)
My_PowerFlex_Drive:0.Data[17]	INT	Datalink In D1 (MSW)
My_PowerFlex_Drive:0.Data[18]	INT	Datalink In D2 (LSW)
My_PowerFlex_Drive:0.Data[19]	INT	Datalink In D2 (MSW)

PowerFlex 750-Series Drive  
32-bit Speed Reference and  
Datalinks

### Program Tags

To use the Controller tags that are automatically created, you need to create the following Program tags for this example program.

**Figure 5.7 ControlLogix Program Tags for Drive Generic Profile Example Ladder Logic Program**

Name	Style	Data Type
Command_Clear_Faults	Decimal	BOOL
Command_Forward_Reverse	Decimal	BOOL
Command_Jog	Decimal	BOOL
Command_Start	Decimal	BOOL
Command_Stop	Decimal	BOOL
Speed_Feedback	Decimal	DINT
Speed_Reference	Decimal	DINT
Status_Active	Decimal	BOOL
Status_At_Speed	Decimal	BOOL
Status_Faulted	Decimal	BOOL
Status_Forward	Decimal	BOOL
Status_Ready	Decimal	BOOL
Status_Reverse	Decimal	BOOL

Depending on the drive being used, see one of the following subsections for information on speed Reference and Feedback scaling.

Subsection	Page
<a href="#">PowerFlex 70/700/700H and PowerFlex 700L Drives with 700 Control</a>	<a href="#">5-9</a>
<a href="#">PowerFlex 700S and PowerFlex 700L Drives with 700S Control</a>	<a href="#">5-10</a>
<a href="#">PowerFlex 753/755 Drives</a>	<a href="#">5-10</a>
<a href="#">PowerFlex Digital DC Drives</a>	<a href="#">5-11</a>

**Figure 5.8 ControlLogix Example Ladder Logic Program Using a Drive Generic Profile for Logic Status/Feedback**

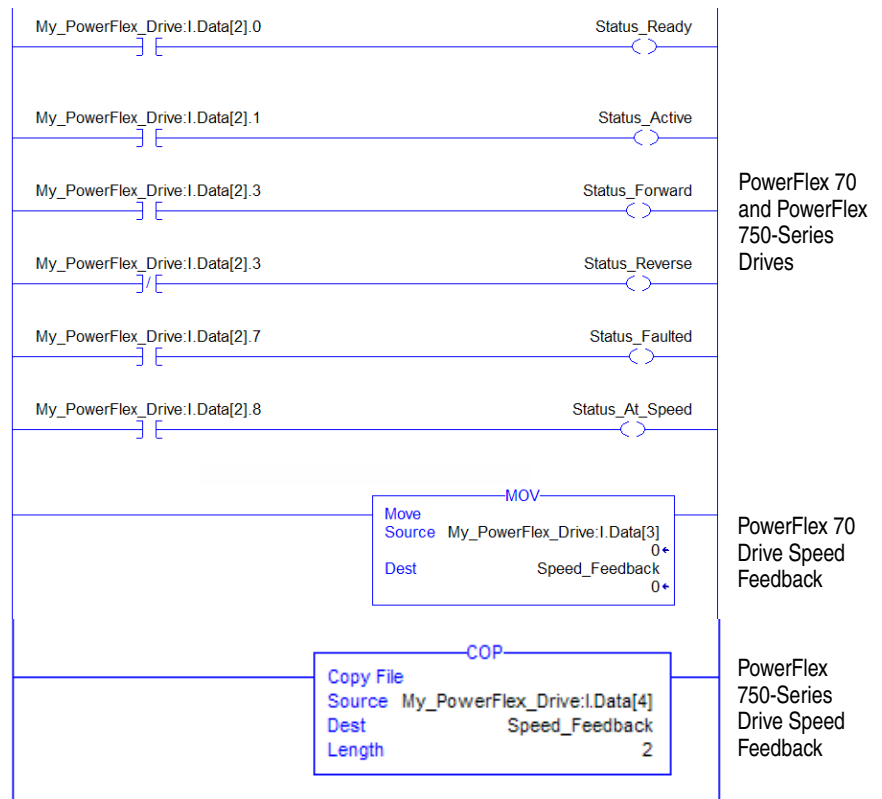

**Figure 5.9 ControlLogix Example Ladder Logic Program Using a Drive Generic Profile for Logic Command/Reference**

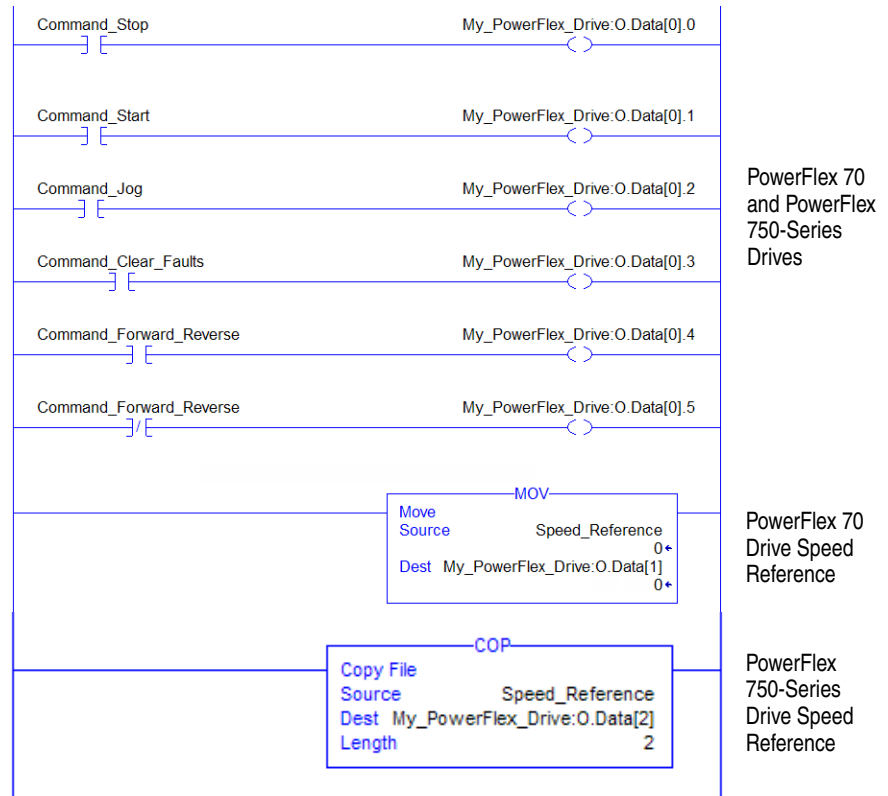

**Example Datalink Data**

The Datalink data used in the example program is shown in [Figure 5.10](#). Note that to describe the parameters to which the Datalinks are assigned, you may want to add descriptions to the automatically-created generic controller tags or create a User Defined Data Types (UDDT).

**Figure 5.10 ControlLogix Example Datalinks for Ladder Logic Program Using a Drive Generic Profile**

Name	Value	Data Type	Description
My_PowerFlex_Drive:I	{...}	AB:CONTR...	
My_PowerFlex_Drive:I.Data	{...}	INT[12]	Input Image
My_PowerFlex_Drive:I.Data[0]	0	INT	Pad Word
My_PowerFlex_Drive:I.Data[1]	0	INT	Pad Word
My_PowerFlex_Drive:I.Data[2]	0	INT	Logic Status
My_PowerFlex_Drive:I.Data[3]	0	INT	Speed Feedback
My_PowerFlex_Drive:I.Data[4]	50	INT	Datalink Out A1
My_PowerFlex_Drive:I.Data[5]	50	INT	Datalink Out A2
My_PowerFlex_Drive:I.Data[6]	100	INT	Datalink Out B1
My_PowerFlex_Drive:I.Data[7]	1	INT	Datalink Out B2
My_PowerFlex_Drive:I.Data[8]	200	INT	Datalink Out C1
My_PowerFlex_Drive:I.Data[9]	300	INT	Datalink Out C2
My_PowerFlex_Drive:I.Data[10]	400	INT	Datalink Out D1
My_PowerFlex_Drive:I.Data[11]	500	INT	Datalink Out D2
My_PowerFlex_Drive:O	{...}	AB:CONTR...	
My_PowerFlex_Drive:O.Data	{...}	INT[10]	Output Image
My_PowerFlex_Drive:O.Data[0]	0	INT	Logic Command
My_PowerFlex_Drive:O.Data[1]	0	INT	Speed Reference
My_PowerFlex_Drive:O.Data[2]	50	INT	Datalink In A1
My_PowerFlex_Drive:O.Data[3]	50	INT	Datalink In A2
My_PowerFlex_Drive:O.Data[4]	100	INT	Datalink In B1
My_PowerFlex_Drive:O.Data[5]	1	INT	Datalink In B2
My_PowerFlex_Drive:O.Data[6]	200	INT	Datalink In C1
My_PowerFlex_Drive:O.Data[7]	300	INT	Datalink In C2
My_PowerFlex_Drive:O.Data[8]	400	INT	Datalink In D1
My_PowerFlex_Drive:O.Data[9]	500	INT	Datalink In D2

PowerFlex 70 Drive

Name	Value	Data Type	Description
My_PowerFlex_Drive:I	{...}	AB:CONTR...	
My_PowerFlex_Drive:I.Data	{...}	INT[22]	Input Image
My_PowerFlex_Drive:I.Data[0]	0	INT	Pad Word
My_PowerFlex_Drive:I.Data[1]	0	INT	Pad Word
My_PowerFlex_Drive:I.Data[2]	1295	INT	Logic Status
My_PowerFlex_Drive:I.Data[3]	0	INT	Not Used
My_PowerFlex_Drive:I.Data[4]	25000	INT	Feedback (LSW)
My_PowerFlex_Drive:I.Data[5]	0	INT	Feedback (MSW)
My_PowerFlex_Drive:I.Data[6]	-26970	INT	Datalink Out A1 (LSW)
My_PowerFlex_Drive:I.Data[7]	17432	INT	Datalink Out A1 (MSW)
My_PowerFlex_Drive:I.Data[8]	15562	INT	Datalink Out A2 (LSW)
My_PowerFlex_Drive:I.Data[9]	5457	INT	Datalink Out A2 (MSW)
My_PowerFlex_Drive:I.Data[10]	0	INT	Datalink Out B1 (LSW)
My_PowerFlex_Drive:I.Data[11]	16840	INT	Datalink Out B1 (MSW)
My_PowerFlex_Drive:I.Data[12]	0	INT	Datalink Out B2 (LSW)
My_PowerFlex_Drive:I.Data[13]	0	INT	Datalink Out B2 (MSW)
My_PowerFlex_Drive:I.Data[14]	0	INT	Datalink Out C1 (LSW)
My_PowerFlex_Drive:I.Data[15]	0	INT	Datalink Out C1 (MSW)
My_PowerFlex_Drive:I.Data[16]	0	INT	Datalink Out C2 (LSW)
My_PowerFlex_Drive:I.Data[17]	0	INT	Datalink Out C2 (MSW)
My_PowerFlex_Drive:I.Data[18]	0	INT	Datalink Out D1 (LSW)
My_PowerFlex_Drive:I.Data[19]	0	INT	Datalink Out D1 (MSW)
My_PowerFlex_Drive:I.Data[20]	0	INT	Datalink Out D2 (LSW)
My_PowerFlex_Drive:I.Data[21]	0	INT	Datalink Out D2 (MSW)
My_PowerFlex_Drive:O	{...}	AB:CONTR...	
My_PowerFlex_Drive:O.Data	{...}	INT[20]	Output Image
My_PowerFlex_Drive:O.Data[0]	0	INT	Logic Command
My_PowerFlex_Drive:O.Data[1]	0	INT	Not Used
My_PowerFlex_Drive:O.Data[2]	25000	INT	Reference (LSW)
My_PowerFlex_Drive:O.Data[3]	0	INT	Reference (MSW)
My_PowerFlex_Drive:O.Data[4]	0	INT	Datalink In A1 (LSW)
My_PowerFlex_Drive:O.Data[5]	16680	INT	Datalink In A1 (MSW)
My_PowerFlex_Drive:O.Data[6]	4430	INT	Datalink In A2 (LSW)
My_PowerFlex_Drive:O.Data[7]	1909	INT	Datalink In A2 (MSW)
My_PowerFlex_Drive:O.Data[8]	-2621	INT	Datalink In B1 (LSW)
My_PowerFlex_Drive:O.Data[9]	16664	INT	Datalink In B1 (MSW)
My_PowerFlex_Drive:O.Data[10]	0	INT	Datalink In B2 (LSW)
My_PowerFlex_Drive:O.Data[11]	0	INT	Datalink In B2 (MSW)

PowerFlex 750-Series Drive

For PowerFlex 7-Class drives, the scaling may need to be multiplied by 10 or 100, depending on the parameter. For more information, see [Datalink Scaling on page 5-11](#).

► **TIP:** When using a drive that has 16-bit Datalinks (PowerFlex 70, PowerFlex 700, and PowerFlex 700H drives) to transfer a 32-bit parameter, two contiguous drive Datalink parameters (for example, Data Out A1/A2, B1/B2, and so forth) are required. To determine if a parameter is a 32-bit parameter, see the Parameter section in the drive documentation and look for a  $\nabla^{32}$  symbol in the ‘No.’ column. (All parameters in PowerFlex 700 Series B drives are 32-bit parameters.) For example, parameter 3 - [Output Current] in a PowerFlex 70 EC drive is a 32-bit parameter. When using a drive that has 32-bit Datalinks (PowerFlex 700 VC, PowerFlex 700S, and PowerFlex 750-Series drives), only one drive Datalink parameter is required to transfer any parameter.

**Figure 5.11 ControlLogix Example Ladder Logic Program Using a Drive Generic Profile for PowerFlex 750-Series Drives Datalink Scaling**

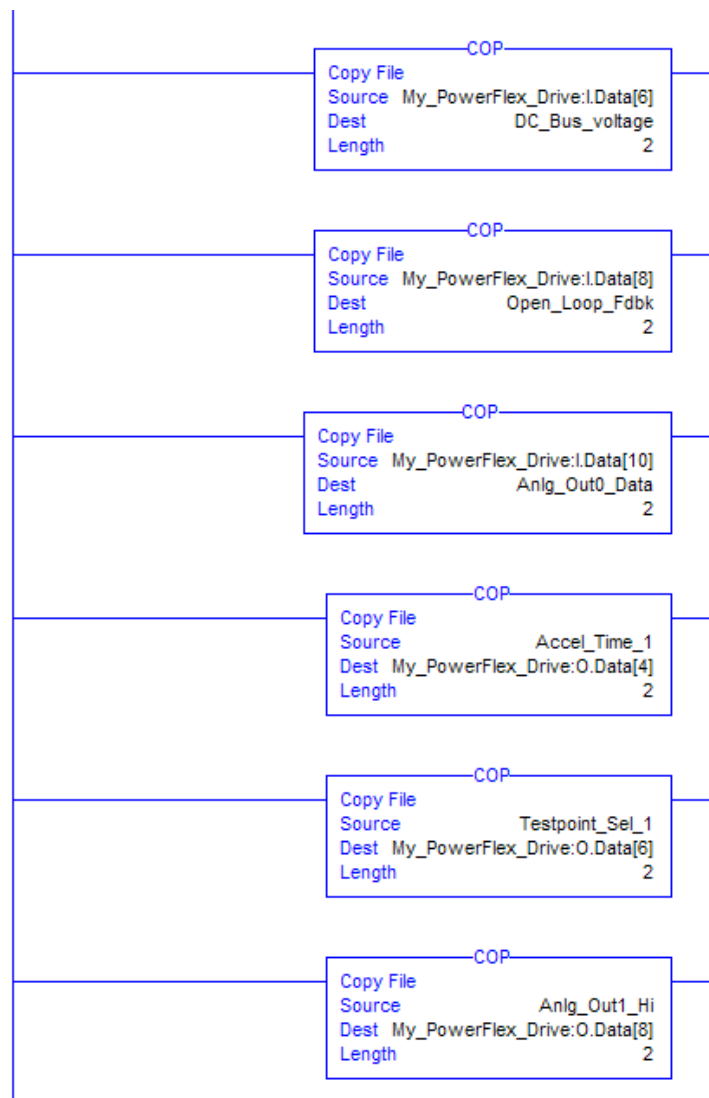

For PowerFlex 750-Series drives, the destination tag can be a REAL or DINT. Make the destination tag the same data type as the parameter being read. For information on Datalink scaling, see [page 5-12](#).



## PLC-5 Controller Example    Creating an RSLogix 5 Project, Version 7.00 or Later

To transmit (read and write) data between the controller and drive, you must create discrete I/O instructions in the controller for Logic Command/Status, Reference/Feedback, and Datalinks.

1. Start RSLogix 5 software.

The RSLogix 5 window appears.

2. Select **File > New** to display the Select Processor Type screen.

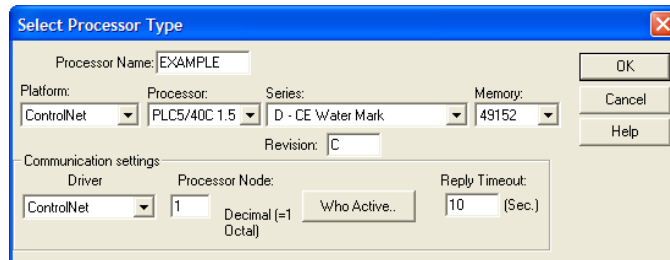

3. Assign a name for the processor.
4. From the pull-down menus, choose the appropriate choices to match your PLC-5 controller and application.
5. Click **OK**.

The Select ControlNet Project screen appears.

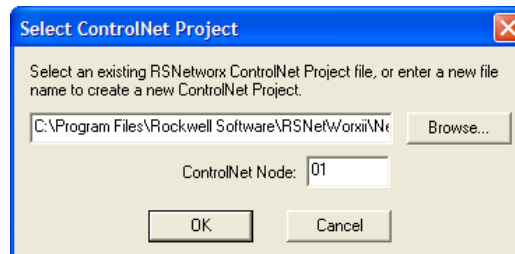

6. Click **Browse...** and choose the RSNetWorx for ControlNet project file created in [Chapter 4](#).
7. Enter the node address of the controller in the ControlNet Node field.
8. Click **OK**.

The RSLogix 5 project window appears.

## Drive and Adapter Parameter Settings

The following drive and adapter settings were used for the example ladder logic program in this section.

Device	Parameter	Value	Description
PowerFlex 70 EC Drive	90 - [Speed Ref A Sel]	22 (DPI Port 5)	Assigns 20-COMM-C/-Q to be used for the Reference.
	300 - [Data In A1]	140	Points to Par. 140 - [Accel Time 1]
	301 - [Data In A2]	142	Points to Par. 142 - [Decel Time 1]
	302 - [Data In B1]	100	Points to Par. 100 - [Jog Speed]
	303 - [Data In B2]	155	Points to Par. 155 - [Stop Mode A]
	304 - [Data In C1]	101	Points to Par. 101 - [Preset Speed 1]
	305 - [Data In C2]	102	Points to Par. 102 - [Preset Speed 2]
	306 - [Data In D1]	103	Points to Par. 103 - [Preset Speed 3]
	307 - [Data In D2]	104	Points to Par. 104 - [Preset Speed 4]
	310 - [Data Out A1]	140	Points to Par. 140 - [Accel Time 1]
	311 - [Data Out A2]	142	Points to Par. 142 - [Decel Time 1]
	312 - [Data Out B1]	100	Points to Par. 100 - [Jog Speed]
	313 - [Data Out B2]	155	Points to Par. 155 - [Stop Mode A]
	314 - [Data Out C1]	101	Points to Par. 101 - [Preset Speed 1]
	315 - [Data Out C2]	102	Points to Par. 102 - [Preset Speed 2]
	316 - [Data Out D1]	103	Points to Par. 103 - [Preset Speed 3]
	317 - [Data Out D2]	104	Points to Par. 104 - [Preset Speed 4]
PowerFlex 750-Series Drive <sup>(1)</sup>	545 - [Spd Ref A Sel]	Port 0: Port 6 Reference	Assigns 20-COMM-C/Q to be used for the Reference.
	895 - [Data In A1]	Port 0: Accel Time 1	Points to Par. 535 in the drive.
	896 - [Data In A2]	Port 0: Testpoint Sel 1	Points to Par. 970 in the drive.
	897 - [Data In B1]	Port 5: Anlg Out1 Hi	Points to Par. 90 in Port 5 (I/O module).
	905 - [Data Out A1]	Port 0: DC Bus Volts	Points to Par. 11 in the drive.
	906 - [Data Out A2]	Port 0: Open Loop Fdbk	Points to Par. 137 in the drive.
	907 - [Data Out B1]	Port 5: Anlg Out0 Data	Points to Par. 77 in Port 5 (I/O module).
20-COMM-C or 20-COMM-Q Adapter	03 - [CN Addr Cfg]	2	Node address for the adapter.
	13 - [DPI I/O Cfg]	xxx1 1111	Enables Cmd/Ref and Datalinks A...D.
	25 - [M-S Input]	xxx1 1111	Configures the I/O Data to be transferred from the controller on the network to the drive.
	26 - [M-S Output]	xxx1 1111	Configures the I/O Data to be transferred from the drive to the controller on the network.

<sup>(1)</sup> In this example, the 20-COMM-C or 20-COMM-Q adapter/20-750-20COMM Communication Carrier Card is installed in Port 6, and a 24V I/O module is installed in Port 5. Also, Data In B2...D2 (Parameters 898...902) and Data Out B2...D2 (Parameters 908...912) are enabled, but not used.



**TIP:** Data In parameters are inputs into the drive that come from controller outputs (for example, data to write to a drive parameter). Data Out parameters are outputs from the drive that go to controller inputs (for example, data to read a drive parameter).

► **TIP:** When using a drive that has 16-bit Datalinks (PowerFlex 70, PowerFlex 700, and PowerFlex 700H drives) to transfer a 32-bit parameter, two contiguous drive Datalink parameters (for example, Data Out A1/A2, B1/B2, and so forth) are required. To determine if a parameter is a 32-bit parameter, see the Parameter section in the drive documentation and look for a  $\nabla^{32}$  symbol in the ‘No.’ column. (All parameters in PowerFlex 700 Series B drives are 32-bit parameters.) For example, parameter 3 - [Output Current] in a PowerFlex 70 EC drive is a 32-bit parameter. When using a drive that has 32-bit Datalinks (PowerFlex 700 VC, PowerFlex 700S, and PowerFlex 750-Series drives), only one drive Datalink parameter is required to transfer any parameter.

## Understanding PLC-5 Controller Data Table Addresses

Because the PLC-5 controller is a 16-bit platform and is used with the 32-bit 20-COMM-C or 20-COMM-Q adapter, the data will be transposed from the least-significant word (LSW) to the most-significant word (MSW) in the controller.

When the I/O was configured ([Chapter 4](#)), two available data table addresses (N9:0 for input data and N10:0 for output data) were used. [Figure 5.12](#) shows the data file address structure for this example.

**Figure 5.12 Data File Table for Example Ladder Logic Program**

The figure shows two overlapping windows from the ControlNet data file editor. The top window is titled 'File N9 (dec) -- CNET\_DATA -- ControlNet data file' and displays a table with 10 columns (Offset 0-9) and 2 rows (N9:0, N9:10). The N9:0 row has values 3596, 0, 0, 0, 3241, 85, 0, 0, 0, 0. The N9:10 row has all zeros. Below the table are fields for Symbol (N9:0), Radix (Decimal), and Columns (10). The bottom window is titled 'File N10 (dec) -- CNET\_DATA -- ControlNet data file' and displays a table with 10 columns (Offset 0-9) and 2 rows (N10:0, N10:10). The N10:0 row has values 0, 0, 0, 0, 0, 0, 0, 0, 0, 0. The N10:10 row has all zeros. Below the table are fields for Symbol (N10:0), Radix (Decimal), and Columns (10). Buttons for Properties, Usage, and Help are visible at the bottom.

Offset	0	1	2	3	4	5	6	7	8	9
N9:0	3596	0	0	0	3241	85	0	0	0	0
N9:10	0	0	0	0	0	0	0	0	0	0

Offset	0	1	2	3	4	5	6	7	8	9
N10:0	0	0	0	0	0	0	0	0	0	0
N10:10	0	0	0	0	0	0	0	0	0	0

Depending on the drive, [Table 5.J](#), [Table 5.K](#), [Table 5.L](#), [Table 5.M](#), [Table 5.N](#), or [Table 5.O](#) show the I/O definitions as they relate to the N9:0 and N10:0 data table addresses in [Figure 5.12](#) being used in this example.

PowerFlex 70, PowerFlex 700 with Standard Control, and PowerFlex 700H Drives

When using any of these products—which all contain INT (16-bit format) data types—you will read from and write to a single data table address in the controller.

**Table 5.J PLC-5 Data Table Addresses for:**  
**PowerFlex 70 Drives with Standard or Enhanced Control**  
**PowerFlex 700 Drives with Standard Control**  
**PowerFlex 700H Drives**

Data Table Address	Description
N9:0	Logic Status (see <a href="#">Appendix D</a> )
N9:1	Speed Feedback
N9:2	Value of parameter assigned to Parameter 310 [Data Out A1]
N9:3	Value of parameter assigned to Parameter 311 [Data Out A2]
N9:4	Value of parameter assigned to Parameter 312 [Data Out B1]
N9:5	Value of parameter assigned to Parameter 313 [Data Out B2]
N9:6	Value of parameter assigned to Parameter 314 [Data Out C1]
N9:7	Value of parameter assigned to Parameter 315 [Data Out C2]
N9:8	Value of parameter assigned to Parameter 316 [Data Out D1]
N9:9	Value of parameter assigned to Parameter 317 [Data Out D2]
N10:0	Logic Command (see <a href="#">Appendix D</a> )
N10:1	Speed Reference
N10:2	Value of parameter assigned to Parameter 300 [Data In A1]
N10:3	Value of parameter assigned to Parameter 301 [Data In A2]
N10:4	Value of parameter assigned to Parameter 302 [Data In B1]
N10:5	Value of parameter assigned to Parameter 303 [Data In B2]
N10:6	Value of parameter assigned to Parameter 304 [Data In C1]
N10:7	Value of parameter assigned to Parameter 305 [Data In C2]
N10:8	Value of parameter assigned to Parameter 306 [Data In D1]
N10:9	Value of parameter assigned to Parameter 307 [Data In D2]

## PowerFlex 700 Drives with Vector Control and PowerFlex 700L Drives with 700 Control

When using these drives, which contain DINT (32-bit format) data types, you will read from and write to the LSW data table address in the controller.

**Table 5.K PLC-5 Data Table Addresses for:  
PowerFlex 700 Drives with Vector Control  
PowerFlex 700L Drives with 700 Control**

Data Table Address	Description
N9:0	Logic Status (see <a href="#">Appendix D</a> )
N9:1	Speed Feedback
N9:2	Value of parameter assigned to Parameter 310 [Data Out A1] LSW
N9:3	Value of parameter assigned to Parameter 310 [Data Out A1] MSW
N9:4	Value of parameter assigned to Parameter 311 [Data Out A2] LSW
N9:5	Value of parameter assigned to Parameter 311 [Data Out A2] MSW
N9:6	Value of parameter assigned to Parameter 312 [Data Out B1] LSW
N9:7	Value of parameter assigned to Parameter 312 [Data Out B1] MSW
N9:8	Value of parameter assigned to Parameter 313 [Data Out B2] LSW
N9:9	Value of parameter assigned to Parameter 313 [Data Out B2] MSW
N9:10	Value of parameter assigned to Parameter 314 [Data Out C1] LSW
N9:11	Value of parameter assigned to Parameter 314 [Data Out C1] MSW
N9:12	Value of parameter assigned to Parameter 315 [Data Out C2] LSW
N9:13	Value of parameter assigned to Parameter 315 [Data Out C2] MSW
N9:14	Value of parameter assigned to Parameter 316 [Data Out D1] LSW
N9:15	Value of parameter assigned to Parameter 316 [Data Out D1] MSW
N9:16	Value of parameter assigned to Parameter 317 [Data Out D2] LSW
N9:17	Value of parameter assigned to Parameter 317 [Data Out D2] MSW
N10:0	Logic Command (see <a href="#">Appendix D</a> )
N10:1	Speed Reference
N10:2	Value of parameter assigned to Parameter 300 [Data In A1] LSW
N10:3	Value of parameter assigned to Parameter 300 [Data In A1] MSW
N10:4	Value of parameter assigned to Parameter 301 [Data In A2] LSW
N10:5	Value of parameter assigned to Parameter 301 [Data In A2] MSW
N10:6	Value of parameter assigned to Parameter 302 [Data In B1] LSW
N10:7	Value of parameter assigned to Parameter 302 [Data In B1] MSW
N10:8	Value of parameter assigned to Parameter 303 [Data In B2] LSW
N10:9	Value of parameter assigned to Parameter 303 [Data In B2] MSW
N10:10	Value of parameter assigned to Parameter 304 [Data In C1] LSW
N10:11	Value of parameter assigned to Parameter 304 [Data In C1] MSW
N10:12	Value of parameter assigned to Parameter 305 [Data In C2] LSW
N10:13	Value of parameter assigned to Parameter 305 [Data In C2] MSW
N10:14	Value of parameter assigned to Parameter 306 [Data In D1] LSW
N10:15	Value of parameter assigned to Parameter 306 [Data In D1] MSW
N10:16	Value of parameter assigned to Parameter 307 [Data In D2] LSW
N10:17	Value of parameter assigned to Parameter 307 [Data In D2] MSW

PowerFlex 700S, PowerFlex 700L with 700S Control, PowerFlex 750-Series, and PowerFlex Digital DC Drives

When using any of these drives, which contain both DINT (32-bit format) and REAL (floating point format) data types, you will always read from and write to the LSW data table address in the controller first. Then if the data value exceeds 16 bits, the remaining value will be in the MSW data table address.

**Table 5.L PLC-5 Data Table Addresses for PowerFlex 700S Drives (Phase I Control)**

Data Table Address	Description
N9:0	Logic Status (see <a href="#">Appendix D</a> )
N9:1	Not Used
N9:2	Speed Feedback LSW
N9:3	Speed Feedback MSW
N9:4	Value of parameter assigned to Parameter 724/725 [Data Out A1] LSW
N9:5	Value of parameter assigned to Parameter 724/725 [Data Out A1] MSW
N9:6	Value of parameter assigned to Parameter 726/727 [Data Out A2] LSW
N9:7	Value of parameter assigned to Parameter 726/727 [Data Out A2] MSW
N9:8	Value of parameter assigned to Parameter 728/729 [Data Out B1] LSW
N9:9	Value of parameter assigned to Parameter 728/729 [Data Out B1] MSW
N9:10	Value of parameter assigned to Parameter 730/731 [Data Out B2] LSW
N9:11	Value of parameter assigned to Parameter 730/731 [Data Out B2] MSW
N9:12	Value of parameter assigned to Parameter 732/733 [Data Out C1] LSW
N9:13	Value of parameter assigned to Parameter 732/733 [Data Out C1] MSW
N9:14	Value of parameter assigned to Parameter 734/735 [Data Out C2] LSW
N9:15	Value of parameter assigned to Parameter 734/735 [Data Out C2] MSW
N9:16	Value of parameter assigned to Parameter 736/737 [Data Out D1] LSW
N9:17	Value of parameter assigned to Parameter 736/737 [Data Out D1] MSW
N9:18	Value of parameter assigned to Parameter 738/739 [Data Out D2] LSW
N9:19	Value of parameter assigned to Parameter 738/739 [Data Out D2] MSW
N10:0	Logic Command (see <a href="#">Appendix D</a> )
N10:1	Not Used
N10:2	Speed Reference LSW
N10:3	Speed Reference MSW
N10:4	Value of parameter assigned to Parameter 707/708 [Data In A1] LSW
N10:5	Value of parameter assigned to Parameter 707/708 [Data In A1] MSW
N10:6	Value of parameter assigned to Parameter 709/710 [Data In A2] LSW
N10:7	Value of parameter assigned to Parameter 709/710 [Data In A2] MSW
N10:8	Value of parameter assigned to Parameter 711/712 [Data In B1] LSW
N10:9	Value of parameter assigned to Parameter 711/712 [Data In B1] MSW
N10:10	Value of parameter assigned to Parameter 713/714 [Data In B2] LSW
N10:11	Value of parameter assigned to Parameter 713/714 [Data In B2] MSW
N10:12	Value of parameter assigned to Parameter 715/716 [Data In C1] LSW
N10:13	Value of parameter assigned to Parameter 715/716 [Data In C1] MSW
N10:14	Value of parameter assigned to Parameter 717/718 [Data In C2] LSW
N10:15	Value of parameter assigned to Parameter 717/718 [Data In C2] MSW
N10:16	Value of parameter assigned to Parameter 719/720 [Data In D1] LSW
N10:17	Value of parameter assigned to Parameter 719/720 [Data In D1] MSW
N10:18	Value of parameter assigned to Parameter 721/722 [Data In D2] LSW
N10:19	Value of parameter assigned to Parameter 721/722 [Data In D2] MSW

**Table 5.M PLC-5 Data Table Addresses for:  
PowerFlex 700S Drives with Phase II Control  
PowerFlex 700L Drives with 700S Control**

Data Table Address	Description
N9:0	Logic Status (see <a href="#">Appendix D</a> )
N9:1	Not Used
N9:2	Speed Feedback LSW
N9:3	Speed Feedback MSW
N9:4	Value of parameter assigned to Parameter 660 [DPI Data Out A1] LSW
N9:5	Value of parameter assigned to Parameter 660 [DPI Data Out A1] MSW
N9:6	Value of parameter assigned to Parameter 661 [DPI Data Out A2] LSW
N9:7	Value of parameter assigned to Parameter 661 [DPI Data Out A2] MSW
N9:8	Value of parameter assigned to Parameter 662 [DPI Data Out B1] LSW
N9:9	Value of parameter assigned to Parameter 662 [DPI Data Out B1] MSW
N9:10	Value of parameter assigned to Parameter 663 [DPI Data Out B2] LSW
N9:11	Value of parameter assigned to Parameter 663 [DPI Data Out B2] MSW
N9:12	Value of parameter assigned to Parameter 664 [DPI Data Out C1] LSW
N9:13	Value of parameter assigned to Parameter 664 [DPI Data Out C1] MSW
N9:14	Value of parameter assigned to Parameter 665 [DPI Data Out C2] LSW
N9:15	Value of parameter assigned to Parameter 665 [DPI Data Out C2] MSW
N9:16	Value of parameter assigned to Parameter 666 [DPI Data Out D1] LSW
N9:17	Value of parameter assigned to Parameter 666 [DPI Data Out D1] MSW
N9:18	Value of parameter assigned to Parameter 667 [DPI Data Out D2] LSW
N9:19	Value of parameter assigned to Parameter 667 [DPI Data Out D2] MSW
N10:0	Logic Command (see <a href="#">Appendix D</a> )
N10:1	Not Used
N10:2	Speed Reference LSW
N10:3	Speed Reference MSW
N10:4	Value of parameter assigned to Parameter 651 [DPI Data In A1] LSW
N10:5	Value of parameter assigned to Parameter 651 [DPI Data In A1] MSW
N10:6	Value of parameter assigned to Parameter 652 [DPI Data In A2] LSW
N10:7	Value of parameter assigned to Parameter 652 [DPI Data In A2] MSW
N10:8	Value of parameter assigned to Parameter 653 [DPI Data In B1] LSW
N10:9	Value of parameter assigned to Parameter 653 [DPI Data In B1] MSW
N10:10	Value of parameter assigned to Parameter 654 [DPI Data In B2] LSW
N10:11	Value of parameter assigned to Parameter 654 [DPI Data In B2] MSW
N10:12	Value of parameter assigned to Parameter 655 [DPI Data In C1] LSW
N10:13	Value of parameter assigned to Parameter 655 [DPI Data In C1] MSW
N10:14	Value of parameter assigned to Parameter 656 [DPI Data In C2] LSW
N10:15	Value of parameter assigned to Parameter 656 [DPI Data In C2] MSW
N10:16	Value of parameter assigned to Parameter 657 [DPI Data In D1] LSW
N10:17	Value of parameter assigned to Parameter 657 [DPI Data In D1] MSW
N10:18	Value of parameter assigned to Parameter 658 [DPI Data In D2] LSW
N10:19	Value of parameter assigned to Parameter 658 [DPI Data In D2] MSW

**Table 5.N PLC-5 Data Table Addresses for PowerFlex 750-Series Drives**

<b>Data Table Address</b>	<b>Description</b>
N9:0	Logic Status (see <a href="#">Appendix D</a> )
N9:1	Not Used
N9:2	Speed Feedback LSW
N9:3	Speed Feedback MSW
N9:4	Value of parameter assigned to Parameter 905 [Data Out A1] LSW
N9:5	Value of parameter assigned to Parameter 905 [Data Out A1] MSW
N9:6	Value of parameter assigned to Parameter 906 [Data Out A2] LSW
N9:7	Value of parameter assigned to Parameter 906 [Data Out A2] MSW
N9:8	Value of parameter assigned to Parameter 907 [Data Out B1] LSW
N9:9	Value of parameter assigned to Parameter 907 [Data Out B1] MSW
N9:10	Value of parameter assigned to Parameter 908 [Data Out B2] LSW
N9:11	Value of parameter assigned to Parameter 908 [Data Out B2] MSW
N9:12	Value of parameter assigned to Parameter 909 [Data Out C1] LSW
N9:13	Value of parameter assigned to Parameter 909 [Data Out C1] MSW
N9:14	Value of parameter assigned to Parameter 910 [Data Out C2] LSW
N9:15	Value of parameter assigned to Parameter 910 [Data Out C2] MSW
N9:16	Value of parameter assigned to Parameter 911 [Data Out D1] LSW
N9:17	Value of parameter assigned to Parameter 911 [Data Out D1] MSW
N9:18	Value of parameter assigned to Parameter 912 [Data Out D2] LSW
N9:19	Value of parameter assigned to Parameter 912 [Data Out D2] MSW
N10:0	Logic Command (see <a href="#">Appendix D</a> )
N10:1	Not Used
N10:2	Speed Reference LSW
N10:3	Speed Reference MSW
N10:4	Value of parameter assigned to Parameter 895 [Data In A1] LSW
N10:5	Value of parameter assigned to Parameter 895 [Data In A1] MSW
N10:6	Value of parameter assigned to Parameter 896 [Data In A2] LSW
N10:7	Value of parameter assigned to Parameter 896 [Data In A2] MSW
N10:8	Value of parameter assigned to Parameter 897 [Data In B1] LSW
N10:9	Value of parameter assigned to Parameter 897 [Data In B1] MSW
N10:10	Value of parameter assigned to Parameter 898 [Data In B2] LSW
N10:11	Value of parameter assigned to Parameter 898 [Data In B2] MSW
N10:12	Value of parameter assigned to Parameter 899 [Data In C1] LSW
N10:13	Value of parameter assigned to Parameter 899 [Data In C1] MSW
N10:14	Value of parameter assigned to Parameter 900 [Data In C2] LSW
N10:15	Value of parameter assigned to Parameter 900 [Data In C2] MSW
N10:16	Value of parameter assigned to Parameter 901 [Data In D1] LSW
N10:17	Value of parameter assigned to Parameter 901 [Data In D1] MSW
N10:18	Value of parameter assigned to Parameter 902 [Data In D2] LSW
N10:19	Value of parameter assigned to Parameter 902 [Data In D2] MSW



**Table 5.O PLC-5 Data Table Addresses for PowerFlex Digital DC Drives**

Data Table Address	Description
N9:0	Logic Status (see <a href="#">Appendix D</a> )
N9:1	Speed Feedback
N9:2	Value of parameter assigned to Parameter 618 [Data Out A1] LSW
N9:3	Value of parameter assigned to Parameter 618 [Data Out A1] MSW
N9:4	Value of parameter assigned to Parameter 619 [Data Out A2] LSW
N9:5	Value of parameter assigned to Parameter 619 [Data Out A2] MSW
N9:6	Value of parameter assigned to Parameter 620 [Data Out B1] LSW
N9:7	Value of parameter assigned to Parameter 620 [Data Out B1] MSW
N9:8	Value of parameter assigned to Parameter 621 [Data Out B2] LSW
N9:9	Value of parameter assigned to Parameter 621 [Data Out B2] MSW
N9:10	Value of parameter assigned to Parameter 622 [Data Out C1] LSW
N9:11	Value of parameter assigned to Parameter 622 [Data Out C1] MSW
N9:12	Value of parameter assigned to Parameter 623 [Data Out C2] LSW
N9:13	Value of parameter assigned to Parameter 623 [Data Out C2] MSW
N9:14	Value of parameter assigned to Parameter 624 [Data Out D1] LSW
N9:15	Value of parameter assigned to Parameter 624 [Data Out D1] MSW
N9:16	Value of parameter assigned to Parameter 625 [Data Out D2] LSW
N9:17	Value of parameter assigned to Parameter 625 [Data Out D2] MSW
N10:0	Logic Command (see <a href="#">Appendix D</a> )
N10:1	Speed Reference
N10:2	Value of parameter assigned to Parameter 610 [Data In A1] LSW
N10:3	Value of parameter assigned to Parameter 610 [Data In A1] MSW
N10:4	Value of parameter assigned to Parameter 611 [Data In A2] LSW
N10:5	Value of parameter assigned to Parameter 611 [Data In A2] MSW
N10:6	Value of parameter assigned to Parameter 612 [Data In B1] LSW
N10:7	Value of parameter assigned to Parameter 612 [Data In B1] MSW
N10:8	Value of parameter assigned to Parameter 613 [Data In B2] LSW
N10:9	Value of parameter assigned to Parameter 613 [Data In B2] MSW
N10:10	Value of parameter assigned to Parameter 614 [Data In C1] LSW
N10:11	Value of parameter assigned to Parameter 614 [Data In C1] MSW
N10:12	Value of parameter assigned to Parameter 615 [Data In C2] LSW
N10:13	Value of parameter assigned to Parameter 615 [Data In C2] MSW
N10:14	Value of parameter assigned to Parameter 616 [Data In D1] LSW
N10:15	Value of parameter assigned to Parameter 616 [Data In D1] MSW
N10:16	Value of parameter assigned to Parameter 617 [Data In D2] LSW
N10:17	Value of parameter assigned to Parameter 617 [Data In D2] MSW

With any drive, you can use the controller data table addresses to directly control and monitor the drive without creating any ladder logic program. However, if you intend to use Human Machine Interface devices (PanelView, and so forth) to operate the drive and view its status, you will need to create descriptive controller data table addresses ([Table 5.P](#) and [Table 5.Q](#)) and a ladder logic program that will pass that data to the data table addresses used for messaging.

**Table 5.P PLC-5 and Program Data Table Address Descriptions for Example Logic Status/Feedback Ladder Logic Program**

Description	PLC-5 Data Table Address	Description	Program Data Table Address
Drive Ready	N9:0/0	Status Ready	B3:1/0
Drive Active	N9:0/1	Status Active	B3:1/1
Actual Direction (XIO)	N9:0/3	Status Forward	B3:1/3
Actual Direction (XIC)	N9:0/3	Status Reverse	B3:1/4
Drive Faulted	N9:0/7	Status Faulted	B3:1/7
Drive At Speed	N9:0/8	Status At Speed	B3:1/8
Speed Feedback (PowerFlex 70) (PowerFlex 753/755)	N9:1 N9:2	Speed Feedback (PowerFlex 70) (PowerFlex 753/755)	N20:1 F8:1

**Table 5.Q Program and PLC-5 Data Table Address Descriptions for Example Logic Command/Reference Ladder Logic Program**

Description	Program Data Table Address	Description	PLC-5 Data Table Address
Command Stop	B3:20/0	Drive Stop	N10:0/0
Command Start	B3:20/1	Drive Start	N10:0/1
Command Jog	B3:20/2	Drive Jog	N10:0/2
Command Clear Faults	B3:20/3	Drive Clear Faults	N10:0/3
Command Forward Reverse (XIO)	B3:20/4	Drive Forward	N10:0/4
Command Forward Reverse (XIC)	B3:20/4	Drive Reverse	N10:0/5
Speed Reference (PowerFlex 70) (PowerFlex 753/755)	N30:1 F8:3	Speed Reference (PowerFlex 70) (PowerFlex 753/755)	N10:1 N10:2

An example ladder logic program that uses these descriptive controller data table addresses and passes their data to the descriptive program data table addresses is shown in [Figure 5.13](#), [Figure 5.14](#), [Figure 5.15](#), and [Figure 5.16](#).

Figure 5.13 PLC-5 Example Ladder Logic Program for Logic Status

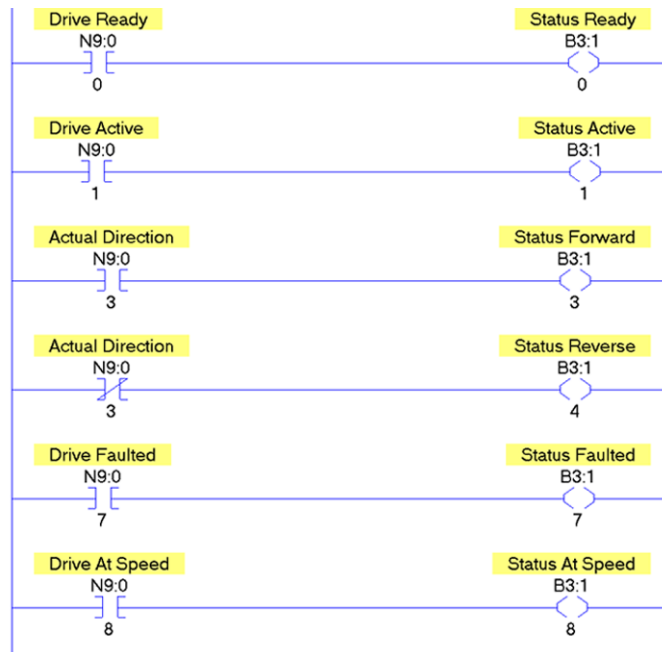

PowerFlex 70  
and PowerFlex  
750-Series  
Drives

Figure 5.14 PLC-5 Example Ladder Logic Program for Speed Feedback

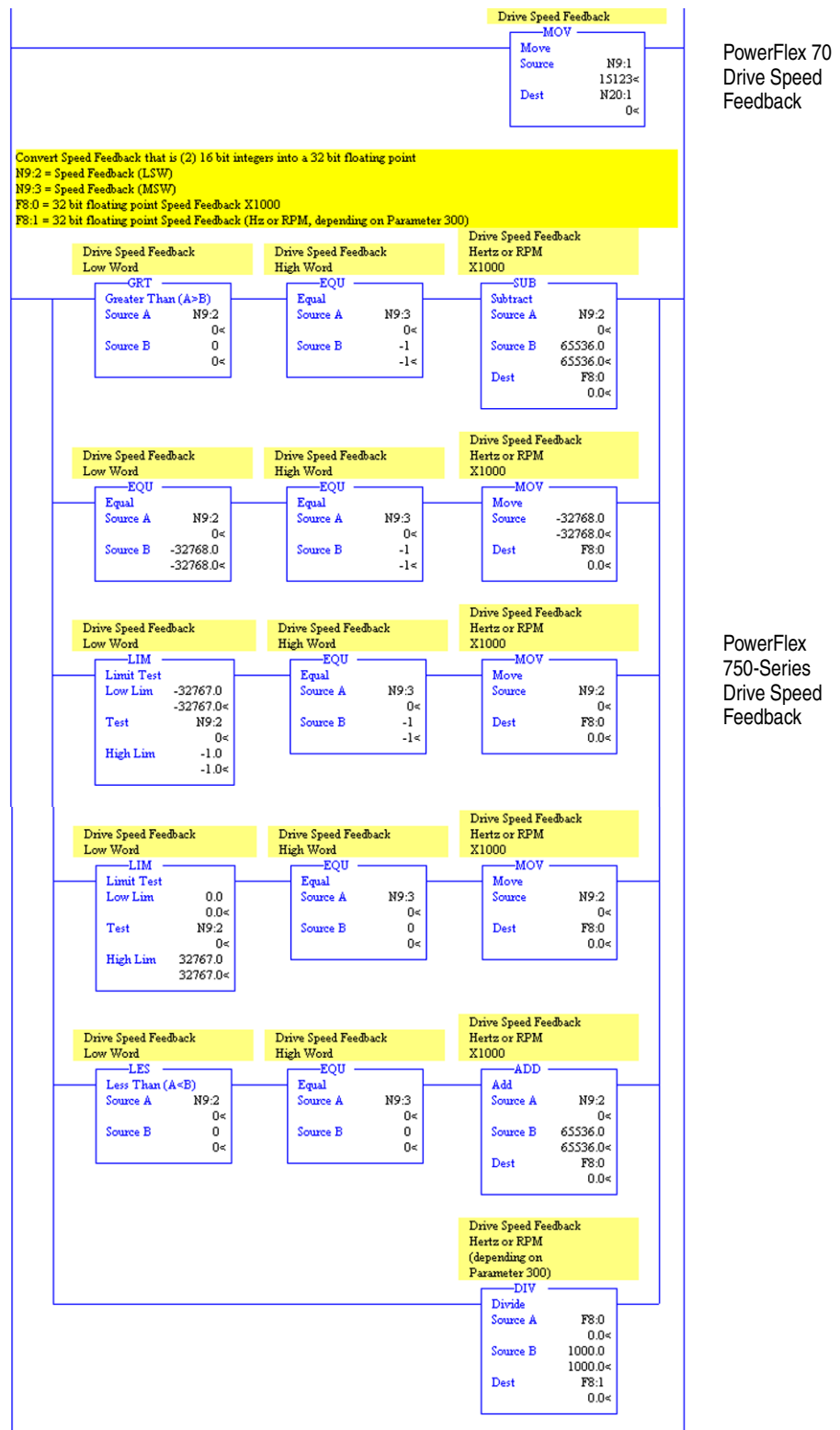

Depending on the drive being used, see one of the following subsections for information on speed Reference and Feedback scaling.

Subsection	Page
<a href="#">PowerFlex 70/700/700H and PowerFlex 700L Drives with 700 Control</a>	<a href="#">5-9</a>
<a href="#">PowerFlex 700S and PowerFlex 700L Drives with 700S Control</a>	<a href="#">5-10</a>
<a href="#">PowerFlex 753/755 Drives</a>	<a href="#">5-10</a>
<a href="#">PowerFlex Digital DC Drives</a>	<a href="#">5-11</a>

Figure 5.15 PLC-5 Example Ladder Logic Program for Logic Command

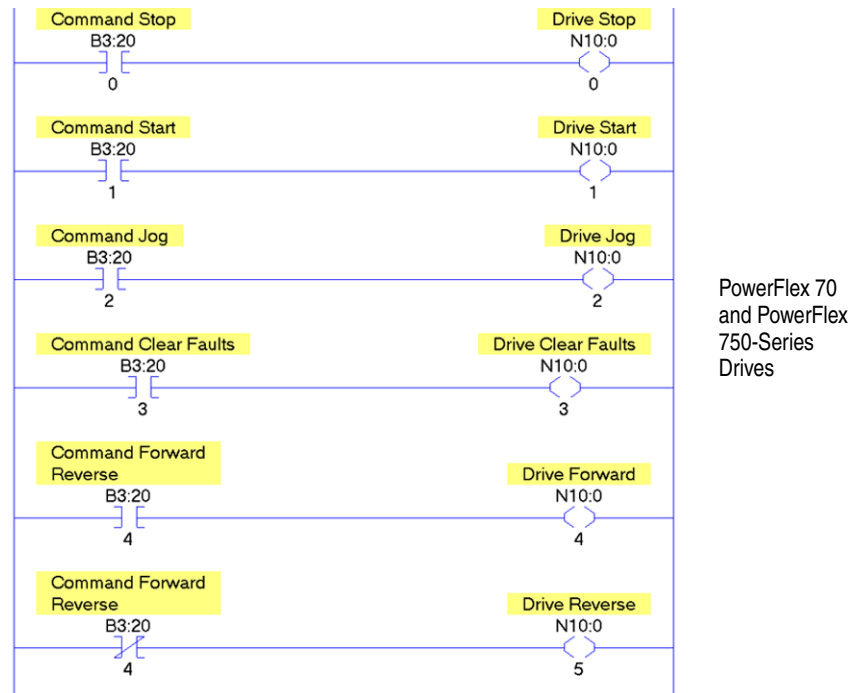
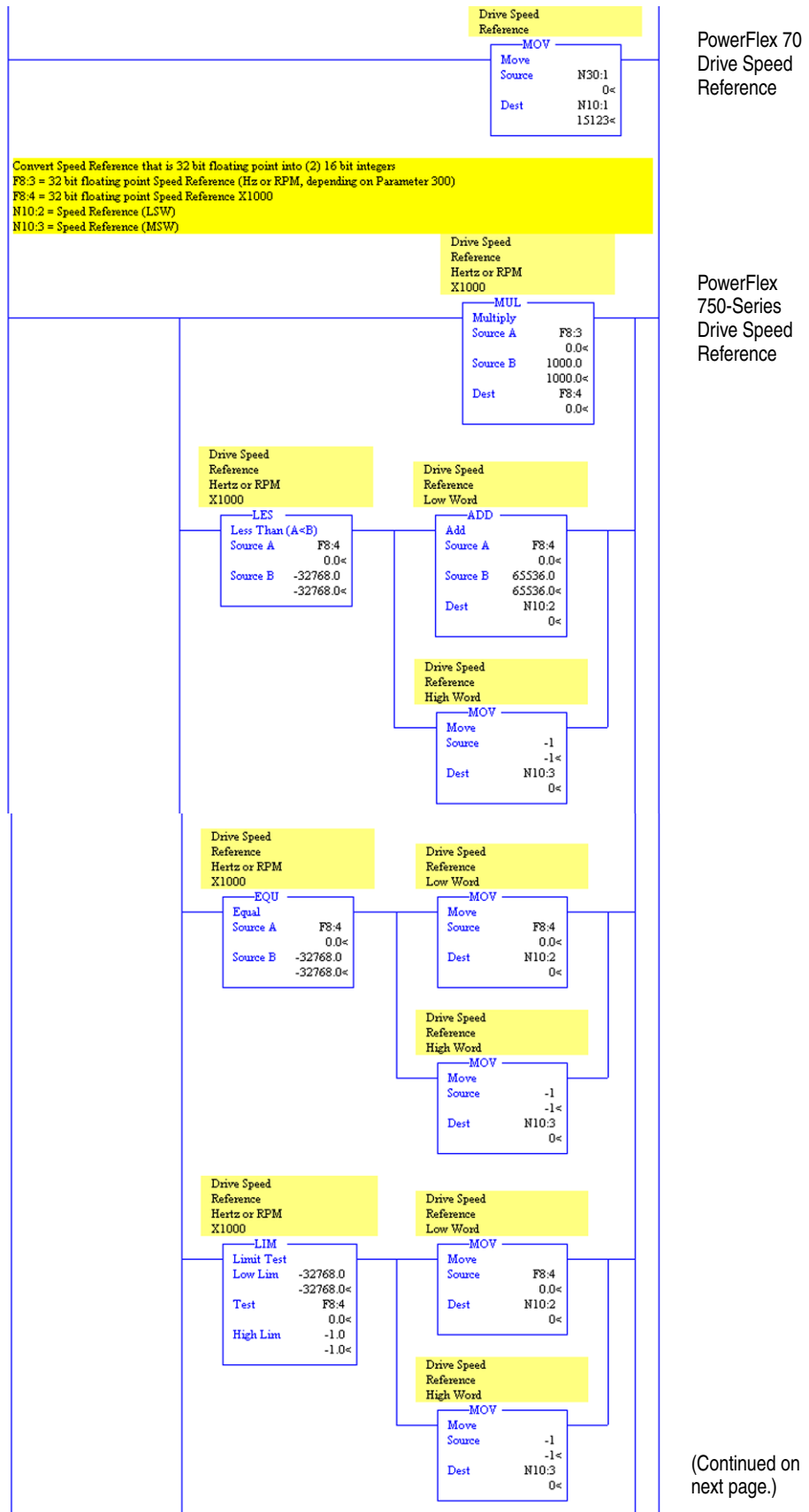
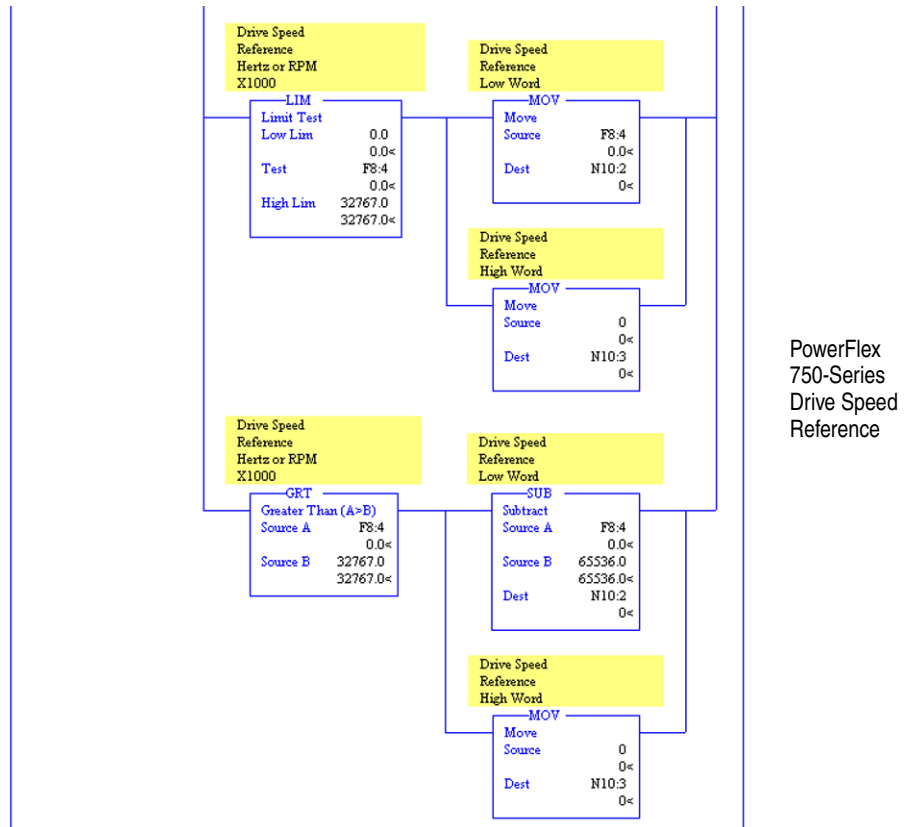

Figure 5.16 PLC-5 Example Ladder Logic Program for Speed Reference



(Continued on next page.)

(Continued from previous page.)



PowerFlex  
750-Series  
Drive Speed  
Reference

## SLC 500 Controller Example Creating an RSLogix 500 Project, Version 7.00 or Later

To transmit (read and write) data between the controller and drive, you must create discrete I/O instructions in the controller for Logic Command/Status, Reference/Feedback, and Datalinks. Also, COP instructions must be included in the ladder logic program to convert the default memory addresses in [Configuring the I/O](#) (Chapter 4) to data table addresses.

1. Start RSLogix 500 software.

The RSLogix 500 window appears.

2. Select **File > New** to display the Select Processor Type screen.

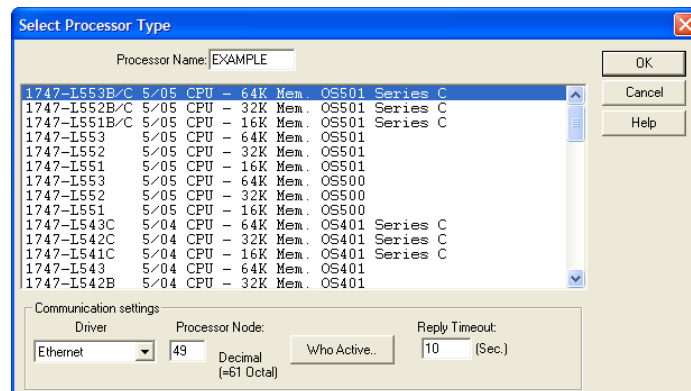

3. Assign a name for the processor.
4. In the list, select the appropriate processor (for this example, 1747-L552C 5/05).
5. Choose the appropriate choices for the fields in the screen to match your application.
6. Click **OK**.

The RSLogix 500 project window reappears.



7. In the project treeview, right-click IO Configuration and choose **Open** to display the I/O Configuration screen.

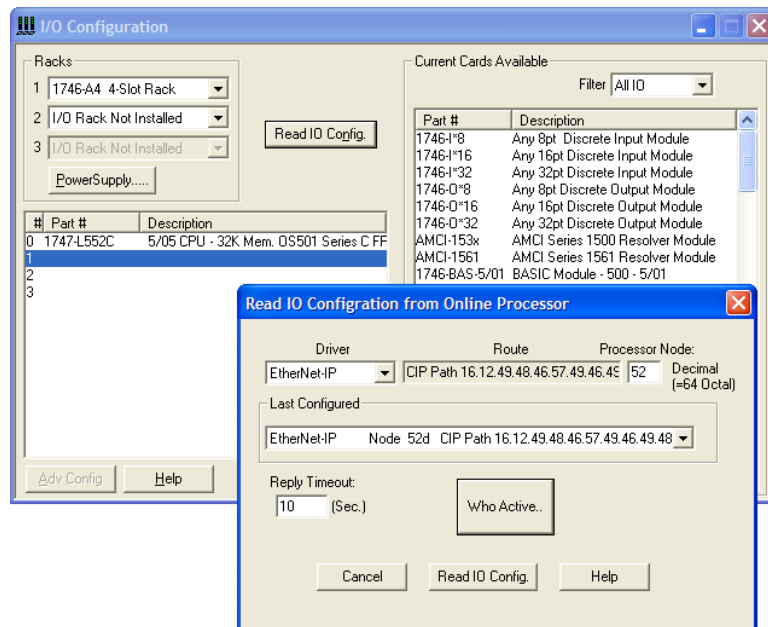

8. On the I/O Configuration screen, click **Read IO Config.** to display the Read IO Configuration from Online Processor screen.
  - a. Click **Who Active** and select the communication path to the processor.
  - b. Click **OK**.
  - c. Click **Read IO Config.** to list the 1747-SCNR ControlNet Scanner Module.

Note that the # column shows the slot number that the scanner occupies. This slot number replaces the 'e' in the memory addresses.

- d. Close the Read IO Configuration from Online Processor screen.

## Drive and Adapter Parameter Settings

The following drive and adapter settings were used for the example ladder logic program in this section.

Device	Parameter	Value	Description
PowerFlex 70 EC Drive	90 - [Speed Ref A Sel]	22 (DPI Port 5)	Assigns 20-COMM-C/-Q to be used for the Reference.
	300 - [Data In A1]	140	Points to Par. 140 - [Accel Time 1]
	301 - [Data In A2]	142	Points to Par. 142 - [Decel Time 1]
	302 - [Data In B1]	100	Points to Par. 100 - [Jog Speed]
	303 - [Data In B2]	155	Points to Par. 155 - [Stop Mode A]
	304 - [Data In C1]	101	Points to Par. 101 - [Preset Speed 1]
	305 - [Data In C2]	102	Points to Par. 102 - [Preset Speed 2]
	306 - [Data In D1]	103	Points to Par. 103 - [Preset Speed 3]
	307 - [Data In D2]	104	Points to Par. 104 - [Preset Speed 4]
	310 - [Data Out A1]	140	Points to Par. 140 - [Accel Time 1]
	311 - [Data Out A2]	142	Points to Par. 142 - [Decel Time 1]
	312 - [Data Out B1]	100	Points to Par. 100 - [Jog Speed]
	313 - [Data Out B2]	155	Points to Par. 155 - [Stop Mode A]
	314 - [Data Out C1]	101	Points to Par. 101 - [Preset Speed 1]
	315 - [Data Out C2]	102	Points to Par. 102 - [Preset Speed 2]
	316 - [Data Out D1]	103	Points to Par. 103 - [Preset Speed 3]
	317 - [Data Out D2]	104	Points to Par. 104 - [Preset Speed 4]
PowerFlex 750-Series Drive <sup>(1)</sup>	545 - [Spd Ref A Sel]	Port 0: Port 6 Reference	Assigns 20-COMM-C/Q to be used for the Reference.
	895 - [Data In A1]	Port 0: Accel Time 1	Points to Par. 535 in the drive.
	896 - [Data In A2]	Port 0: Testpoint Sel 1	Points to Par. 970 in the drive.
	897 - [Data In B1]	Port 5: Anlg Out1 Hi	Points to Par. 90 in Port 5 (I/O module).
	905 - [Data Out A1]	Port 0: DC Bus Volts	Points to Par. 11 in the drive.
	906 - [Data Out A2]	Port 0: Open Loop Fdbk	Points to Par. 137 in the drive.
	907 - [Data Out B1]	Port 5: Anlg Out0 Data	Points to Par. 77 in Port 5 (I/O module).
20-COMM-C or 20-COMM-Q Adapter	03 - [CN Addr Cfg]	2	Node address for the adapter.
	13 - [DPI I/O Cfg]	xxx1 1111	Enables Cmd/Ref and Datalinks A...D.
	25 - [M-S Input]	xxx1 1111	Configures the I/O Data to be transferred from the controller on the network to the drive.
	26 - [M-S Output]	xxx1 1111	Configures the I/O Data to be transferred from the drive to the controller on the network.

<sup>(1)</sup> In this example, the 20-COMM-C or 20-COMM-Q adapter/20-750-20COMM Communication Carrier Card is installed in Port 6, and a 24V I/O module is installed in Port 5. Also, Data In B2...D2 (Parameters 898...902) and Data Out B2...D2 (Parameters 908...912) are enabled, but not used.



**TIP:** Data In parameters are inputs into the drive that come from controller outputs (for example, data to write to a drive parameter). Data Out parameters are outputs from the drive that go to controller inputs (for example, data to read a drive parameter).

► **TIP:** When using a drive that has 16-bit Datalinks (PowerFlex 70, PowerFlex 700, and PowerFlex 700H drives) to transfer a 32-bit parameter, two contiguous drive Datalink parameters (for example, Data Out A1/A2, B1/B2, and so forth) are required. To determine if a parameter is a 32-bit parameter, see the Parameter section in the drive documentation and look for a  $\nabla^{32}$  symbol in the 'No.' column. (All parameters in PowerFlex 700 Series B drives are 32-bit parameters.) For example, parameter 3 - [Output Current] in a PowerFlex 70 EC drive is a 32-bit parameter. When using a drive that has 32-bit Datalinks (PowerFlex 700 VC, PowerFlex 700S, and PowerFlex 750-Series drives), only one drive Datalink parameter is required to transfer any parameter.

### Understanding SLC 500 Controller Data Table Addresses

Because the SLC 500 controller is a 16-bit platform and is used with the 32-bit 20-COMM-C or 20-COMM-Q adapter, the data will be transposed from the least-significant word (LSW) to the most-significant word (MSW) in the controller.

When the I/O was configured ([Chapter 4](#)), two available default memory addresses (M1:e.3 for input data and M0:e.3 for output data) were used. However, because memory addresses cannot be used to display real data, COP instructions will be used in this example to convert these addresses to N data table addresses. With this conversion, the M1:e.3 address will become N9:0 and the M0:e.3 address will become N10:0.

[Figure 5.17](#) shows an example ladder logic program to convert memory addresses to N data table addresses.

**Figure 5.17 SLC 500 Example Ladder Logic Program to Convert Memory Addresses**

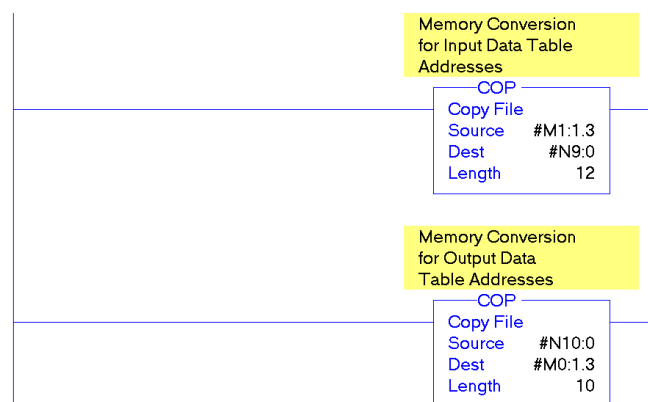

► **TIP:** In the ladder logic COP instructions, the number following the colon in the #M1 and #M0 addresses is the slot number in which the scanner resides. For example, if the 1747-SCNR scanner is in slot 3, then the #M1 address becomes #M1:3.3 and the #M0 address becomes #M0:3.3.

After the conversion, [Figure 5.18](#) shows the entire data file address structure for this example.

Figure 5.18 Data File Tables for Example Ladder Logic Program

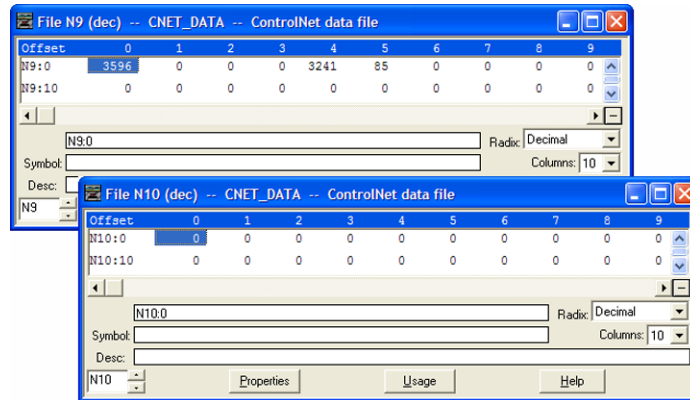

Depending on the drive, [Table 5.R](#), [Table 5.S](#), [Table 5.T](#), [Table 5.U](#), [Table 5.V](#), or [Table 5.W](#) shows the I/O definitions as they relate to the N9:0 and N10:0 data table addresses in [Figure 5.18](#) being used in this example.

PowerFlex 70, PowerFlex 700 with Standard Control, and PowerFlex 700H Drives

When using any of these products, which contain INT (16-bit format) data types, you will read from and write to a single data table address in the controller.

**Table 5.R SLC 500 Data Table Addresses for:  
PowerFlex 70 Drives with Standard or Enhanced Control  
PowerFlex 700 Drives with Standard Control  
PowerFlex 700H Drives**

Data Table Address	Description
N9:0	Reserved for scanner status
N9:1	Reserved for scanner status
N9:2	Logic Status (see <a href="#">Appendix D</a> )
N9:3	Speed Feedback
N9:4	Value of parameter assigned to Parameter 310 [Data Out A1]
N9:5	Value of parameter assigned to Parameter 311 [Data Out A2]
N9:6	Value of parameter assigned to Parameter 312 [Data Out B1]
N9:7	Value of parameter assigned to Parameter 313 [Data Out B2]
N9:8	Value of parameter assigned to Parameter 314 [Data Out C1]
N9:9	Value of parameter assigned to Parameter 315 [Data Out C2]
N9:10	Value of parameter assigned to Parameter 316 [Data Out D1]
N9:11	Value of parameter assigned to Parameter 317 [Data Out D2]
N10:0	Logic Command (see <a href="#">Appendix D</a> )
N10:1	Speed Reference
N10:2	Value of parameter assigned to Parameter 300 [Data In A1]
N10:3	Value of parameter assigned to Parameter 301 [Data In A2]
N10:4	Value of parameter assigned to Parameter 302 [Data In B1]
N10:5	Value of parameter assigned to Parameter 303 [Data In B2]
N10:6	Value of parameter assigned to Parameter 304 [Data In C1]
N10:7	Value of parameter assigned to Parameter 305 [Data In C2]
N10:8	Value of parameter assigned to Parameter 306 [Data In D1]
N10:9	Value of parameter assigned to Parameter 307 [Data In D2]

## PowerFlex 700 Drives with Vector Control and PowerFlex 700L Drives with 700 Control

When using any of these drives, which contain DINT (32-bit format) data types, you will read from and write to the LSW data table address in the controller.

**Table 5.S SLC 500 Data Table Addresses for:  
PowerFlex 700 Drives with Vector Control  
PowerFlex 700L Drives with 700 Control**

Data Table Address	Description
N9:0	Reserved for scanner status
N9:1	Reserved for scanner status
N9:2	Logic Status (see <a href="#">Appendix D</a> )
N9:3	Speed Feedback
N9:4	Value of parameter assigned to Parameter 310 [Data Out A1] LSW
N9:5	Value of parameter assigned to Parameter 310 [Data Out A1] MSW
N9:6	Value of parameter assigned to Parameter 311 [Data Out A2] LSW
N9:7	Value of parameter assigned to Parameter 311 [Data Out A2] MSW
N9:8	Value of parameter assigned to Parameter 312 [Data Out B1] LSW
N9:9	Value of parameter assigned to Parameter 312 [Data Out B1] MSW
N9:10	Value of parameter assigned to Parameter 313 [Data Out B2] LSW
N9:11	Value of parameter assigned to Parameter 313 [Data Out B2] MSW
N9:12	Value of parameter assigned to Parameter 314 [Data Out C1] LSW
N9:13	Value of parameter assigned to Parameter 314 [Data Out C1] MSW
N9:14	Value of parameter assigned to Parameter 315 [Data Out C2] LSW
N9:15	Value of parameter assigned to Parameter 315 [Data Out C2] MSW
N9:16	Value of parameter assigned to Parameter 316 [Data Out D1] LSW
N9:17	Value of parameter assigned to Parameter 316 [Data Out D1] MSW
N9:18	Value of parameter assigned to Parameter 317 [Data Out D2] LSW
N9:19	Value of parameter assigned to Parameter 317 [Data Out D2] MSW
N10:0	Logic Command (see <a href="#">Appendix D</a> )
N10:1	Speed Reference
N10:2	Value of parameter assigned to Parameter 300 [Data In A1] LSW
N10:3	Value of parameter assigned to Parameter 300 [Data In A1] MSW
N10:4	Value of parameter assigned to Parameter 301 [Data In A2] LSW
N10:5	Value of parameter assigned to Parameter 301 [Data In A2] MSW
N10:6	Value of parameter assigned to Parameter 302 [Data In B1] LSW
N10:7	Value of parameter assigned to Parameter 302 [Data In B1] MSW
N10:8	Value of parameter assigned to Parameter 303 [Data In B2] LSW
N10:9	Value of parameter assigned to Parameter 303 [Data In B2] MSW
N10:10	Value of parameter assigned to Parameter 304 [Data In C1] LSW
N10:11	Value of parameter assigned to Parameter 304 [Data In C1] MSW
N10:12	Value of parameter assigned to Parameter 305 [Data In C2] LSW
N10:13	Value of parameter assigned to Parameter 305 [Data In C2] MSW
N10:14	Value of parameter assigned to Parameter 306 [Data In D1] LSW
N10:15	Value of parameter assigned to Parameter 306 [Data In D1] MSW
N10:16	Value of parameter assigned to Parameter 307 [Data In D2] LSW
N10:17	Value of parameter assigned to Parameter 307 [Data In D2] MSW

PowerFlex 700S, PowerFlex 700L with 700S Control, PowerFlex 750-Series, and PowerFlex Digital DC Drives

When using any of these drives, which contain both DINT (32-bit format) and REAL (floating point format) data types, you will always read from and write to the LSW data table address in the controller first. Then if the data value exceeds 16 bits, the remaining value will be in the MSW data table address.

**Table 5.T SLC 500 Data Table Addresses for PowerFlex 700S Drives (Phase I Control)**

Data Table Address	Description
N9:0	Reserved for scanner status
N9:1	Reserved for scanner status
N9:2	Logic Status (see <a href="#">Appendix D</a> )
N9:3	Not Used
N9:4	Speed Feedback LSW
N9:5	Speed Feedback MSW
N9:6	Value of parameter assigned to Parameter 724/725 [Data Out A1] LSW
N9:7	Value of parameter assigned to Parameter 724/725 [Data Out A1] MSW
N9:8	Value of parameter assigned to Parameter 726/727 [Data Out A2] LSW
N9:9	Value of parameter assigned to Parameter 726/727 [Data Out A2] MSW
N9:10	Value of parameter assigned to Parameter 728/729 [Data Out B1] LSW
N9:11	Value of parameter assigned to Parameter 728/729 [Data Out B1] MSW
N9:12	Value of parameter assigned to Parameter 730/731 [Data Out B2] LSW
N9:13	Value of parameter assigned to Parameter 730/731 [Data Out B2] MSW
N9:14	Value of parameter assigned to Parameter 732/733 [Data Out C1] LSW
N9:15	Value of parameter assigned to Parameter 732/733 [Data Out C1] MSW
N9:16	Value of parameter assigned to Parameter 734/735 [Data Out C2] LSW
N9:17	Value of parameter assigned to Parameter 734/735 [Data Out C2] MSW
N9:18	Value of parameter assigned to Parameter 736/737 [Data Out D1] LSW
N9:19	Value of parameter assigned to Parameter 736/737 [Data Out D1] MSW
N9:20	Value of parameter assigned to Parameter 738/739 [Data Out D2] LSW
N9:21	Value of parameter assigned to Parameter 738/739 [Data Out D2] MSW
N10:0	Logic Command (see <a href="#">Appendix D</a> )
N10:1	Not Used
N10:2	Speed Reference LSW
N10:3	Speed Reference MSW
N10:4	Value of parameter assigned to Parameter 707/708 [Data In A1] LSW
N10:5	Value of parameter assigned to Parameter 707/708 [Data In A1] MSW
N10:6	Value of parameter assigned to Parameter 709/710 [Data In A2] LSW
N10:7	Value of parameter assigned to Parameter 709/710 [Data In A2] MSW
N10:8	Value of parameter assigned to Parameter 711/712 [Data In B1] LSW
N10:9	Value of parameter assigned to Parameter 711/712 [Data In B1] MSW
N10:10	Value of parameter assigned to Parameter 713/714 [Data In B2] LSW
N10:11	Value of parameter assigned to Parameter 713/714 [Data In B2] MSW
N10:12	Value of parameter assigned to Parameter 715/716 [Data In C1] LSW
N10:13	Value of parameter assigned to Parameter 715/716 [Data In C1] MSW
N10:14	Value of parameter assigned to Parameter 717/718 [Data In C2] LSW
N10:15	Value of parameter assigned to Parameter 717/718 [Data In C2] MSW
N10:16	Value of parameter assigned to Parameter 719/720 [Data In D1] LSW
N10:17	Value of parameter assigned to Parameter 719/720 [Data In D1] MSW
N10:18	Value of parameter assigned to Parameter 721/722 [Data In D2] LSW
N10:19	Value of parameter assigned to Parameter 721/722 [Data In D2] MSW

**Table 5.U SLC 500 Data Table Addresses for:  
PowerFlex 700S Drives with Phase II Control  
PowerFlex 700L Drives with 700S Control**

Data Table Address	Description
N9:0	Reserved for scanner status
N9:1	Reserved for scanner status
N9:2	Logic Status (see <a href="#">Appendix D</a> )
N9:3	Not Used
N9:4	Speed Feedback LSW
N9:5	Speed Feedback MSW
N9:6	Value of parameter assigned to Parameter 660 [DPI Data Out A1] LSW
N9:7	Value of parameter assigned to Parameter 660 [DPI Data Out A1] MSW
N9:8	Value of parameter assigned to Parameter 661 [DPI Data Out A2] LSW
N9:9	Value of parameter assigned to Parameter 661 [DPI Data Out A2] MSW
N9:10	Value of parameter assigned to Parameter 662 [DPI Data Out B1] LSW
N9:11	Value of parameter assigned to Parameter 662 [DPI Data Out B1] MSW
N9:12	Value of parameter assigned to Parameter 663 [DPI Data Out B2] LSW
N9:13	Value of parameter assigned to Parameter 663 [DPI Data Out B2] MSW
N9:14	Value of parameter assigned to Parameter 664 [DPI Data Out C1] LSW
N9:15	Value of parameter assigned to Parameter 664 [DPI Data Out C1] MSW
N9:16	Value of parameter assigned to Parameter 665 [DPI Data Out C2] LSW
N9:17	Value of parameter assigned to Parameter 665 [DPI Data Out C2] MSW
N9:18	Value of parameter assigned to Parameter 666 [DPI Data Out D1] LSW
N9:19	Value of parameter assigned to Parameter 666 [DPI Data Out D1] MSW
N9:20	Value of parameter assigned to Parameter 667 [DPI Data Out D2] LSW
N9:21	Value of parameter assigned to Parameter 667 [DPI Data Out D2] MSW
N10:0	Logic Command (see <a href="#">Appendix D</a> )
N10:1	Not Used
N10:2	Speed Reference LSW
N10:3	Speed Reference MSW
N10:4	Value of parameter assigned to Parameter 651 [DPI Data In A1] LSW
N10:5	Value of parameter assigned to Parameter 651 [DPI Data In A1] MSW
N10:6	Value of parameter assigned to Parameter 652 [DPI Data In A2] LSW
N10:7	Value of parameter assigned to Parameter 652 [DPI Data In A2] MSW
N10:8	Value of parameter assigned to Parameter 653 [DPI Data In B1] LSW
N10:9	Value of parameter assigned to Parameter 653 [DPI Data In B1] MSW
N10:10	Value of parameter assigned to Parameter 654 [DPI Data In B2] LSW
N10:11	Value of parameter assigned to Parameter 654 [DPI Data In B2] MSW
N10:12	Value of parameter assigned to Parameter 655 [DPI Data In C1] LSW
N10:13	Value of parameter assigned to Parameter 655 [DPI Data In C1] MSW
N10:14	Value of parameter assigned to Parameter 656 [DPI Data In C2] LSW
N10:15	Value of parameter assigned to Parameter 656 [DPI Data In C2] MSW
N10:16	Value of parameter assigned to Parameter 657 [DPI Data In D1] LSW
N10:17	Value of parameter assigned to Parameter 657 [DPI Data In D1] MSW
N10:18	Value of parameter assigned to Parameter 658 [DPI Data In D2] LSW
N10:19	Value of parameter assigned to Parameter 658 [DPI Data In D2] MSW

**Table 5.V SLC 500 Data Table Addresses for PowerFlex 750-Series Drives**

Data Table Address	Description
N9:0	Reserved for scanner status
N9:1	Reserved for scanner status
N9:2	Logic Status (see <a href="#">Appendix D</a> )
N9:3	Not Used
N9:4	Speed Feedback LSW
N9:5	Speed Feedback MSW
N9:6	Value of parameter assigned to Parameter 905 [Data Out A1] LSW
N9:7	Value of parameter assigned to Parameter 905 [Data Out A1] MSW
N9:8	Value of parameter assigned to Parameter 906 [Data Out A2] LSW
N9:9	Value of parameter assigned to Parameter 906 [Data Out A2] MSW
N9:10	Value of parameter assigned to Parameter 907 [Data Out B1] LSW
N9:11	Value of parameter assigned to Parameter 907 [Data Out B1] MSW
N9:12	Value of parameter assigned to Parameter 908 [Data Out B2] LSW
N9:13	Value of parameter assigned to Parameter 908 [Data Out B2] MSW
N9:14	Value of parameter assigned to Parameter 909 [Data Out C1] LSW
N9:15	Value of parameter assigned to Parameter 909 [Data Out C1] MSW
N9:16	Value of parameter assigned to Parameter 910 [Data Out C2] LSW
N9:17	Value of parameter assigned to Parameter 910 [Data Out C2] MSW
N9:18	Value of parameter assigned to Parameter 911 [Data Out D1] LSW
N9:19	Value of parameter assigned to Parameter 911 [Data Out D1] MSW
N9:20	Value of parameter assigned to Parameter 912 [Data Out D2] LSW
N9:21	Value of parameter assigned to Parameter 912 [Data Out D2] MSW
N10:0	Logic Command (see <a href="#">Appendix D</a> )
N10:1	Not Used
N10:2	Speed Reference LSW
N10:3	Speed Reference MSW
N10:4	Value of parameter assigned to Parameter 895 [Data In A1] LSW
N10:5	Value of parameter assigned to Parameter 895 [Data In A1] MSW
N10:6	Value of parameter assigned to Parameter 896 [Data In A2] LSW
N10:7	Value of parameter assigned to Parameter 896 [Data In A2] MSW
N10:8	Value of parameter assigned to Parameter 897 [Data In B1] LSW
N10:9	Value of parameter assigned to Parameter 897 [Data In B1] MSW
N10:10	Value of parameter assigned to Parameter 898 [Data In B2] LSW
N10:11	Value of parameter assigned to Parameter 898 [Data In B2] MSW
N10:12	Value of parameter assigned to Parameter 899 [Data In C1] LSW
N10:13	Value of parameter assigned to Parameter 899 [Data In C1] MSW
N10:14	Value of parameter assigned to Parameter 900 [Data In C2] LSW
N10:15	Value of parameter assigned to Parameter 900 [Data In C2] MSW
N10:16	Value of parameter assigned to Parameter 901 [Data In D1] LSW
N10:17	Value of parameter assigned to Parameter 901 [Data In D1] MSW
N10:18	Value of parameter assigned to Parameter 902 [Data In D2] LSW
N10:19	Value of parameter assigned to Parameter 902 [Data In D2] MSW



**Table 5.W SLC 500 Data Table Addresses for PowerFlex Digital DC Drives**

Data Table Address	Description
N9:0	Reserved for scanner status
N9:1	Reserved for scanner status
N9:2	Logic Status (see <a href="#">Appendix D</a> )
N9:3	Speed Feedback
N9:4	Value of parameter assigned to Parameter 618 [Data Out A1] LSW
N9:5	Value of parameter assigned to Parameter 618 [Data Out A1] MSW
N9:6	Value of parameter assigned to Parameter 619 [Data Out A2] LSW
N9:7	Value of parameter assigned to Parameter 619 [Data Out A2] MSW
N9:8	Value of parameter assigned to Parameter 620 [Data Out B1] LSW
N9:9	Value of parameter assigned to Parameter 620 [Data Out B1] MSW
N9:10	Value of parameter assigned to Parameter 621 [Data Out B2] LSW
N9:11	Value of parameter assigned to Parameter 621 [Data Out B2] MSW
N9:12	Value of parameter assigned to Parameter 622 [Data Out C1] LSW
N9:13	Value of parameter assigned to Parameter 622 [Data Out C1] MSW
N9:14	Value of parameter assigned to Parameter 623 [Data Out C2] LSW
N9:15	Value of parameter assigned to Parameter 623 [Data Out C2] MSW
N9:16	Value of parameter assigned to Parameter 624 [Data Out D1] LSW
N9:17	Value of parameter assigned to Parameter 624 [Data Out D1] MSW
N9:18	Value of parameter assigned to Parameter 625 [Data Out D2] LSW
N9:19	Value of parameter assigned to Parameter 625 [Data Out D2] MSW
N10:0	Logic Command (see <a href="#">Appendix D</a> )
N10:1	Speed Reference
N10:2	Value of parameter assigned to Parameter 610 [Data In A1] LSW
N10:3	Value of parameter assigned to Parameter 610 [Data In A1] MSW
N10:4	Value of parameter assigned to Parameter 611 [Data In A2] LSW
N10:5	Value of parameter assigned to Parameter 611 [Data In A2] MSW
N10:6	Value of parameter assigned to Parameter 612 [Data In B1] LSW
N10:7	Value of parameter assigned to Parameter 612 [Data In B1] MSW
N10:8	Value of parameter assigned to Parameter 613 [Data In B2] LSW
N10:9	Value of parameter assigned to Parameter 613 [Data In B2] MSW
N10:10	Value of parameter assigned to Parameter 614 [Data In C1] LSW
N10:11	Value of parameter assigned to Parameter 614 [Data In C1] MSW
N10:12	Value of parameter assigned to Parameter 615 [Data In C2] LSW
N10:13	Value of parameter assigned to Parameter 615 [Data In C2] MSW
N10:14	Value of parameter assigned to Parameter 616 [Data In D1] LSW
N10:15	Value of parameter assigned to Parameter 616 [Data In D1] MSW
N10:16	Value of parameter assigned to Parameter 617 [Data In D2] LSW
N10:17	Value of parameter assigned to Parameter 617 [Data In D2] MSW

To operate any drive and view its status using the data table addresses, Human Machine Interface devices (PanelView, and so forth), or a ladder logic program, you will need to create descriptive controller data table addresses ([Table 5.X](#) and [Table 5.Y](#)) and a ladder logic program that will pass the controller address data to the program data table addresses.

**Table 5.X SLC 500 and Program Data Table Address Descriptions for Example Logic Status/Feedback Ladder Logic Program**

Description	SLC 500 Data Table Address	Description	Program Data Table Address
Drive Ready	N9:2/0	Status Ready	B3:1/0
Drive Active	N9:2/1	Status Active	B3:1/1
Actual Direction (XIO)	N9:2/3	Status Forward	B3:1/3
Actual Direction (XIC)	N9:2/3	Status Reverse	B3:1/4
Drive Faulted	N9:2/7	Status Faulted	B3:1/7
Drive At Speed	N9:2/8	Status At Speed	B3:1/8
Speed Feedback (PowerFlex 70) (PowerFlex 753/755)	N9:3 N9:4	Speed Feedback (PowerFlex 70) (PowerFlex 753/755)	N20:1 F8:1

**Table 5.Y Program and SLC 500 Data Table Address Descriptions for Example Logic Command/Reference Ladder Logic Program**

Description	Program Data Table Address	Description	SLC 500 Data Table Address
Command Stop	B3:20/0	Drive Stop	N10:0/0
Command Start	B3:20/1	Drive Start	N10:0/1
Command Jog	B3:20/2	Drive Jog	N10:0/2
Command Clear Faults	B3:20/3	Drive Clear Faults	N10:0/3
Command Forward Reverse (XIO)	B3:20/4	Drive Forward	N10:0/4
Command Forward Reverse (XIC)	B3:20/4	Drive Reverse	N10:0/5
Speed Reference (PowerFlex 70) (PowerFlex 753/755)	N30:1 F8:3	Speed Reference (PowerFlex 70) (PowerFlex 753/755)	N10:1 N10:2

**Important:** In addition to the Run mode for the processor, the scanner also has its own Run mode. To change the scanner mode from IDLE to RUN, set Bit 10 in data table address O:e.0, where e = the scanner slot number. For this example, we set Bit 10 in data table address O:1.0.

An example ladder logic program that uses these descriptive controller data table addresses and passes their data to the descriptive program data table addresses is shown in [Figure 5.19](#), [Figure 5.20](#), [Figure 5.21](#), and [Figure 5.22](#).

Figure 5.19 SLC 500 Example Ladder Logic Program for Logic Status

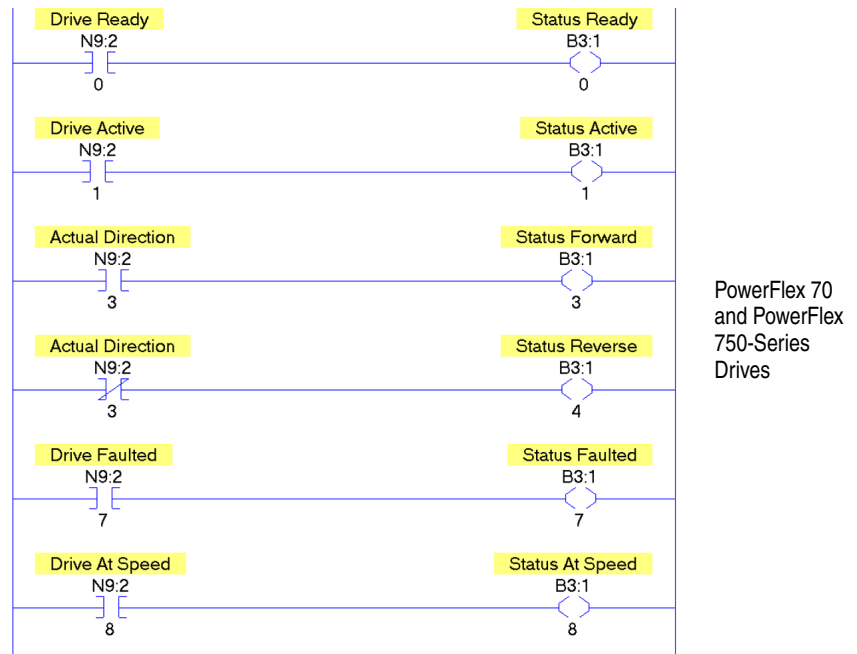
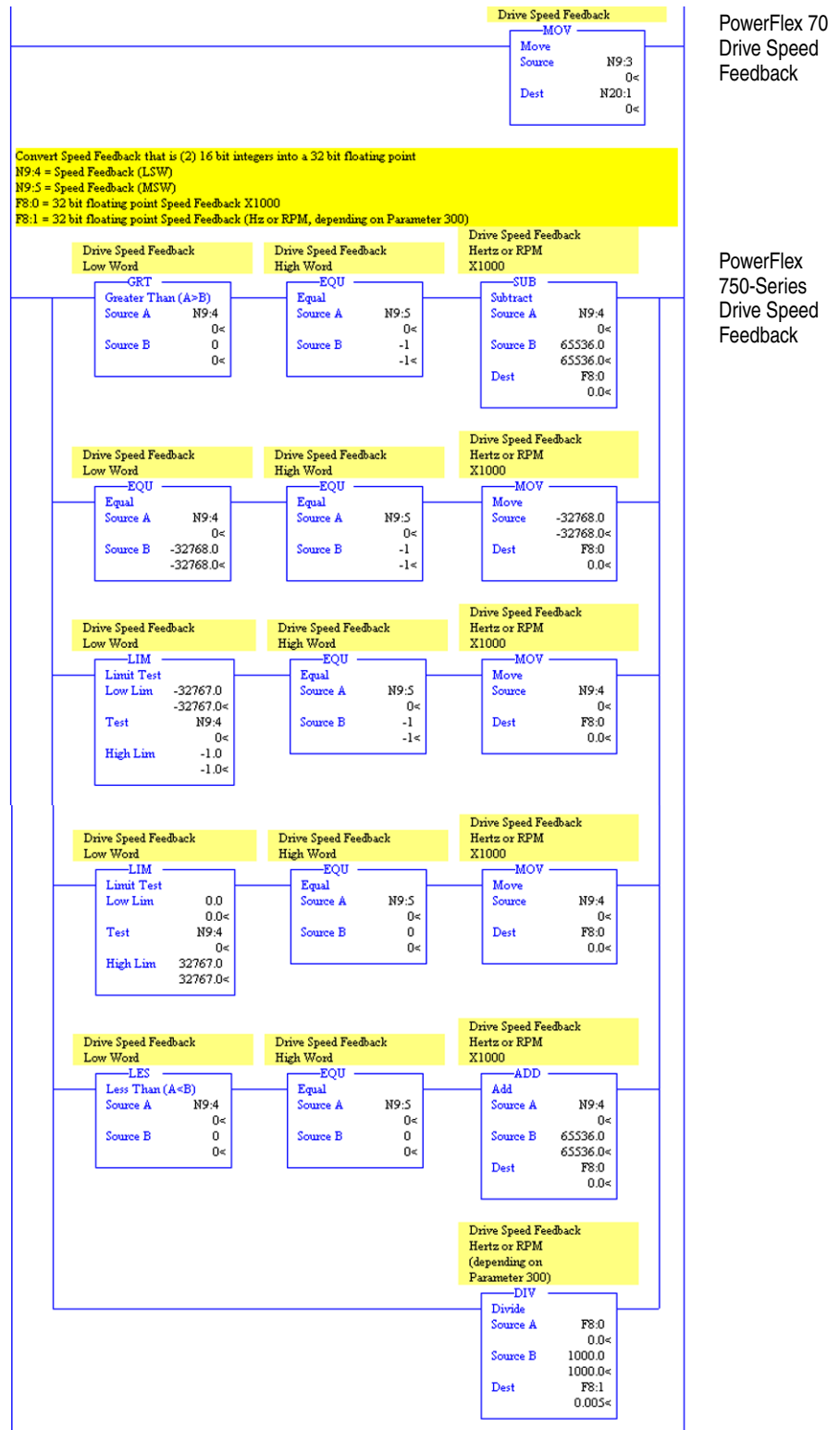

Figure 5.20 SLC 500 Example Ladder Logic Program for Speed Feedback



Depending on the drive being used, see one of the following subsections for information on speed Reference and Feedback scaling.

Subsection	Page
<a href="#">PowerFlex 70/700/700H and PowerFlex 700L Drives with 700 Control</a>	<a href="#">5-9</a>
<a href="#">PowerFlex 700S and PowerFlex 700L Drives with 700S Control</a>	<a href="#">5-10</a>
<a href="#">PowerFlex 753/755 Drives</a>	<a href="#">5-10</a>
<a href="#">PowerFlex Digital DC Drives</a>	<a href="#">5-11</a>

Figure 5.21 SLC 500 Example Ladder Logic Program for Logic Command

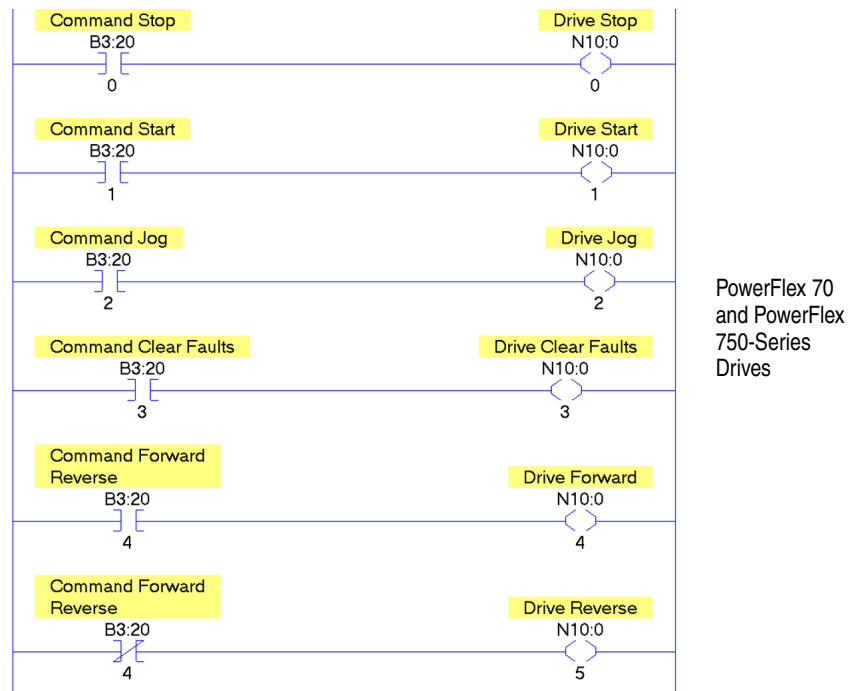
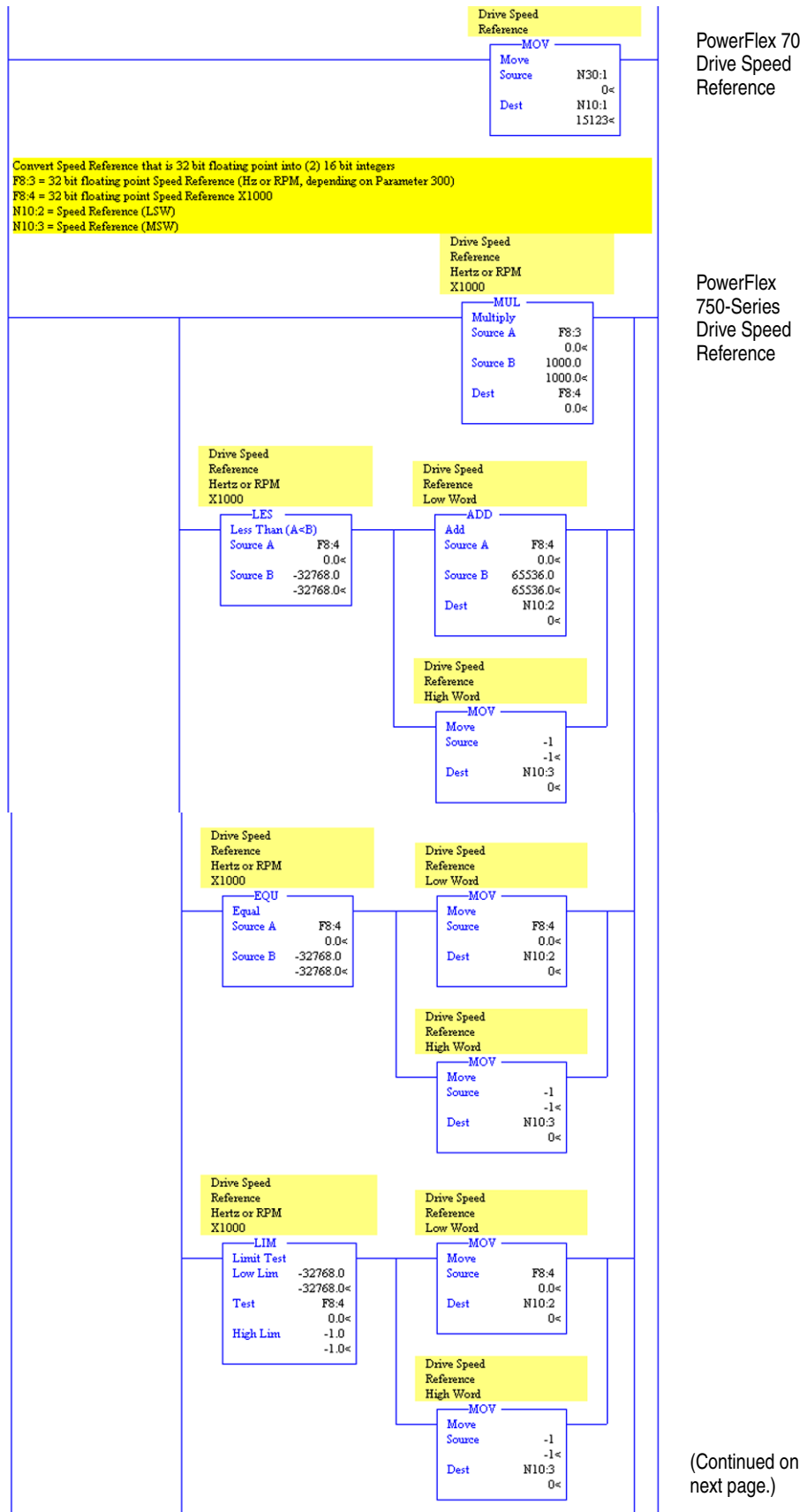
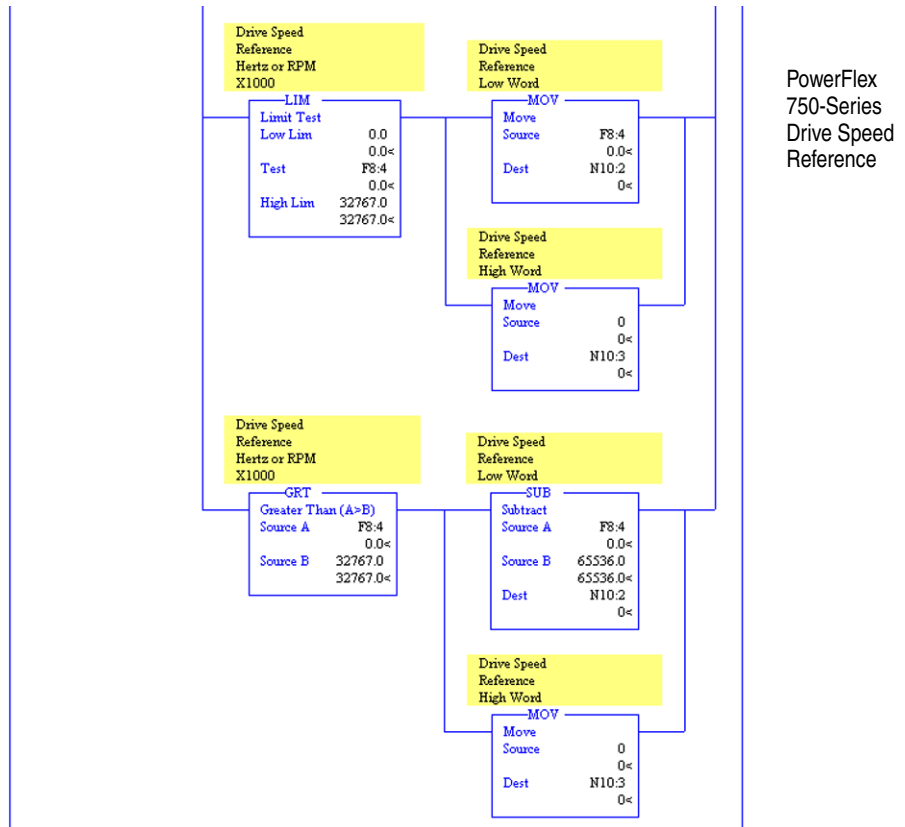

Figure 5.22 SLC 500 Example Ladder Logic Program for Speed Reference



(Continued on next page.)

(Continued from previous page.)



**Notes:**



## Using Explicit Messaging

This chapter provides information and examples that explain how to use Explicit Messaging to configure and monitor the adapter and connected PowerFlex 7-Class drive or PowerFlex 750-Series drive.

**Important:** When used in a PowerFlex 750-Series drive, the 20-COMM-C or 20-COMM-Q adapter must have firmware 3.001 or later to support explicit messaging to drive parameters (Port 0). Furthermore, the adapter requires firmware 3.002 or later for explicit messaging to parameters of peripherals in drive Ports 1...14.

Topic	Page
<a href="#">About Explicit Messaging</a>	<a href="#">6-2</a>
<a href="#">Performing Explicit Messages</a>	<a href="#">6-3</a>
<a href="#">ControlLogix Controller Examples</a>	<a href="#">6-4</a>
<a href="#">PLC-5 Controller Examples</a>	<a href="#">6-23</a>
<a href="#">SLC 500 Controller Examples</a>	<a href="#">6-40</a>



**ATTENTION:** Risk of injury or equipment damage exists. The examples in this publication are intended solely for purposes of example. There are many variables and requirements with any application. Rockwell Automation does not assume responsibility or liability (to include intellectual property liability) for actual use of the examples shown in this publication.



**ATTENTION:** Risk of equipment damage exists. If Explicit Messages are programmed to write parameter data to Nonvolatile Storage (NVS) frequently, the NVS will quickly exceed its life cycle and cause the drive to malfunction. Do not create a program that frequently uses Explicit Messages to write parameter data to NVS. Datalinks do not write to NVS and should be used for frequently changed parameters.

Refer to [Chapter 5](#) for information about the I/O Image, using Logic Command/Status, Reference/Feedback, and Datalinks.

## About Explicit Messaging

Explicit Messaging is used to transfer data that does not require continuous updates. With Explicit Messaging, you can configure and monitor a slave device’s parameters on the network.

**Important:** When an explicit message is performed, by default no connection is made because it is an ‘unconnected’ message. When timing of the message transaction is important, you can create a dedicated message connection between the controller and drive by checking the ‘Connected’ box on the Communications tab message configuration screen during message setup. These message connections are in addition to the I/O connection. However, the trade off for more message connections is decreased network performance. If your application cannot tolerate this, we recommend to not check the ‘Connected’ box.

**Important:** PowerFlex 7-Class and PowerFlex 750-Series drives have explicit messaging limitations. [Table 6.A](#) shows the ControlNet Object Class code compatibilities for these drives.

**Table 6.A Explicit Messaging Class Code Compatibility with Drives**

ControlNet Object Class Code	PowerFlex 7-Class Drives	PowerFlex 750-Series Drives	Explicit Messaging Function
Parameter Object 0x0F	Yes	No	Single parameter reads/writes
DPI Parameter Object 0x93	Yes	Yes <sup>(1)</sup> with limitations	Single and scattered parameter reads/writes
Host DPI Parameter Object 0x9F	No	Yes <sup>(2)</sup> with limitations	Single and scattered parameter reads/writes

<sup>(1)</sup> Enables access to drive parameters (Port 0), DPI device parameters (Ports 1...6 only), and Host parameters (Ports 7...14 only). For example, DPI Parameter Object Class code 0x93 can access a 20-COMM-C adapter in Port 6. However, Class code 0x93 cannot access, for example, the Host parameters in a 24V I/O option module in Port 5. See [DPI Parameter Object on page C-16](#) for instance (parameter) numbering.

<sup>(2)</sup> Enables access to drive parameters (Port 0) and Host parameters for all ports (1...14). Host DPI Parameter Object Class code 0x9F cannot access DPI (device) parameters. For example, if a 20-750-DNET option module is in Port 4, its Host parameters can be accessed, but not its DPI (device) parameters. See [Host DPI Parameter Object on page C-30](#) for instance (parameter) numbering.

## Performing Explicit Messages

There are five basic events in the Explicit Messaging process. The details of each step will vary depending on the type of controller being used. See the documentation for your controller.

**Important:** There must be a request message and a response message for all Explicit Messages, whether you are reading or writing data.

**Figure 6.1** Explicit Message Process

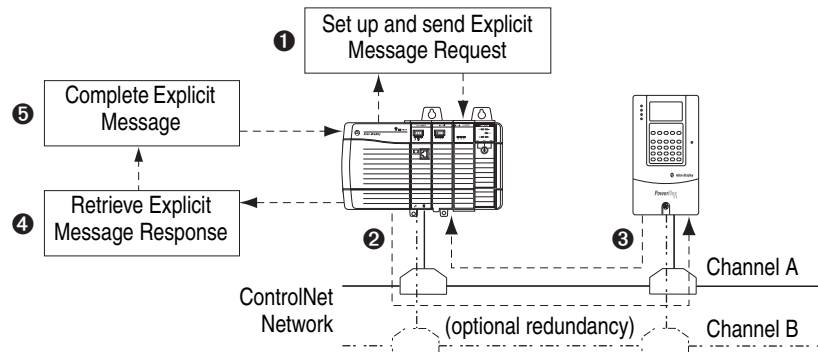

Event	Description
①	You format the required data and set up the ladder logic program to send an Explicit Message request to the scanner or bridge module (download).
②	The scanner or bridge module transmits the Explicit Message Request to the slave device over the network.
③	The slave device transmits the Explicit Message Response back to the scanner. The data is stored in the scanner buffer.
④	The controller retrieves the Explicit Message Response from the scanner's buffer (upload).
⑤	The Explicit Message is complete.

For information on the maximum number of Explicit Messages that can be executed at a time, see the documentation for the scanner or bridge and/or controller that is being used.

## ControlLogix Controller Examples

► **TIP:** To display the Message Configuration screen in RSLogix 5000 software, add a message instruction (MSG), create a new tag for the message (Properties: Base tag type, MESSAGE data type, controller scope), and click the  button in the message instruction.

For supported classes, instances, and attributes, see [Appendix C, ControlNet Objects](#).

### Read a Single Parameter

ControlLogix Controller Example Ladder Logic Program to Read a Single Parameter Using RSLogix 5000 Software, Version 15.00 or Later

A Parameter Read message is used to read a single parameter. This read message example reads the value of parameter 003 - [Output Current] in a PowerFlex 7-Class drive.

**Important:** Parameter Object Class code 0x0F is not supported in PowerFlex 750-Series drives. To do a single parameter read, follow the RSLogix 5000 software (any version) single read example on [page 6-6](#).

**Table 6.B Example Controller Tags to Read a Single Parameter**

Operand	Controller Tags for Single Read Message	Data Type
XIC	Execute_Single_Read_Message	BOOL
MSG	Single_Read_Message	MESSAGE

**Figure 6.2 Example Ladder Logic to Read a Single Parameter**



## ControlLogix Controller – Formatting a Message to Read a Single Parameter Using RSLogix 5000 Software, Version 15.00 or Later

**Figure 6.3 Parameter Read Single Message Configuration Screens**

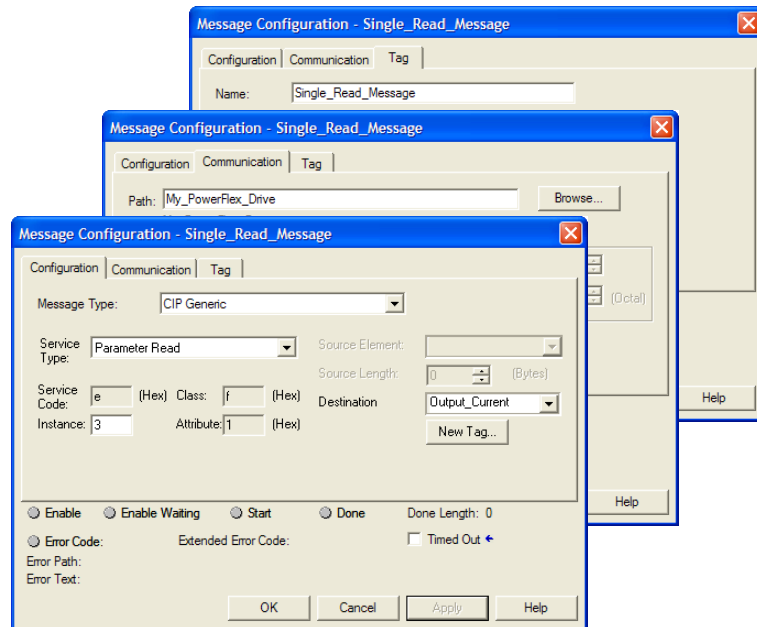

The following table identifies the data that is required in each box to configure a message to read a single parameter.

Configuration Tab	Example Value	Description
Message Type	CIP Generic	Used to access the Parameter Object in the adapter.
Service Type <sup>(1)</sup>	Parameter Read	This service is used to read a parameter value.
Service Code <sup>(1)</sup>	e (Hex.)	Code for the requested service.
Class	f (Hex.)	Class ID for the DPI Parameter Object.
Instance <sup>(2)</sup>	3 (Dec.)	Instance number is the same as parameter number.
Attribute	1 (Hex.)	Attribute number for the Parameter Value attribute.
Destination	Output_Current <sup>(4)</sup>	The tag where the data that is read is stored.
Communication Tab	Example Value	Description
Path <sup>(3)</sup>	My_PowerFlex_Drive	The path is the route that the message will follow.
Tag Tab	Example Value	Description
Name	Single_Read_Message	The name for the message.

- <sup>(1)</sup> The default setting for Service Type is 'Custom', enabling entry of a Service Code not available from the Service Type pull-down menu. When choosing a Service Type other than 'Custom' from the pull-down menu, an appropriate Hex. value is automatically assigned to the Service Code box which is dimmed (unavailable).
- <sup>(2)</sup> Only drive parameters (Port 0) can be read using Parameter Object Class code 0x0F. To read a parameter of a peripheral in another port, use DPI Parameter Object Class code 0x93 (see [page 6-6](#)).
- <sup>(3)</sup> Click **Browse** to find the path, or type in the name of the device listed in the I/O Configuration folder.
- <sup>(4)</sup> In this example, Output Current is a 32-bit integer parameter requiring the Data Type field to be set to 'DINT' when creating the controller tag. If the parameter being read is a 16-bit integer, the tag Data Type field must be set to 'INT'. When using a PowerFlex 700S drive, Output Current is a floating point number requiring the Data Type field to be set to 'REAL' when creating the controller tag. See the drive documentation to determine the size of the parameter and its data type (16-bit or 32-bit integer or REAL).

ControlLogix Controller Example Ladder Logic Program to Read a Single Parameter Using RSLogix 5000 Software, Any Version

A Get Attribute Single message is used to read a single parameter. This read message example reads the value of parameter 003 - [Output Current] in a PowerFlex 7-Class drive.

**Important:** See [Table 6.A on page 6-2](#) for limitations of PowerFlex 7-Class and PowerFlex 750-Series drives when using DPI Parameter Object Class code 0x93 or Host DPI Parameter Object Class code 0x9F for explicit messaging.

**Table 6.C Example Controller Tags to Read a Single Parameter**

Operand	Controller Tags for Single Read Message	Data Type
XIC	Execute_Single_Read_Message	BOOL
MSG	Single_Read_Message	MESSAGE

**Figure 6.4 Example Ladder Logic to Read a Single Parameter**

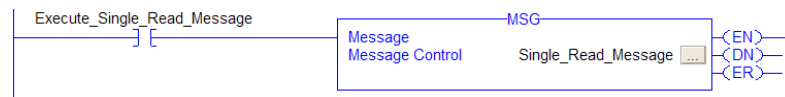

## ControlLogix Controller – Formatting a Message to Read a Single Parameter Using RSLogix 5000 Software, Any Version

**Figure 6.5 Get Attribute Single Message Configuration Screens**

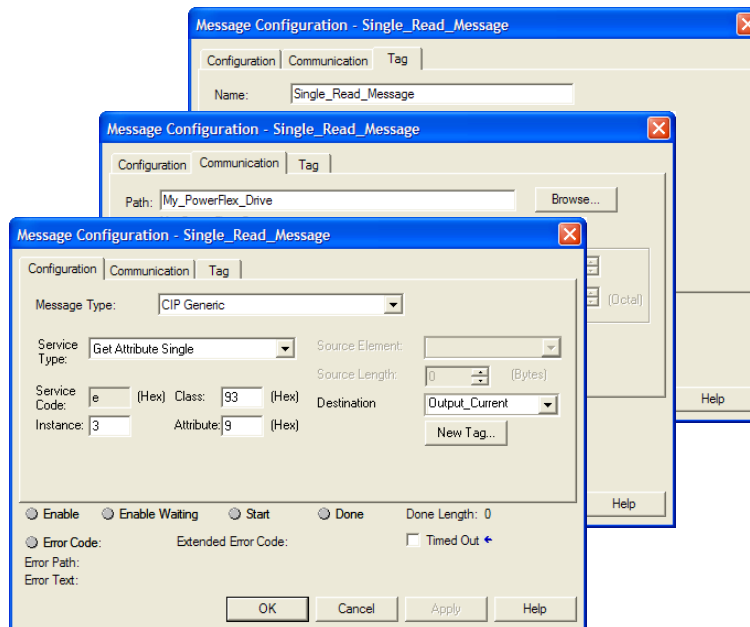

The following table identifies the data that is required in each box to configure a message to read a single parameter.

Configuration Tab	Example Value	Description
Message Type	CIP Generic	Used to access the Parameter Object in the adapter.
Service Type <sup>(1)</sup>	Get Attribute Single	This service is used to read a parameter value.
Service Code <sup>(1)</sup>	e (Hex.)	Code for the requested service.
Class	93 or 9F (Hex.) <sup>(4)</sup>	Class ID for the DPI Parameter Object.
Instance <sup>(2)</sup>	3 (Dec.)	Instance number is the same as parameter number.
Attribute	9 (Hex.)	Attribute number for the Parameter Value attribute.
Destination	Output_Current <sup>(5)</sup>	The tag where the data that is read is stored.
Communication Tab	Example Value	Description
Path <sup>(3)</sup>	My_PowerFlex_Drive	The path is the route that the message will follow.
Tag Tab	Example Value	Description
Name	Single_Read_Message	The name for the message.

<sup>(1)</sup> The default setting for Service Type is 'Custom', enabling entry of a Service Code not available from the Service Type pull-down menu. When choosing a Service Type other than 'Custom' from the pull-down menu, an appropriate Hex. value is automatically assigned to the Service Code box which is dimmed (unavailable).

<sup>(2)</sup> The instance is the parameter number in the drive (Port 0). To read a parameter in another port, see [DPI Parameter Object on page C-16](#) (Class code 0x93) or [Host DPI Parameter Object on page C-30](#) (Class code 0x9F) to determine the instance number. For example, to read parameter 4 of a peripheral in Port 5 of a PowerFlex 750-Series drive, the instance would be  $21504 + 4 = 21508$ .

<sup>(3)</sup> Click **Browse** to find the path, or type in the name of the device listed in the I/O Configuration folder.

<sup>(4)</sup> See [Table 6.A on page 6-2](#) for limitations of PowerFlex 7-Class and PowerFlex 750-Series drives when using DPI Parameter Object Class code 0x93 or Host DPI Parameter Object Class code 0x9F for explicit messaging.

<sup>(5)</sup> In this example, Output Current is a 32-bit integer parameter requiring the Data Type field to be set to 'DINT' when creating the controller tag. If the parameter being read is a 16-bit integer, the tag Data Type field must be set to 'INT'. When using a PowerFlex 700S or PowerFlex 750-Series drive, Output Current is a floating point number requiring the Data Type field to be set to 'REAL' when the creating controller tag. See the drive documentation to determine the size of the parameter and its data type (16-bit or 32-bit integer or REAL).

### Write a Single Parameter

ControlLogix Controller Example Ladder Logic Program to Write a Single Parameter Using RSLogix 5000 Software, Version 15.00 or Later

A Parameter Write message is used to write to a single parameter. This write message example writes a value to parameter 140 - [Accel Time 1] in a PowerFlex 7-Class drive.

**Important:** Parameter Object Class code 0x0F is not supported in PowerFlex 750-Series drives. To do a single parameter write, follow the RSLogix 5000 software (any version) single write example on [page 6-10](#).

**Table 6.D Example Controller Tags to Write a Single Parameter**

Operand	Controller Tags for Single Write Message	Data Type
XIC	Execute_Single_Write_Message	BOOL
MSG	Single_Write_Message	MESSAGE

**Figure 6.6 Example Ladder Logic to Write a Single Parameter**



**Important:** If the explicit message single write must be written continuously, use DPI Parameter Object Class code 0x93 or Host DPI Parameter Object Class code 0x9F and attribute A (10 decimal; see [page 6-11](#)). This writes to RAM—not NVS (EEPROM) memory. This example single write message using Class code F writes to NVS. Over time, continuous writes will exceed the EEPROM life cycle and cause the drive to malfunction.



## ControlLogix Controller – Formatting a Message to Write a Single Parameter Using RSLogix 5000 Software, Version 15.00 or Later

**Figure 6.7 Parameter Write Single Message Configuration Screens**

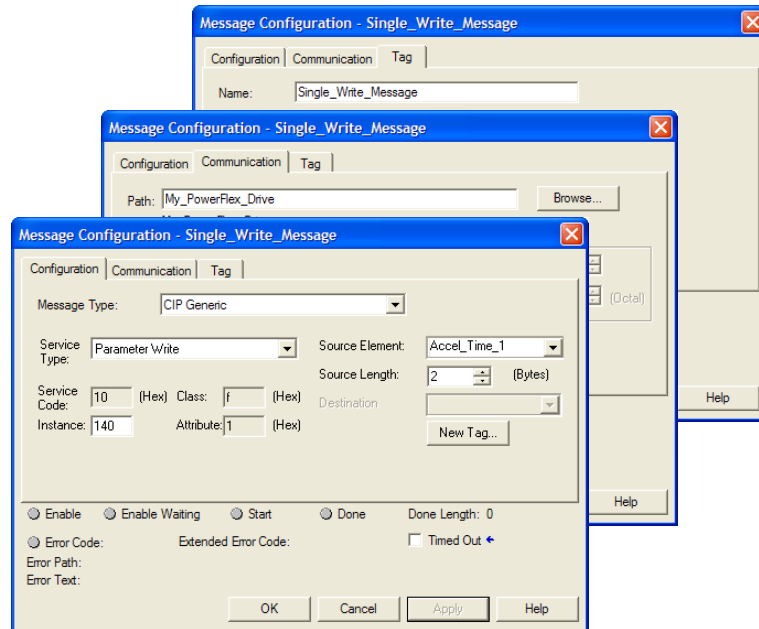

The following table identifies the data that is required in each box to configure a message to write a single parameter.

Configuration Tab	Example Value	Description
Message Type	CIP Generic	Used to access the Parameter Object in the adapter.
Service Type <sup>(1)</sup>	Parameter Write	This service is used to write a parameter value.
Service Code <sup>(1)</sup>	10 (Hex.)	Code for the requested service.
Class	f (Hex.)	Class ID for the DPI Parameter Object.
Instance <sup>(2)</sup>	140 (Dec.)	Instance number is the same as parameter number.
Attribute	1 (Hex.)	Attribute number for the Parameter Value attribute.
Source Element	Accel_Time_1 <sup>(4)</sup>	Name of the tag for any service data to be sent from the scanner or bridge to the adapter/drive.
Source Length	2 <sup>(4)</sup>	Number of bytes of service data to be sent in the message.
Communication Tab	Example Value	Description
Path <sup>(3)</sup>	My_PowerFlex_Drive	The path is the route that the message will follow.
Tag Tab	Example Value	Description
Name	Single_Write_Message	The name for the message.

- <sup>(1)</sup> The default setting for Service Type is 'Custom', enabling entry of a Service Code not available from the Service Type pull-down menu. When choosing a Service Type other than 'Custom' from the pull-down menu, an appropriate Hex. value is automatically assigned to the Service Code box which is dimmed (unavailable).
- <sup>(2)</sup> Only drive parameters (Port 0) can be written to using Parameter Object Class code 0x0F. To write to a parameter of a peripheral in another port, use DPI Parameter Object Class code 0x93 (see [page 6-10](#)).
- <sup>(3)</sup> Click **Browse** to find the path, or type in the name of the device listed in the I/O Configuration folder.
- <sup>(4)</sup> In this example, Accel Time 1 is a 16-bit integer parameter requiring the tag Data Type field to be set to 'INT' when creating the controller tag. If the parameter being written to is a 32-bit integer, the tag Data Type field must be set to 'DINT'. Also, the Source Length field on the Message Configuration screen must correspond to the selected Data Type in bytes (for example, 4 bytes for a DINT or a REAL). When using a PowerFlex 700S drive, Accel Time 1 is a floating point number requiring the Data Type field to be set to 'REAL' when creating the controller tag. See the drive documentation to determine the size of the parameter and its data type (16-bit or 32-bit integer or REAL).

ControlLogix Controller Example Ladder Logic Program to Write a Single Parameter Using RSLogix 5000 Software, Any Version

A Set Attribute Single message is used to write to a single parameter. This write message example writes a value to parameter 140 - [Accel Time 1] in a PowerFlex 7-Class drive.

**Important:** See [Table 6.A on page 6-2](#) for limitations of PowerFlex 7-Class and PowerFlex 750-Series drives when using DPI Parameter Object Class code 0x93 or Host DPI Parameter Object Class code 0x9F for explicit messaging.

**Table 6.E Example Controller Tags to Write a Single Parameter**

Operand	Controller Tags for Single Write Message	Data Type
XIC	Execute_Single_Write_Message	BOOL
MSG	Single_Write_Message	MESSAGE

**Figure 6.8 Example Ladder Logic to Write a Single Parameter**



## ControlLogix Controller – Formatting a Message to Write a Single Parameter Using RSLogix 5000 Software, Any Version

**Figure 6.9 Set Attribute Single Message Configuration Screens**

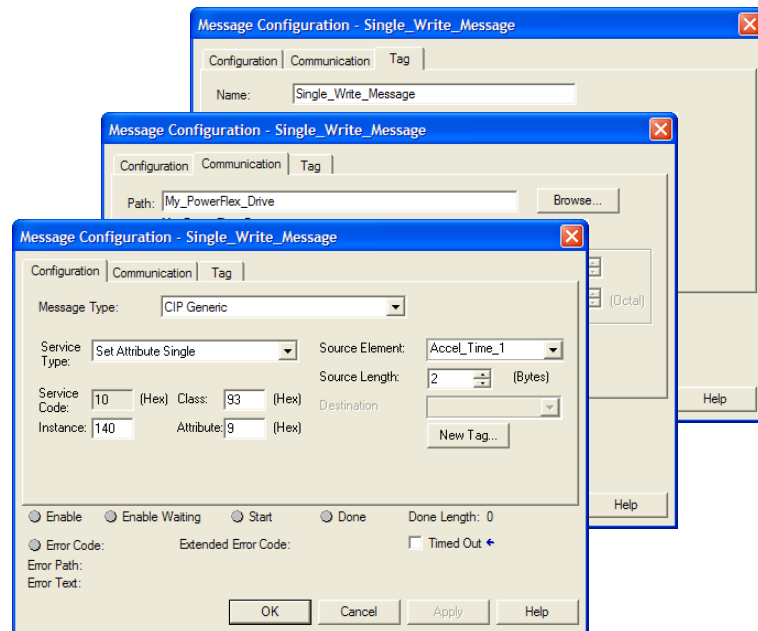

The following table identifies the data that is required in each box to configure a message to write a single parameter.

Configuration Tab	Example Value	Description
Message Type	CIP Generic	Used to access the Parameter Object in the adapter.
Service Type <sup>(1)</sup>	Set Attribute Single	This service is used to write a parameter value.
Service Code <sup>(1)</sup>	10 (Hex.)	Code for the requested service.
Class	93 or 9F (Hex.) <sup>(5)</sup>	Class ID for the DPI Parameter Object.
Instance <sup>(2)</sup>	140 (Dec.)	Instance number is the same as parameter number.
Attribute <sup>(3)</sup>	9 or A (Hex.)	Attribute number for the Parameter Value attribute.
Source Element	Accel_Time_1 <sup>(6)</sup>	Name of the tag for any service data to be sent from the scanner or bridge to the adapter/drive.
Source Length	2 <sup>(6)</sup>	Number of bytes of service data to be sent in the message.
Communication Tab	Example Value	Description
Path <sup>(4)</sup>	My_PowerFlex_Drive	The path is the route that the message will follow.
Tag Tab	Example Value	Description
Name	Single_Write_Message	The name for the message.

<sup>(1)</sup> The default setting for Service Type is 'Custom', enabling entry of a Service Code not available from the Service Type pull-down menu. When choosing a Service Type other than 'Custom' from the pull-down menu, an appropriate Hex. value is automatically assigned to the Service Code box which is dimmed (unavailable).

<sup>(2)</sup> The instance is the parameter number in the drive (Port 0). To write to a parameter in another port, see [DPI Parameter Object on page C-16](#) (Class code 0x93) or [Host DPI Parameter Object on page C-30](#) (Class code 0x9F) to determine the instance number. For example, to write to parameter 4 of a peripheral in Port 5 of a PowerFlex 750-Series drive, the instance would be 21504 + 4 = 21508.

<sup>(3)</sup> Setting the Attribute value to '9' will write the parameter value to the drive's Nonvolatile Storage (EEPROM) memory, which retains the parameter value even after the drive is power cycled. **Important:** When set to '9', the EEPROM may quickly exceed its life cycle and cause the drive to malfunction. Setting the Attribute value to 'A' (10 decimal) will write the parameter value to temporary memory, which deletes the parameter value after the drive is power cycled. When frequent write messages are required, we recommend using the 'A' (10 decimal) setting.

<sup>(4)</sup> Click **Browse** to find the path, or type in the name of the device listed in the I/O Configuration folder.

<sup>(5)</sup> See [Table 6.A on page 6-2](#) for limitations of PowerFlex 7-Class and PowerFlex 750-Series drives when using DPI Parameter Object Class code 0x93 or Host DPI Parameter Object Class code 0x9F for explicit messaging.

<sup>(6)</sup> In this example, Accel Time 1 is a 16-bit integer parameter requiring the tag Data Type field to be set to 'INT' when creating the controller tag. If the parameter being written to is a 32-bit integer, the tag Data Type field must be set to 'DINT'. Also, the Source Length field on the Message Configuration screen must correspond to the selected Data Type in bytes (for example, 4 bytes for a DINT or a REAL). When using a PowerFlex 700S or PowerFlex 750-Series drive, Accel Time 1 is a floating point number requiring the Data Type field to be set to 'REAL' when creating the controller tag. See the drive documentation to determine the size of the parameter and its data type (16-bit or 32-bit integer or REAL).

### ControlLogix Controller – Explanation of Request and Response Data for Read/Write Multiple Messaging Using RSLogix 5000 Software, Any Version

The data structures in [Figure 6.10](#) and [Figure 6.11](#) use 16-bit words and can accommodate up to 22 parameters in a single message. In the Response Message, a parameter number with the high bit set indicates that the associated parameter value field contains an error code (parameter number in response data will be negative).

**Important:** See [Table 6.A on page 6-2](#) for limitations of PowerFlex 7-Class and PowerFlex 750-Series drives when using Class code 0x93 or Class code 0x9F for explicit messaging.

**Figure 6.10 Data Structures for Scattered Read Messages**

Request (Source Data)		Response (Destination Data)	
Word 0	Parameter Number	Word 0	Parameter Number
1	Pad Word	1	Parameter Value LSW
2	Pad Word	2	Parameter Value MSW
3	Parameter Number	3	Parameter Number
4	Pad Word	4	Parameter Value LSW
5	Pad Word	5	Parameter Value MSW
6	Parameter Number	6	Parameter Number
7	Pad Word	7	Parameter Value LSW
8	Pad Word	8	Parameter Value MSW
9	Parameter Number	9	Parameter Number
10	Pad Word	10	Parameter Value LSW
11	Pad Word	11	Parameter Value MSW
12	Parameter Number	12	Parameter Number
13	Pad Word	13	Parameter Value LSW
14	Pad Word	14	Parameter Value MSW
:		:	
63	Parameter Number	63	Parameter Number
64	Pad Word	64	Parameter Value LSW
65	Pad Word	65	Parameter Value MSW

**Figure 6.11 Data Structures for Scattered Write Messages**

Request (Source Data)		Response (Destination Data)	
Word 0	Parameter Number	Word 0	Parameter Number
1	Parameter Value LSW	1	Pad Word
2	Parameter Value MSW	2	Pad Word
3	Parameter Number	3	Parameter Number
4	Parameter Value LSW	4	Pad Word
5	Parameter Value MSW	5	Pad Word
6	Parameter Number	6	Parameter Number
7	Parameter Value LSW	7	Pad Word
8	Parameter Value MSW	8	Pad Word
9	Parameter Number	9	Parameter Number
10	Parameter Value LSW	10	Pad Word
11	Parameter Value MSW	11	Pad Word
12	Parameter Number	12	Parameter Number
13	Parameter Value LSW	13	Pad Word
14	Parameter Value MSW	14	Pad Word
:		:	
63	Parameter Number	63	Parameter Number
64	Parameter Value LSW	64	Pad Word
65	Parameter Value MSW	65	Pad Word

## Read Multiple Parameters

ControlLogix Controller Example Ladder Logic Program to Read Multiple Parameters Using RSLogix 5000 Software, Any Version

A Scattered Read message is used to read the values of multiple parameters. Up to 22 parameters can be read. This read message example reads the values of these five parameters.

PowerFlex 7-Class Drive	PowerFlex 750-Series Drive
<ul style="list-style-type: none"> <li>Parameter 001 - [Output Freq]</li> <li>Parameter 003 - [Output Current]</li> <li>Parameter 006 - [Output Voltage]</li> <li>Parameter 012 - [DC Bus Voltage]</li> <li>Parameter 017 - [Analog In1 Value]</li> </ul>	<ul style="list-style-type: none"> <li>Parameter 001 - [Output Freq]</li> <li>Parameter 007 - [Output Current]</li> <li>Parameter 137 - [Open Loop Fdbk]</li> <li>Parameter 21581 - [Port 5: Analog Out 0 Data]</li> <li>Parameter 260 - [Analog In0 Value]</li> </ul>

See [DPI Parameter Object on page C-16](#) (Class code 0x93) or [Host DPI Parameter Object on page C-30](#) (Class code 0x9F) for parameter numbering.

**Important:** See [Table 6.A on page 6-2](#) for limitations of PowerFlex 7-Class and PowerFlex 750-Series drives when using DPI Parameter Object Class code 0x93 or Host DPI Parameter Object Class code 0x9F for explicit messaging.

**Table 6.F Example Controller Tags to Read Multiple Parameters**

Operand	Controller Tags for Read Multiple Message	Data Type
XIC	Execute_Scattered_Read_Message	BOOL
MSG	Scattered_Read_Message	MESSAGE

**Figure 6.12 Example Ladder Logic to Read Multiple Parameters**



## ControlLogix Controller – Formatting a Message to Read Multiple Parameters Using RSLogix 5000 Software, Any Version

**Figure 6.13 Scattered Read Message Configuration Screens**

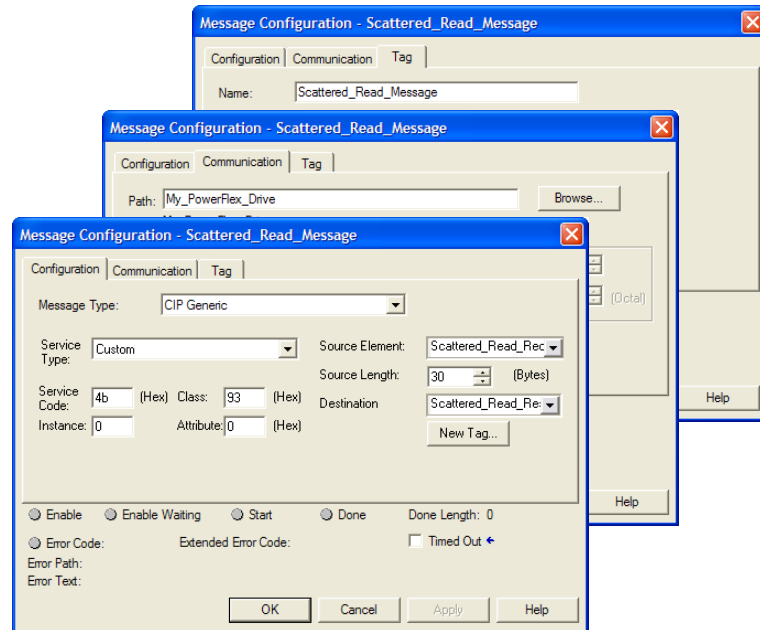

The following table identifies the data that is required in each box to configure a message to read multiple parameters.

Configuration Tab	Example Value	Description
Message Type	CIP Generic	Used to access Parameter Object in the adapter.
Service Type <sup>(1)</sup>	Custom	Required for scattered messages.
Service Code <sup>(1)</sup>	4b (Hex.)	Code for the requested service.
Class	93 or 9F (Hex.) <sup>(3)</sup>	Class ID for the DPI Parameter Object.
Instance	0 (Dec.)	Required for scattered messages.
Attribute	0 (Hex.)	Required for scattered messages.
Source Element	Scattered_Read_Request <sup>(4)</sup>	Name of the tag for any service data to be sent from scanner or bridge to the adapter/drive.
Source Length	30 <sup>(4)</sup>	Number of bytes of service data to be sent in the message.
Destination	Scattered_Read_Response	The tag where the data that is read is stored.
Communication Tab	Example Value	Description
Path <sup>(2)</sup>	My_PowerFlex_Drive	The path is the route that the message will follow.
Tag Tab	Example Value	Description
Name	Scattered_Read_Message	The name for the message.

<sup>(1)</sup> The default setting for Service Type is 'Custom', enabling entry of a Service Code not available from the Service Type pull-down menu. When choosing a Service Type other than 'Custom' from the pull-down menu, an appropriate Hex. value is automatically assigned to the Service Code box which is dimmed (unavailable).

<sup>(2)</sup> Click **Browse** to find the path, or type in the name of the device listed in the I/O Configuration folder.

<sup>(3)</sup> See [Table 6.A on page 6-2](#) for limitations of PowerFlex 7-Class and PowerFlex 750-Series drives when using DPI Parameter Object Class code 0x93 or Host DPI Parameter Object Class code 0x9F for explicit messaging.

<sup>(4)</sup> In this example, we are reading five parameters. Each parameter being read requires an array of three INT registers. Therefore, a controller tag was created with its Data Type field set to 'INT[15]'. Also, the Source Length field on the Message Configuration screen must correspond to the selected Data Type in bytes (for this example, 30 bytes for an INT[15] array). Scattered read messages always assume that every parameter being read is a 32-bit integer, regardless of its actual data type. Maximum length is 132 bytes or 66 words which equates to 22 parameters. For parameter numbering, see [DPI Parameter Object on page C-16](#) (Class code 0x93) or [Host DPI Parameter Object on page C-30](#) (Class code 0x9F).

## ControlLogix Controller Example Scattered Read Request Data

In this message example, we use the data structure in [Figure 6.14](#) or [Figure 6.15](#) in the source tag named Scattered\_Read\_Request to read these five parameters.

**PowerFlex 7-Class Drive**

- Parameter 001 - [Output Freq]
- Parameter 003 - [Output Current]
- Parameter 006 - [Output Voltage]
- Parameter 012 - [DC Bus Voltage]
- Parameter 017 - [Analog In1 Value]

**PowerFlex 750-Series Drive**

- Parameter 001 - [Output Freq]
- Parameter 007 - [Output Current]
- Parameter 137 - [Open Loop Fdbk]
- Parameter 21581 - [Port 5: Analog Out 0 Data]
- Parameter 260 - [Analog In0 Value]

See [DPI Parameter Object on page C-16](#) (Class code 0x93) or [Host DPI Parameter Object on page C-30](#) (Class code 0x9F) for parameter numbering.

**Figure 6.14 Example Scattered Read Request Data for PowerFlex 7-Class Drive**

Name	Δ	Value	←	Data Type	Description
[-] Scattered_Read_Request		{ . . . }		INT[15]	
[+] Scattered_Read_Request[0]		1		INT	Parameter Number (decimal)
[+] Scattered_Read_Request[1]		0		INT	Pad Word
[+] Scattered_Read_Request[2]		0		INT	Pad Word
[+] Scattered_Read_Request[3]		3		INT	Parameter Number (decimal)
[+] Scattered_Read_Request[4]		0		INT	Pad Word
[+] Scattered_Read_Request[5]		0		INT	Pad Word
[+] Scattered_Read_Request[6]		6		INT	Parameter Number (decimal)
[+] Scattered_Read_Request[7]		0		INT	Pad Word
[+] Scattered_Read_Request[8]		0		INT	Pad Word
[+] Scattered_Read_Request[9]		12		INT	Parameter Number (decimal)
[+] Scattered_Read_Request[10]		0		INT	Pad Word
[+] Scattered_Read_Request[11]		0		INT	Pad Word
[+] Scattered_Read_Request[12]		17		INT	Parameter Number (decimal)
[+] Scattered_Read_Request[13]		0		INT	Pad Word
[+] Scattered_Read_Request[14]		0		INT	Pad Word

**Figure 6.15 Example Scattered Read Request Data for PowerFlex 750-Series Drive**

Name	Δ	Value	←	Data Type	Description
[-] Scattered_Read_Request		{ . . . }		INT[15]	
[+] Scattered_Read_Request[0]		1		INT	Parameter Number (decimal)
[+] Scattered_Read_Request[1]		0		INT	Pad Word
[+] Scattered_Read_Request[2]		0		INT	Pad Word
[+] Scattered_Read_Request[3]		7		INT	Parameter Number (decimal)
[+] Scattered_Read_Request[4]		0		INT	Pad Word
[+] Scattered_Read_Request[5]		0		INT	Pad Word
[+] Scattered_Read_Request[6]		137		INT	Parameter Number (decimal)
[+] Scattered_Read_Request[7]		0		INT	Pad Word
[+] Scattered_Read_Request[8]		0		INT	Pad Word
[+] Scattered_Read_Request[9]		21581		INT	Parameter Number (decimal)
[+] Scattered_Read_Request[10]		0		INT	Pad Word
[+] Scattered_Read_Request[11]		0		INT	Pad Word
[+] Scattered_Read_Request[12]		260		INT	Parameter Number (decimal)
[+] Scattered_Read_Request[13]		0		INT	Pad Word
[+] Scattered_Read_Request[14]		0		INT	Pad Word

### ControlLogix Controller Example Scattered Read Response Data

The Scattered Read Request message reads the multiple parameters and returns their values to the destination tag (Scattered\_Read\_Response). [Figure 6.16](#) or [Figure 6.17](#) shows the parameter values.

**Figure 6.16 Example Scattered Read Response Data for PowerFlex 7-Class Drive**

Name	Value	Data Type	Description
Scattered_Read_Response	{...}	INT[15]	
Scattered_Read_Response[0]	1	INT	Parameter Number (decimal)
Scattered_Read_Response[1]	325	INT	Parameter Value LSW
Scattered_Read_Response[2]	0	INT	Parameter Value MSW
Scattered_Read_Response[3]	3	INT	Parameter Number (decimal)
Scattered_Read_Response[4]	1	INT	Parameter Value LSW
Scattered_Read_Response[5]	0	INT	Parameter Value MSW
Scattered_Read_Response[6]	6	INT	Parameter Number (decimal)
Scattered_Read_Response[7]	1187	INT	Parameter Value LSW
Scattered_Read_Response[8]	0	INT	Parameter Value MSW
Scattered_Read_Response[9]	12	INT	Parameter Number (decimal)
Scattered_Read_Response[10]	3292	INT	Parameter Value LSW
Scattered_Read_Response[11]	0	INT	Parameter Value MSW
Scattered_Read_Response[12]	17	INT	Parameter Number (decimal)
Scattered_Read_Response[13]	8318	INT	Parameter Value LSW
Scattered_Read_Response[14]	0	INT	Parameter Value MSW

In this message example, the parameters have the following values.

PowerFlex 7-Class Drive Parameter	Read Value
1 - [Output Freq]	32.5 Hz
3 - [Output Current]	0.01 Amp
6 - [Output Voltage]	118.7V AC
12 - [DC Bus Voltage]	329.2V DC
17 - [Analog In2 Value]	8.318 mA

**Figure 6.17 Example Scattered Read Response Data for PowerFlex 750-Series Drive**

Name	Value	Data Type	Description
Scattered_Read_Response	{...}	INT[15]	
Scattered_Read_Response[0]	1	INT	Parameter Number (decimal)
Scattered_Read_Response[1]	0	INT	Parameter Value LSW
Scattered_Read_Response[2]	16948	INT	Parameter Value MSW
Scattered_Read_Response[3]	7	INT	Parameter Number (decimal)
Scattered_Read_Response[4]	-15729	INT	Parameter Value LSW
Scattered_Read_Response[5]	15605	INT	Parameter Value MSW
Scattered_Read_Response[6]	137	INT	Parameter Number (decimal)
Scattered_Read_Response[7]	23698	INT	Parameter Value LSW
Scattered_Read_Response[8]	26035	INT	Parameter Value MSW
Scattered_Read_Response[9]	21581	INT	Parameter Number (decimal)
Scattered_Read_Response[10]	0	INT	Parameter Value LSW
Scattered_Read_Response[11]	16948	INT	Parameter Value MSW
Scattered_Read_Response[12]	260	INT	Parameter Number (decimal)
Scattered_Read_Response[13]	-9437	INT	Parameter Value LSW
Scattered_Read_Response[14]	16661	INT	Parameter Value MSW

The PowerFlex 750-Series drive uses 32-bit integer and REAL parameters. A COP command must be used to copy the Scattered\_Read\_Response integer array to a 32-bit integer or REAL tag. [Figure 6.18](#) shows the ladder logic used for this example. If the parameter data type is a REAL, then the destination tag is a REAL. If the parameter data type is a 32-bit integer, then the destination tag is a DINT. See the drive documentation to determine the parameter data type (32-bit integer or REAL).



**Figure 6.18 Example Ladder Logic to Copy Response Data for PowerFlex 750-Series Drive**

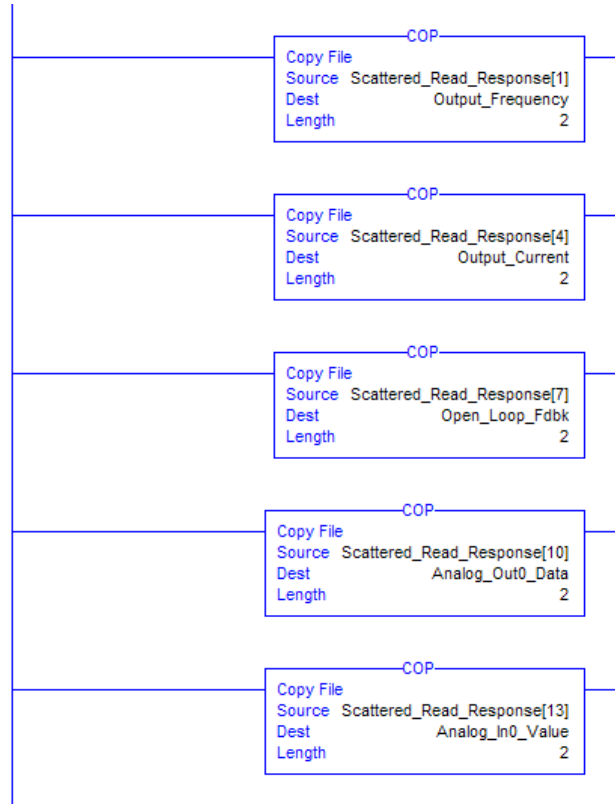

In this message example, the parameters have the following values.

PowerFlex 750-Series Drive Parameter	Read Value	Data Type
1 - [Output Freq]	45.0 Hz	REAL
7 - [Output Current]	0.03 Amp	REAL
137 - [Open Loop Fdbk]	1706253458	DINT
21581 - [Port 5: Analog Out 0 Data]	45.0 Hz	REAL
260 - [Analog In0 Value]	9.366 Volts	REAL

### Write Multiple Parameters

ControlLogix Controller Example Ladder Logic Program to Write Multiple Parameters Using RSLogix 5000 Software, Any Version

A Scattered Write message is used to write to multiple parameters. This write message example writes the following values to these five parameters.

PowerFlex 7-Class Drive Parameter	Write Value	PowerFlex 750-Series Drive Parameter	Write Value
141 - [Accel Time 2]	11.1 Sec.	536 - [Accel Time 2]	11.1 Sec.
143 - [Decel Time 2]	22.2 Sec.	538 - [Decel Time 2]	22.2 Sec.
105 - [Preset Speed 5]	33.3 Hz.	725 - [Zero Position]	33
106 - [Preset Speed 6]	44.4 Hz.	21555 - [Port 5: Analog In0 Hi]	5.5
107 - [Preset Speed 7]	55.5 Hz.	780 - [PTP Setpoint]	-75,555

See [DPI Parameter Object on page C-16](#) (Class code 0x93) or [Host DPI Parameter Object on page C-30](#) (Class code 0x9F) for parameter numbering.

**Important:** See [Table 6.A on page 6-2](#) for limitations of PowerFlex 7-Class and PowerFlex 750-Series drives when using DPI Parameter Object Class code 0x93 or Host DPI Parameter Object Class code 0x9F for explicit messaging.

**Table 6.G Example Controller Tags to Write Multiple Parameters**

Operand	Controller Tags for Write Multiple Message	Data Type
XIC	Execute_Scattered_Write_Message	BOOL
MSG	Scattered_Write_Message	MESSAGE

**Figure 6.19 Example Ladder Logic to Write Multiple Parameters**



**Important:** If the explicit message scattered write must be written continuously, then use a separate explicit message single write for each parameter using DPI Parameter Object Class code 0x93 or Host DPI Parameter Object Class code 0x9F and attribute A (10 decimal; see [page 6-11](#)). Attribute A writes to RAM—not NVS (EEPROM) memory. This example scattered write message using attribute 0 writes to NVS. Over time, continuous writes will exceed the EEPROM life cycle and cause the drive to malfunction.

## ControlLogix Controller – Formatting a Message to Write Multiple Parameters Using RSLogix 5000 Software, Any Version

**Figure 6.20 Scattered Write Multiple Message Configuration Screens**

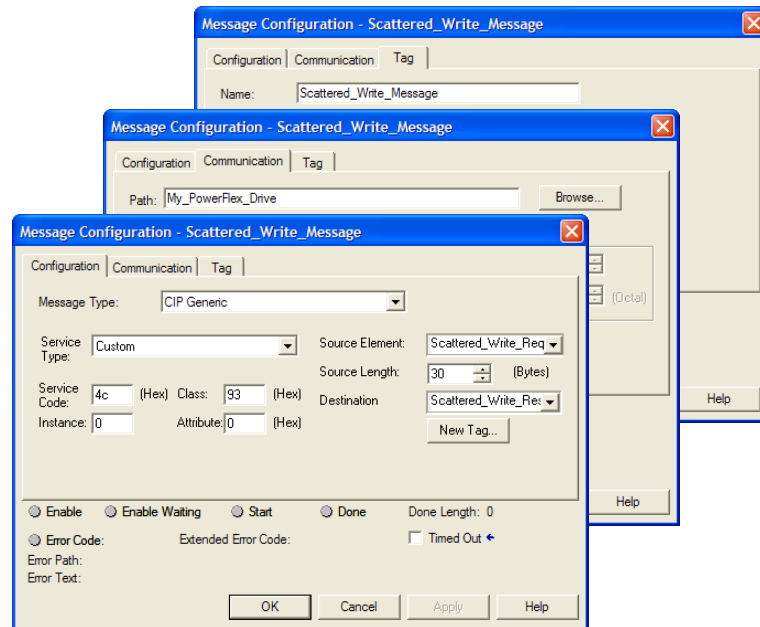

The following table identifies the data that is required in each box to configure a message to write multiple parameters.

Configuration Tab	Example Value	Description
Message Type	CIP Generic	Used to access Parameter Object in the adapter.
Service Type <sup>(1)</sup>	Custom	Required for scattered messages.
Service Code <sup>(1)</sup>	4c (Hex.)	Code for the requested service.
Class	93 or 9F (Hex.) <sup>(3)</sup>	Class ID for the DPI Parameter Object.
Instance	0 (Dec.)	Required for scattered messages.
Attribute	0 (Hex.)	Required for scattered messages.
Source Element	Scattered_Write_Request <sup>(4)</sup>	Name of the tag for any service data to be sent from scanner or bridge to the adapter/drive.
Source Length	30 <sup>(4)</sup>	Number of bytes of service data to be sent in the message.
Destination	Scattered_Write_Response	The tag where the data that is read is stored.
Communication Tab	Example Value	Description
Path <sup>(2)</sup>	My_PowerFlex_Drive	The path is the route that the message will follow.
Tag Tab	Example Value	Description
Name	Scattered_Write_Message	The name for the message.

<sup>(1)</sup> The default setting for Service Type is 'Custom', enabling entry of a Service Code not available from the Service Type pull-down menu. When choosing a Service Type other than 'Custom' from the pull-down menu, an appropriate Hex. value is automatically assigned to the Service Code box which is dimmed (unavailable).

<sup>(2)</sup> Click **Browse** to find the path, or type in the name of the device listed in the I/O Configuration folder.

<sup>(3)</sup> See [Table 6.A on page 6-2](#) for limitations of PowerFlex 7-Class and PowerFlex 750-Series drives when using DPI Parameter Object Class code 0x93 or Host DPI Parameter Object Class code 0x9F for explicit messaging.

<sup>(4)</sup> In this example, we are writing to five parameters. Each parameter being written to requires an array of three INT registers. Therefore, a controller tag was created with its Data Type field set to 'INT[15]'. Also, the Source Length field on the Message Configuration screen must correspond to the selected Data Type in bytes (for this example, 30 bytes for an INT[15] array). Scattered write messages always assume that every parameter being written to is a 32-bit integer, regardless of its actual data type. Maximum length is 132 bytes or 66 words which equates to 22 parameters. For parameter numbering, see [DPI Parameter Object on page C-16](#) (Class code 0x93) or [Host DPI Parameter Object on page C-30](#) (Class code 0x9F).

### ControlLogix Controller Example Scattered Write Request Data

In this message example, we use the data structure in [Figure 6.21](#) or [Figure 6.24](#) in the source tag (Scattered\_Write\_Request) to write new values to these parameters.

PowerFlex 7-Class Drive Parameter	Write Value	PowerFlex 750-Series Drive Parameter	Write Value	Data Type
141 - [Accel Time 2]	11.1 Sec.	536 - [Accel Time 2]	11.1 Sec.	REAL
143 - [Decel Time 2]	22.2 Sec.	538 - [Decel Time 2]	22.2 Sec.	REAL
105 - [Preset Speed 5]	33.3 Hz.	725 - [Zero Position]	33	DINT
106 - [Preset Speed 6]	44.4 Hz.	21555 - [Port 5: Analog In0 Hi]	5.5	REAL
107 - [Preset Speed 7]	55.5 Hz.	780 - [PTP Setpoint]	-75,555	REAL

See [DPI Parameter Object on page C-16](#) (Class code 0x93) or [Host DPI Parameter Object on page C-30](#) (Class code 0x9F) for parameter numbering.

[Figure 6.21](#) or [Figure 6.24](#) shows the parameter values.

**Figure 6.21 Example Scattered Write Request Data for PowerFlex 7-Class Drive**

Name	Value	Data Type	Description
Scattered_Write_Request	{...}	INT[15]	
Scattered_Write_Request[0]	141	INT	Parameter Number (decimal)
Scattered_Write_Request[1]	111	INT	Parameter Value LS'W
Scattered_Write_Request[2]	0	INT	Parameter Value MS'W
Scattered_Write_Request[3]	143	INT	Parameter Number (decimal)
Scattered_Write_Request[4]	222	INT	Parameter Value LS'W
Scattered_Write_Request[5]	0	INT	Parameter Value MS'W
Scattered_Write_Request[6]	105	INT	Parameter Number (decimal)
Scattered_Write_Request[7]	333	INT	Parameter Value LS'W
Scattered_Write_Request[8]	0	INT	Parameter Value MS'W
Scattered_Write_Request[9]	106	INT	Parameter Number (decimal)
Scattered_Write_Request[10]	444	INT	Parameter Value LS'W
Scattered_Write_Request[11]	0	INT	Parameter Value MS'W
Scattered_Write_Request[12]	107	INT	Parameter Number (decimal)
Scattered_Write_Request[13]	555	INT	Parameter Value LS'W
Scattered_Write_Request[14]	0	INT	Parameter Value MS'W

### ControlLogix Controller Example Scattered Write Response Data

The results of the message appear in the destination tag named Scattered\_Write\_Response ([Figure 6.22](#)). Values of '0' indicate no errors occurred.

Figure 6.22 Example Scattered Write Response Data for PowerFlex 7-Class Drive

Name	Value	Data Type	Description
Scattered_Write_Response	{...}	INT[15]	
Scattered_Write_Response[0]	141	INT	Parameter Number (decimal)
Scattered_Write_Response[1]	0	INT	Pad Word or Error Code
Scattered_Write_Response[2]	0	INT	Pad Word
Scattered_Write_Response[3]	143	INT	Parameter Number (decimal)
Scattered_Write_Response[4]	0	INT	Pad Word or Error Code
Scattered_Write_Response[5]	0	INT	Pad Word
Scattered_Write_Response[6]	105	INT	Parameter Number (decimal)
Scattered_Write_Response[7]	0	INT	Pad Word or Error Code
Scattered_Write_Response[8]	0	INT	Pad Word
Scattered_Write_Response[9]	106	INT	Parameter Number (decimal)
Scattered_Write_Response[10]	0	INT	Pad Word or Error Code
Scattered_Write_Response[11]	0	INT	Pad Word
Scattered_Write_Response[12]	107	INT	Parameter Number (decimal)
Scattered_Write_Response[13]	0	INT	Pad Word or Error Code
Scattered_Write_Response[14]	0	INT	Pad Word

The PowerFlex 750-Series drive uses 32-bit integer and REAL parameters. A COP command must be used to copy the 32-bit integer and REAL values to the Scattered\_Write\_Request integer array. Figure 6.23 shows the ladder logic used for this example. If the parameter data type is a REAL, then the source tag is a REAL. If the parameter data type is a 32-bit integer, then the source tag is a DINT. See the drive documentation to determine the parameter data type (32-bit integer or REAL).

Figure 6.23 Example Ladder Logic to Copy Request Data for PowerFlex 750-Series Drive

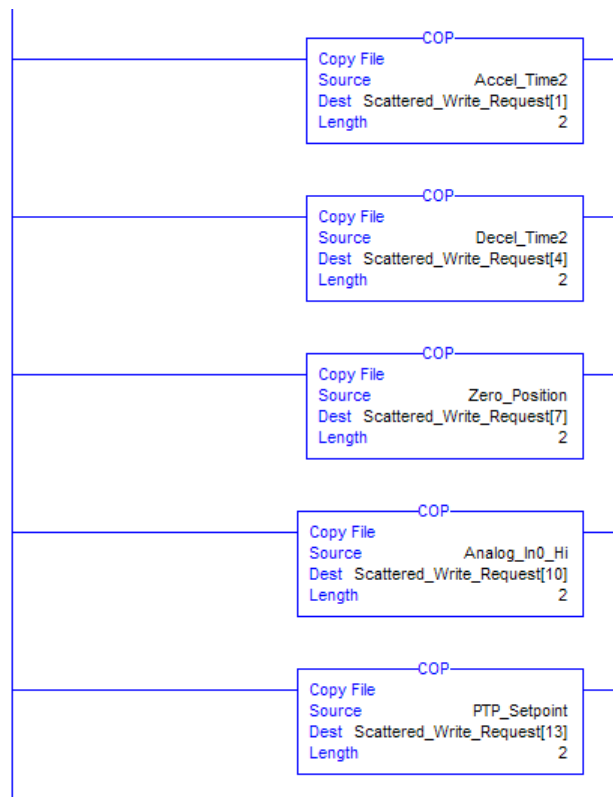

**Figure 6.24 Example Scattered Write Request Data for PowerFlex 750-Series Drive**

Name	Value	Data Type	Description
Scattered_Write_Request	{ ... }	INT[15]	
+ Scattered_Write_Request[0]	536	INT	Parameter Number (decimal)
+ Scattered_Write_Request[1]	-26214	INT	Parameter Value LSW
+ Scattered_Write_Request[2]	16689	INT	Parameter Value MSW
+ Scattered_Write_Request[3]	538	INT	Parameter Number (decimal)
+ Scattered_Write_Request[4]	-26214	INT	Parameter Value LSW
+ Scattered_Write_Request[5]	16817	INT	Parameter Value MSW
+ Scattered_Write_Request[6]	725	INT	Parameter Number (decimal)
+ Scattered_Write_Request[7]	33	INT	Parameter Value LSW
+ Scattered_Write_Request[8]	0	INT	Parameter Value MSW
+ Scattered_Write_Request[9]	21555	INT	Parameter Number (decimal)
+ Scattered_Write_Request[10]	0	INT	Parameter Value LSW
+ Scattered_Write_Request[11]	16560	INT	Parameter Value MSW
+ Scattered_Write_Request[12]	780	INT	Parameter Number (decimal)
+ Scattered_Write_Request[13]	-10019	INT	Parameter Value LSW
+ Scattered_Write_Request[14]	-2	INT	Parameter Value MSW

The results of the explicit message appear in the destination tag Scattered\_Write\_Response (Figure 6.25). Values of '0' indicate no errors occurred.

**Figure 6.25 Example Scattered Write Response Data for PowerFlex 750-Series Drive**

Name	Value	Data Type	Description
Scattered_Write_Response	{ ... }	INT[15]	
+ Scattered_Write_Response[0]	536	INT	Parameter Number (decimal)
+ Scattered_Write_Response[1]	0	INT	Pad Word or Error Code
+ Scattered_Write_Response[2]	0	INT	Pad Word
+ Scattered_Write_Response[3]	538	INT	Parameter Number (decimal)
+ Scattered_Write_Response[4]	0	INT	Pad Word or Error Code
+ Scattered_Write_Response[5]	0	INT	Pad Word
+ Scattered_Write_Response[6]	725	INT	Parameter Number (decimal)
+ Scattered_Write_Response[7]	0	INT	Pad Word or Error Code
+ Scattered_Write_Response[8]	0	INT	Pad Word
+ Scattered_Write_Response[9]	21555	INT	Parameter Number (decimal)
+ Scattered_Write_Response[10]	0	INT	Pad Word or Error Code
+ Scattered_Write_Response[11]	0	INT	Pad Word
+ Scattered_Write_Response[12]	780	INT	Parameter Number (decimal)
+ Scattered_Write_Response[13]	0	INT	Pad Word or Error Code
+ Scattered_Write_Response[14]	0	INT	Pad Word

## PLC-5 Controller Examples

The ControlNet I/O Transfer (CIO) instruction is used to send explicit messages. For PLC-5/xxC controllers, Series F, revision B or earlier, the available services you should use are Get Attribute Single, Get Attribute All, Set Attribute Single, or Set Attribute All using a CIP Generic communication command. PLC-5/xxC controllers, Series F, revision C or later, provide available message services for Get Attributes Scattered and Set Attributes Scattered using a Generic Bi-Directional communication command.

### PLC-5 Controller Example Ladder Logic Program to Read a Single Parameter

A read message is used to read a single parameter. The specific N40:0 address shown in this read message example reads the value of parameter 003 - [Output Current] in a PowerFlex 7-Class drive.

**Figure 6.26 Example Ladder Logic to Read a Single Parameter**

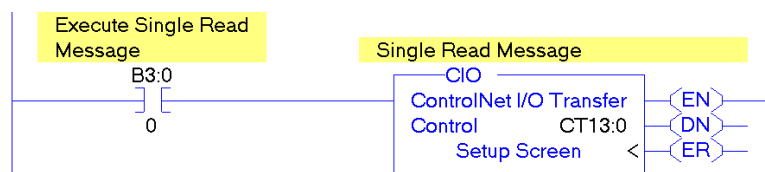

## PLC-5 Controller – Formatting a Message to Read a Single Parameter

Figure 6.27 Read Single Message Configuration Screen

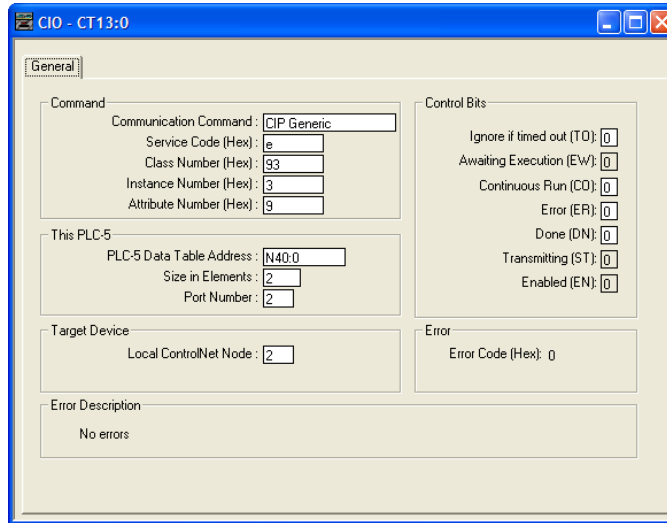

The following table identifies the data that is required in each box to configure a message to read a single parameter.

General Tab	Example Value	Description
Communication Command	CIP Generic	Command type for controller to read data from the drive.
Service Code	e (Hex.)	Code for the requested service.
Class Number	93 or 9F (Hex.) <sup>(2)</sup>	Class ID for the DPI Parameter Object.
Instance Number <sup>(1)</sup>	3 (Hex.)	Instance number is the same as parameter number.
Attribute Number	9 (Hex.)	Attribute number for the Parameter Value attribute.
PLC-5 Data Table Address	N40:0 <sup>(3)</sup>	An unused controller data table address containing the message instruction. This address is the starting word of the destination file.
Size in Elements	2 <sup>(3)</sup>	Number of elements (words) to be transferred. Each element size is a 16-bit integer.
Port Number	2	Controller port to which the network is connected.
Local ControlNet Node	2	The node address of the adapter connected to the drive.

<sup>(1)</sup> The instance is the parameter number in the drive (Port 0). To read a parameter in another port, see [DPI Parameter Object on page C-16](#) (Class code 0x93) or [Host DPI Parameter Object on page C-30](#) (Class code 0x9F) to determine the instance number. For example, to read parameter 4 of a peripheral in Port 5 of a PowerFlex 750-Series drive, the instance would be 21504 + 4 = 21508 or 5404 (Hex).

<sup>(2)</sup> See [Table 6.A on page 6-2](#) for limitations of PowerFlex 7-Class and PowerFlex 750-Series drives when using DPI Parameter Object Class code 0x93 or Host DPI Parameter Object Class code 0x9F for explicit messaging.

<sup>(3)</sup> In this example, Output Current is a 32-bit integer parameter requiring the Size in Elements field to be set to '2'. If the parameter being read is a 16-bit integer, the Size in Elements must be set to '1'. When using a PowerFlex 700S or PowerFlex 750-Series drive, Output Current is a REAL (floating point) parameter. You must still write this data to an integer file with Size in Elements set to '2'. The following page shows ladder logic to convert the data into a floating point.



### PLC-5 Controller Example Single Read Response Data

In this specific N40:0 message example, we use the data table address in [Figure 6.28](#) to store the response value (0.13 amps) that was read from drive parameter 003 - [Output Current]. To determine the data type for the parameter and its required scaling, see the specific drive documentation.

**Figure 6.28 Example Single Read Response Data File**

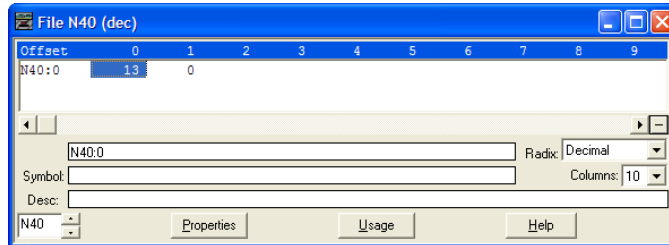

[Figure 6.29](#) shows example ladder logic to correctly format the three possible data types for read messages of different parameter types in the PLC-5 controller.

**Figure 6.29 Example Ladder Logic to Format Parameter Data Types for Reads**

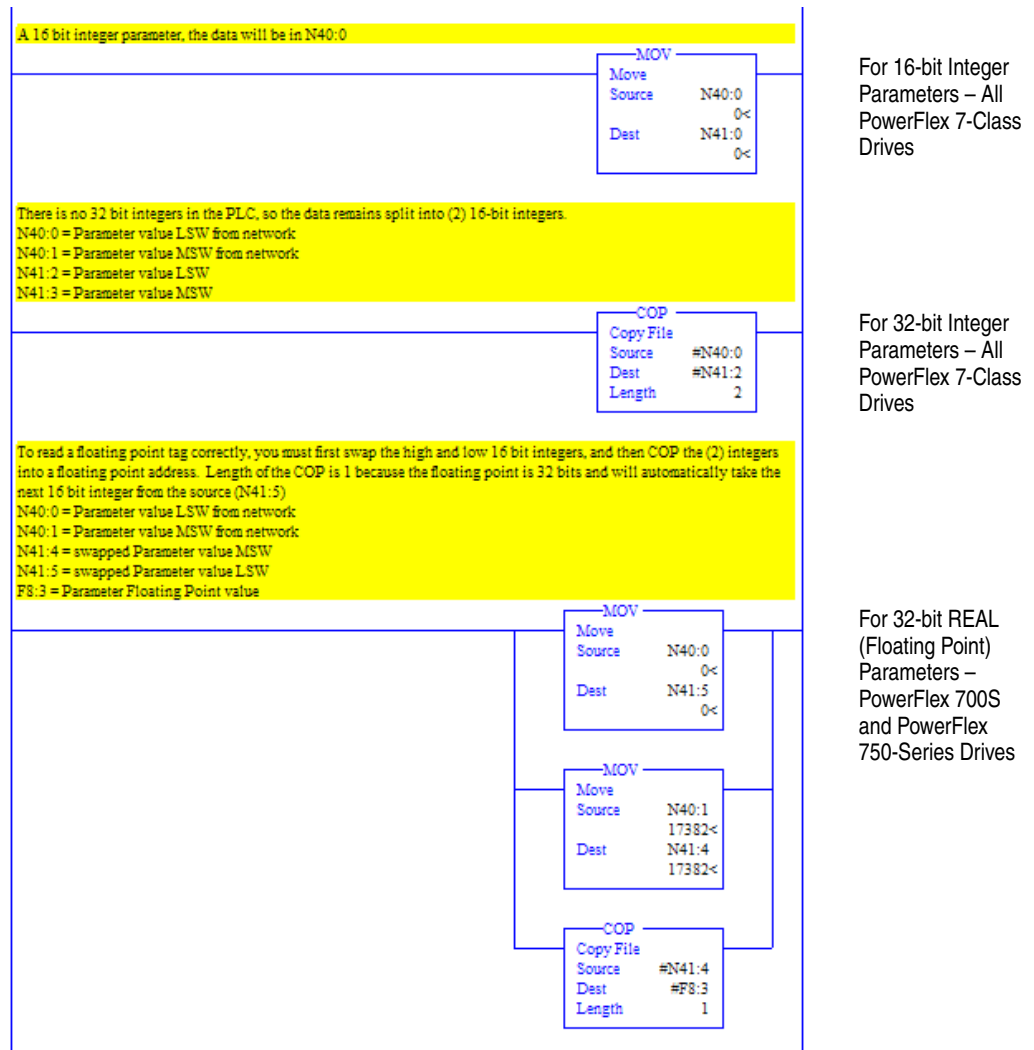

### PLC-5 Controller Example Ladder Logic Program to Write a Single Parameter

A write message is used to write to a single parameter. The specific N50:0 address shown in this write message example writes a value to parameter 140 - [Accel Time 1] in a PowerFlex 7-Class drive.

Figure 6.30 Example Ladder Logic to Write a Single Parameter

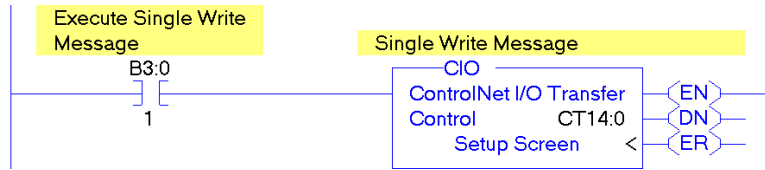

## PLC-5 Controller – Formatting a Message to Write a Single Parameter

Figure 6.31 Write Single Message Configuration Screen

The following table identifies the data that is required in each box to configure a message to write a single parameter.

General Tab	Example Value	Description
Communication Command	CIP Generic	Command type for controller to write data to the drive.
Service Code	10 (Hex.)	Code for the requested service.
Class Number	93 or 9F (Hex.) <sup>(3)</sup>	Class ID for the DPI Parameter Object.
Instance Number <sup>(1)</sup>	8c (Hex.)	Instance number is the same as parameter number.
Attribute Number <sup>(2)</sup>	9 or A (Hex.)	Attribute number for the Parameter Value attribute.
PLC-5 Data Table Address	N50:0 <sup>(4)</sup>	An unused controller data table address containing the message instruction. This address is the starting word of the source file.
Size in Elements	1 <sup>(4)</sup>	Number of elements (words) to be transferred. Each element size is a 16-bit integer.
Port Number	2	Controller port to which the ControlNet network is connected.
Local ControlNet Node	2	The node address of the adapter connected to the drive.

<sup>(1)</sup> The instance is the parameter number in the drive (Port 0). To write to a parameter in another port, see [DPI Parameter Object on page C-16](#) (Class code 0x93) or [Host DPI Parameter Object on page C-30](#) (Class code 0x9F) to determine the instance number. For example, to write to parameter 51 of a peripheral in Port 5 of a PowerFlex 750-Series drive, the instance would be 21504 + 51 = 21555 or 5433 (Hex). In this example, Accel Time 1 is parameter 140 or 8C (Hex.).

<sup>(2)</sup> Setting the Attribute value to '9' will write the parameter value to the drive's Nonvolatile Storage (EEPROM) memory, which retains the parameter value even after the drive is power cycled. **Important:** When set to '9', the EEPROM may quickly exceed its life cycle and cause the drive to malfunction. Setting the Attribute value to 'A' will write the parameter value to temporary memory, which deletes the parameter value after the drive is power cycled. When frequent write messages are required, we recommend using the 'A' setting.

<sup>(3)</sup> See [Table 6.A on page 6-2](#) for limitations of PowerFlex 7-Class and PowerFlex 750-Series drives when using DPI Parameter Object Class code 0x93 or Host DPI Parameter Object Class code 0x9F for explicit messaging.

<sup>(4)</sup> In this example, Accel Time 1 is a 16-bit integer parameter requiring the Size in Elements field to be set to '1'. If the parameter being written to is a 32-bit integer, the Size in Elements must be set to '2'. When using a PowerFlex 700S or PowerFlex 750-Series drive, Accel Time 1 is a REAL (floating point) parameter. You must still write this data to an integer file with Size in Elements set to '2'. The following page shows ladder logic to convert floating point data into integer files.

### PLC-5 Controller Example Single Write Response Data

In this specific N50:0 message example, we use the data table address in [Figure 6.32](#) to store the request value (10.0 sec.) that was written to drive parameter 140 - [Accel Time 1]. To determine the data type for the parameter and its required scaling, see the specific drive documentation.

**Figure 6.32 Example Single Write Response Data File**

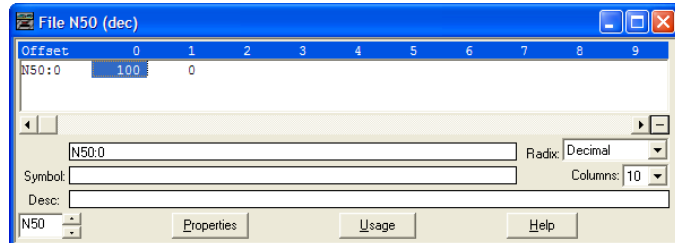

[Figure 6.33](#) shows example ladder logic to correctly format the three possible data types for write messages of different parameter types in the PLC-5 controller.

**Figure 6.33 Example Ladder Logic to Format Parameter Data Types for Writes**

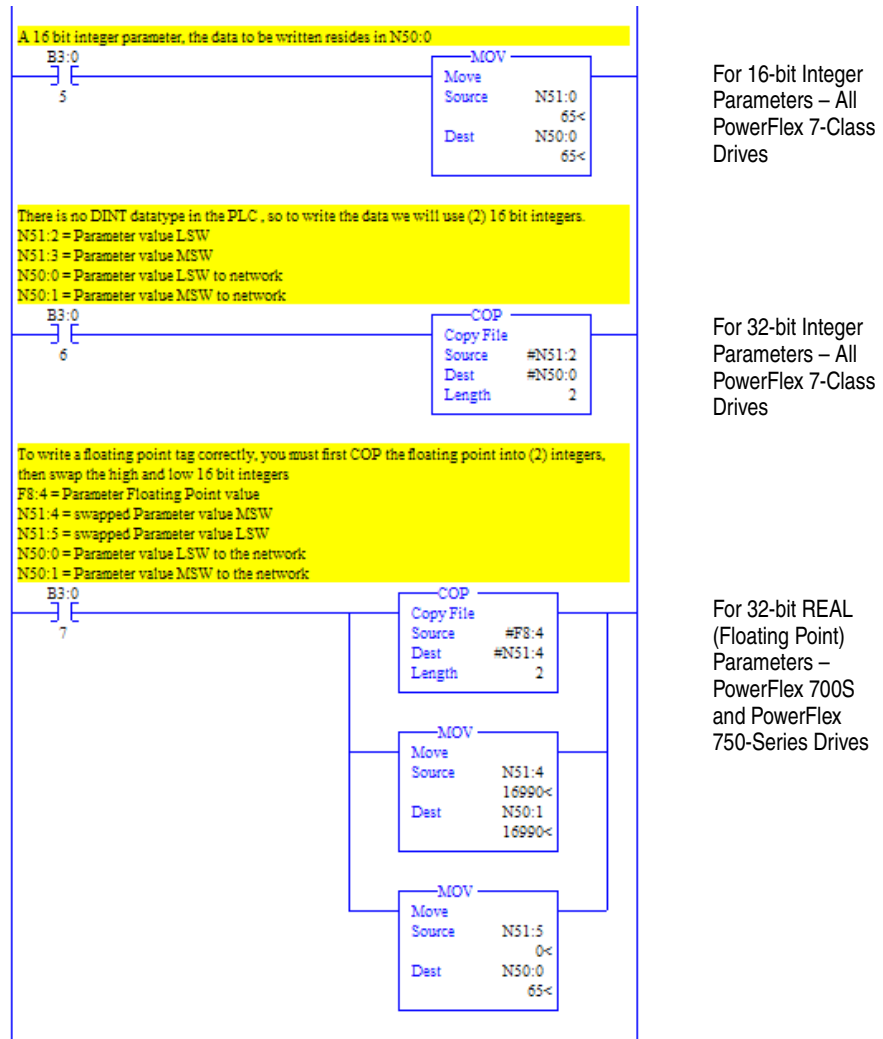

## PLC-5 Controller – Explanation of Request and Response Data for Read/Write Multiple Messaging

The data structures in [Figure 6.34](#) and [Figure 6.35](#) use 16-bit words and can accommodate up to 22 parameters in a single message. In the Response Message, a parameter number with the high bit set indicates that the associated parameter value field contains an error code (parameter number in response data will be negative).

**Important:** See [Table 6.A on page 6-2](#) for limitations of PowerFlex 7-Class and PowerFlex 750-Series drives when using Class code 0x93 or Class code 0x9F for explicit messaging.

**Figure 6.34 Data Structures for Scattered Read Messages**

Request (Source Data)		Response (Destination Data)	
Word 0	Parameter Number	Word 0	Parameter Number
1	Pad Word	1	Parameter Value LSW
2	Pad Word	2	Parameter Value MSW
3	Parameter Number	3	Parameter Number
4	Pad Word	4	Parameter Value LSW
5	Pad Word	5	Parameter Value MSW
6	Parameter Number	6	Parameter Number
7	Pad Word	7	Parameter Value LSW
8	Pad Word	8	Parameter Value MSW
9	Parameter Number	9	Parameter Number
10	Pad Word	10	Parameter Value LSW
11	Pad Word	11	Parameter Value MSW
12	Parameter Number	12	Parameter Number
13	Pad Word	13	Parameter Value LSW
14	Pad Word	14	Parameter Value MSW
:		:	
63	Parameter Number	63	Parameter Number
64	Pad Word	64	Parameter Value LSW
65	Pad Word	65	Parameter Value MSW

**Figure 6.35 Data Structures for Scattered Write Messages**

Request (Source Data)		Response (Destination Data)	
Word 0	Parameter Number	Word 0	Parameter Number
1	Parameter Value LSW	1	Pad Word
2	Parameter Value MSW	2	Pad Word
3	Parameter Number	3	Parameter Number
4	Parameter Value LSW	4	Pad Word
5	Parameter Value MSW	5	Pad Word
6	Parameter Number	6	Parameter Number
7	Parameter Value LSW	7	Pad Word
8	Parameter Value MSW	8	Pad Word
9	Parameter Number	9	Parameter Number
10	Parameter Value LSW	10	Pad Word
11	Parameter Value MSW	11	Pad Word
12	Parameter Number	12	Parameter Number
13	Parameter Value LSW	13	Pad Word
14	Parameter Value MSW	14	Pad Word
:		:	
63	Parameter Number	63	Parameter Number
64	Parameter Value LSW	64	Pad Word
65	Parameter Value MSW	65	Pad Word

### PLC-5 Controller Example Ladder Logic Program to Read Multiple Parameters

A Generic Bi-Directional scattered read message is used to read the values of multiple parameters. This read message example reads the values of these five parameters.

PowerFlex 7-Class Drive	PowerFlex 750-Series Drive
<ul style="list-style-type: none"> <li>• Parameter 001 - [Output Freq]</li> <li>• Parameter 003 - [Output Current]</li> <li>• Parameter 006 - [Output Voltage]</li> <li>• Parameter 012 - [DC Bus Voltage]</li> <li>• Parameter 017 - [Analog In1 Value]</li> </ul>	<ul style="list-style-type: none"> <li>• Parameter 001 - [Output Freq]</li> <li>• Parameter 007 - [Output Current]</li> <li>• Parameter 137 - [Open Loop Fdbk]</li> <li>• Parameter 21581 - [Port 5: Analog Out 0 Data]</li> <li>• Parameter 260 - [Analog In0 Value]</li> </ul>

See [DPI Parameter Object on page C-16](#) (Class code 0x93) or [Host DPI Parameter Object on page C-30](#) (Class code 0x9F) for parameter numbering.

**Important:** See [Table 6.A on page 6-2](#) for limitations of PowerFlex 7-Class and PowerFlex 750-Series drives when using DPI Parameter Object Class code 0x93 or Host DPI Parameter Object Class code 0x9F for explicit messaging.

**Figure 6.36 Example Ladder Logic to Read Multiple Parameters**

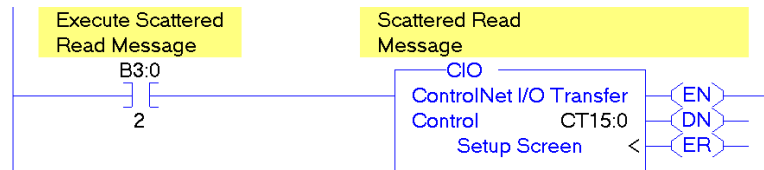

## PLC-5 Controller – Formatting a Message to Read Multiple Parameters

Figure 6.37 Scattered Read Message Configuration Screens

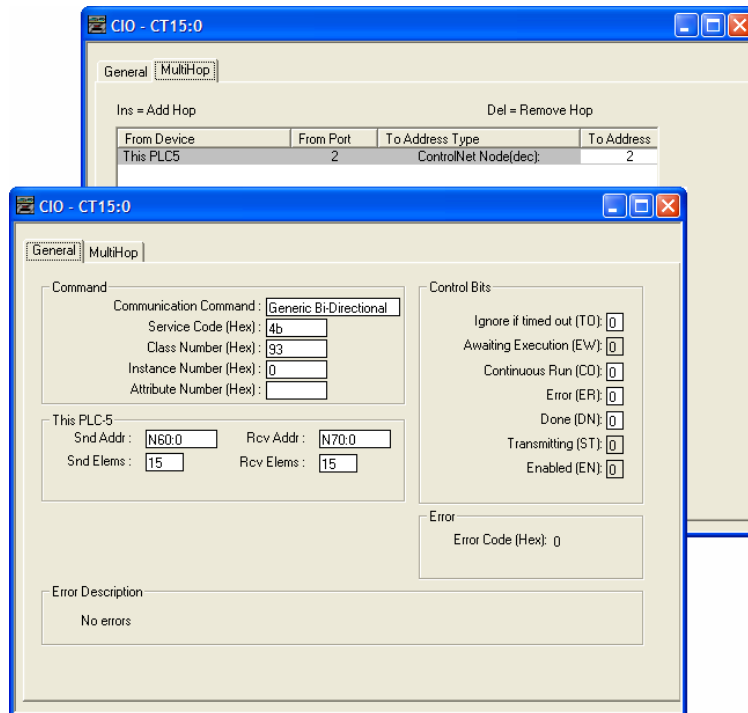

The following table identifies the data that is required in each box to configure a message to read multiple parameters.

General Tab	Example Value	Description
Communication Command	Generic Bi-Directional	Command type for the controller to read multiple data from the drive.
Service Code	4b (Hex.)	Code for the requested service.
Class Number	93 or 9F (Hex.) <sup>(1)</sup>	Class ID for the DPI Parameter Object.
Instance Number	0 (Hex.)	Required for scattered messages.
Attribute Number	—	Not used.
Snd Addr	N60:0	An unused controller data table address containing the message instruction. This address is the starting word of the source file.
Snd Elems	15 <sup>(2)</sup>	Number of elements (words) to be transferred. Each element size is a 16-bit integer.
Rcv Addr	N70:0	An unused controller data table address containing the message instruction. This address is the starting word of the destination file.
Rcv Elems	15 <sup>(2)</sup>	Number of elements (words) to be transferred. Each element size is a 16-bit integer.
MultiHop Tab	Example Value	Description
To Address	2	The node address of the adapter connected to the drive.

<sup>(1)</sup> See [Table 6.A on page 6-2](#) for limitations of PowerFlex 7-Class and PowerFlex 750-Series drives when using DPI Parameter Object Class code 0x93 or Host DPI Parameter Object Class code 0x9F for explicit messaging.

<sup>(2)</sup> In this example, we are reading five parameters. Each parameter being read requires three contiguous 16-bit words. Scattered read messages always assume that every parameter being read is a 32-bit integer, regardless of its actual data type. The data structure format is the same as shown on [page 6-29](#). Maximum length is 66 words, which equates to 22 parameters. For parameter numbering, see [DPI Parameter Object on page C-16](#) (Class code 0x93) or [Host DPI Parameter Object on page C-30](#) (Class code 0x9F).

### PLC-5 Controller Example Scattered Read Request Data

In this message example, we use the data table addresses in [Figure 6.38](#) or [Figure 6.39](#) to store the request values to be read from these drive parameters.

PowerFlex 7-Class Drive	PowerFlex 750-Series Drive
<ul style="list-style-type: none"> <li>Parameter 001 - [Output Freq]</li> <li>Parameter 003 - [Output Current]</li> <li>Parameter 006 - [Output Voltage]</li> <li>Parameter 012 - [DC Bus Voltage]</li> <li>Parameter 017 - [Analog In1 Value]</li> </ul>	<ul style="list-style-type: none"> <li>Parameter 001 - [Output Freq]</li> <li>Parameter 007 - [Output Current]</li> <li>Parameter 137 - [Open Loop Fdbk]</li> <li>Parameter 21581 - [Port 5: Analog Out 0 Data]</li> <li>Parameter 260 - [Analog In0 Value]</li> </ul>

See [DPI Parameter Object on page C-16](#) (Class code 0x93) or [Host DPI Parameter Object on page C-30](#) (Class code 0x9F) for parameter numbering.

**Figure 6.38 Example Scattered Read Request Data File for PowerFlex 7-Class Drive**

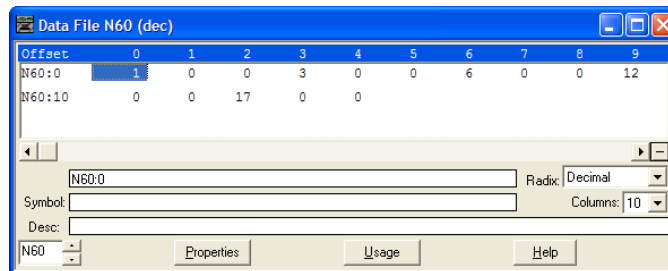

**Figure 6.39 Example Scattered Read Request Data File for PowerFlex 750-Series Drive**

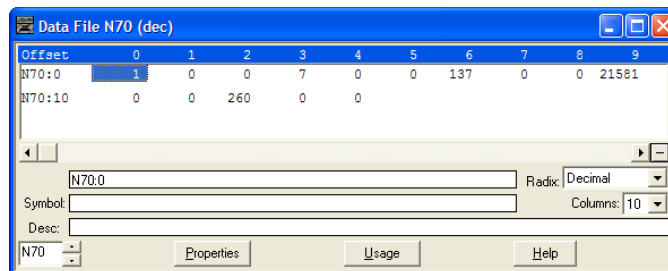

### PLC-5 Controller Example Scattered Read Response Data

In this message example, we use the data table addresses in [Figure 6.40](#) to store the response values that were read from the requested drive parameters.

**Figure 6.40 Example Scattered Read Response Data File for PowerFlex 7-Class Drive**

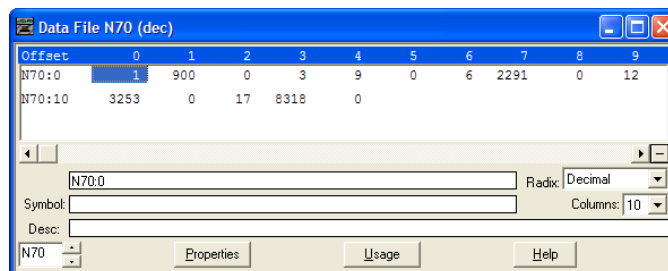



In this example, the parameters have the following values.

PowerFlex 7-Class Drive Parameter	Address	Read Value
1 - [Output Freq]	N70:1	90.0 Hz
3 - [Output Current]	N70:4	0.09 Amp
6 - [Output Voltage]	N70:7	229.1V AC
12 - [DC Bus Voltage]	N70:10	325.3V DC
17 - [Analog In2 Value]	N70:13	8.318 mA

**Figure 6.41 Example Scattered Read Response Data File for PowerFlex 750-Series Drive**

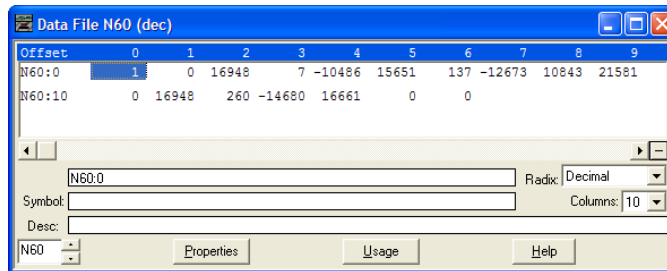

The PowerFlex 750-Series drive uses 32-bit integer and REAL parameters. A COP command must be used to copy the N60 integer array to a 16-bit integer or floating tag. [Figure 6.42](#) shows the ladder logic used for this example. If the parameter data type is a 32-bit integer, the data remains split into two 16-bit integers because there are no 32-bit integers in the PLC-5 controller. If the parameter data type is a REAL, then the destination tag is a floating point. In this case, the value must first be swapped with the high and low 16-bit integers, and then the two integers copied (COP) into a floating point address. See the drive documentation to determine the parameter data type (32-bit integer or REAL).

**Figure 6.42 Example Ladder Logic to Copy Response Data for PowerFlex 750-Series Drive**

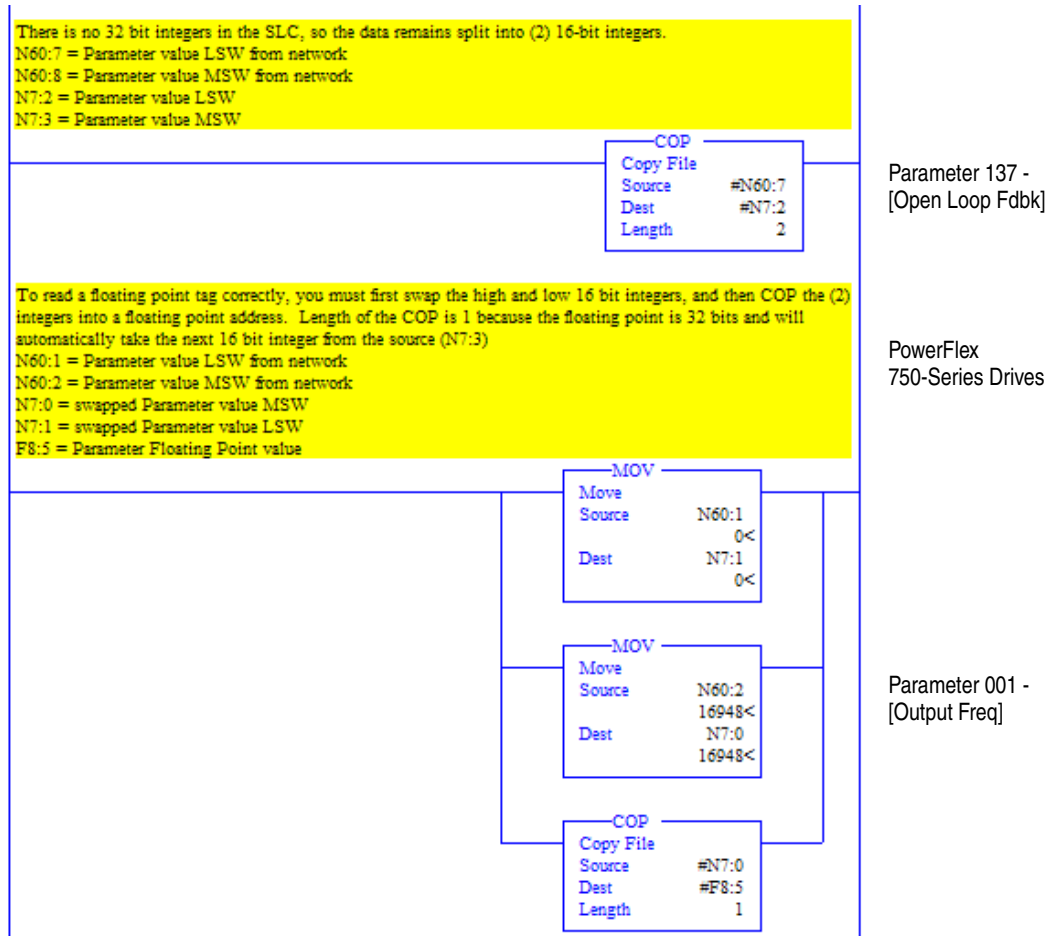

In this message example, the parameters have the following values.

PowerFlex 750-Series Drive Parameter	Read Value	Data Type
1 - [Output Freq]	45.0 Hz	REAL
7 - [Output Current]	0.04 Amp	REAL
137 - [Open Loop Fdbk]	710659711	DINT
21581 - [Port 5: Analog Out 0 Data]	45.0 Hz	REAL
260 - [Analog In0 Value]	9.361 Volts	REAL

## PLC-5 Controller Example Ladder Logic Program to Write Multiple Parameters

A Generic Bi-Directional scattered write message is used to write to multiple parameters. This write message example writes the following values to these five parameters.

PowerFlex 7-Class Drive Parameter	Write Value	PowerFlex 750-Series Drive Parameter	Write Value
141 - [Accel Time 2]	11.1 Sec.	536 - [Accel Time 2]	11.1 Sec.
143 - [Decel Time 2]	22.2 Sec.	538 - [Decel Time 2]	22.2 Sec.
105 - [Preset Speed 5]	33.3 Hz.	725 - [Zero Position]	33
106 - [Preset Speed 6]	44.4 Hz.	21555 - [Port 5: Analog In0 Hi]	5.5
107 - [Preset Speed 7]	55.5 Hz.	780 - [PTP Setpoint]	-75,555

See [DPI Parameter Object on page C-16](#) (Class code 0x93) or [Host DPI Parameter Object on page C-30](#) (Class code 0x9F) for parameter numbering.

**Important:** See [Table 6.A on page 6-2](#) for limitations of PowerFlex 7-Class and PowerFlex 750-Series drives when using DPI Parameter Object Class code 0x93 or Host DPI Parameter Object Class code 0x9F for explicit messaging.

**Figure 6.43 Example Ladder Logic to Write Multiple Parameters**

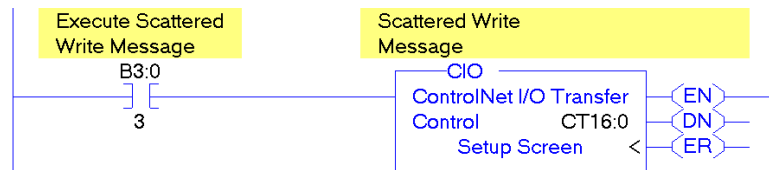

**Important:** If the explicit message scattered write must be written continuously, then use a separate Generic Set service explicit message single write for each parameter using DPI Parameter Object Class code 0x93 or Host DPI Parameter Object Class code 0x9F and attribute A (see [page 6-27](#)). Attribute A writes to RAM—not NVS (EEPROM) memory. This example scattered write message writes to NVS. Over time, continuous writes will exceed the EEPROM life cycle and cause the drive to malfunction.

## PLC-5 Controller – Formatting a Message to Write Multiple Parameters

Figure 6.44 Scattered Write Multiple Message Configuration Screens

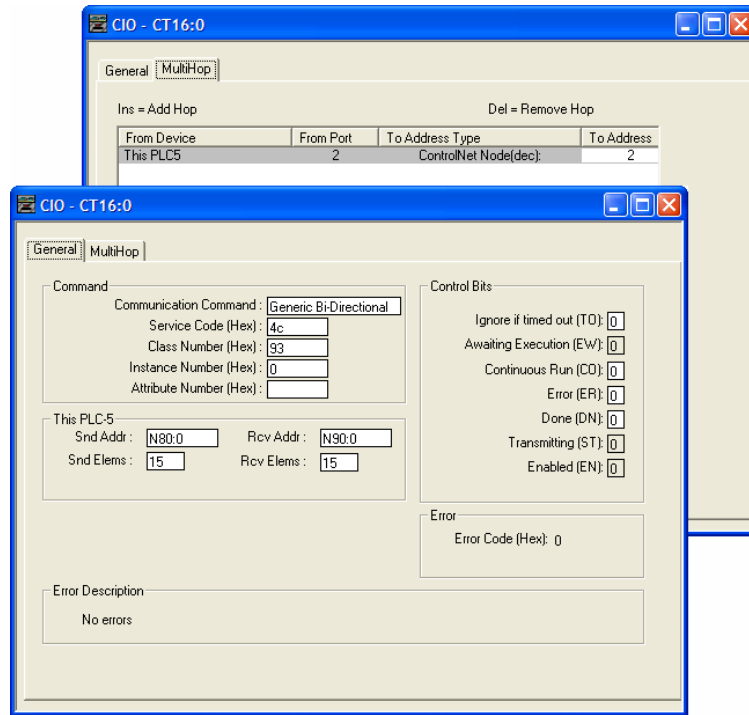

The following table identifies the data that is required in each box to configure a message to write multiple parameters.

General Tab	Example Value	Description
Communication Command	Generic Bi-Directional	Command type for the controller to write multiple data to the drive.
Service Code	4c (Hex.)	Code for the requested service.
Class Number	93 or 9F (Hex.) <sup>(1)</sup>	Class ID for the DPI Parameter Object.
Instance Number	0 (Hex.)	Required for scattered messages.
Attribute Number	—	Not used.
Snd Addr	N80:0	An unused controller data table address containing the message instruction. This address is the starting word of the source file.
Snd Elems	15 <sup>(2)</sup>	Number of elements (words) to be transferred. Each element size is a 16-bit integer.
Rcv Addr	N90:0	An unused controller data table address containing the message instruction. This address is the starting word of the destination file.
Rcv Elems	15 <sup>(2)</sup>	Number of elements (words) to be transferred. Each element size is a 16-bit integer.
MultiHop Tab	Example Value	Description
To Address	2	The node address of the adapter connected to the drive.

<sup>(1)</sup> See [Table 6.A on page 6-2](#) for limitations of PowerFlex 7-Class and PowerFlex 750-Series drives when using DPI Parameter Object Class code 0x93 or Host DPI Parameter Object Class code 0x9F for explicit messaging.

<sup>(2)</sup> In this example, we are writing to five parameters. Each parameter being written to requires three contiguous 16-bit words. Scattered write messages always assume that every parameter being written to is a 32-bit integer, regardless of its actual data type. The data structure format is the same as shown on [page 6-29](#). Maximum length is 66 words, which equates to 22 parameters. For parameter numbering, see [DPI Parameter Object on page C-16](#) (Class code 0x93) or [Host DPI Parameter Object on page C-30](#) (Class code 0x9F).

### PLC-5 Controller Example Scattered Write Request Data

In this message example, we use the data table addresses in [Figure 6.45](#) or [Figure 6.48](#) to store the request values to be written to these drive parameters.

PowerFlex 7-Class Drive Parameter	Address	Write Value	PowerFlex 750-Series Drive Parameter	Write Value	Data Type
141 - [Accel Time 2]	N90:1	11.1 Sec.	536 - [Accel Time 2]	11.1 Sec.	REAL
143 - [Decel Time 2]	N90:4	22.2 Sec.	538 - [Decel Time 2]	22.2 Sec.	REAL
105 - [Preset Speed 5]	N90:7	33.3 Hz.	725 - [Zero Position]	33	32-bit integer
106 - [Preset Speed 6]	N90:10	44.4 Hz.	21555 - [Port 5: Analog In0 Hi]	5.5	REAL
107 - [Preset Speed 7]	N90:13	55.5 Hz.	780 - [PTP Setpoint]	-75,555	32-bit integer

See [DPI Parameter Object on page C-16](#) (Class code 0x93) or [Host DPI Parameter Object on page C-30](#) (Class code 0x9F) for parameter numbering.

[Figure 6.45](#) or [Figure 6.48](#) shows the parameter values.

**Figure 6.45 Example Scattered Write Request Data File for PowerFlex 7-Class Drive**

Offset	0	1	2	3	4	5	6	7	8	9
N80:0	141	111	0	143	222	0	105	333	0	106
N80:10	444	0	107	555	0					

### PLC-5 Controller Example Scattered Write Response Data

In this message example, we use the data table addresses in [Figure 6.46](#) to store the response values that were written to the requested drive parameters. Values of '0' indicate no errors occurred.

**Figure 6.46 Example Scattered Write Response Data File for PowerFlex 7-Class Drive**

Offset	0	1	2	3	4	5	6	7	8	9
N90:0	141	0	0	143	0	0	105	0	0	106
N90:10	0	0	107	0	0					

The PowerFlex 750-Series drive uses 32-bit integer and REAL parameters. A COP command must be used to copy the 16-bit integer or REAL values to the N90 integer array. [Figure 6.47](#) shows the ladder logic used for this example. If the parameter data type is a 32-bit integer, the data remains split into two 16-bit integers since there are no 32-bit integers in the PLC-5

controller. If the parameter data type is a REAL, the floating point value in the PLC-5 controller is copied (COP) to two 16-bit integers. Then the MSW (most significant word) and LSW (least significant word) must be swapped before moving (MOV) the values to the array to be written to. See the drive documentation to determine the parameter data type (32-bit integer or REAL).

**Figure 6.47 Example Ladder Logic to Copy Request Data for PowerFlex 750-Series Drive**

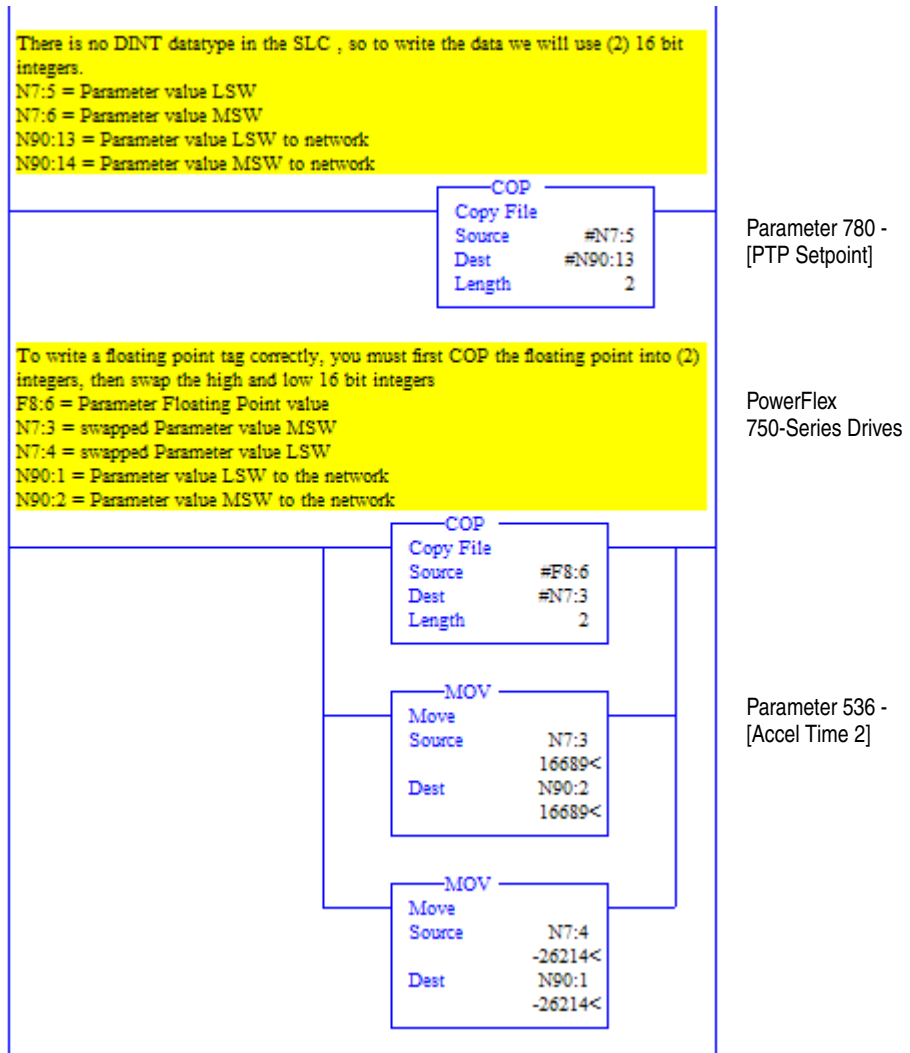

Figure 6.48 Example Scattered Write Request Data File for PowerFlex 750-Series Drive

Offset	0	1	2	3	4	5	6	7	8	9
N90:0	536	-26214	16689	538	-26214	16817	725	33	0	21555
N90:10	0	16560	780	-10019	-2					

Symbol:  Radix:   
 Columns:   
 Desc:

The results of the explicit message appear in the destination tag array N80 (Figure 6.49). Values of '0' indicate no errors occurred.

Figure 6.49 Example Scattered Write Response Data File for PowerFlex 750-Series Drive

Offset	0	1	2	3	4	5	6	7	8	9
N80:0	536	0	0	538	0	0	725	0	0	21555
N80:10	0	0	780	0	0					

Symbol:  Radix:   
 Columns:   
 Desc:

## SLC 500 Controller Examples

The CIP messaging method provides two ways to perform explicit messaging:

- Read/Write Parameter Service simplifies setup by requiring less data to be entered in message configuration screens. However, the Read/Write Parameter Service can only be used to perform single parameter read or single parameter write explicit messages. (Multiple parameter reads or writes must be performed using the Generic Get/Set Attribute Service described below.)

**Important:** When performing a Write Parameter message, the data will always be written to the drive's Nonvolatile Storage (NVS). Continuous NVS writes may damage the drive's EEPROM. If continuous writes are necessary, use the Generic Set Attribute Single Service and attribute 10 (see [page 6-51](#)).

- Generic Get/Set Attribute Service requires more setup data to be entered in message configuration screens, but can be used to perform single parameter read or write explicit messages or multiple parameter read or write explicit messages. Also, the Generic Set Attribute Service offers the choice of writing the data to the drive's Nonvolatile Storage (NVS) or the drive's Random Access Memory (RAM; for Generic Set Attribute Single service only, see [page 6-51](#)). Note that when selecting the data to be written to RAM, the data will be lost if the drive loses power.

For supported classes, instances, and attributes, see [Appendix C, ControlNet Objects](#).

Block transfer or CEM (ControlNet Explicit Message) instructions can be used to perform explicit messaging. Since CEM instructions are easier to configure and perform more efficiently, they are used for these examples.

**Important:** RSLogix 500 software, version 7.10 or later, and a SLC 5/03, SLC 5/04, or SLC 5/05 controller, Series C with firmware version 10.00 or later, are required to use CEM instructions.



## SLC 500 Controller Explicit Messaging Using the Read/Write Parameter Service

SLC 500 Controller Example Ladder Logic Program to Read a Single Parameter

A Read Parameter message is used to read a single parameter. This read message example reads the value of parameter 003 - [Output Current] in a PowerFlex 7-Class drive.

**Important:** Parameter Object Class code 0x0F is not supported in PowerFlex 750-Series drives. To do a single parameter read, follow the SLC 500 (Generic Attribute Service) single read example on [page 6-48](#).

**Figure 6.50 Example Ladder Logic to Read a Single Parameter**

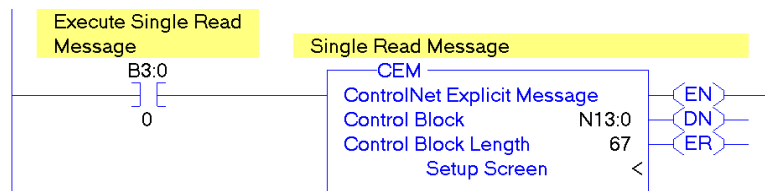

### SLC 500 Controller – Formatting a Message to Read a Single Parameter Using Read/Write Parameter Service

**Figure 6.51 Read Parameter Message Configuration Screen**

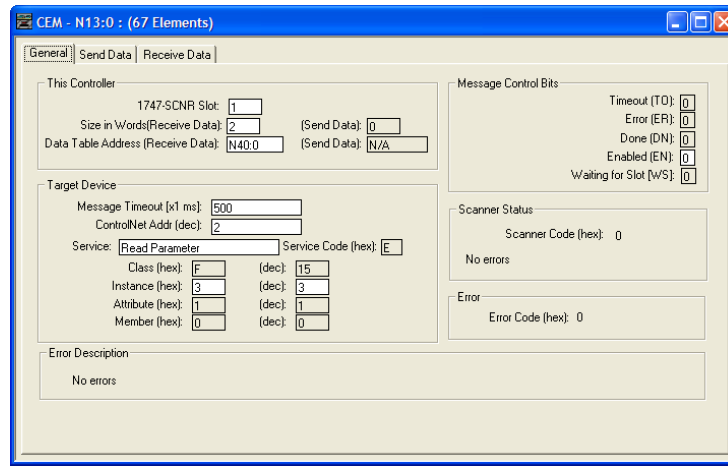

The following table identifies the data that is required in each box to configure a message to read a single parameter.

General Tab	Example Value	Description
1747-SCNR Slot	1	The chassis slot occupied by the scanner.
Size in Words (Receive Data)	2 <sup>(3)</sup>	Number of words to be received (read). Each word size is a 16-bit integer.
Data Table Address (Receive Data)	N40:0	An unused controller data table address containing the message instruction. This address is the starting word of the destination file.
Message Timeout	500	The time (in milliseconds) that the message must be completed.
ControlNet Addr	2	The node address of the adapter connected to the drive.
Service <sup>(1)</sup>	Read Parameter	Code for the requested service.
Instance <sup>(2)</sup>	3 (Dec.)	Instance number is the same as the parameter number.

<sup>(1)</sup> The default setting for Service is 'Custom', enabling entry of a Service Code not available from the Service pull-down menu. When choosing a Service other than 'Custom' from the pull-down menu, an appropriate Hex. value is automatically assigned to the Service Code box which is dimmed (unavailable).

<sup>(2)</sup> Only drive parameters (Port 0) can be read using Parameter Object Class code 0x0F. To read a parameter of a peripheral in another port, use DPI Parameter Object Class code 0x93 (see [page 6-47](#)).

<sup>(3)</sup> In this example, Output Current is a 32-bit integer parameter requiring the Size in Words field to be set to '2'. If the parameter being read is a 16-bit integer, the Size in Words must be set to '1'. When using a PowerFlex 700S or PowerFlex 750-Series drive, Output Current is a floating point number requiring the Size in Words to be set to '2'. See the drive documentation to determine the size of the parameter and its data type (16-bit or 32-bit integer or REAL).

### SLC 500 Controller Example Read Single Response Data

In this message example, we use the data table address in [Figure 6.52](#) to store the response value (0.13 amps) that was read from drive parameter 003 - [Output Current]. To determine the data type for the parameter and its required scaling, see the specific drive documentation.

**Figure 6.52 Example Read Single Response Data File**

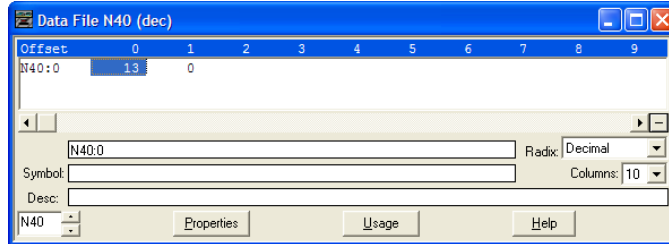

[Figure 6.53](#) shows example ladder logic to correctly format the three possible data types for read messages of different parameter types in the SLC 500 controller.

**Figure 6.53 Example Ladder Logic to Format Parameter Data Types for Reads**

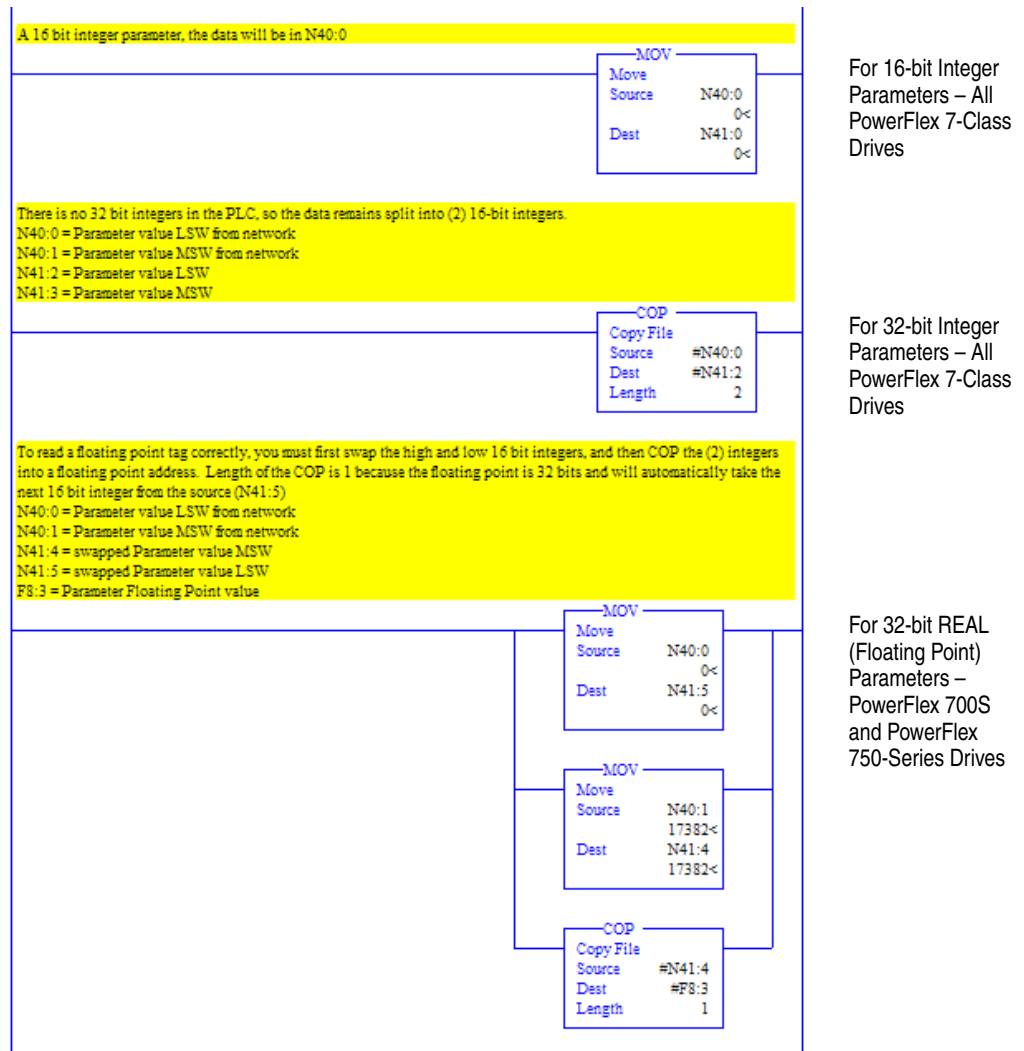

### SLC 500 Controller Example Ladder Logic Program to Write a Single Parameter Using Read/Write Parameter Service

A Write Parameter message is used to write to a single parameter. This write message example writes a value to parameter 140 - [Accel Time 1] in a PowerFlex 7-Class drive.

**Important:** Parameter Object Class code 0x0F is not supported in PowerFlex 750-Series drives. To do a single parameter write, follow the SLC 500 (Generic Attribute Service) single write example on [page 6-51](#).

**Figure 6.54 Example Ladder Logic to Write a Single Parameter**

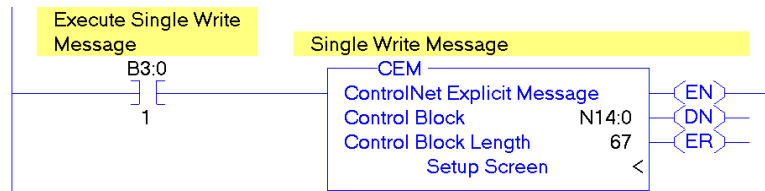

**Important:** If the explicit message single write must be written continuously, use the Generic Set Attribute Single service and attribute A (10 decimal; see [page 6-51](#)). This writes to RAM—not NVS (EEPROM) memory. This example single write message using Class code F writes to NVS. Over time, continuous writes will exceed the EEPROM life cycle and cause the drive to malfunction.

## SLC 500 Controller – Formatting a Message to Write a Single Parameter Using Read/Write Parameter Service

**Figure 6.55 Write Parameter Message Configuration Screen**

The following table identifies the data that is required in each box to configure a message to write a single parameter.

General Tab	Example Value	Description
1747-SCNR Slot	1	The chassis slot occupied by the scanner.
Size in Words (Send Data)	1 <sup>(3)</sup>	Number of words to be sent (written). Each word size is a 16-bit integer.
Data Table Address (Send Data)	N50:0	An unused controller data table address containing the message instruction. This address is the starting word of the source file.
Message Timeout	500	The time (in milliseconds) that the message must be completed.
ControlNet Addr	2	The node address of the adapter connected to the drive.
Service <sup>(1)</sup>	Write Parameter	Code for the requested service.
Instance <sup>(2)</sup>	140 (Dec.)	Instance number is the same as the parameter number.

<sup>(1)</sup> The default setting for Service is 'Custom', enabling entry of a Service Code not available from the Service pull-down menu. When choosing a Service other than 'Custom' from the pull-down menu, an appropriate Hex. value is automatically assigned to the Service Code box which is dimmed (unavailable).

<sup>(2)</sup> Only drive parameters (Port 0) can be written to using Parameter Object Class code 0x0F. To write to a parameter of a peripheral in another port, use DPI Parameter Object Class code 0x93 (see [page 6-54](#)).

<sup>(3)</sup> In this example, Accel Time 1 is a 16-bit integer parameter requiring the Size in Words field to be set to '1'. If the parameter being written to is a 32-bit integer, the Size in Words must be set to '2'. When using a PowerFlex 700S or PowerFlex 750-Series drive, Accel Time 1 is a floating point number requiring the Size in Words to be set to '2'. See the drive documentation to determine the size of the parameter and its data type (16-bit or 32-bit integer or REAL).

### SLC 500 Controller Example Write Single Request Data

In this message example, we use the data table address in [Figure 6.56](#) to store the request value (10.0 sec.) that was written to drive parameter 140 - [Accel Time 1]. To determine the data type for the parameter and its required scaling, see the specific drive documentation.

**Figure 6.56 Example Write Single Request Data File**

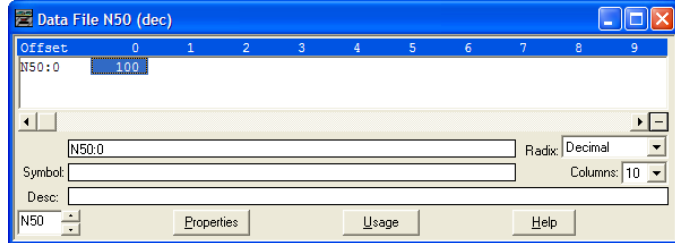

[Figure 6.57](#) shows example ladder logic to correctly format the three possible data types for write messages of different parameter types in the SLC 500 controller.

**Figure 6.57 Example Ladder Logic to Format Parameter Data Types for Writes**

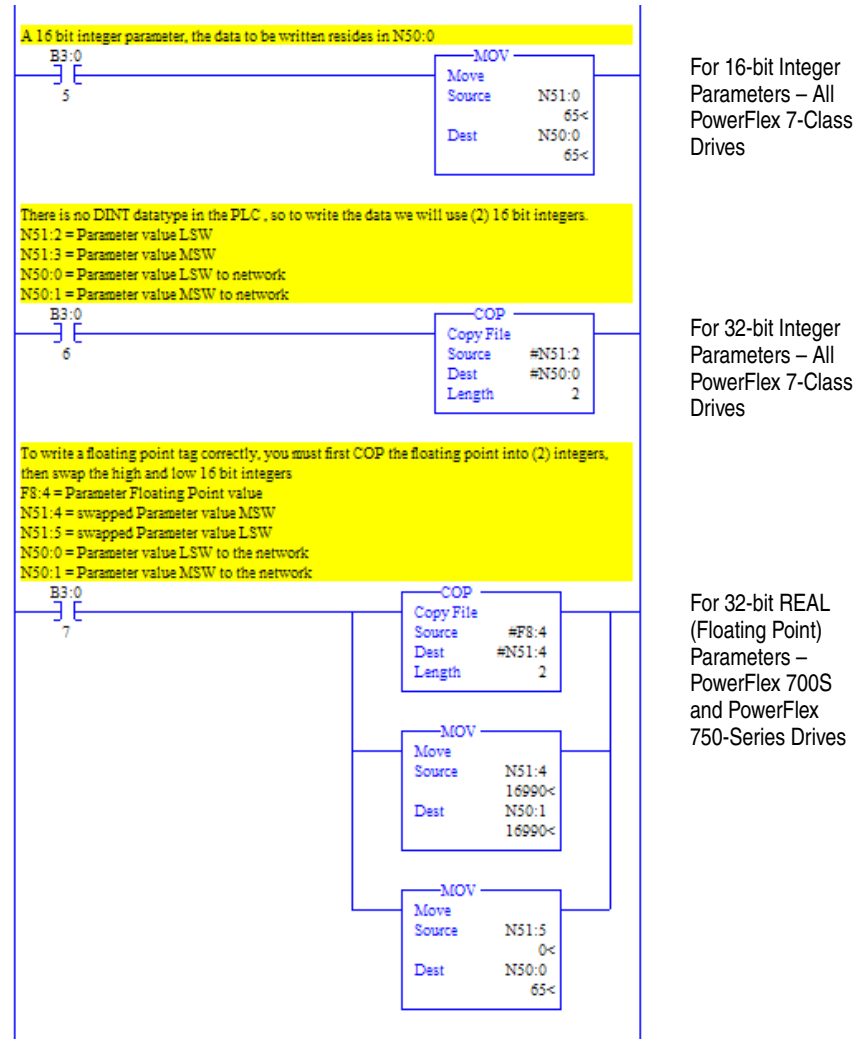

## SLC 500 Controller Explicit Messaging Using the Generic Get/Set Attribute Service

SLC 500 Controller Example Ladder Logic Program to Read a Single Parameter

A Generic Get Attribute Single message is used to read a single parameter. This read message example reads the value of parameter 003 - [Output Current] in a PowerFlex 7-Class drive.

**Important:** See [Table 6.A on page 6-2](#) for limitations of PowerFlex 7-Class and PowerFlex 750-Series drives when using DPI Parameter Object Class code 0x93 or Host DPI Parameter Object Class code 0x9F for explicit messaging.

**Figure 6.58 Example Ladder Logic to Read a Single Parameter**

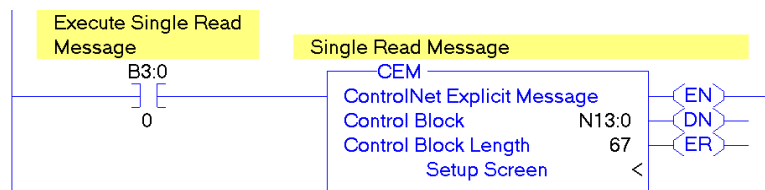

### SLC 500 Controller – Formatting a Message to Read a Single Parameter Using Generic Get/Set Attribute Service

**Figure 6.59 Generic Get Attribute Single Message Configuration Screen**

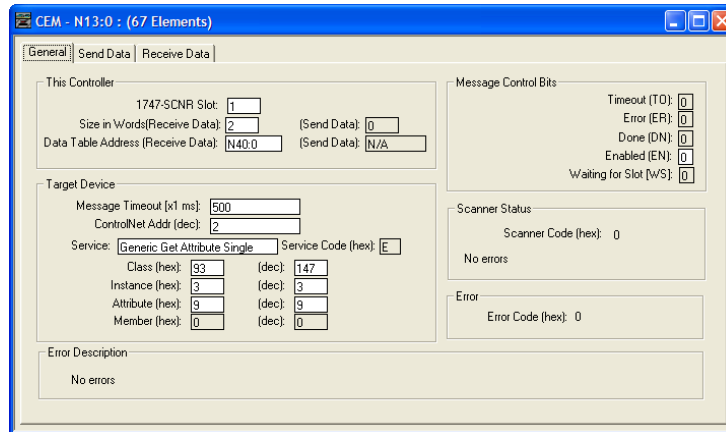

The following table identifies the data that is required in each box to configure a message to read a single parameter.

General Tab	Example Value	Description
1747-SCNR Slot	1	The chassis slot occupied by the scanner.
Size in Words (Receive Data)	2 <sup>(3)</sup>	Number of words to be received (read). Each word size is a 16-bit integer.
Data Table Address (Receive Data)	N40:0	An unused controller data table address containing the message instruction. This address is the starting word of the destination file.
Message Timeout	500	The time (in milliseconds) that the message must be completed.
ControlNet Addr	2	The node address of the adapter connected to the drive.
Service <sup>(1)</sup>	Generic Get Attribute Single	Code for the requested service.
Class	93 or 9F (Hex.) <sup>(4)</sup>	Class ID for the DPI Parameter Object.
Instance <sup>(2)</sup>	3 (Dec.)	Instance number is the same as the parameter number.
Attribute	9 (Dec.)	Attribute number for the Parameter Value attribute.

- <sup>(1)</sup> The default setting for Service is 'Custom', enabling entry of a Service Code not available from the Service pull-down menu. When choosing a Service other than 'Custom' from the pull-down menu, an appropriate Hex. value is automatically assigned to the Service Code box which is dimmed (unavailable).
- <sup>(2)</sup> The instance is the parameter number in the drive (Port 0). To read a parameter in another port, see [DPI Parameter Object on page C-16](#) (Class code 0x93) or [Host DPI Parameter Object on page C-30](#) (Class code 0x9F) to determine the instance number. For example, to read parameter 4 of a peripheral in Port 5 of a PowerFlex 750-Series drive, the instance would be 21504 + 4 = 21508 or 5404 (Hex).
- <sup>(3)</sup> In this example, Output Current is a 32-bit integer parameter requiring the Size in Words field to be set to '2'. If the parameter being read is a 16-bit integer, the Size in Words must be set to '1'. When using a PowerFlex 700S or PowerFlex 750-Series drive, Output Current is a floating point number requiring the Size in Words to be set to '2'. See the drive documentation to determine the size of the parameter and its data type (16-bit or 32-bit integer or REAL). The following page shows ladder logic to convert the data into a floating point.
- <sup>(4)</sup> See [Table 6.A on page 6-2](#) for limitations of PowerFlex 7-Class and PowerFlex 750-Series drives when using DPI Parameter Object Class code 0x93 or Host DPI Parameter Object Class code 0x9F for explicit messaging.



### SLC 500 Controller Example Get Attribute Single Response Data

In this message example, we use the data table address in [Figure 6.60](#) to store the response value (0.13 amps) that was read from drive parameter 003 - [Output Current]. To determine the data type for the parameter and its required scaling, see the specific drive documentation.

**Figure 6.60 Example Get Attribute Single Response Data File**

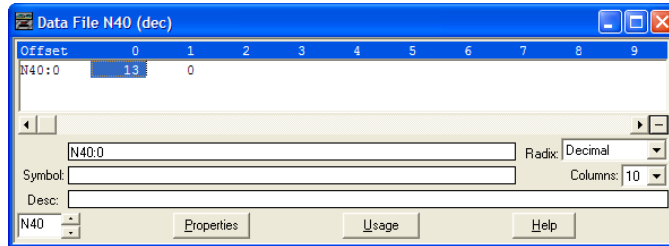

[Figure 6.61](#) shows example ladder logic to correctly format the three possible data types for get messages of different parameter types in the SLC 500 controller.

**Figure 6.61 Example Ladder Logic to Format Parameter Data Types for Gets**

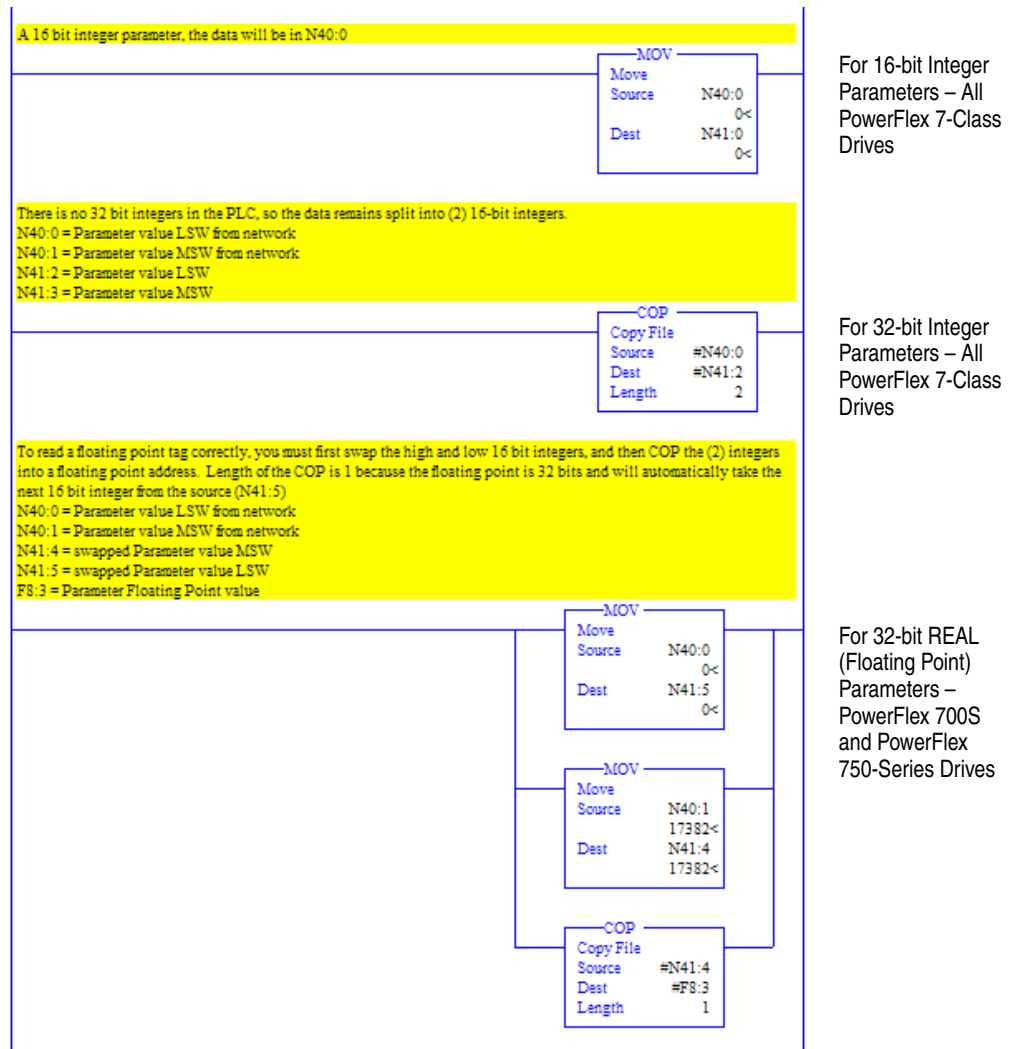

SLC 500 Controller Example Ladder Logic Program to Write a Single Parameter Using Generic Get/Set Attribute Service

A Generic Set Attribute Single message is used to write to a single parameter. This write message example writes a value to parameter 140 - [Accel Time 1] in a PowerFlex 7-Class drive.

**Important:** See [Table 6.A on page 6-2](#) for limitations of PowerFlex 7-Class and PowerFlex 750-Series drives when using DPI Parameter Object Class code 0x93 or Host DPI Parameter Object Class code 0x9F for explicit messaging.

Figure 6.62 Example Ladder Logic to Write a Single Parameter

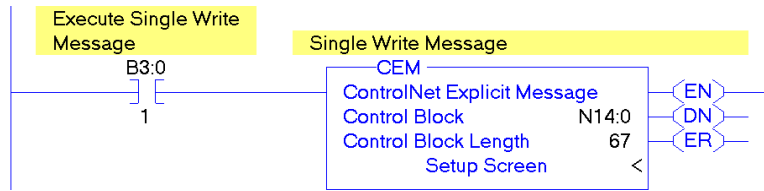

## SLC 500 Controller – Formatting a Message to Write a Single Parameter Using Generic Get/Set Attribute Service

**Figure 6.63 Generic Set Attribute Single Message Configuration Screen**

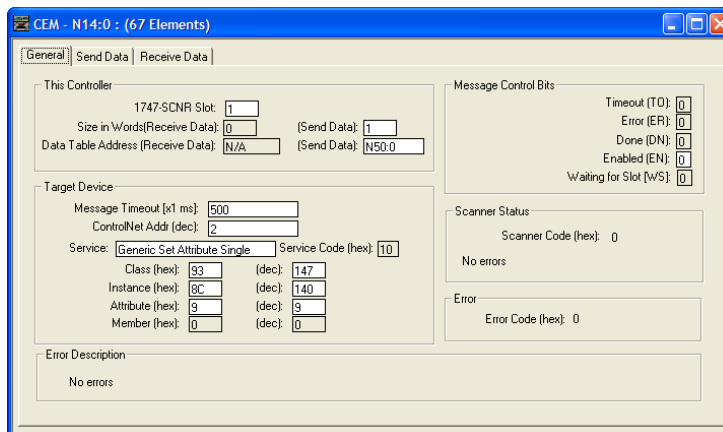

The following table identifies the data that is required in each box to configure a message to write a single parameter.

General Tab	Example Value	Description
1747-SCNR Slot	1	The chassis slot occupied by the scanner.
Size in Words (Send Data)	1 (4)	Number of words to be sent (written). Each word size is a 16-bit integer.
Data Table Address (Send Data)	N50:0	An unused controller data table address containing the message instruction. This address is the starting word of the source file.
Message Timeout	500	The time (in milliseconds) that the message must be completed.
ControlNet Addr	2	The node address of the adapter connected to the drive.
Service <sup>(1)</sup>	Generic Set Attribute Single	Code for the requested service.
Class	93 or 9F (Hex.) <sup>(5)</sup>	Class ID for the DPI Parameter Object.
Instance <sup>(2)</sup>	140 (Dec.)	Instance number is the same as the parameter number.
Attribute <sup>(3)</sup>	9 or 10 (Dec.)	Attribute number for the Parameter Value attribute.

<sup>(1)</sup> The default setting for Service is 'Custom', enabling entry of a Service Code not available from the Service pull-down menu. When choosing a Service other than 'Custom' from the pull-down menu, an appropriate Hex. value is automatically assigned to the Service Code box which is dimmed (unavailable).

<sup>(2)</sup> The instance is the parameter number in the drive (Port 0). To write to a parameter in another port, see [DPI Parameter Object on page C-16](#) (Class code 0x93) or [Host DPI Parameter Object on page C-30](#) (Class code 0x9F) to determine the instance number. For example, to write to parameter 51 of a peripheral in Port 5 of a PowerFlex 750-Series drive, the instance would be  $21504 + 51 = 21555$  or 5433 (Hex).

<sup>(3)</sup> Setting the Attribute value to '9' will write the parameter value to the drive's Nonvolatile Storage (EEPROM) memory, which retains the parameter value even after the drive is power cycled. **Important:** When set to '9', the EEPROM may quickly exceed its life cycle and cause the drive to malfunction. Setting the Attribute value to 'A' (10 decimal) will write the parameter value to temporary memory, which deletes the parameter value after the drive is power cycled. When frequent write messages are required, we recommend using the 'A' (10 decimal) setting.

<sup>(4)</sup> In this example, Accel Time 1 is a 16-bit integer parameter requiring the Size in Words field to be set to '1'. If the parameter being written to is a 32-bit integer, the Size in Words must be set to '2'. When using a PowerFlex 700S or PowerFlex 750-Series drive, Accel Time 1 is a floating point number requiring the Size in Words to be set to '2'. See the drive documentation to determine the size of the parameter and its data type (16-bit or 32-bit integer or REAL). The following page shows ladder logic to convert floating point data into integer files.

<sup>(5)</sup> See [Table 6.A on page 6-2](#) for limitations of PowerFlex 7-Class and PowerFlex 750-Series drives when using DPI Parameter Object Class code 0x93 or Host DPI Parameter Object Class code 0x9F for explicit messaging.

### SLC 500 Controller Example Set Attribute Single Request Data

In this message example, we use the data table address in [Figure 6.64](#) to store the request value (10.0 sec.) that was written to drive parameter 140 - [Accel Time 1]. To determine the data type for the parameter and its required scaling, see the specific drive documentation.

**Figure 6.64 Example Set Attribute Single Request Data File**

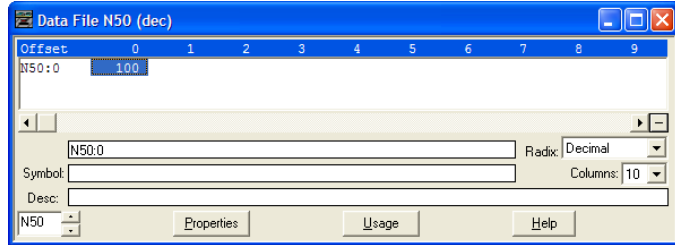

[Figure 6.65](#) shows example ladder logic to correctly format the three possible data types for set messages of different parameter types in the SLC 500 controller.

**Figure 6.65 Example Ladder Logic to Format Parameter Data Types for Sets**

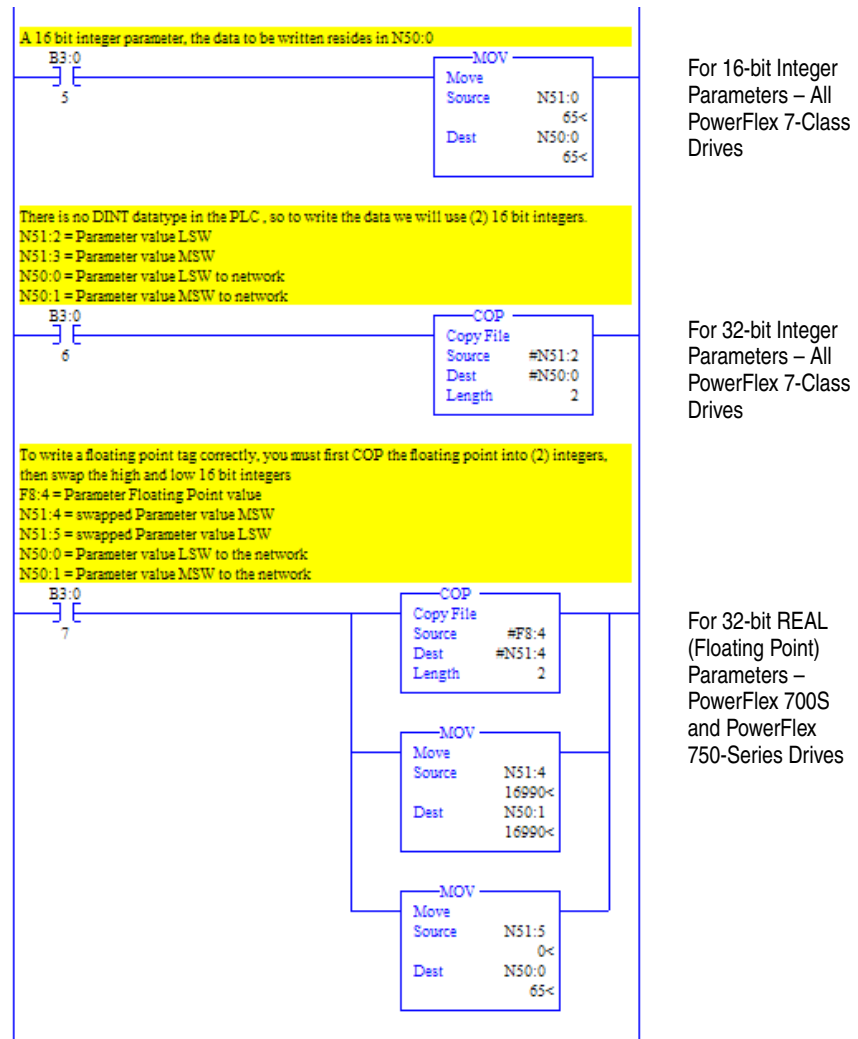

## SLC 500 Controller – Explanation of Request and Response Data for Read/Write Multiple Messaging

The data structures in [Figure 6.66](#) and [Figure 6.67](#) use 16-bit words and can accommodate up to 22 parameters in a single message. In the Response Message, a parameter number with the high bit set indicates that the associated parameter value field contains an error code (parameter number in response data will be negative).

**Important:** See [Table 6.A on page 6-2](#) for limitations of PowerFlex 7-Class and PowerFlex 750-Series drives when using Class code 0x93 or Class code 0x9F for explicit messaging.

**Figure 6.66 Data Structures for Scattered Read Messages**

Request (Source Data)		Response (Destination Data)	
Word 0	Parameter Number	Word 0	Parameter Number
1	Pad Word	1	Parameter Value LSW
2	Pad Word	2	Parameter Value MSW
3	Parameter Number	3	Parameter Number
4	Pad Word	4	Parameter Value LSW
5	Pad Word	5	Parameter Value MSW
6	Parameter Number	6	Parameter Number
7	Pad Word	7	Parameter Value LSW
8	Pad Word	8	Parameter Value MSW
9	Parameter Number	9	Parameter Number
10	Pad Word	10	Parameter Value LSW
11	Pad Word	11	Parameter Value MSW
12	Parameter Number	12	Parameter Number
13	Pad Word	13	Parameter Value LSW
14	Pad Word	14	Parameter Value MSW
:		:	
63	Parameter Number	63	Parameter Number
64	Pad Word	64	Parameter Value LSW
65	Pad Word	65	Parameter Value MSW

**Figure 6.67 Data Structures for Scattered Write Messages**

Request (Source Data)		Response (Destination Data)	
Word 0	Parameter Number	Word 0	Parameter Number
1	Parameter Value LSW	1	Pad Word
2	Parameter Value MSW	2	Pad Word
3	Parameter Number	3	Parameter Number
4	Parameter Value LSW	4	Pad Word
5	Parameter Value MSW	5	Pad Word
6	Parameter Number	6	Parameter Number
7	Parameter Value LSW	7	Pad Word
8	Parameter Value MSW	8	Pad Word
9	Parameter Number	9	Parameter Number
10	Parameter Value LSW	10	Pad Word
11	Parameter Value MSW	11	Pad Word
12	Parameter Number	12	Parameter Number
13	Parameter Value LSW	13	Pad Word
14	Parameter Value MSW	14	Pad Word
:		:	
63	Parameter Number	63	Parameter Number
64	Parameter Value LSW	64	Pad Word
65	Parameter Value MSW	65	Pad Word

### SLC 500 Controller Explicit Messaging Using the Generic Get/Set Attribute Service

#### SLC 500 Controller Example Ladder Logic Program to Read Multiple Parameters

A Custom scattered read message is used to read the values of multiple parameters. This read message example reads the values of these five parameters.

PowerFlex 7-Class Drive	PowerFlex 750-Series Drive
<ul style="list-style-type: none"> <li>• Parameter 001 - [Output Freq]</li> <li>• Parameter 003 - [Output Current]</li> <li>• Parameter 006 - [Output Voltage]</li> <li>• Parameter 012 - [DC Bus Voltage]</li> <li>• Parameter 017 - [Analog In1 Value]</li> </ul>	<ul style="list-style-type: none"> <li>• Parameter 001 - [Output Freq]</li> <li>• Parameter 007 - [Output Current]</li> <li>• Parameter 137 - [Open Loop Fdbk]</li> <li>• Parameter 21581 - [Port 5: Analog Out 0 Data]</li> <li>• Parameter 260 - [Analog In0 Value]</li> </ul>

See [DPI Parameter Object on page C-16](#) (Class code 0x93) or [Host DPI Parameter Object on page C-30](#) (Class code 0x9F) for parameter numbering.

**Important:** See [Table 6.A on page 6-2](#) for limitations of PowerFlex 7-Class and PowerFlex 750-Series drives when using DPI Parameter Object Class code 0x93 or Host DPI Parameter Object Class code 0x9F for explicit messaging.

Figure 6.68 Example Ladder Logic to Read Multiple Parameters

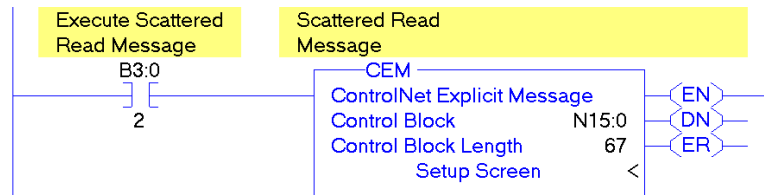

## SLC 500 Controller – Formatting a Message to Read Multiple Parameters Using Generic Get/Set Attribute Service

**Figure 6.69 Custom Scattered Read Message Configuration Screen**

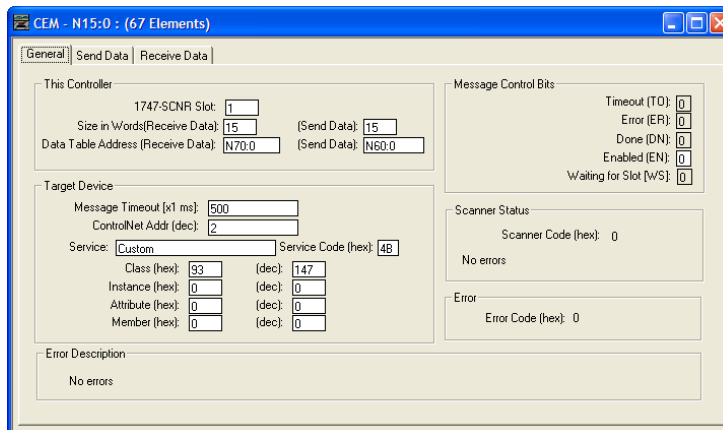

The following table identifies the data that is required in each box to configure a message to read multiple parameters.

General Tab	Example Value	Description
1747-SCNR Slot	1	The chassis slot occupied by the scanner.
Size in Words (Receive Data)	15 <sup>(2)</sup>	Number of words to be received (read). Each word size is a 16-bit integer.
Size in Words (Send Data)	15 <sup>(2)</sup>	Number of words to be sent. Each word size is a 16-bit integer.
Data Table Address (Receive Data)	N70:0	An unused controller data table address containing the message instruction. This address is the starting word of the destination file.
Data Table Address (Send Data)	N60:0	An unused controller data table address containing the message instruction. This address is the starting word of the source file.
Message Timeout	500	The time (in milliseconds) that the message must be completed.
ControlNet Addr	2	The node address of the adapter connected to the drive.
Service <sup>(1)</sup>	Custom	Required for scattered messages.
Service Code	4B (Hex.)	Code for the requested service.
Class	93 or 9F (Hex.) <sup>(3)</sup>	Class ID for the DPI Parameter Object.
Instance	0 (Dec.)	Required for scattered messages.
Attribute	0 (Dec.)	Required for scattered messages.

<sup>(1)</sup> The default setting for Service is 'Custom', enabling entry of a Service Code not available from the Service pull-down menu. When choosing a Service other than 'Custom' from the pull-down menu, an appropriate Hex. value is automatically assigned to the Service Code box which is dimmed (unavailable).

<sup>(2)</sup> In this example, we are reading five parameters. Each parameter being read requires three contiguous 16-bit words. Scattered read messages always assume that every parameter being read is a 32-bit integer, regardless of its actual data type. The data structure format is the same as shown on [page 6-53](#). Maximum length is 66 words, which equates to 22 parameters. For parameter numbering, see [DPI Parameter Object on page C-16](#) (Class code 0x93) or [Host DPI Parameter Object on page C-30](#) (Class code 0x9F).

<sup>(3)</sup> See [Table 6.A on page 6-2](#) for limitations of PowerFlex 7-Class and PowerFlex 750-Series drives when using DPI Parameter Object Class code 0x93 or Host DPI Parameter Object Class code 0x9F for explicit messaging.

### SLC 500 Controller Example Scattered Read Request Data

In this message example, we use the data table addresses in [Figure 6.70](#) or [Figure 6.71](#) to store the request values to be read from these drive parameters.

PowerFlex 7-Class Drive	PowerFlex 750-Series Drive
<ul style="list-style-type: none"> <li>• Parameter 001 - [Output Freq]</li> <li>• Parameter 003 - [Output Current]</li> <li>• Parameter 006 - [Output Voltage]</li> <li>• Parameter 012 - [DC Bus Voltage]</li> <li>• Parameter 017 - [Analog In1 Value]</li> </ul>	<ul style="list-style-type: none"> <li>• Parameter 001 - [Output Freq]</li> <li>• Parameter 007 - [Output Current]</li> <li>• Parameter 137 - [Open Loop Fdbk]</li> <li>• Parameter 21581 - [Port 5: Analog Out 0 Data]</li> <li>• Parameter 260 - [Analog In0 Value]</li> </ul>

See [DPI Parameter Object on page C-16](#) (Class code 0x93) or [Host DPI Parameter Object on page C-30](#) (Class code 0x9F) for parameter numbering.

**Figure 6.70 Example Scattered Read Request Data File for PowerFlex 7-Class Drive**

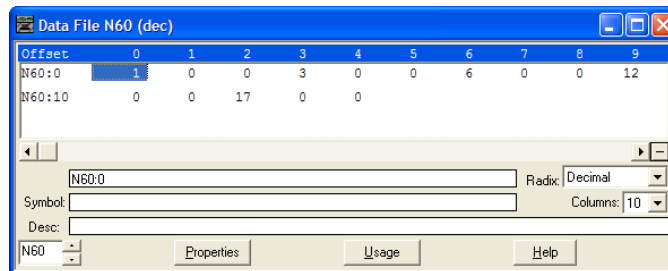

**Figure 6.71 Example Scattered Read Request Data File for PowerFlex 750-Series Drive**

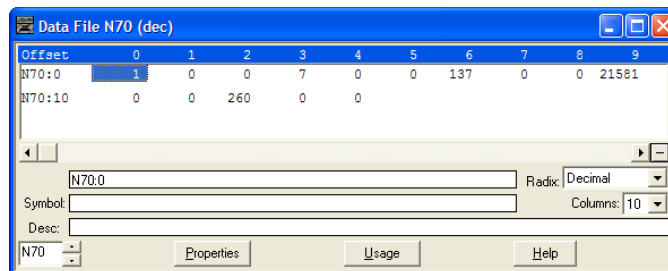

### SLC 500 Controller Example Scattered Read Response Data

In this message example, we use the data table addresses in [Figure 6.72](#) to store the response values that were read from the requested drive parameters.

**Figure 6.72 Example Scattered Read Response Data File for PowerFlex 7-Class Drive**

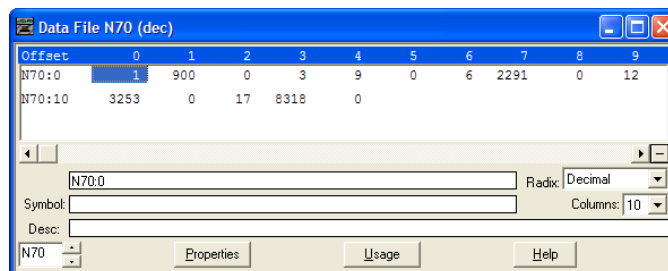



In this example, the parameters have the following values.

PowerFlex 7-Class Drive Parameter	Address	Read Value
1 - [Output Freq]	N70:1	90.0 Hz
3 - [Output Current]	N70:4	0.09 Amp
6 - [Output Voltage]	N70:7	229.1V AC
12 - [DC Bus Voltage]	N70:10	325.3V DC
17 - [Analog In2 Value]	N70:13	8.318 mA

**Figure 6.73 Example Scattered Read Response Data File for PowerFlex 750-Series Drive**

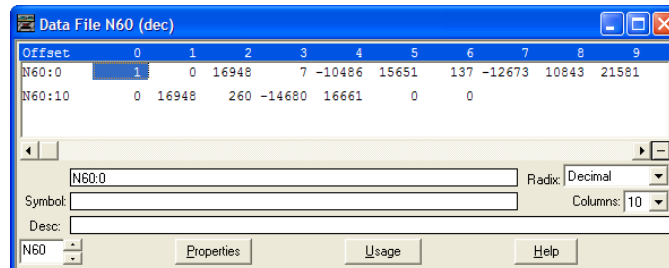

The PowerFlex 750-Series drive uses 32-bit integer and REAL parameters. A COP command must be used to copy the N60 integer array to a 16-bit integer or floating tag. [Figure 6.74](#) shows the ladder logic used for this example. If the parameter data type is a 32-bit integer, the data remains split into two 16-bit integers because there are no 32-bit integers in the SLC 500 controller. If the parameter data type is a REAL, then the destination tag is a floating point. In this case, the value must first be swapped with the high and low 16-bit integers, and then the two integers copied (COP) into a floating point address. See the drive documentation to determine the parameter data type (32-bit integer or REAL).

**Figure 6.74 Example Ladder Logic to Copy Response Data for PowerFlex 750-Series Drive**

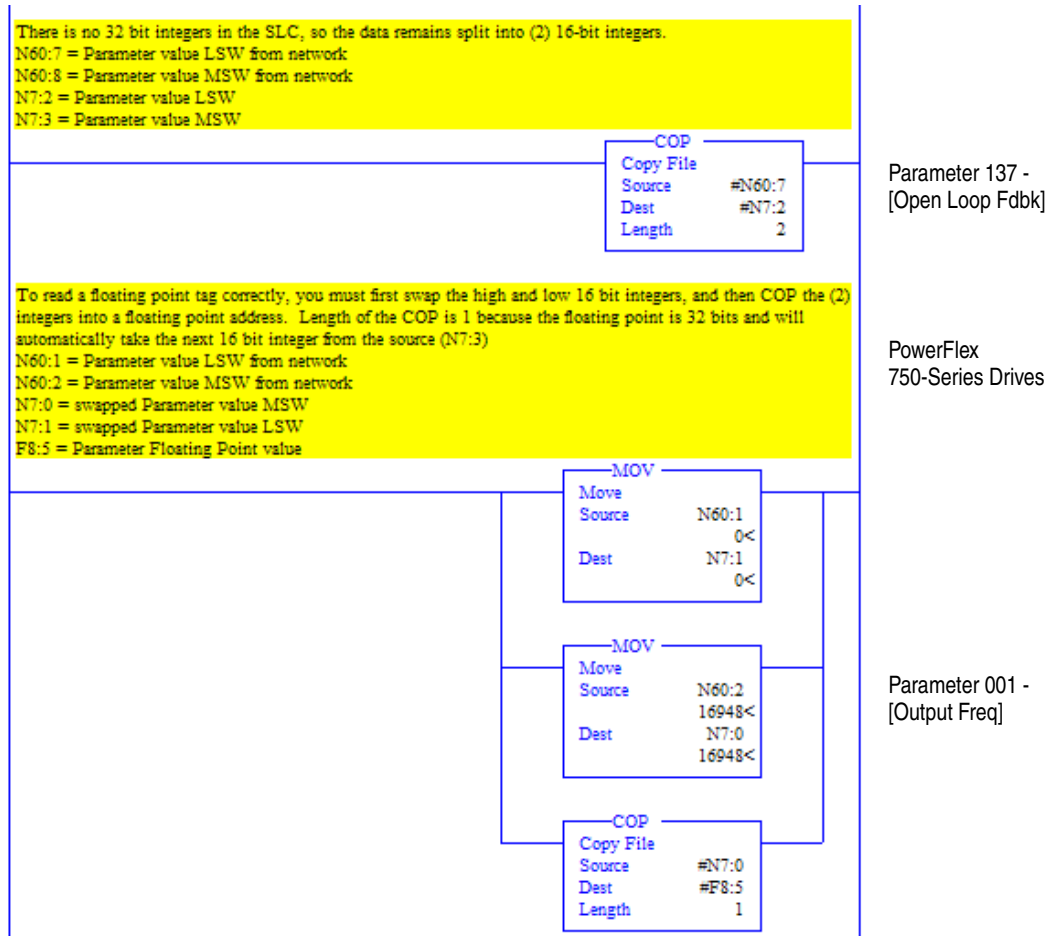

In this message example, the parameters have the following values.

PowerFlex 750-Series Drive Parameter	Read Value	Data Type
1 - [Output Freq]	45.0 Hz	REAL
7 - [Output Current]	0.04 Amp	REAL
137 - [Open Loop Fdbk]	710659711	DINT
21581 - [Port 5: Analog Out 0 Data]	45.0 Hz	REAL
260 - [Analog In0 Value]	9.361 Volts	REAL

### SLC 500 Controller Example Ladder Logic Program to Write Multiple Parameters Using Generic Get/Set Attribute Service

A Custom scattered write message is used to write to multiple parameters. This write message example writes the following values to these five parameters.

PowerFlex 7-Class Drive Parameter	Write Value	PowerFlex 750-Series Drive Parameter	Write Value
141 - [Accel Time 2]	11.1 Sec.	536 - [Accel Time 2]	11.1 Sec.
143 - [Decel Time 2]	22.2 Sec.	538 - [Decel Time 2]	22.2 Sec.
105 - [Preset Speed 5]	33.3 Hz.	725 - [Zero Position]	33
106 - [Preset Speed 6]	44.4 Hz.	21555 - [Port 5: Analog In0 Hi]	5.5
107 - [Preset Speed 7]	55.5 Hz.	780 - [PTP Setpoint]	-75,555

See [DPI Parameter Object on page C-16](#) (Class code 0x93) or [Host DPI Parameter Object on page C-30](#) (Class code 0x9F) for parameter numbering.

**Important:** See [Table 6.A on page 6-2](#) for limitations of PowerFlex 7-Class and PowerFlex 750-Series drives when using DPI Parameter Object Class code 0x93 or Host DPI Parameter Object Class code 0x9F for explicit messaging.

**Figure 6.75 Example Ladder Logic to Write Multiple Parameters**

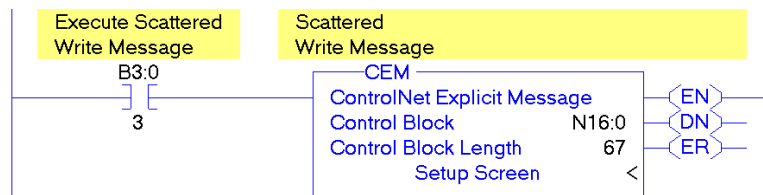

**Important:** If the explicit message scattered write must be written continuously, then use a separate Generic Set service explicit message single write for each parameter using DPI Parameter Object Class code 0x93 or Host DPI Parameter Object Class code 0x9F and attribute A (10 decimal; see [page 6-51](#)). Attribute A writes to RAM—not NVS (EEPROM) memory. This example scattered write message using attribute 0 writes to NVS. Over time, continuous writes will exceed the EEPROM life cycle and cause the drive to malfunction.

### SLC 500 Controller – Formatting a Message to Write Multiple Parameters Using Generic Get/Set Attribute Service

**Figure 6.76 Custom Scattered Write Multiple Message Configuration Screen**

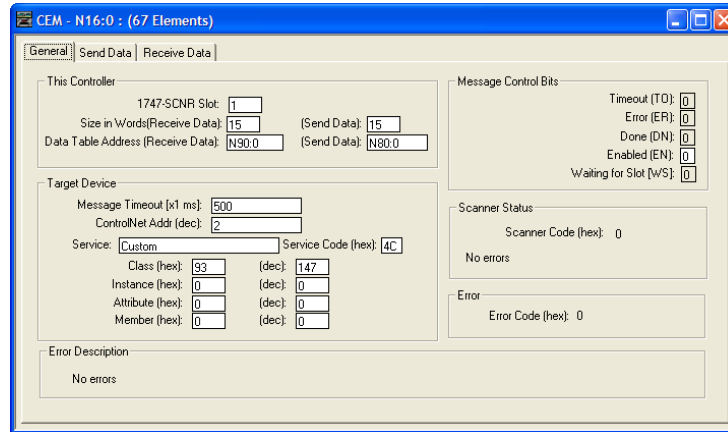

The following table identifies the data that is required in each box to configure a message to write multiple parameters.

General Tab	Example Value	Description
1747-SCNR Slot	1	The chassis slot occupied by the scanner.
Size in Words (Receive Data)	15 <sup>(2)</sup>	Number of words to be received. Each word size is a 16-bit integer.
Size in Words (Send Data)	15 <sup>(2)</sup>	Number of words to be sent (written). Each word size is a 16-bit integer.
Data Table Address (Receive Data)	N90:0	An unused controller data table address containing the message instruction. This address is the starting word of the destination file.
Data Table Address (Send Data)	N80:0	An unused controller data table address containing the message instruction. This address is the starting word of the source file.
Message Timeout	500	The time (in milliseconds) that the message must be completed.
ControlNet Addr	2	The node address of the adapter connected to the drive.
Service <sup>(1)</sup>	Custom	Required for scattered messages.
Service Code	4C (Hex.)	Code for the requested service.
Class	93 or 9F (Hex.) <sup>(3)</sup>	Class ID for the DPI Parameter Object.
Instance	0 (Dec.)	Required for scattered messages.
Attribute	0 (Dec.)	Required for scattered messages.

- <sup>(1)</sup> The default setting for Service is 'Custom', enabling entry of a Service Code not available from the Service pull-down menu. When choosing a Service other than 'Custom' from the pull-down menu, an appropriate Hex. value is automatically assigned to the Service Code box which is dimmed (unavailable).
- <sup>(2)</sup> In this example, we are writing to five parameters. Each parameter being written to requires three contiguous 16-bit words. Scattered write messages always assume that every parameter being written to is a 32-bit integer, regardless of its actual data type. The data structure format is the same as shown on [page 6-53](#). Maximum length is 66 words, which equates to 22 parameters. For parameter numbering, see [DPI Parameter Object on page C-16](#) (Class code 0x93) or [Host DPI Parameter Object on page C-30](#) (Class code 0x9F).
- <sup>(3)</sup> See [Table 6.A on page 6-2](#) for limitations of PowerFlex 7-Class and PowerFlex 750-Series drives when using DPI Parameter Object Class code 0x93 or Host DPI Parameter Object Class code 0x9F for explicit messaging.

### SLC 500 Controller Example Scattered Write Request Data

In this message example, we use the data table addresses in [Figure 6.77](#) or [Figure 6.80](#) to store the request values to be written to these drive parameters.

PowerFlex 7-Class Drive Parameter	Address	Write Value	PowerFlex 750-Series Drive Parameter	Write Value	Data Type
141 - [Accel Time 2]	N90:1	11.1 Sec.	536 - [Accel Time 2]	11.1 Sec.	REAL
143 - [Decel Time 2]	N90:4	22.2 Sec.	538 - [Decel Time 2]	22.2 Sec.	REAL
105 - [Preset Speed 5]	N90:7	33.3 Hz.	725 - [Zero Position]	33	32-bit integer
106 - [Preset Speed 6]	N90:10	44.4 Hz.	21555 - [Port 5: Analog In0 Hi]	5.5	REAL
107 - [Preset Speed 7]	N90:13	55.5 Hz.	780 - [PTP Setpoint]	-75,555	32-bit integer

See [DPI Parameter Object on page C-16](#) (Class code 0x93) or [Host DPI Parameter Object on page C-30](#) (Class code 0x9F) for parameter numbering.

[Figure 6.77](#) or [Figure 6.80](#) shows the parameter values.

**Figure 6.77 Example Scattered Write Request Data File for PowerFlex 7-Class Drive**

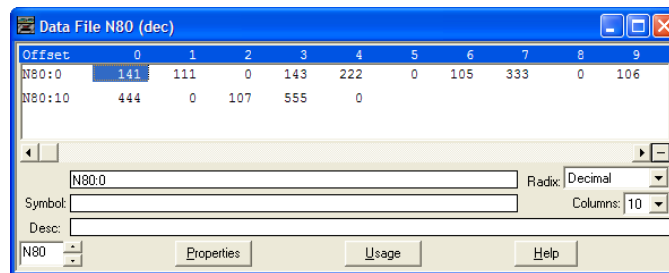

### SLC 500 Controller Example Scattered Write Response Data

In this message example, we use the data table addresses in [Figure 6.78](#) to store the response values that were written to the requested drive parameters. Values of '0' indicate no errors occurred.

**Figure 6.78 Example Scattered Write Response Data File for PowerFlex 7-Class Drive**

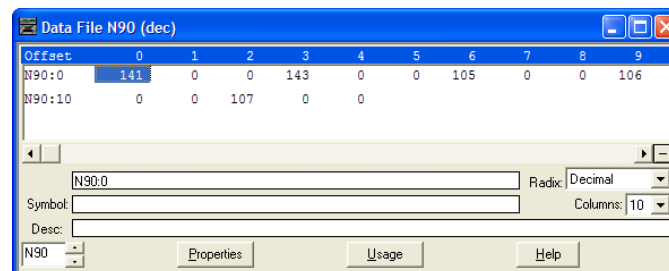

The PowerFlex 750-Series drive uses 32-bit integer and REAL parameters. A COP command must be used to copy the 16-bit integer or REAL values to the N90 integer array. [Figure 6.79](#) shows the ladder logic used for this example. If the parameter data type is a 32-bit integer, the data remains split into two 16-bit integers since there are no 32-bit integers in the SLC 500

controller. If the parameter data type is a REAL, the floating point value in the SLC 500 controller is copied (COP) to two 16-bit integers. Then the MSW (most significant word) and LSW (least significant word) must be swapped before moving (MOV) the values to the array to be written to. See the drive documentation to determine the parameter data type (32-bit integer or REAL).

**Figure 6.79 Example Ladder Logic to Copy Request Data for PowerFlex 750-Series Drive**

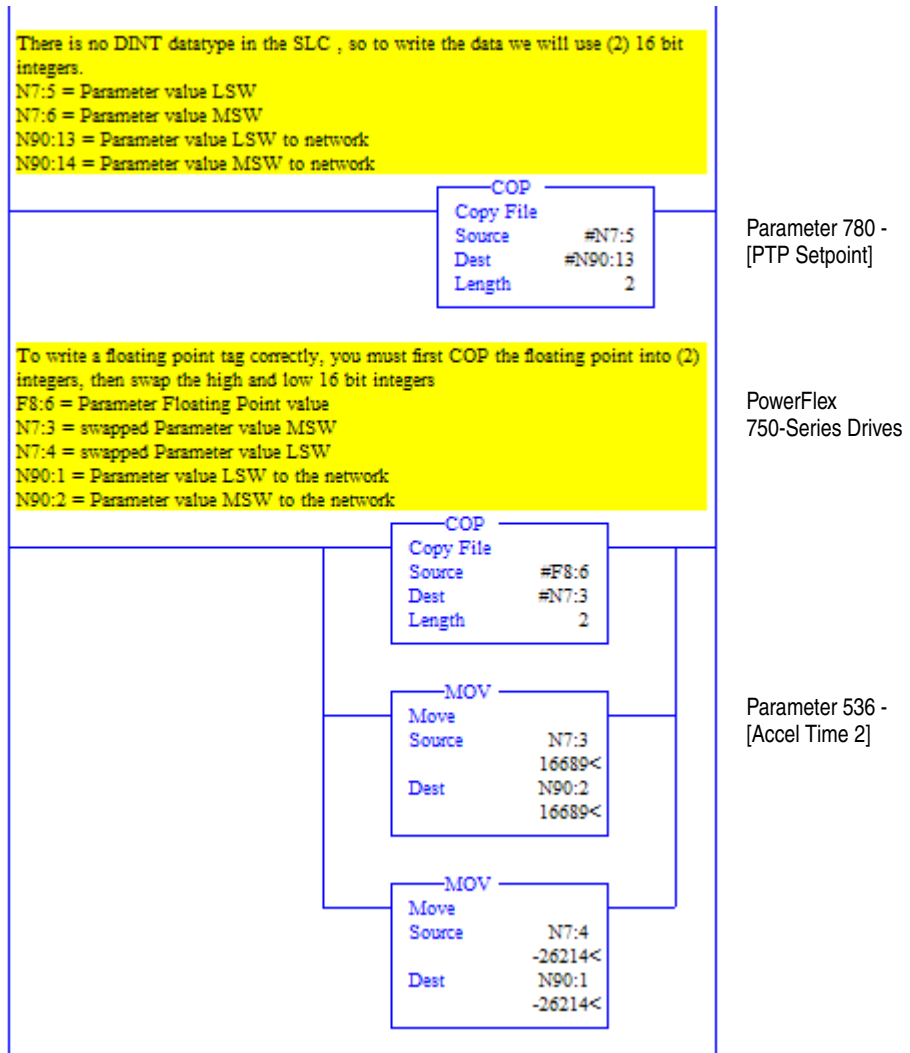

**Figure 6.80 Example Scattered Write Request Data File for PowerFlex 750-Series Drive**

Offset	0	1	2	3	4	5	6	7	8	9
N90:0	536	-26214	16689	538	-26214	16817	725	33	0	21555
N90:10	0	16560	780	-10019	-2					

Symbol:  Radix:  Columns:

Desc:

N90

The results of the explicit message appear in the destination tag array N80 (Figure 6.81). Values of '0' indicate no errors occurred.

**Figure 6.81 Example Scattered Write Response Data File for PowerFlex 750-Series Drive**

Offset	0	1	2	3	4	5	6	7	8	9
N80:0	536	0	0	538	0	0	725	0	0	21555
N80:10	0	0	780	0	0					

Symbol:  Radix:  Columns:

Desc:

N80

**Notes:**



# Troubleshooting

This chapter provides information for diagnosing and troubleshooting potential problems with the adapter and network.

Topic	Page
<a href="#">Understanding the Status Indicators</a>	<a href="#">7-1</a>
<a href="#">PORT Status Indicator</a>	<a href="#">7-2</a>
<a href="#">MOD Status Indicator</a>	<a href="#">7-2</a>
<a href="#">NET A and NET B Status Indicators</a>	<a href="#">7-3</a>
<a href="#">Viewing Adapter Diagnostic Items</a>	<a href="#">7-4</a>
<a href="#">Viewing and Clearing Events</a>	<a href="#">7-6</a>

## Understanding the Status Indicators

The adapter has four status indicators. They can be viewed on the adapter or through the drive cover.

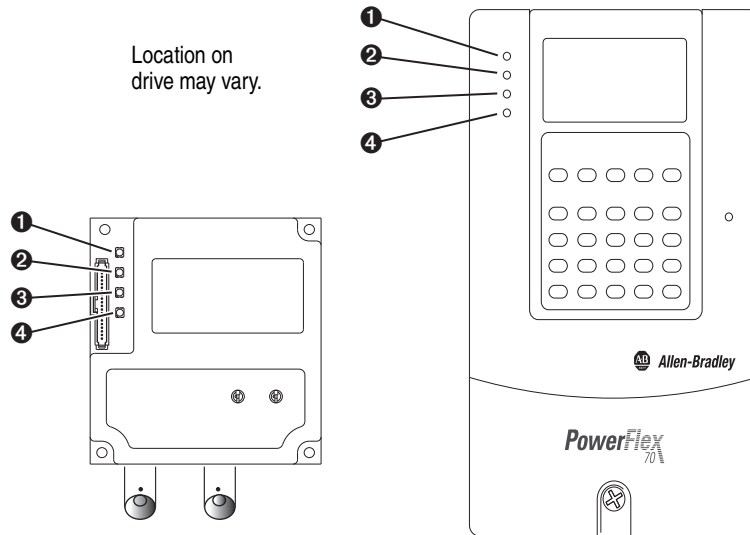

Item	Indicator Name	Description	See
1	PORT	DPI Connection Status	<a href="#">page 7-2</a>
2	MOD	Adapter Status	<a href="#">page 7-2</a>
3	NET A	ControlNet Channel A Status	<a href="#">page 7-3</a>
4	NET B	ControlNet Channel B Status	<a href="#">page 7-3</a>

**PORT Status Indicator**

This red/green bicolor LED indicates the status of the adapter's connection to the drive as shown in the table below.

Status	Cause	Corrective Action
Off	The adapter is not powered or is not properly connected to the drive.	<ul style="list-style-type: none"> <li>Securely connect the adapter to the drive using the Internal Interface (ribbon) cable.</li> <li>Apply power to the drive (or adapter if mounted in a DPI External Comms Kit).</li> </ul>
Flashing Red	The adapter is not receiving a ping message from the drive.	<ul style="list-style-type: none"> <li>Verify that cables are securely connected and not damaged. Replace cables if necessary.</li> <li>Cycle power to the drive (or adapter if mounted in a DPI External Comms Kit).</li> </ul>
Steady Red	The drive has refused an I/O connection from the adapter.  Another DPI peripheral is using the same DPI port as the adapter.	<p><b>Important:</b> Cycle power to the drive (or adapter if mounted in a DPI External Comms Kit) after making any of the following corrections:</p> <ul style="list-style-type: none"> <li>Verify that all DPI cables on the drive are securely connected and not damaged. Replace cables if necessary.</li> <li>Verify that the DPI drive supports Datalinks.</li> <li>Configure the adapter to use a Datalink that is not already being used by another peripheral.</li> </ul>
Steady Orange	The adapter is connected to a product that does not support Allen-Bradley DPI communications.	Connect the adapter to a product that supports Allen-Bradley DPI communications (for example, a PowerFlex 7-Class drive).
Flashing Green	The adapter is establishing an I/O connection to the drive.	No action required. Normal behavior if no DPI I/O is enabled.
Steady Green	The adapter is properly connected and is communicating with the drive.	No action required.

**MOD Status Indicator**

This red/green bicolor LED indicates the status of the adapter as shown in the table below.

Status	Cause	Corrective Action
Off	The adapter is not powered or is not properly connected to the drive.	<ul style="list-style-type: none"> <li>Securely connect the adapter to the drive using the Internal Interface (ribbon) cable.</li> <li>Apply power to the drive (or adapter if mounted in a DPI External Comms Kit).</li> </ul>
Flashing Red	The adapter has failed the firmware test.  The adapter firmware is being updated.	<ul style="list-style-type: none"> <li>Clear faults in the adapter.</li> <li>Cycle power to the drive (or adapter if mounted in a DPI External Comms Kit).</li> <li>If cycling power does not correct the problem, the adapter parameter settings may have been corrupted. Reset defaults and reconfigure the adapter.</li> <li>If resetting defaults does not correct the problem, update the adapter with the latest firmware revision.</li> </ul>
Steady Red	The adapter has failed the hardware test.	<ul style="list-style-type: none"> <li>Cycle power to the drive (or adapter if mounted in a DPI External Comms Kit).</li> <li>Replace the adapter.</li> </ul>
Flashing Green	The adapter is operational, but is not transferring I/O data to a controller.	<ul style="list-style-type: none"> <li>Place the scanner in RUN mode.</li> <li>Program the controller to recognize and transmit I/O to the adapter.</li> <li>Configure the adapter for the program in the controller.</li> <li>Normal behavior if no DPI I/O is enabled.</li> </ul>
Steady Green	The adapter is operational and transferring I/O data to a controller.	No action required.

## NET A and NET B Status Indicators

These red/green bicolor LEDs indicate the status for the ControlNet Channel A and Channel B network connections as shown in the tables below. Depending on the state of these LEDs, they should be interpreted together or independently.

### Indicators Interpreted Together

Status	Cause	Corrective Actions
Both LEDs Off	A reset occurred or the adapter is not powered.	Apply power to the drive (or adapter if mounted in a DPI External Comms Kit) and network.
Both LEDs Steady Red	A link interface failed.	<ul style="list-style-type: none"> <li>• Check media for broken cables, loose connectors, missing terminators, and so forth.</li> <li>• Cycle power to the drive (or adapter if mounted in a DPI External Comms Kit) or reset the adapter. If the problem persists, contact Rockwell Technical Support.</li> </ul>
LEDs Alternately Flashing Red/Green	The adapter is in self-test mode.	No action required. The adapter will exit this mode when the self-test is completed.
LEDs Alternately Flashing Red/Off	There is a bad node configuration.	<ul style="list-style-type: none"> <li>• Verify that all node addresses are unique.</li> <li>• Check the adapter's configuration.</li> <li>• Check media for broken cables, loose connectors, missing terminators, etc.</li> <li>• Cycle power to the drive (or adapter if mounted in a DPI External Comms Kit) or reset the adapter.</li> </ul>

### Indicator Interpreted Independently

Status	Cause	Corrective Actions
One channel LED is Steady Off.	That channel is disabled or not supported.	Program the network for redundant media, if required.
One channel LED is Flashing Red/Green.	There is an invalid link configuration for that channel.	<ul style="list-style-type: none"> <li>• Cycle power to the drive (or adapter if mounted in a DPI External Comms Kit) or reset the adapter.</li> <li>• Reset the controller.</li> <li>• If the problem persists, contact Rockwell Technical Support.</li> </ul>
One channel LED is Flashing Red/Off.	The channel is not receiving network activity.	Check media for broken cables, loose connectors, missing terminators, and so forth.
One channel LED is Flashing Green/Off.	A temporary channel error has occurred, or the channel is in listen-only mode.	Verify the controller is present on the network and working.
One channel LED is Steady Green.	Normal operation for that channel.	No action required.

## Viewing Adapter Diagnostic Items

If you encounter unexpected communications problems, the adapter’s diagnostic items may help you or Rockwell Automation personnel troubleshoot the problem. Adapter diagnostic items can be viewed with any of these drive configuration tools:

- LCD PowerFlex 7-Class HIM (Diagnostics/Device Items)
- Connected Components Workbench software, version 1.02 or later
- DriveExplorer software, version 2.01 or later
- DriveExecutive software, version 3.01 or later

### Using the HIM to View Adapter Diagnostic Items

Step	Example Screen
1. Access parameters in the adapter. See <a href="#">Using the PowerFlex 7-Class HIM to Access Parameters on page 3-2</a> . 2. Press the ▲ or ▼ key to scroll to <b>Diagnostics</b> . 3. Press the ↵ (Enter) key to display the Diagnostics menu in the adapter. 4. Repeat steps 2 and 3 to enter the <b>Device Items</b> option. 5. Press the ▲ or ▼ key to scroll through the items.	<p>The example screen shows two parts. The top part is a 'Main Menu' with options: 'Diagnostics' (highlighted), 'Parameter', and 'Device Select'. The bottom part shows 'Device Item #' as 3 and 'Reference'.</p>

**Table 7.A Adapter Diagnostic Items**

No.	Name	Description
1	Common Logic Cmd	The present value of the Common Logic Command being transmitted to the drive by this adapter.
2	Prod Logic Cmd	The present value of the Product Logic Command being transmitted to the drive by this adapter from the controller.
3	Reference	The present value of the Reference being transmitted to the drive by this adapter. Note that a 16-bit value will be sent as the Most Significant Word of the 32-bit field.
4	Common Logic Sts	The present value of the Common Logic Status being received from the drive by this adapter.
5	Prod Logic Sts	The present value of the Product Logic Status being received from the drive by this adapter from the controller.
6	Feedback	The present value of the Feedback being received from the drive by this adapter. Note that a 16-bit value will be sent as the Most Significant Word of the 32-bit field.
7	Datalink A1 In	The present value of respective Datalink In being transmitted to the drive by this adapter. (If not using a Datalink, this parameter should have a value of zero.)
8	Datalink A2 In	
9	Datalink B1 In	
10	Datalink B2 In	
11	Datalink C1 In	
12	Datalink C2 In	
13	Datalink D1 In	
14	Datalink D2 In	

**Table 7.A Adapter Diagnostic Items (Continued)**

No.	Name	Description
15	Datalink A1 Out	The present value of respective Datalink Out being received from the drive by this adapter. (If the drive indicates a 16-bit datalink size, the value appears in the least significant 16 bits of this diagnostic item, and the most significant 16 bits of this diagnostic item are zero.)
16	Datalink A2 Out	
17	Datalink B1 Out	
18	Datalink B2 Out	
19	Datalink C1 Out	
20	Datalink C2 Out	
21	Datalink D1 Out	
22	Datalink D2 Out	
23	DPI Rx Errors	The present value of the DPI Receive error counter.
24	DPI Rx Error Max	The maximum value (since reset) of the DPI Receive error counter.
25	DPI Tx Errors	The present value of the DPI Transmit error counter.
26	DPI Tx Error Max	The maximum value (since reset) of the DPI Transmit error counter.
27	Node Address SW	The present value of the adapter node address switches.
28	Boot Flash Count	The number of times the boot firmware in the adapter has been updated.
29	App Flash Count	The number of times the application firmware in the adapter has been updated.
30	M-S Input Size	The size of data transferred from the network to the drive.
31	M-S Output Size	The size of data transferred from the drive to the network.
32	OPT Status	The operating status of optional I/O board in the DPI External Comms Kit. For the meanings of the individual bits, see <a href="#">Viewing Optional I/O Diagnostic Items on page 8-4</a> .
33	OPT RX Errors	Number of optional I/O board receive errors.
34	OPT FW Version	Firmware version of optional I/O board (in DPI External Comms Kit).

## Viewing and Clearing Events

The adapter has an event queue to record significant events that occur in the operation of the adapter. When such an event occurs, an entry is put into the event queue. You can view the event queue with any of these drive configuration tools:

- LCD PowerFlex 7-Class HIM
- Connected Components Workbench software, version 1.02 or later
- DriveExplorer software, version 2.01 or later
- DriveExecutive software, version 1.01 or later

The event queue can contain up to 32 entries. Eventually the event queue will become full, since its contents are retained through adapter resets. At that point, a new entry replaces the oldest entry. Only an event queue clear operation or adapter power cycle will clear the event queue contents.

Resetting the adapter to defaults has no effect on the event queue.

### Using the HIM to View and Clear Events

Step	Example Screen
<p><b>Viewing Events</b></p> <ol style="list-style-type: none"> <li>1. Access parameters in the adapter. See <a href="#">Using the PowerFlex 7-Class HIM to Access Parameters on page 3-2</a>.</li> <li>2. Press the ▲ or ▼ key to scroll to <b>Diagnostics</b>.</li> <li>3. Press the ↵ (Enter) key to display the Diagnostics menu in the adapter.</li> <li>4. Repeat steps 2 and 3 to enter the <b>Events</b> option and then <b>View Event Queue</b> option.</li> <li>5. Press the ▲ or ▼ key to scroll through events. The most recent event is Event 1.</li> </ol> <p><b>Clearing Events</b></p> <ol style="list-style-type: none"> <li>1. Access parameters in the adapter. See <a href="#">Using the PowerFlex 7-Class HIM to Access Parameters on page 3-2</a>.</li> <li>2. Press the ▲ or ▼ key to scroll to <b>Diagnostics</b>.</li> <li>3. Press the ↵ (Enter) key to display the Diagnostics menu in the adapter.</li> <li>4. Repeat steps 2 and 3 to enter the <b>Events</b> option and then the <b>Clear Event</b> option or <b>Clr Event Queue</b> option. A message will pop up to confirm that you want to clear the message or queue.</li> <li>5. Press the ↵ (Enter) key to confirm your request. If <b>Clr Event Queue</b> was selected, all event queue entries will then display 'No Event'.</li> </ol>	<div data-bbox="1182 930 1414 1052" style="border: 1px solid black; padding: 5px;">                     Main Menu:  <b>Diagnostics</b>                      Parameter                      Device Select                 </div> <div data-bbox="1182 1125 1414 1247" style="border: 1px solid black; padding: 5px;">                     Event Q: <b>1</b> E3                      Ping Time Fit                 </div> <div data-bbox="1182 1465 1414 1587" style="border: 1px solid black; padding: 5px;">                     Dgn: Events                      View Event Queue                      Clear Event  <b>Clr Event Queue</b> </div>

## Events

Many events in the event queue occur under normal operation. If you encounter unexpected communications problems, the events may help you or Allen-Bradley personnel troubleshoot the problem. The following events may appear in the event queue.

**Table 7.B Adapter Events**

Code	Event	Description
1	No Event	Empty event queue entry.
2	DPI Bus Off Flt	A bus-off condition was detected on DPI. This event may be caused by loose or broken cables or by noise.
3	Ping Time Flt	A ping message was not received on DPI within the specified time.
4	Port ID Flt	The adapter is not connected to a correct port on a DPI product.
5	Port Change Flt	The DPI port changed after start up.
6	Host Sent Reset	The drive sent a reset event message.
7	EEPROM Sum Flt	The EEPROM in the adapter is corrupt.
8	Online @ 125kbps	The adapter detected that the drive is communicating at 125 kbps.
9	Online @ 500kbps	The adapter detected that the drive is communicating at 500 kbps.
10	Bad Host Flt	The adapter was connected to an incompatible product.
11	Dup Port Flt	Another peripheral with the same port number is already in use.
12	Type 0 Login	The adapter has logged in for Type 0 control.
13	Type 0 Time Flt	The adapter has not received a Type 0 status message within the specified time.
14	DL Login	The adapter has logged into a Datalink.
15	DL Reject Flt	The drive rejected an attempt to log in to a Datalink because the Datalink is not supported or is used by another peripheral.
16	DL Time Flt	The adapter has not received a Datalink message within the specified time.
17	Reserved	Not used.
18	Control Disabled	The adapter has sent a 'Soft Control Disable' command to the drive.
19	Control Enabled	The adapter has sent a 'Soft Control Enable' command to the drive.
20	Message Timeout	A Client-Server message sent by the adapter was not completed within 1 sec.
21	Flt Cfg Error	One of the Flt Cfg xx parameters is set to a value greater than 65535 and the drive requires a 16-bit value.
22	App CRC Flt	Startup sequence detected corrupt application firmware.
23	App Updated	New application firmware was detected.
24	CN Comm Flt	The adapter detected a communications fault on the network.
25	CN Sent Reset	The adapter received a reset from the network.
26	CN Close Flt	An I/O connection from the network to the adapter was closed.
27	CN Idle Flt	The adapter is receiving 'idle' packets from the network.
28	CN Open	An I/O connection from the network to the adapter has been opened.
29	CN Timeout Flt	An I/O connection from the network to the adapter has timed out.
30	PCCC IO Close	The device sending PCCC Control messages to the adapter has set the PCCC Control Timeout to zero.
31	PCCC IO Open	The adapter has begun receiving PCCC control messages (the PCCC Control Timeout was previously set to a non-zero value).
32	PCCC IO Time Flt	The adapter has not received a PCCC Control message for longer than the PCCC Control Timeout.
33	Watchdog T/O Flt	The software detects a failure.
34	EEPROM Init	Startup sequence detected a blank EEPROM map revision.
35	DPI Fault Clear	The drive issued this because a fault was cleared.
36	Normal Startup	The adapter successfully started up.
37	Manual Reset	The adapter was reset by changing its Reset Module parameter.
38	OPT Open	The adapter began exchanging I/O data with the I/O option of the DPI External Comms Kit.

**Table 7.B Adapter Events (Continued)**

<b>Code</b>	<b>Event</b>	<b>Description</b>
39	OPT Close	The adapter forced a fault condition on the I/O option of the DPI External Comms Kit.
40	OPT Timeout	Communication between the adapter and I/O option of the DPI External Comms Kit was disrupted.
41	CN Link Up	The adapter successfully joined the ControlNet network.
42	CN Link Down	The adapter lost its connection to the ControlNet network.
43	Dup CN Addr	The adapter detected a duplicate ControlNet node address.



## Using the Adapter in a DPI External Comms Kit (20-XCOMM-DC-BASE)

This chapter provides information and examples that explain how to use the adapter in a DPI External Comms Kit (20-XCOMM-DC-BASE).

The adapter is typically installed in the internal communication slot on the PowerFlex 7-Class drive. However, an externally-mounted adapter may be desired when:

- The PowerFlex drive is already connected to an existing network, such as Remote I/O, and a second network is desired for a DriveExplorer or DriveExecutive software tool, data collection, and so forth.
- The PowerFlex drive is remotely located next to some I/O devices that also need to be networked. The DPI External Comms Kit has an option slot for general-purpose network I/O that a controller can use. Both the drive and I/O devices are handled as one node on the network to reduce the network node count.

Topic	Page
<a href="#">Installing the Adapter</a>	8-1
<a href="#">I/O Board Option (20-XCOMM-IO-OPT1)</a>	8-2
<a href="#">Understanding the I/O Image (Drive + I/O Option)</a>	8-2
<a href="#">Configuring the Adapter to Use the Optional I/O Data</a>	8-3
<a href="#">Viewing Optional I/O Diagnostic Items</a>	8-4

### Installing the Adapter

The adapter can be installed in a DPI External Comms Kit.

**Figure 8.1 Mounting and Connecting the Adapter**

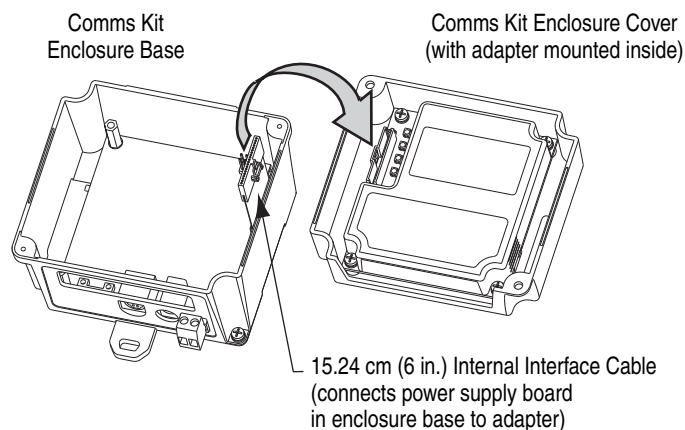

For more information, see the DPI External Communications Kit Installation Instructions, publication 20COMM-IN001.

### I/O Board Option (20-XCOMM-IO-OPT1)

The I/O Board option, when installed in the DPI External Comms Kit, can be used with only a Series B adapter, firmware revision 3.xxx or later. The I/O Board provides six DC inputs and two Relay outputs for use by a controller on the network.

**Figure 8.2 I/O Connector Function Descriptions**

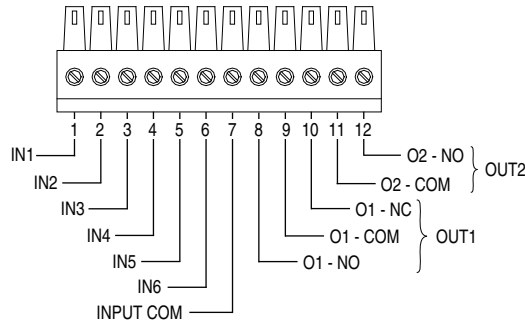

For more information, see the I/O Board Option Installation Instructions, publication 20COMM-IN002.

### Understanding the I/O Image (Drive + I/O Option)

The data for the optional I/O Board is sent over the I/O connection using Datalink D. When the optional I/O Board is installed in the DPI External Comms Kit, Datalink D is dedicated only for this function and is not available for other uses. When the adapter detects the presence of the optional I/O Board, the I/O image is modified as shown in [Figure 8.3](#).

**Figure 8.3 Example I/O Image - Datalink D Dedicated to I/O Board and All I/O Enabled**

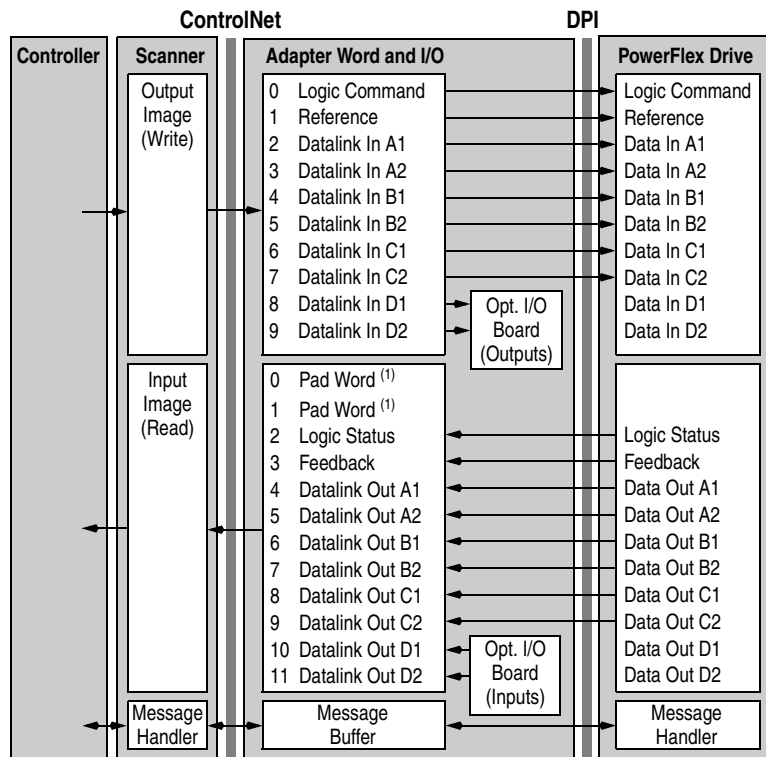

<sup>(1)</sup> Required by ControlLogix when using the Generic Profile. May or may not be required by other types of controllers.

The data from the I/O Board is loaded into the Datalink word starting with bit 0 of Datalink D1 and concluding with bit 14. Bit 15 of Datalink D1 is reserved as an input valid Status flag. When the input data is valid, bit 15 = 1.

For example, for the 20-XCOMM-IO-OPT1, the digital inputs and digital outputs are mapped as shown in [Figure 8.4](#) and [Figure 8.5](#) respectively.

**Figure 8.4 I/O Board Option Digital Input Mapping**

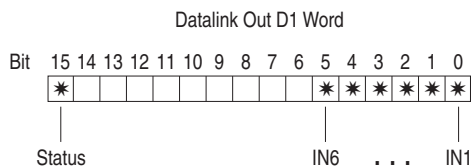

**Figure 8.5 I/O Board Option Digital Output Mapping**

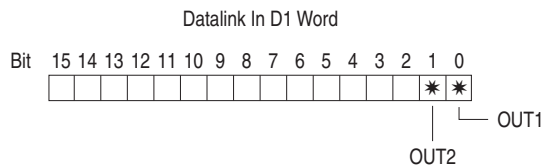

**Important:** On power-up or reset, the outputs will be in a ‘non-activated’ state.

## Configuring the Adapter to Use the Optional I/O Data

To configure the adapter to use the optional I/O Board, **Parameter 13 - [DPI I/O Cfg]**, **25 - [M-S Input]**, and **26 - [M-S Output]** must be set. To send input/output data from the optional I/O board to the network, do the following:

- Turn on bit 4 (1xxxx) in **Parameter 25 - [M-S Input]**
- Turn on bit 4 (1xxxx) in **Parameter 26 - [M-S Output]**
- Turn off bit 4 (0xxxx) in **Parameter 13 - [DPI I/O Cfg]**

Setting the Datalink D bit 4 in the M-S Input and M-S Output parameters directs the communication adapter to send Datalink D back to the controller. Turning off bit 4 in the DPI I/O Cfg parameter directs the communication adapter to not send Datalink D data back to the drive. For more information on I/O Messaging and Configuring Datalinks, see [Chapter 5, Using the I/O](#).

If the I/O Board Fault Action Jumper (JMP1) is set to the Fault Configurable position, **Parameter 23 - [Flt Cfg D1 In]** is used to set the states of the outputs when the I/O Board takes its Fault Action. For details on setting the Fault Action jumper, see the I/O Board Option Installation Instructions, publication 20COMM-IN002.

## Viewing Optional I/O Diagnostic Items

Viewing communication adapter diagnostic item 31 (OPT Status) shows the operating status of the optional I/O board.

Bit	State	Status Indication	Description
0	1 (On)	OPT Present	I/O data is being exchanged with the adapter.
1	1 (On)	OPT Faulted	The I/O board is taking its fault action.
2	1 (On)	Hold Last	Fault Action is 'Hold Last'.
3	1 (On)	Send Flt Cfg	Fault Action is 'Fault Config'.

Viewing communication adapter diagnostic item 32 (OPT RX Errors) shows the number of I/O board receive errors.

Viewing communication adapter diagnostic item 33 (OPT FW Version) shows the present firmware revision of the optional I/O board.

Diagnostic item 13 (Datalink D1 In) will show the status of the outputs as a combined decimal value. For example, a '0' decimal ('00' binary) indicates both outputs are off and a '3' decimal ('11' binary) indicates both outputs are on. **NOTE:** A status bit is not used for outputs.

Diagnostic item 21 (Datalink D1 Out) will show the status of the inputs as a combined decimal value, including the status bit 15. For example, [Figure 8.6](#) shows inputs that are valid and all on, and [Figure 8.7](#) shows inputs that are valid and all off (zero).

**Figure 8.6 Valid Inputs All On**

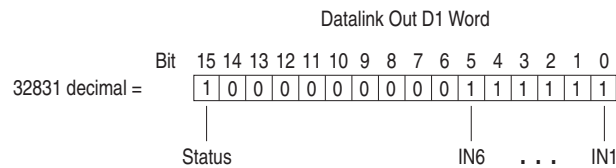

**Figure 8.7 Valid Inputs All Off**

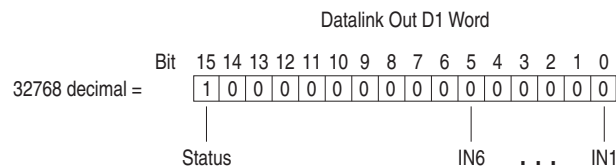

## Specifications

This appendix presents the specifications for the adapter.

Topic	Page
<a href="#">Communications</a>	<a href="#">A-1</a>
<a href="#">Electrical</a>	<a href="#">A-1</a>
<a href="#">Mechanical</a>	<a href="#">A-1</a>
<a href="#">Environmental</a>	<a href="#">A-2</a>
<a href="#">Regulatory Compliance</a>	<a href="#">A-2</a>

### Communications

Network Protocol	ControlNet
Data Rate	5 Mbps (fixed)
Media: 20-COMM-C	Coax with BNC connector
20-COMM-Q	Fiber with V-pin type connector
Connection Limits	20 simultaneous CIP messaging connections Unlimited input-only I/O connections One of the following connection types: <ul style="list-style-type: none"> <li>• 1 exclusive-owner I/O connection</li> <li>• Up to 3 redundant-owner I/O connections</li> <li>• 1 listen-only I/O connection</li> </ul>
Requested Packet Interval (RPI)	5 ms minimum
Packet Rate	Up to 400 total I/O packets per second (200 in and 200 out)
Drive Protocol	DPI
Data Rates	125 kbps or 500 kbps

### Electrical

Consumption	
Drive	275 mA at 5 V DC supplied by the host (drive or DPI External Comms Kit)
Network	None

### Mechanical

Dimensions	
Height	16 mm (0.62 inches)
Length	103 mm (4.00 inches)
Width	80 mm (3.12 inches)
Weight	85 g (3 oz.)

## Environmental

Temperature Operating Storage	-10...50 °C (14...122 °F) -40...85 °C (-40...185 °F)
Relative Humidity	5...95% non-condensing
Atmosphere	<b>Important:</b> The adapter <b>must not</b> be installed in an area where the ambient atmosphere contains volatile or corrosive gas, vapors or dust. If the adapter is not going to be installed for a period of time, it must be stored in an area where it will not be exposed to a corrosive atmosphere.

## Regulatory Compliance

Certification	Specification
UL	UL508C
cUL	CAN / CSA C22.2 No. 14-M91
CE	EN50178 and EN61800-3
CTick	EN61800-3



**NOTE:** This is a product of category C3 according to IEC 61800-3. It is not intended for operation in a domestic environment.

## Adapter Parameters

This appendix provides information about the adapter parameters. For configuration tools to monitor or change parameter values of the drive, adapter, and other connected peripherals, see [Configuration Tools on page 3-1](#).

### Parameter List

Parameter			
No.	Name and Description	Details	
01	<b>[DPI Port]</b> Displays the port to which the adapter is connected. This will usually be port 5.	Minimum: Maximum: Type:	0 7 Read Only
02	<b>[DPI Data Rate]</b> Displays the data rate used by the drive. This data rate is set in the drive and the adapter detects it.	Values: Type:	0 = 125 kbps 1 = 500 kbps Read Only
03	<b>[CN Addr Cfg]</b> Sets the ControlNet node address used by the adapter when the Node Address switches are set to '00'. (Updates <b>Parameter 04 - [CN Addr Act]</b> after reset).	Default: Minimum: Maximum: Type: Reset Required:	2 1 99 Read/Write Yes
04	<b>[CN Addr Act]</b> Displays the actual ControlNet node address used by the adapter.	Minimum: Maximum: Type:	1 99 Read Only
05	<b>[CN Rate Cfg]</b> Sets the network data rate (megabits per second) at which the adapter communicates. (Updates <b>Parameter 06 - [CN Rate Act]</b> after a reset.)	Default: Values: Type: Reset Required:	0 = 5 Mbps 0 = 5 Mbps Read/Write Yes
06	<b>[CN Rate Act]</b> Displays the actual network data rate (megabits per second) used by the adapter.	Values: Type:	0 = 5 Mbps Read Only
07	<b>[Ref/Fdbk Size]</b> Displays the size of the Reference/Feedback. The drive determines the size of the Reference/Feedback.	Values: Type:	0 = 16-bit 1 = 32-bit Read Only
08	<b>[Datalink Size]</b> Displays the size of each Datalink word. The drive determines the size of Datalinks.	Values: Type:	0 = 16-bit 1 = 32-bit Read Only

Parameter		
No.	Name and Description	Details
09	<p><b>[Reset Module]</b></p> <p>No action if set to '0' (Ready). Resets the adapter if set to '1' (Reset Module). Restores the adapter to its factory default settings if set to '2' (Set Defaults). This parameter is a command. It will be reset to '0' (Ready) after the command has been performed.</p>	<p>Default: 0 = Ready</p> <p>Values: 0 = Ready 1 = Reset Module 2 = Set Defaults</p> <p>Type: Read/Write</p> <p>Reset Required: No</p>
<p> <b>ATTENTION:</b> Risk of injury or equipment damage exists. If the adapter is transmitting I/O that controls the drive, the drive may fault when you reset the adapter. Determine how your drive will respond before resetting a connected adapter.</p>		
10	<p><b>[Comm Flt Action]</b></p> <p>Sets the action that the adapter and drive will take if the adapter detects that I/O communication has been disrupted. This setting is effective only if I/O that controls the drive is transmitted through the adapter. When communication is re-established, the drive will automatically receive commands over the network again.</p>	<p>Default: 0 = Fault</p> <p>Values: 0 = Fault 1 = Stop 2 = Zero Data 3 = Hold Last 4 = Send Flt Cfg</p> <p>Type: Read/Write</p> <p>Reset Required: No</p>
<p> <b>ATTENTION:</b> Risk of injury or equipment damage exists. <b>Parameter 10 - [Comm Flt Action]</b> lets you determine the action of the adapter and connected drive if I/O communication is disrupted. By default, this parameter faults the drive. You can set this parameter so that the drive continues to run, however, precautions should be taken to verify that the setting of this parameter does not create a risk of injury or equipment damage. When commissioning the drive, verify that your system responds correctly to various situations (for example, a disconnected cable).</p>		
11	<p><b>[Idle Flt Action]</b></p> <p>Sets the action that the adapter and drive will take if the adapter detects that the controller is in program mode or faulted. This setting is effective only if I/O that controls the drive is transmitted through the adapter. When the controller is put back in Run mode, the drive will automatically receive commands over the network again.</p>	<p>Default: 0 = Fault</p> <p>Values: 0 = Fault 1 = Stop 2 = Zero Data 3 = Hold Last 4 = Send Flt Cfg</p> <p>Type: Read/Write</p> <p>Reset Required: No</p>
<p> <b>ATTENTION:</b> Risk of injury or equipment damage exists. <b>Parameter 11 - [Idle Flt Action]</b> lets you determine the action of the adapter and connected drive when the controller is idle. By default, this parameter faults the drive. You can set this parameter so that the drive continues to run, however, precautions should be taken to verify that the setting of this parameter does not create a risk of injury or equipment damage. When commissioning the drive, verify that your system responds correctly to various situations (for example, a faulted controller).</p>		
12	<p><b>[CN Active Cfg]</b></p> <p>Displays the source from which the adapter node address is taken. This will either be '0' (Switches) or '1' (EEPROM) in which the address from <b>Parameter 03 - [CN Addr Cfg]</b> is stored. The source is determined by the settings of the adapter Node Address switches.</p>	<p>Values: 0 = Switches 1 = EEPROM</p> <p>Type: Read Only</p>



Parameter																													
No.	Name and Description	Details																											
13	<p><b>[DPI I/O Cfg]</b></p> <p>Sets the I/O that is transferred through the adapter.</p>	<p>Default: xxx0 0001</p> <p>Bit Values: 0 = I/O Disabled 1 = I/O Enabled</p> <p>Type: Read/Write</p> <p>Reset Required: Yes</p> <table border="1"> <thead> <tr> <th>Bit Definition</th> <th>Not Used</th> <th>Not Used</th> <th>Not Used</th> <th>Datalink D</th> <th>Datalink C</th> <th>Datalink B</th> <th>Datalink A</th> <th>Cmd/Ref</th> </tr> </thead> <tbody> <tr> <td>Default</td> <td>x</td> <td>x</td> <td>x</td> <td>0</td> <td>0</td> <td>0</td> <td>0</td> <td>1</td> </tr> <tr> <td>Bit</td> <td>7</td> <td>6</td> <td>5</td> <td>4</td> <td>3</td> <td>2</td> <td>1</td> <td>0</td> </tr> </tbody> </table>	Bit Definition	Not Used	Not Used	Not Used	Datalink D	Datalink C	Datalink B	Datalink A	Cmd/Ref	Default	x	x	x	0	0	0	0	1	Bit	7	6	5	4	3	2	1	0
Bit Definition	Not Used	Not Used	Not Used	Datalink D	Datalink C	Datalink B	Datalink A	Cmd/Ref																					
Default	x	x	x	0	0	0	0	1																					
Bit	7	6	5	4	3	2	1	0																					
14	<p><b>[DPI I/O Act]</b></p> <p>Displays the I/O that the adapter is actively transmitting. The value of this parameter will usually be equal to the value of <b>Parameter 13 - [DPI I/O Cfg]</b>.</p>	<p>Bit Values: 0 = I/O Disabled 1 = I/O Enabled</p> <p>Type: Read Only</p> <table border="1"> <thead> <tr> <th>Bit Definition</th> <th>Not Used</th> <th>Not Used</th> <th>Not Used</th> <th>Datalink D</th> <th>Datalink C</th> <th>Datalink B</th> <th>Datalink A</th> <th>Cmd/Ref</th> </tr> </thead> <tbody> <tr> <td>Default</td> <td>x</td> <td>x</td> <td>x</td> <td>0</td> <td>0</td> <td>0</td> <td>0</td> <td>1</td> </tr> <tr> <td>Bit</td> <td>7</td> <td>6</td> <td>5</td> <td>4</td> <td>3</td> <td>2</td> <td>1</td> <td>0</td> </tr> </tbody> </table>	Bit Definition	Not Used	Not Used	Not Used	Datalink D	Datalink C	Datalink B	Datalink A	Cmd/Ref	Default	x	x	x	0	0	0	0	1	Bit	7	6	5	4	3	2	1	0
Bit Definition	Not Used	Not Used	Not Used	Datalink D	Datalink C	Datalink B	Datalink A	Cmd/Ref																					
Default	x	x	x	0	0	0	0	1																					
Bit	7	6	5	4	3	2	1	0																					
15	<p><b>[Flt Cfg Logic]</b></p> <p>Sets the Logic Command data that is sent to the drive if any of the following is true:</p> <ul style="list-style-type: none"> <li>• <b>Parameter 10 - [Comm Flt Action]</b> is set to '4' (Send Flt Cfg) and I/O communication is disrupted.</li> <li>• <b>Parameter 11 - [Idle Flt Action]</b> is set to '4' (Send Flt Cfg) and the controller is idle.</li> </ul> <p>The bit definitions will depend on the product to which the adapter is connected. See <a href="#">Appendix D</a> or the documentation for the drive being used.</p>	<p>Default: 0000 0000 0000 0000</p> <p>Minimum: 0000 0000 0000 0000</p> <p>Maximum: 1111 1111 1111 1111</p> <p>Type: Read/Write</p> <p>Reset Required: No</p>																											
16	<p><b>[Flt Cfg Ref]</b></p> <p>Sets the Reference data that is sent to the drive if any of the following is true:</p> <ul style="list-style-type: none"> <li>• <b>Parameter 10 - [Comm Flt Action]</b> is set to '4' (Send Flt Cfg) and I/O communication is disrupted.</li> <li>• <b>Parameter 11 - [Idle Flt Action]</b> is set to '4' (Send Flt Cfg) and the controller is idle.</li> </ul>	<p>Default: 0</p> <p>Minimum: 0</p> <p>Maximum: 4294967295</p> <p>Type: Read/Write</p> <p>Reset Required: No</p> <p><b>Important:</b> If the drive uses a 16-bit Reference, the most significant word of this value must be set to zero (0) or a fault will occur.</p>																											
17	<b>[Flt Cfg A1 In]</b>	Default: 0																											
18	<b>[Flt Cfg A2 In]</b>	Default: 0																											
19	<b>[Flt Cfg B1 In]</b>	Default: 0																											
20	<b>[Flt Cfg B2 In]</b>	Default: 0																											
21	<b>[Flt Cfg C1 In]</b>	Default: 0																											
22	<b>[Flt Cfg C2 In]</b>	Default: 0																											
23	<b>[Flt Cfg D1 In]</b>	Default: 0																											
24	<b>[Flt Cfg D2 In]</b>	Default: 0																											
	<p>Sets the data that is sent to the Datalink in the drive if any of the following is true:</p> <ul style="list-style-type: none"> <li>• <b>Parameter 10 - [Comm Flt Action]</b> is set to '4' (Send Flt Cfg) and I/O communication is disrupted.</li> <li>• <b>Parameter 11 - [Idle Flt Action]</b> is set to '4' (Send Flt Cfg) and the controller is idle.</li> </ul>	<p>Minimum: 0</p> <p>Maximum: 4294967295</p> <p>Type: Read/Write</p> <p>Reset Required: No</p> <p><b>Important:</b> If the drive uses 16-bit Datalinks, the most significant word of this value must be set to zero (0) or a fault will occur.</p>																											

Parameter																													
No.	Name and Description	Details																											
25	<p><b>[M-S Input]</b></p> <p>Sets the Master-Slave input data. This data is produced by the scanner and consumed by the adapter.</p>	<p>Default: xxx0 0001</p> <p>Bit Values: 0 = I/O Disabled 1 = I/O Enabled</p> <p>Type: Read/Write</p> <p>Reset Required: Yes</p> <table border="1"> <thead> <tr> <th>Bit Definition</th> <th>Not Used</th> <th>Not Used</th> <th>Not Used</th> <th>Datalink D Input</th> <th>Datalink C Input</th> <th>Datalink B Input</th> <th>Datalink A Input</th> <th>Cmd/Ref</th> </tr> </thead> <tbody> <tr> <td>Default</td> <td>x</td> <td>x</td> <td>x</td> <td>0</td> <td>0</td> <td>0</td> <td>0</td> <td>1</td> </tr> <tr> <td>Bit</td> <td>7</td> <td>6</td> <td>5</td> <td>4</td> <td>3</td> <td>2</td> <td>1</td> <td>0</td> </tr> </tbody> </table>	Bit Definition	Not Used	Not Used	Not Used	Datalink D Input	Datalink C Input	Datalink B Input	Datalink A Input	Cmd/Ref	Default	x	x	x	0	0	0	0	1	Bit	7	6	5	4	3	2	1	0
Bit Definition	Not Used	Not Used	Not Used	Datalink D Input	Datalink C Input	Datalink B Input	Datalink A Input	Cmd/Ref																					
Default	x	x	x	0	0	0	0	1																					
Bit	7	6	5	4	3	2	1	0																					
26	<p><b>[M-S Output]</b></p> <p>Sets the Master-Slave output data. This data is produced by the adapter and consumed by the Master device (for example, scanner).</p>	<p>Default: xxx0 0001</p> <p>Bit Values: 0 = I/O Disabled 1 = I/O Enabled</p> <p>Type: Read/Write</p> <p>Reset Required: Yes</p> <table border="1"> <thead> <tr> <th>Bit Definition</th> <th>Not Used</th> <th>Not Used</th> <th>Not Used</th> <th>Datalink D Output</th> <th>Datalink C Output</th> <th>Datalink B Output</th> <th>Datalink A Output</th> <th>Cmd/Ref</th> </tr> </thead> <tbody> <tr> <td>Default</td> <td>x</td> <td>x</td> <td>x</td> <td>0</td> <td>0</td> <td>0</td> <td>0</td> <td>1</td> </tr> <tr> <td>Bit</td> <td>7</td> <td>6</td> <td>5</td> <td>4</td> <td>3</td> <td>2</td> <td>1</td> <td>0</td> </tr> </tbody> </table>	Bit Definition	Not Used	Not Used	Not Used	Datalink D Output	Datalink C Output	Datalink B Output	Datalink A Output	Cmd/Ref	Default	x	x	x	0	0	0	0	1	Bit	7	6	5	4	3	2	1	0
Bit Definition	Not Used	Not Used	Not Used	Datalink D Output	Datalink C Output	Datalink B Output	Datalink A Output	Cmd/Ref																					
Default	x	x	x	0	0	0	0	1																					
Bit	7	6	5	4	3	2	1	0																					
27	<p><b>[Ref Adjust]</b></p> <p>Sets the percent scale factor for the Reference received from the network.</p>	<p>Default: 100.00%</p> <p>Minimum: 0.00%</p> <p>Maximum: 200.00%</p> <p>Type: Read/Write</p> <p>Reset Required: No</p>																											
		<p> <b>ATTENTION:</b> To guard against equipment damage and/or personal injury, note that changes to <b>Parameter 27 - [Ref Adjust]</b> take effect immediately. A drive receiving its Reference from the adapter will receive the newly scaled Reference, resulting in a change of speed.</p>																											

## ControlNet Objects

This appendix presents information about the ControlNet objects that can be accessed using Explicit Messages. For information on the format of Explicit Messages and example ladder logic programs, see [Chapter 6, Using Explicit Messaging](#).

Object	Class Code		Page	Object	Class Code		Page
	Hex.	Dec.			Hex.	Dec.	
<a href="#">Identity Object</a>	0x01	1	<a href="#">C-2</a>	<a href="#">DPI Parameter Object</a>	0x93	147	<a href="#">C-16</a>
<a href="#">Assembly Object</a>	0x04	4	<a href="#">C-3</a>	<a href="#">DPI Fault Object</a>	0x97	151	<a href="#">C-22</a>
<a href="#">Register Object</a>	0x07	7	<a href="#">C-4</a>	<a href="#">DPI Alarm Object</a>	0x98	152	<a href="#">C-24</a>
<a href="#">Parameter Object</a> <sup>(1)</sup>	0x0F	15	<a href="#">C-5</a>	<a href="#">DPI Diagnostic Object</a>	0x99	153	<a href="#">C-26</a>
<a href="#">Parameter Group Object</a> <sup>(1)</sup>	0x10	16	<a href="#">C-7</a>	<a href="#">DPI Time Object</a>	0x9B	155	<a href="#">C-28</a>
<a href="#">PCCC Object</a>	0x67	103	<a href="#">C-8</a>	<a href="#">Host DPI Parameter Object</a> <sup>(2)</sup>	0x9F	159	<a href="#">C-30</a>
<a href="#">DPI Device Object</a>	0x92	146	<a href="#">C-13</a>				

<sup>(1)</sup> These objects are **not** supported when the adapter is used with a PowerFlex 750-Series drive.

<sup>(2)</sup> This object is supported only when the adapter is used with a PowerFlex 750-Series drive.



**TIP:** See the ControlNet specification for more information about ControlNet objects. Information about the ControlNet specification is available on the ODVA website (<http://www.odva.org>).

### Supported Data Types

Data Type	Description
BOOL	8-bit value -- low bit is true or false
BOOL[n]	Array of n bits
BYTE	8-bit unsigned integer
CONTAINER	32-bit parameter value - sign extended if necessary
DINT	32-bit signed integer
DWORD	32-bit unsigned integer
INT	16-bit signed integer
LWORD	64-bit unsigned integer
REAL	32-bit floating point
SHORT_STRING	1-byte length indicator + that many characters
SINT	8-bit signed integer
STRING[n]	Array of n characters
STRUCT	Structure name only - no size in addition to elements
TCHAR	8 or 16-bit character
UDINT	32-bit unsigned integer
UINT	16-bit unsigned integer
USINT	8-bit unsigned integer
WORD	16-bit unsigned integer

## Identity Object

### Class Code

Hexadecimal	Decimal
0x01	1

### Services

Service Code	Implemented for:		Service Name
	Class	Instance	
0x01	Yes	Yes	Get_Attributes_All
0x05	Yes	Yes	Reset
0x0E	Yes	Yes	Get_Attribute_Single

### Instances

The number of instances depends on the number of components in the device connected to the adapter. This number of components can be read in Instance 0, Attribute 2.

Instance	Description
0	Class
1	Host
2...15	Peripherals on Ports 1...14

### Class Attributes

Attribute ID	Access Rule	Name	Data Type	Description
2	Get	Max Instance	WORD	Total number of instances

### Instance Attributes

Attribute ID	Access Rule	Name	Data Type	Description
1	Get	Vendor ID	WORD	1 = Allen-Bradley
2	Get	Device Type	WORD	120 (20-COMM-C) 129 (20-COMM-Q)
3	Get	Product Code	WORD	Number identifying product name and rating
4	Get	Revision: Major Minor	STRUCT of: BYTE BYTE	Value varies Value varies
5	Get	Status	WORD	Bit 0 = Owned Bit 2 = Configured Bit 10 = Recoverable fault Bit 11 = Unrecoverable fault
6	Get	Serial Number	DWORD	Unique 32-bit number
7	Get	Product Name	SHORT_STRING	Product name and rating

## Assembly Object

### Class Code

Hexadecimal	Decimal
0x04	4

### Services

Service Code	Implemented for:		Service Name
	Class	Instance	
0x0E	Yes	Yes	Get_Attribute_Single
0x10	Yes	Yes	Set_Attribute_Single

### Instances

Instance	Description
1	All I/O data being read from the DPI device (read-only)
2	All I/O data being written to the DPI device (read/write)

### Class Attributes

Attribute ID	Access Rule	Name	Data Type	Description
1	Get	Revision	WORD	2
2	Get	Max Instance	WORD	2
100	Set	Control Timeout	WORD	Control timeout in seconds

### Instance Attributes

Attribute ID	Access Rule	Name	Data Type	Description
1	Get	Number of Members	WORD	1
2	Get	Member List	ARRAY of STRUCT: WORD WORD Packed EPATH	Size of member data Size of member path Member path
3	Conditional <sup>(1)</sup>	Data	Array of Bits	Data to be transferred
4	Get	Size	WORD	Size of assembly data in bits

<sup>(1)</sup> For instance 1, access rule for the data attribute is Get. For instance 2, access rule is Get/Set.

**Important:** Setting an assembly object attribute can be done only when the Control Timeout (class attribute 100) has been set to a non-zero value.

## Register Object

### Class Code

Hexadecimal	Decimal
0x07	7

### Services

Service Code	Implemented for:		Service Name
	Class	Instance	
0x0E	Yes	Yes	Get_Attribute_Single
0x10	Yes	Yes	Set_Attribute_Single

### Instances

Instance	Description
1	All I/O data being read from the DPI device (read-only)
2	All I/O data written to the DPI device (read/write)
3	Logic Status and Feedback data (read-only)
4	Logic Command and Reference data (read/write)
5	Datalink A (input data from device to scanner) (read only)
6	Datalink A (output data from scanner to device) (read/write)
7	Datalink B (input data from device to scanner) (read only)
8	Datalink B (output data from scanner to device) (read/write)
9	Datalink C (input data from device to scanner) (read only)
10	Datalink C (output data from scanner to device) (read/write)
11	Datalink D (input data from device to scanner) (read only)
12	Datalink D (output data from scanner to device) (read/write)
13	Logic Status and Feedback Data (read-only)
14	Mask <sup>(1)</sup> (read/write)
15	Logic Status (read-only)
16	Logic Command (read/write)
17	Feedback (read-only)
18	Reference (read/write)

<sup>(1)</sup> The mask command word is set to the value of the first word of the data where there are ones in the second word of the data. Command = (word 1 and not word 2) or (word 1 and word 2). This only controls specified bits in the Logic Command data to the DPI product and does not change the Reference value.

### Class Attributes

Attribute ID	Access Rule	Name	Data Type	Description
100	Set	Control Timeout	WORD	Control timeout in seconds

### Instance Attributes

Attribute ID	Access Rule	Name	Data Type	Description
1	Get	Bad Flag	BOOL	If set to 1, then attribute 4 may contain invalid data. 0 = good 1 = bad
2	Get	Direction	BOOL	Direction of data transfer 0 = Producer Register (drive to network) 1 = Consumer Register (network to drive)
3	Get	Size	WORD	Size of register data in bits
4	Conditional <sup>(1)</sup>	Data	ARRAY of BITS	Data to be transferred

<sup>(1)</sup> For this attribute, the Access Rule is Get if Direction = 0. The Access Rule is Set if Direction = 1.

**Important:** Setting a Register object attribute can only be done when the Control Timeout (class attribute 100) has been set to a non-zero value.

## Parameter Object

### Class Code

Hexadecimal	Decimal
0x0F	15

**Important:** This object is not supported when the adapter is used with a PowerFlex 750-Series drive.

### Services

Service Code	Implemented for:		Service Name
	Class	Instance	
0x01	Yes	Yes	Get_Attributes_All
0x05	Yes	No	Reset
0x0E	Yes	Yes	Get_Attribute_Single
0x10	No	Yes	Set_Attribute_Single
0x4B	No	Yes	Get_Enum_String

### Instances

The number of instances depends on the number of parameters in the DPI drive. The adapter parameters are appended to the list of drive parameters. The total number of parameters can be read in Instance 0, Attribute 2.

Instance	Description
0	Class Attributes
1	Drive Parameter 1 Attributes
:	:
n	Last Drive Parameter n Attributes <sup>(1)</sup>
n + 1	Adapter Parameter 1 Attributes
:	:
n + m	Last Adapter Parameter m Attributes <sup>(2)</sup>

<sup>(1)</sup> n represents the number of parameters in the drive.

<sup>(2)</sup> m represents the number of parameters in the adapter.

### Class Attributes

Attribute ID	Access Rule	Name	Data Type	Description
1	Get	Revision	WORD	1
2	Get	Max Instance	WORD	Number of parameters
8	Get	Parameter Class Descriptor	WORD	0 = False, 1 = True Bit 0 = Supports parameter instances Bit 1 = Supports full attributes Bit 2 = Must do NVS save command Bit 3 = Parameters are stored in NVS
9	Get	Configuration Assembly Instance	WORD	0
10	Set	Native Language	BYTE	0 = English 1 = French 2 = Spanish 3 = Italian 4 = German 5 = Japanese 6 = Portuguese 7 = Mandarin Chinese 8 = Russian 9 = Dutch

## Instance Attributes

Attribute ID	Access Rule	Name	Data Type	Description
1	(1)	Parameter Value	(2)	(3)
2	Get	Link Path Size	BYTE	0 = No link specified n = The size of Attribute 3 in bytes
3	Get	Link Path		(4)
4	Get	Descriptor	WORD	0 = False, 1 = True Bit 1 = Supports ENUMs Bit 2 = Supports scaling Bit 3 = Supports scaling links Bit 4 = Read only Bit 5 = Monitor Bit 6 = Extended precision scaling
5	Get	Data Type	BYTE	1 = WORD (16-bit) 2 = UINT (16-bit) 3 = INT (16-bit) 5 = SINT 6 = DINT 8 = USINT 9 = UDINT 11 = REAL 23 = SHORT_STRING 24 = BYTE 25 = DWORD
6	Get	Data Size	BYTE	(3)
7	Get	Parameter Name String	SHORT_STRING	(3)
8	Get	Units String	SHORT_STRING	(3)
9	Get	Help String	SHORT_STRING	Null string
10	Get	Minimum Value	(2)	(3)
11	Get	Maximum Value	(2)	(3)
12	Get	Default Value	(2)	(3)
13	Get	Scaling Multiplier	WORD	(3)
14	Get	Scaling Divisor	WORD	(3)
15	Get	Scaling Base	WORD	(3)
16	Get	Scaling Offset	WORD	(3)
17	Get	Multiplier Link	WORD	(3)
18	Get	Divisor Link	WORD	(3)
19	Get	Base Link	WORD	(3)
20	Get	Offset Link	WORD	(3)
21	Get	Decimal Precision	BYTE	(3)

(1) Access rule is defined in Bit 4 of instance attribute 4 (0 = Get/Set, 1 = Get).

(2) Specified in descriptor, data type, and data size.

(3) Value varies based on parameter instance.

(4) See the ControlNet specification for a description of the link path.



## Parameter Group Object

### Class Code

Hexadecimal	Decimal
0x10	16

**Important:** This object is not supported when the adapter is used with a PowerFlex 750-Series drive.

### Services

Service Code	Implemented for:		Service Name
	Class	Instance	
0x01	Yes	Yes	Get_Attributes_All
0x0E	Yes	Yes	Get_Attribute_Single
0x10	Yes	No	Set_Attribute_Single

### Instances

The number of instances depends on the number of groups in the device. A group of adapter parameters is appended to the list of groups in the device. The total number of groups can be read in Instance 0, Attribute 2.

Number	Description
0	Class Attributes
1	Drive Group 1 Attributes
⋮	⋮
n	Last Drive Group Attributes
n + 1	Adapter Group Attributes

### Class Attributes

Attribute ID	Access Rule	Name	Data Type	Description
1	Get	Parameter Group Version	WORD	1
2	Get	Max Instance	WORD	Total number of groups
8	Set	Native Language	BYTE	0 = English 1 = French 2 = Spanish 3 = Italian 4 = German 5 = Japanese 6 = Portuguese 7 = Mandarin Chinese 8 = Russian 9 = Dutch

### Instance Attributes

Attribute ID	Access Rule	Name	Data Type	Description
1	Get	Group Name String	SHORT_STRING	Group name
2	Get	Number of Members in Group	WORD	Number of parameters in group
3	Get	1st Parameter Number in Group	WORD	(1)
4	Get	2nd Parameter Number in Group	WORD	(1)
n	Get	⋮	WORD	(1)

(1) Value varies based on group instance.

## PCCC Object

### Class Code

Hexadecimal	Decimal
0x67	103

### Services

Service Code	Implemented for:		Service Name
	Class	Instance	
0x4B	No	Yes	Execute_PCCC
0x4C	No	Yes	Execute_DH+

### Instances

Not supported.

### Class Attributes

Not supported.

### Instance Attributes

Not supported.

### Message Structure for Execute\_PCCC

Request		
Name	Data Type	Description
Length	USINT	Length of requestor ID
Vendor	UINT	Vendor number of requestor
Serial Number	UDINT	ASA serial number of requestor
Other	Product Specific	Identifier of user, task, etc. on the requestor
CMD	USINT	Command byte
STS	USINT	0
TNSW	UINT	Transport word
FNC	USINT	Function code; not used for all CMDs.
PCCC_params	ARRAY of USINT	CMD/FNC specific parameters

Response		
Name	Data Type	Description
Length	USINT	Length of requestor ID
Vendor	UINT	Vendor number of requestor
Serial Number	UDINT	ASA serial number of requestor
Other	Product Specific	Identifier of user, task, etc. on the requestor
CMD	USINT	Command byte
STS	USINT	Status byte
TNSW	UINT	Transport word. Same value as the request.
EXT_STS	USINT	Extended status; not used for all CMDs.
PCCC_results	ARRAY of USINT	CMD/FNC specific result data

### Message Structure for Execute\_DH+

Request		
Name	Data Type	Description
DLink	UINT	Destination Link ID
DSta	USINT	Destination Station number
DUser	USINT	Destination "User" number
SLink	UINT	Source Link ID
SSta	USINT	Source Station number
SUser	USINT	Source User number
CMD	USINT	Command byte
STS	USINT	0
TNSW	UINT	Transport word
FNC	USINT	Function code; not used for all CMDs
PCCC_ params	ARRAY of USINT	CMD/FNC specific parameters

Response		
Name	Data Type	Description
DLink	UINT	Destination Link ID
DSta	USINT	Destination Station number
DUser	USINT	Destination "User" number
SLink	UINT	Source Link ID
SSta	USINT	Source Station number
SUser	USINT	Source User number
CMD	USINT	Command byte
STS	USINT	Status byte
TNSW	UINT	Transport word. Same value as the request.
EXT_STS	USINT	Extended status; not used for all CMDs
PCCC_ results	ARRAY of USINT	CMD/FNC specific result data

The adapter supports the following PCCC command types:

CMD	FNC	Description
0x06	0x03	Identify host and some status
0F	67	PLC-5 typed write
0F	68	PLC-5 typed read
0F	95	Encapsulate other protocol
0F	A2	SLC 500 protected typed read with 3 address fields
0F	AA	SLC 500 protected typed write with 3 address fields
0F	A1	SLC 500 protected typed read with 2 address fields
0F	A9	SLC 500 protected typed write with 2 address fields
0F	00	Word range read
0F	01	Word range write

For more information regarding PCCC commands, see DF1 Protocol and Command Set Manual, publication 1770-6.5.16.

### N-Files

N-File	Description	
N41	<p>This N-file lets you read and write control I/O messages. You can write control I/O messages only when all of the following conditions are true:</p> <ul style="list-style-type: none"> <li>• The adapter is not receiving I/O from a scanner. For example, there is no scanner on the network, the scanner is in idle (program) mode, the scanner is faulted, or the adapter is not mapped to the scanner.</li> <li>• The adapter is not receiving peer I/O from another adapter.</li> <li>• The value of N42:3 is set to a non-zero value.</li> </ul>	
	<i>Write</i>	<i>Read</i>
N41:0	Logic Command Word	Logic Status Word
N41:1	Reference (least significant word)	Feedback (least significant word)
N41:2	Reference (most significant word)	Feedback (most significant word)
N41:3	Datalink A1 (least significant word)	Datalink A1 (least significant word)
N41:4	Datalink A1 (most significant word)	Datalink A1 (most significant word)
N41:5	Datalink A2 (least significant word)	Datalink A2 (least significant word)
N41:6	Datalink A2 (most significant word)	Datalink A2 (most significant word)
N41:7	Datalink B1 (least significant word)	Datalink B1 (least significant word)
N41:8	Datalink B1 (most significant word)	Datalink B1 (most significant word)
N41:9	Datalink B2 (least significant word)	Datalink B2 (least significant word)
N41:10	Datalink B2 (most significant word)	Datalink B2 (most significant word)
N41:11	Datalink C1 (least significant word)	Datalink C1 (least significant word)
N41:12	Datalink C1 (most significant word)	Datalink C1 (most significant word)
N41:13	Datalink C2 (least significant word)	Datalink C2 (least significant word)
N41:14	Datalink C2 (most significant word)	Datalink C2 (most significant word)
N41:15	Datalink D1 (least significant word)	Datalink D1 (least significant word)
N41:16	Datalink D1 (most significant word)	Datalink D1 (most significant word)
N41:17	Datalink D2 (least significant word)	Datalink D2 (least significant word)
N41:18	Datalink D2 (most significant word)	Datalink D2 (most significant word)
N42	This N-file lets you read and write some values configuring the port.	
N42:3	Time-out (read/write): Time (in seconds) allowed between messages to the N41 file. If the adapter does not receive a message in the specified time, it performs the fault action configured in its [Comm Flt Action] parameter. A valid setting is between 1 and 32767 seconds (5...20 seconds is recommended).	
N42:7	Adapter Port Number (read only): DPI port on the drive to which the adapter is connected.	
N42:8	Peer Adapters (read only): Bit field of devices having DPI Peer capabilities.	

N45	This N-file lets you read and write control I/O messages. You can write control I/O messages only when all of the following conditions are true:	
	<ul style="list-style-type: none"> <li>• The adapter is not receiving I/O from a scanner. For example, there is no scanner on the network, the scanner is in idle (program) mode, the scanner is faulted, or the adapter is not mapped to the scanner.</li> <li>• The adapter is not receiving peer I/O from another adapter.</li> <li>• The value of N42:3 is set to a non-zero value.</li> </ul>	
	<i>Write</i>	<i>Read</i>
N45:0	Logic Command (least significant)	Logic Status (least significant)
N45:1	Logic Command (most significant)	Logic Status (most significant)
N45:2	Reference (least significant)	Feedback (least significant)
N45:3	Reference (most significant)	Feedback (most significant)
N45:4	DL From Net 01 (least significant)	DL To Net 01 (least significant)
N45:5	DL From Net 01 (most significant)	DL To Net 01 (most significant)
N45:6	DL From Net 02 (least significant)	DL To Net 02 (least significant)
N45:7	DL From Net 02 (most significant)	DL To Net 02 (most significant)
N45:8	DL From Net 03 (least significant)	DL To Net 03 (least significant)
N45:9	DL From Net 03 (most significant)	DL To Net 03 (most significant)
N45:10	DL From Net 04 (least significant)	DL To Net 04 (least significant)
N45:11	DL From Net 04 (most significant)	DL To Net 04 (most significant)
N45:12	DL From Net 05 (least significant)	DL To Net 05 (least significant)
N45:13	DL From Net 05 (most significant)	DL To Net 05 (most significant)
N45:14	DL From Net 06 (least significant)	DL To Net 06 (least significant)
N45:15	DL From Net 06 (most significant)	DL To Net 06 (most significant)
N45:16	DL From Net 07 (least significant)	DL To Net 07 (least significant)
N45:17	DL From Net 07 (most significant)	DL To Net 07 (most significant)
N45:18	DL From Net 08 (least significant)	DL To Net 08 (least significant)
N45:19	DL From Net 08 (most significant)	DL To Net 08 (most significant)
N45:20	DL From Net 09 (least significant)	DL To Net 09 (least significant)
N45:21	DL From Net 09 (most significant)	DL To Net 09 (most significant)
N45:22	DL From Net 10 (least significant)	DL To Net 10 (least significant)
N45:23	DL From Net 10 (most significant)	DL To Net 10 (most significant)
N45:24	DL From Net 11 (least significant)	DL To Net 11 (least significant)
N45:25	DL From Net 11 (most significant)	DL To Net 11 (most significant)
N45:26	DL From Net 12 (least significant)	DL To Net 12 (least significant)
N45:27	DL From Net 12 (most significant)	DL To Net 12 (most significant)
N45:28	DL From Net 13 (least significant)	DL To Net 13 (least significant)
N45:29	DL From Net 13 (most significant)	DL To Net 13 (most significant)
N45:30	DL From Net 14 (least significant)	DL To Net 14 (least significant)
N45:31	DL From Net 14 (most significant)	DL To Net 14 (most significant)
N45:32	DL From Net 15 (least significant)	DL To Net 15 (least significant)
N45:33	DL From Net 15 (most significant)	DL To Net 15 (most significant)
N45:34	DL From Net 16 (least significant)	DL To Net 16 (least significant)
N45:35	DL From Net 16 (most significant)	DL To Net 16 (most significant)

**Important:** If your controller or HMI platform supports CIP messaging, use the CIP Parameter object to get and set parameters.

N-File	Description
N150...N199	These N-files let you read and write parameter values in DPI Port 0 (the host PowerFlex drive) as 32-bit double words. You can interpret the data in various ways (for example, 32-bit real, 32-bit integer) To read a parameter, you need to send a message with two elements. For example, to read parameter 1, read two elements beginning at N150:2. As another example, to read parameters 2...6, read ten elements beginning at N150:4.
N150:0...1	Number of parameters in the drive
N150:2...249	Drive parameters 1...124
N151:0...249	Drive parameters 125...249
N152:0...249	Drive parameters 250...374
N153:0...249	Drive parameters 375...499
⋮	⋮
N199:0...249	Drive parameters 6125...6249

N-File	Description
N201...N212	These N-files let you read and write values to DPI and Host parameters in Ports 1...14 (for example, a HIM or adapter) as 32-bit double words. You can interpret the data in various ways (for example, 32-bit real, 32-bit integer) To read a parameter, you need to send a message with two elements. For example, to read parameter 1 in the peripheral connected to DPI port 1, read two elements beginning at N201:2. As another example, to read parameters 2...6 in the peripheral connected to DPI port 5 (the adapter), read ten elements beginning at N209:4.
N201:0...1	Number of parameters in the DPI peripheral at DPI port 1
N201:2...249	Parameters 1...124 in the DPI peripheral at DPI port 1
N202:0...249	Parameters 125...249 in the DPI peripheral at DPI port 1
N203:0...1	Number of parameters in the DPI peripheral at DPI port 2
N203:2...249	Parameters 1...124 in the DPI peripheral at DPI port 2
N204:0...249	Parameters 125...249 in the DPI peripheral at DPI port 2
N205:0...1	Number of parameters in the DPI peripheral at DPI port 3
N205:2...249	Parameters 1...124 in the DPI peripheral at DPI port 3
N206:0...249	Parameters 125...249 in the DPI peripheral at DPI port 3
N207:0...1	Number of parameters in the DPI peripheral at DPI port 4
N207:2...249	Parameters 1...124 in the DPI peripheral at DPI port 4
N208:0...249	Parameters 125...249 in the DPI peripheral at DPI port 4
N209:0...1	Number of parameters in the DPI peripheral at DPI port 5
N209:2...249	Parameters 1...124 in the DPI peripheral at DPI port 5
N210:0...249	Parameters 125...249 in the DPI peripheral at DPI port 5
N211:0...1	Number of parameters in the DPI peripheral at DPI port 6
N211:2...249	Parameters 1...124 in the DPI peripheral at DPI port 6
N212:0...249	Parameters 125...249 in the DPI peripheral at DPI port 6
The following N-Files are supported only when the adapter is used with a PowerFlex 750-Series drive.	
N213:0...1	Number of parameters in the DPI peripheral at DPI port 7
N213:2...249	Parameters 1...124 in the DPI peripheral at DPI port 7
N214:0...249	Parameters 125...249 in the DPI peripheral at DPI port 7
N215:0...1	Number of parameters in the DPI peripheral at DPI port 8
N215:2...249	Parameters 1...124 in the DPI peripheral at DPI port 8
N216:0...249	Parameters 125...249 in the DPI peripheral at DPI port 8
N217:0...1	Number of parameters in the DPI peripheral at DPI port 9
N217:2...249	Parameters 1...124 in the DPI peripheral at DPI port 9
N218:0...249	Parameters 125...249 in the DPI peripheral at DPI port 9
N219:0...1	Number of parameters in the DPI peripheral at DPI port 10
N219:2...249	Parameters 1...124 in the DPI peripheral at DPI port 10
N220:0...249	Parameters 125...249 in the DPI peripheral at DPI port 10
N221:0...1	Number of parameters in the DPI peripheral at DPI port 11
N221:2...249	Parameters 1...124 in the DPI peripheral at DPI port 11
N222:0...249	Parameters 125...249 in the DPI peripheral at DPI port 11
N223:0...1	Number of parameters in the DPI peripheral at DPI port 12
N223:2...249	Parameters 1...124 in the DPI peripheral at DPI port 12
N224:0...249	Parameters 125...249 in the DPI peripheral at DPI port 12
N225:0...1	Number of parameters in the DPI peripheral at DPI port 13
N225:2...249	Parameters 1...124 in the DPI peripheral at DPI port 13
N226:0...249	Parameters 125...249 in the DPI peripheral at DPI port 13
N227:0...1	Number of parameters in the DPI peripheral at DPI port 14
N227:2...249	Parameters 1...124 in the DPI peripheral at DPI port 14
N228:0...249	Parameters 125...249 in the DPI peripheral at DPI port 14

## DPI Device Object

### Class Code

Hexadecimal	Decimal
0x92	146

### Services

Service Code	Implemented for:		Service Name
	Class	Instance	
0x0E	Yes	Yes	Get_Attribute_Single
0x10	Yes	Yes	Set_Attribute_Single

### Instances

The number of instances depends on the number of components in the device. The total number of components can be read in Instance 0, Class Attribute 4.

Instances (Hex.)	(Dec.)	Device	Example	Description
0x0000...0x3FFF	0...16383	Host	0	Class Attributes (Drive)
0x4000...0x43FF	16384...17407	Adapter	1	Drive Component 1
0x4400...0x47FF	17408...18431	DPI Port 1	2	Drive Component 2
0x4800...0x4BFF	18432...19455	DPI Port 2	:	:
0x4C00...0x4FFF	19456...20479	DPI Port 3	16384	Class Attributes (Adapter)
0x5000...0x53FF	20480...21503	DPI Port 4	16385	Adapter Component 1
0x5400...0x57FF	21504...22527	DPI Port 5	:	:
0x5800...0x5BFF	22528...23551	DPI Port 6		
0x5C00...0x5FFF <sup>(1)</sup>	22552...24575	DPI Port 7		
0x6000...0x63FF <sup>(1)</sup>	24576...25599	DPI Port 8		
0x6400...0x67FF <sup>(1)</sup>	25600...26623	DPI Port 9		
0x6800...0x6BFF <sup>(1)</sup>	26624...27647	DPI Port 10		
0x6C00...0x6FFF <sup>(1)</sup>	27648...28671	DPI Port 11		
0x7000...0x73FF <sup>(1)</sup>	28672...29695	DPI Port 12		
0x7400...0x77FF <sup>(1)</sup>	29696...30719	DPI Port 13		
0x7800...0x7BFF <sup>(1)</sup>	30720...31743	DPI Port 14		

<sup>(1)</sup> These instances are supported only when the adapter is used with a PowerFlex 750-Series drive.

### Class Attributes

Attribute ID	Access Rule	Name	Data Type	Description
0	Get	Family Code	BYTE	0x00 = Communications Adapter 0x30 = PowerFlex 70 0x34 = PowerFlex 700H 0x38, 0x39, or 0x3A = PowerFlex 700 0x40 = PowerFlex 7000 0x48, 0x49, or 0x4A = PowerFlex 700S 0x5A = SMC Flex 0x68, 0x69, or 0x6A = PowerFlex 700VC 0x90 = PowerFlex 753/755 0xA0 = 20-750-xxx Option Module 0xFF = HIM
1	Get	Family Text	STRING[16]	Text identifying the device.

Attribute ID	Access Rule	Name	Data Type	Description
2	Set	Language Code	BYTE	0 = English 1 = French 2 = Spanish 3 = Italian 4 = German 5 = Japanese 6 = Portuguese 7 = Mandarin Chinese 8 = Russian 9 = Dutch
3	Get	Product Series	BYTE	1 = A 2 = B ...
4	Get	Number of Components	BYTE	Number of components (for example, main control board, I/O boards, and so forth) in the device.
5	Set	User Definable Text	STRING[16]	Text identifying the device with a user-supplied name.
6	Get	Status Text	STRING[12]	Text describing the status of the device.
7	Get	Configuration Code	BYTE	Identification of variations.
8	Get	Configuration Text	STRING[16]	Text identifying a variation of a family device.
9	Get	Brand Code	WORD	0x0001 = Allen-Bradley
11	Get	NVS Checksum	WORD	Checksum of the Nonvolatile Storage in a device.
12	Get	Class Revision	WORD	2 = DPI
13	Get	Character Set Code	BYTE	0 = SCANport HIM 1 = ISO 8859-1 (Latin 1) 2 = ISO 8859-2 (Latin 2) 3 = ISO 8859-3 (Latin 3) 4 = ISO 8859-4 (Latin 4) 5 = ISO 8859-5 (Cyrillic) 6 = ISO 8859-6 (Arabic) 7 = ISO 8859-7 (Greek) 8 = ISO 8859-8 (Hebrew) 9 = ISO 8859-9 (Turkish) 10 = ISO 8859-10 (Nordic) 255 = ISO 10646 (Unicode)
15	Get	Languages Supported	STRUCT of: BYTE BYTE[n]	Number of Languages Language Codes (see Class Attribute 2)
16	Get	Date of Manufacture	STRUCT of: WORD BYTE BYTE	Year Month Day
17	Get	Product Revision	STRUCT of: BYTE BYTE	Major Firmware Release Minor Firmware Release
18	Get	Serial Number	DWORD	Value between 0x00 and 0xFFFFFFFF
19	Set	Language Selected	BYTE	0 = Default (HIM will prompt at start up) 1 = Language was selected (no prompt)
20	Set	Customer-Generated Firmware	STRING[36]	GUID (Globally Unique Identifier) identifying customer firmware flashed into the device.
30	Get	International Status Text	STRINGN	Text describing the status of device with support for Unicode.
31	Get/Set	International User Definable Text	STRINGN	Text identifying the device with a user-supplied name with support for Unicode.



Attribute ID	Access Rule	Name	Data Type	Description
34	Get	Key Information	STRUCT of: DWORD DWORD WORD WORD WORD WORD BYTE BYTE BYTE BYTE BYTE BYTE BYTE[16]	Rating Code Device Serial Number Customization Code Customization Revision Brand Code Family Code Config Code Language Code Major Revision Minor Revision Customer-Generated Firmware UUID
35	Get	NVS CRC	DWORD	A 32-bit CRC of the Non-Volatile Storage in a device.
39	Get	SI Driver Code	WORD	Code identifying the protocol between the device and host.
128	Get	Customization Code	WORD	Code identifying the customized device.
129	Get	Customization Revision Number	WORD	Revision of the customized device.
130	Get	Customization Device Text	STRING[32]	Text identifying the customized device.

### Instance Attributes

Attribute ID	Access Rule	Name	Data Type	Description
3	Get	Component Name	STRING[32]	Name of the component
4	Get	Component Firmware Revision	STRUCT of: BYTE BYTE	Major Revision Minor Revision
5	Get	Component Hardware Change Number	BYTE	0 = Not available
8	Get	Component Serial Number	DWORD	Value between 0x00 and 0xFFFFFFFF
9	Get	International Component Name	STRINGN	Name of the component with support for Unicode.

## DPI Parameter Object

### Class Code

Hexadecimal	Decimal
0x93	147

To access 'Host Config' parameters, use the HOST DPI Parameter Object (Class code 0x9F).

### Instances

The number of instances depends on the number of parameters in the device. The total number of parameters can be read in Instance 0, Attribute 0.

Instances (Hex.)	(Dec.)	Device	Example	Description
0x0000...0x3FFF	0...16383	Host	0	Class Attributes (Drive)
0x4000...0x43FF	16384...17407	Adapter	1	Drive Parameter 1 Attributes
0x4400...0x47FF	17408...18431	DPI Port 1	2	Drive Parameter 2 Attributes
0x4800...0x4BFF	18432...19455	DPI Port 2	:	:
0x4C00...0x4FFF	19456...20479	DPI Port 3	16384	Class Attributes (Adapter)
0x5000...0x53FF	20480...21503	DPI Port 4	16385	Adapter Parameter 1 Attributes
0x5400...0x57FF	21504...22527	DPI Port 5	:	:
0x5800...0x5BFF	22528...23551	DPI Port 6		
0x5C00...0x5FFF <sup>(1)</sup>	23552...24575	DPI Port 7		
0x6000...0x63FF <sup>(1)</sup>	24576...25599	DPI Port 8		
0x6400...0x67FF <sup>(1)</sup>	25600...26623	DPI Port 9		
0x6800...0x6BFF <sup>(1)</sup>	26624...27647	DPI Port 10		
0x6C00...0x6FFF <sup>(1)</sup>	27648...28671	DPI Port 11		
0x7000...0x73FF <sup>(1)</sup>	28672...29695	DPI Port 12		
0x7400...0x77FF <sup>(1)</sup>	29696...30719	DPI Port 13		
0x7800...0x7BFF <sup>(1)</sup>	30720...31743	DPI Port 14		

<sup>(1)</sup> These instances are supported only when the adapter is used with a PowerFlex 750-Series drive.

### Class Attributes

Attribute ID	Access Rule	Name	Data Type	Description
0	Get	Number of Instances	WORD	Number of parameters in the device
1	Set	Write Protect Password	WORD	0 = Password disabled n = Password
2	Set	NVS Command Write	BYTE	0 = No Operation 1 = Store values in active memory to NVS 2 = Load values in NVS to active memory 3 = Load default values to active memory
3	Get	NVS Parameter Value Checksum	WORD	Checksum of all parameter values in a user set in NVS
4	Get	NVS Link Value Checksum	WORD	Checksum of parameter links in a user set in NVS
5	Get	First Accessible Parameter	WORD	First parameter available if parameters are protected by passwords. A '0' indicates all parameters are protected.
7	Get	Class Revision	WORD	2 = DPI
8	Get	First Parameter Processing Error	WORD	The first parameter that has been written with a value outside of its range. A '0' indicates no errors.
9	Set	Link Command	BYTE	0 = No Operation 1 = Clear All Parameter Links (This does not clear links to function blocks.)





## Descriptor Attributes

Bit	Name	Description
0	Data Type (Bit 1)	Right bit is least significant bit (0).
1	Data Type (Bit 2)	000 = BYTE used as an array of Boolean
2	Data Type (Bit 3)	001 = WORD used as an array of Boolean 010 = BYTE (8-bit integer) 011 = WORD (16-bit integer) 100 = DWORD (32-bit integer) 101 = TCHAR (8-bit (not unicode) or 16-bits (unicode)) 110 = REAL (32-bit floating point value) 111 = Use bits 16, 17, 18
3	Sign Type	0 = Unsigned 1 = Signed
4	Hidden	0 = Visible 1 = Hidden
5	Not a Link Sink	0 = Parameter can sink a link 1 = Parameter cannot sink a link
6	Not Recallable	0 = Recallable from NVS 1 = Not Recallable from NVS
7	ENUM	0 = No ENUM text 1 = ENUM text
8	Writable	0 = Read only 1 = Read/write
9	Not Writable When Enabled	0 = Writable when enabled (for example, drive running) 1 = Not writable when enabled
10	Instance	0 = Parameter value is not a Reference to another parameter 1 = Parameter value refers to another parameter
11	Uses Bit ENUM Mask	This parameter instance supports the Bit ENUM Mask attribute. For more information, see the definition of the attribute.
12	Decimal Place (Bit 0)	Number of digits to the right of the decimal point. 0000 = 0 1111 = 15
13	Decimal Place (Bit 1)	
14	Decimal Place (Bit 2)	
15	Decimal Place (Bit 3)	
16	Extended Data Type (Bit 1)	Right bit is least significant bit (16).
17	Extended Data Type (Bit 2)	000 = Reserved
18	Extended Data Type (Bit 3)	001 = DWORD used as an array of Boolean 010 = Reserved 011 = Reserved 100 = Reserved 101 = Reserved 110 = Reserved 111 = Reserved
19	Parameter Exists	Used to mark parameters that are not available to network tools.
20	Not Used	Reserved
21	Formula Links	Indicates the Formula Data is derived from other parameters.
22	Access Level (Bit 1)	A 3-bit field used to control access to parameter data.
23	Access Level (Bit 2)	
24	Access Level (Bit 3)	
25	Writable ENUM	ENUM text: 0 = Read Only, 1 = Read/Write
26	Not a Link Source	0 = Parameter can be a source for a link 1 = Parameter cannot be a source for a link
27	Enhanced Bit ENUM	Parameter supports enhanced bit ENUMs.
28	Enhanced ENUM	Parameter supports enhanced ENUMs.
29	Uses DPI Limits Object	Parameter uses the DPI Limits Object.
30	Extended Descriptor	Parameter uses Extended Descriptor bits, which can be obtained by reading the DPI Extended Descriptor attribute for this parameter.
31	Always Upload/Download	Parameter shall always be included in uploads and downloads.

## Extended Descriptor Attributes

Bit	Name	Description
0	Indirect Mode	0 = Analog (selects entire parameters) 1 = Digital (selects individual bits within parameters)
1	Indirect Type 0	Analog input list (Instance 0xFFFF)
2	Indirect Type 1	Digital input list (Instance 0xFFFE)
3	Indirect Type 2	Feedback list (Instance 0xFFFD)
4	Indirect Type 3	Analog output list (Instance 0xFFFC)
5	Indirect Type 4	Digital output list (Instance 0xFFFB)
6	Indirect Type 5	Undefined (Instance 0xFFFA)
7	Indirect Type 6	Undefined (Instance 0xFFF9)
8	Indirect Type 7	Undefined (Instance 0xFFF8)
9	Indirect Type 8	Undefined (Instance 0xFFF7)
10	Indirect Type 9	Undefined (Instance 0xFFF6)
11	Indirect Type 10	Undefined (Instance 0xFFF5)
12	Indirect Type 11	Undefined (Instance 0xFFF4)
13	Indirect Type 12	Undefined (Instance 0xFFF3)
14	Indirect Type 13	Undefined (Instance 0xFFF2)
15	Indirect Type 14	Parameter-specific list
16	FP Max Decimals Bit 0	These four bits are used on REAL parameters only. They indicate the maximum number of decimal places to be displayed for small values. A value of 0 indicates to not limit the number of decimal places used.
17	FP Max Decimals Bit 1	
18	FP Max Decimals Bit 2	
19	FP Max Decimals Bit 1	
20	Extended Parameter Reference	0 = Not an Extended Parameter Reference 1 = Extended Parameter Reference An Extended Parameter Reference contains a reference to another parameter. The value is formatted the same as an analog mode Indirect Selector parameter (SSpppp, where SS = slot number of device to which this Extended Parameter Reference is pointing, and pppp = number of the parameter or diagnostic item to which this Extended Parameter Reference is pointing). Note that an Extended Parameter Reference can only select parameters unlike an Indirect Selector. An Extended Parameter Reference could be used to configure a Datalink or show the source of a Reference (among other uses).
21	Uses Rating Table Object	This parameter has rating-dependent defaults and limits that can be obtained from the Rating Table Object. The Offline Read Full will include the default value for the smallest rating and limits that will accommodate the full range of values allowed in the family of devices using this particular combination of Family Code and Config Code. The Online Read Full will include the rating-dependent default and limit values for this particular combination of Family Code, Config Code, and Rating Code.
22	Writable Referenced Parameter	This bit must be zero unless the parameter is an Extended Parameter Reference. If the parameter is an Extended Parameter Reference, then: 0 = The referenced parameter may be read-only or writable. 1 = The referenced parameter must always be writable (including while running).
23	Disallow Zero	This bit must be zero unless the parameter is an Indirect Selector or Extended Parameter Reference. If the parameter is an Indirect Selector or Extended Parameter Reference, then: 0 = Allow zero 1 = Disallow zero If this bit is cleared (indicating that a value of zero is allowed), the device must support the 'Zero Text' parameter attribute so that a software tool or HIM can obtain text from the Zero Text parameter attribute. If this bit is set (indicating that a value of zero is disallowed), a software tool or HIM will not allow the user to enter a value of zero.
24	Datalink Out	This bit is used by offline tools and indicates that this is a Datalink Out parameter. Bit 20 must also be set.
25	Datalink In	This bit is used by offline tools and indicates that this is a Datalink In parameter. Bits 20 and 22 must also be set.
26	Not Writable While IO Active	This parameter cannot be written if the I/O data being exchanged between the Host and the peripheral is valid.

Bit	Name	Description
27	Command Parameter	This parameter commands the drive to take an action, such as 'Reset Defaults' or 'Autotune', and then returns to a value of zero. Offline software tools will not allow setting this parameter to anything other than a value of zero. If an offline file contains a Command Parameter with a non-zero value, the offline software tool will change the value to zero. Note that command parameters cannot have values that do not return to zero.
28	Current Value Is Default	This bit identifies a parameter that will not change if a 'Reset Defaults' is commanded. For example, if a drive contains a Language parameter that is set to German, setting defaults will leave the parameter set to German. Likewise, if the parameter is set to French, setting defaults will leave the parameter set to French.
29	Use Zero Text	If the 'Disallow Zero' bit is set, this bit must be cleared. If the 'Disallow Zero' bit is cleared, then: 0 = Use Disabled Text parameter class attribute. 1 = Use Zero Text parameter instance attribute.
30-31	Reserved	Reserved

## Formulas for Converting

Display Value = ((Internal Value + Offset) x Multiplier x Base) / (Divisor x 10<sup>Decimal Places</sup>)

Internal Value = ((Display Value x Divisor x 10<sup>Decimal Places</sup>) / (Multiplier x Base)) - Offset

## Common Services

Service Code	Implemented for:		Service Name
	Class	Instance	
0x0E	Yes	Yes	Get_Attribute_Single
0x10	Yes	Yes	Set_Attribute_Single

## Object-Specific Services

Service Code	Implemented for:		Service Name	Allocation Size (in bytes)	
	Class	Instance		Par. Number	Par. Value
0x4B	Yes	No	Get_Attributes_Scattered	2	2
0x4C	Yes	No	Set_Attributes_Scattered	2	2
0x4D <sup>(1)</sup>	Yes	No	Get_Attributes_Scattered	4	4
0x4E <sup>(1)</sup>	Yes	No	Set_Attributes_Scattered	4	4

<sup>(1)</sup> These services are supported only when the adapter is used with a PowerFlex 750-Series drive.

The table below lists the parameters for the Get\_Attributes\_Scattered and Set\_Attributes\_Scattered object-specific service.

Name	Data Type	Description
Parameter Number	UDINT	Parameter to read or write
Parameter Value	UDINT	Parameter value to read or write (zero when reading)

## DPI Fault Object

### Class Code

Hexadecimal	Decimal
0x97	151

Products such as PowerFlex drives use this object for faults. Adapters use this object for events.

### Services

Service Code	Implemented for:		Service Name
	Class	Instance	
0x0E	Yes	Yes	Get_Attribute_Single
0x10	Yes	Yes	Set_Attribute_Single

### Instances

The number of instances depends on the maximum number of faults or events supported in the queue. The maximum number of faults/events can be read in Instance 0, Attribute 2.

Instances (Hex.)	(Dec.)	Device	Example	Description
0x0000...0x3FFF	0...16383	Host	0	Class Attributes (Drive)
0x4000...0x43FF	16384...17407	Adapter	1	Most Recent Drive Fault
0x4400...0x47FF	17408...18431	DPI Port 1	2	Second Most Recent Drive Fault
0x4800...0x4BFF	18432...19455	DPI Port 2	:	:
0x4C00...0x4FFF	19456...20479	DPI Port 3	16384	Class Attributes (Adapter)
0x5000...0x53FF	20480...21503	DPI Port 4	16385	Most Recent Adapter Event
0x5400...0x57FF	21504...22527	DPI Port 5	:	:
0x5800...0x5BFF	22528...23551	DPI Port 6		
0x5C00...0x5FFF <sup>(1)</sup>	23552...24575	DPI Port 7		
0x6000...0x63FF <sup>(1)</sup>	24576...25599	DPI Port 8		
0x6400...0x67FF <sup>(1)</sup>	25600...26623	DPI Port 9		
0x6800...0x6BFF <sup>(1)</sup>	26624...27647	DPI Port 10		
0x6C00...0x6FFF <sup>(1)</sup>	27648...28671	DPI Port 11		
0x7000...0x73FF <sup>(1)</sup>	28672...29695	DPI Port 12		
0x7400...0x77FF <sup>(1)</sup>	29696...30719	DPI Port 13		
0x7800...0x7BFF <sup>(1)</sup>	30720...31743	DPI Port 14		

<sup>(1)</sup> These instances are supported only when the adapter is used with a PowerFlex 750-Series drive.

### Class Attributes

Attribute ID	Access Rule	Name	Data Type	Description
1	Get	Class Revision	WORD	Revision of object
2	Get	Number of Instances	WORD	Maximum number of faults/events that the device can record in its queue
3	Set	Fault Command Write	BYTE	0 = No Operation 1 = Clear Fault/Event 2 = Clear Fault/Event Queue 3 = Reset Device
4	Get	Fault Trip Instance Read	WORD	Fault that tripped the device. For adapters, this value is always 1 when faulted.



Attribute ID	Access Rule	Name	Data Type	Description
5	Get	Fault Data List	STRUCT of: BYTE BYTE WORD[n]	Number of faults/events in the queue. A '0' indicates the fault queue is empty.
6	Get	Number of Recorded Faults	WORD	Number of faults/events in the queue. A '0' indicates the fault queue is empty.
7	Get	Fault Parameter Reference	WORD	Number of faults/events in the queue. A '0' indicates the fault queue is empty.

### Instance Attributes

Attribute ID	Access Rule	Name	Data Type	Description
0	Get	Full/All Information	STRUCT of WORD STRUCT of: BYTE BYTE STRING[16] STRUCT of: LWORD BOOL[16]  WORD CONTAINER[n]	Fault code Fault source DPI port DPI Device Object Fault text Fault time stamp Timer value (0 = timer not supported) BOOL[0]: (0 = invalid data, 1 = valid data) BOOL[1]: (0 = elapsed time, 1 = real time) BOOL[2...15]: Not used Reserved Reserved
1	Get	Basic Information	STRUCT of: WORD STRUCT of: BYTE BYTE STRUCT of: LWORD BOOL[16]	Fault code Fault source DPI port DPI Device Object Fault time stamp Timer value (0 = timer not supported) BOOL[0]: (0 = invalid data, 1 = valid data) BOOL[1]: (0 = elapsed time, 1 = real time) BOOL[2...15]: Not used
2	Get	International Fault Text	STRINGN	Text describing the fault with support for Unicode.

## DPI Alarm Object

### Class Code

Hexadecimal	Decimal
0x98	152

Products such as PowerFlex drives use this object for alarms or warnings. Adapters do not support this object.

### Services

Service Code	Implemented for:		Service Name
	Class	Instance	
0x0E	Yes	Yes	Get_Attribute_Single
0x10	Yes	No	Set_Attribute_Single

### Instances

The number of instances depends on the maximum number of alarms supported by the queue. The maximum number of alarms can be read in Instance 0, Attribute 2.

Instances (Hex.)	(Dec.)	Device
0x0000...0x3FFF	0...16383	Host

Only host devices can have alarms.

Example	Description
0	Class Attributes (Drive)
1	Most Recent Alarm
2	Second Most Recent Alarm
:	:

### Class Attributes

Attribute ID	Access Rule	Name	Data Type	Description
1	Get	Class Revision	WORD	Revision of object
2	Get	Number of Instances	WORD	Maximum number of alarms that the device can record in its queue
3	Set	Alarm Command Write	BYTE	0 = No Operation 1 = Clear Alarm 2 = Clear Alarm Queue 3 = Reset Device
4	Get	Fault Data List	STRUCT of: BYTE BYTE WORD[n]	Reserved
5	Get	Number of Recorded Alarms	WORD	Number of alarms in the queue. A '0' indicates the alarm queue is empty.

## Instance Attributes

Attribute ID	Access Rule	Name	Data Type	Description
0	Get	Full/All Information	STRUCT of WORD STRUCT of: BYTE BYTE STRING[16] STRUCT of: LWORD BOOL[16]  WORD CONTAINER[n]	Alarm code Alarm source DPI port DPI Device Object Alarm text Alarm time stamp Timer value (0 = timer not supported) BOOL[0]: (0 = invalid data, 1 = valid data) BOOL[1]: (0 = elapsed time, 1 = real time) BOOL[2...15] Reserved Reserved Reserved
1	Get	Basic Information	STRUCT of WORD STRUCT of: BYTE BYTE STRUCT of: LWORD BOOL[16]	Alarm code Alarm source DPI port DPI Device Object Alarm time stamp Timer value (0 = timer not supported) BOOL[0]: (0 = invalid data, 1 = valid data) BOOL[1]: (0 = elapsed time, 1 = real time) BOOL[2...15] Reserved
2	Get	International Alarm Text	STRINGN	Text describing the alarm with support for Unicode.

**DPI Diagnostic Object****Class Code**

Hexadecimal	Decimal
0x99	153

**Services**

Service Code	Implemented for:		Service Name
	Class	Instance	
0x0E	Yes	Yes	Get_Attribute_Single
0x10	Yes	Yes	Set_Attribute_Single

**Instances**

The number of instances depends on the maximum number of diagnostic items in the device. The total number of diagnostic items can be read in Instance 0, Attribute 2.

Instances (Hex.)	(Dec.)	Device	Example	Description
0x0000...0x3FFF	0...16383	Host	0	Class Attributes (Drive)
0x4000...0x43FF	16384...17407	Adapter	1	Drive Diagnostic Item 1
0x4400...0x47FF	17408...18431	DPI Port 1	2	Drive Diagnostic Item 2
0x4800...0x4BFF	18432...19455	DPI Port 2	:	:
0x4C00...0x4FFF	19456...20479	DPI Port 3	16384	Class Attributes (Adapter)
0x5000...0x53FF	20480...21503	DPI Port 4	16385	Adapter Diagnostic Item 1
0x5400...0x57FF	21504...22527	DPI Port 5	:	:
0x5800...0x5BFF	22528...23551	DPI Port 6		
0x5C00...0x5FFF <sup>(1)</sup>	23552...24575	DPI Port 7		
0x6000...0x63FF <sup>(1)</sup>	24576...25599	DPI Port 8		
0x6400...0x67FF <sup>(1)</sup>	25600...26623	DPI Port 9		
0x6800...0x6BFF <sup>(1)</sup>	26624...27647	DPI Port 10		
0x6C00...0x6FFF <sup>(1)</sup>	27648...28671	DPI Port 11		
0x7000...0x73FF <sup>(1)</sup>	28672...29695	DPI Port 12		
0x7400...0x77FF <sup>(1)</sup>	29696...30719	DPI Port 13		
0x7800...0x7BFF <sup>(1)</sup>	30720...31743	DPI Port 14		

<sup>(1)</sup> These instances are supported only when the adapter is used with a PowerFlex 750-Series drive.

**Class Attributes**

Attribute ID	Access Rule	Name	Data Type	Description
1	Get	Class Revision	WORD	1
2	Get	Number of Instances	WORD	Number of diagnostic items in the device
3	Get	ENUM Offset	WORD	DPI ENUM object instance offset

## Instance Attributes

Attribute ID	Access Rule	Name	Data Type	Description
0	Get	Full/All Information	STRUCT of: BOOL[32] CONTAINER <sup>(1)</sup> CONTAINER CONTAINER CONTAINER WORD WORD STRING[4] UINT UINT UINT INT DWORD STRING[16]	Descriptor (see <a href="#">page C-19</a> ) Value Minimum value Maximum value Default value Pad Word Pad Word Units (for example, Amp, Hz) Multiplier <sup>(2)</sup> Divisor <sup>(2)</sup> Base <sup>(2)</sup> Offset <sup>(2)</sup> Link (source of the value) (0 = no link) Always zero (0) Parameter name
1	Get/Set	Value	Various	Diagnostic item value
2	Get	International Diagnostic Item Text	STRUCT of: STRINGN STRINGN	Diagnostic name text Diagnostic units text
3	Get	International Full Read All	STRUCT of: BOOL[32] CONTAINER CONTAINER CONTAINER CONTAINER WORD WORD WORD WORD WORD WORD INT DWORD BOOL[32] STRINGN STRINGN	Descriptor Value Minimum Maximum Default Pad Word Pad Word Multiplier Divisor Base Offset Pad Extended descriptor Diagnostic name text Diagnostic units text

<sup>(1)</sup> A CONTAINER is a 32-bit block of data that contains the data type used by a value. If signed, the value is sign extended. Padding is used in the CONTAINER to ensure that it is always 32-bits.

<sup>(2)</sup> This value is used in the formulas used to convert the value between display units and internal units. See [Formulas for Converting on page C-21](#).

## DPI Time Object

### Class Code

Hexadecimal	Decimal
0x9B	155

### Services

Service Code	Implemented for:		Service Name
	Class	Instance	
0x0E	Yes	Yes	Get_Attribute_Single
0x10	Yes	Yes	Set_Attribute_Single

### Instances

The number of instances depends on the number of timers in the device. Instance 1 is always reserved for a real-time clock although a device may not support it. The total number of timers can be read in Instance 0, Attribute 2.

Instances (Hex.)	(Dec.)	Device	Example	Description
0x0000...0x3FFF	0...16383	Host	0	Class Attributes (Drive)
0x4000...0x43FF	16384...17407	Adapter	1	Real Time Clock (Predefined) (not always supported)
0x4400...0x47FF	17408...18431	DPI Port 1	2	Timer 1
0x4800...0x4BFF	18432...19455	DPI Port 2	3	Timer 2
0x4C00...0x4FFF	19456...20479	DPI Port 3	⋮	⋮
0x5000...0x53FF	20480...21503	DPI Port 4		
0x5400...0x57FF	21504...22527	DPI Port 5		
0x5800...0x5BFF	22528...23551	DPI Port 6		
0x5C00...0x5FFF <sup>(1)</sup>	23552...24575	DPI Port 7		
0x6000...0x63FF <sup>(1)</sup>	24576...25599	DPI Port 8		
0x6400...0x67FF <sup>(1)</sup>	25600...26623	DPI Port 9		
0x6800...0x6BFF <sup>(1)</sup>	26624...27647	DPI Port 10		
0x6C00...0x6FFF <sup>(1)</sup>	27648...28671	DPI Port 11		
0x7000...0x73FF <sup>(1)</sup>	28672...29695	DPI Port 12		
0x7400...0x77FF <sup>(1)</sup>	29696...30719	DPI Port 13		
0x7800...0x7BFF <sup>(1)</sup>	30720...31743	DPI Port 14		

<sup>(1)</sup> These instances are supported only when the adapter is used with a PowerFlex 750-Series drive.

### Class Attributes

Attribute ID	Access Rule	Name	Data Type	Description
1	Get	Class Revision	WORD	Revision of object
2	Get	Number of Instances	WORD	Number of timers in the object, excluding the real-time clock that is predefined.
3	Get	First Device Specific Timer	WORD	Instance of the first timer that is not predefined.
4	Set	Time Command Write	BYTE	0 = No Operation 1 = Clear all timers (Does not clear the real-time clock or read only timers)
5	Get	Number of Supported Time Zones	WORD	Number of time zones described in the Time Zone List attribute.
6	Get	Time Zone List	STRUCT	Identifies a time zone.
7	Get/Set	Active Time Zone ID	WORD	The ID field of the Time Zone List structure for the desired time zone.

Attribute ID	Access Rule	Name	Data Type	Description
8	Get	Active Time Zone Data	STRUCT of: INT BYTE BYTE BYTE BYTE BYTE BYTE INT BYTE BYTE BYTE BYTE BYTE BYTE	Standard bias Standard month Standard day of week Standard week Standard hour Standard minute Standard second Daylight offset Daylight month Daylight day of week Daylight week Daylight hour Daylight minute Daylight second
9	Get/Set	Custom Time Zone Data	STRUCT of: INT BYTE BYTE BYTE BYTE BYTE BYTE INT BYTE BYTE BYTE BYTE BYTE BYTE BYTE	Standard bias Standard month Standard day of week Standard week Standard hour Standard minute Standard second Daylight offset Daylight month Daylight day of week Daylight week Daylight hour Daylight minute Daylight second

### Instance Attributes

Attribute ID	Access Rule	Name	Data Type	Description
0	Get	Read Full	STRUCT of: STRING[16] LWORD -or- STRUCT BOOL[16]	Name of the timer Elapsed time in milliseconds unless timer is a real-time clock (see attribute 2) See Attribute 3
1	Get	Timer Text	STRING[16]	Name of the timer
2	Get/Set	Timer Value	LWORD -or- STRUCT of: WORD BYTE BYTE BYTE BYTE BYTE BYTE	Elapsed time in milliseconds unless the timer is a real-time clock. Real-Time Clock Data: Milliseconds (0...999) Seconds (0...59) Minutes (0...59) Hours (0...23) Days (1...31) Months (1 = January, 12 = December) Years (since 1972)
3	Get	Timer Descriptor	BOOL[16]	BOOL[0]: (0 = invalid data, 1 = valid data) BOOL[1]: (0 = elapsed time, 1 = real time) BOOL[2...15]: Not used
4	Get	International Read Full	STRUCT of: STRINGN STRUCT BOOL[16]	International timer text Timer value Timer descriptor
5	Get	International Timer Text	STRINGN	Name of this timer
6	Get	Clock Status	BOOL[32]	Identifies clock status
8	Get/Set	Number of Leap Seconds	INT	Identifies the current number of Leap Seconds.
9	Get	Clock Options	BOOL[32]	Identifies the optional functionality available in the device's System Clock.
10	Get/Set	Clock Options Enable	BOOL[32]	Identifies which of the clock's options are enabled.

## Host DPI Parameter Object Class Code

Hexadecimal	Decimal
0x9F	159

To access 'Device' parameters, use the DPI Parameter Object (Class Code 0x93).

**Important:** The Host DPI Parameter Object is supported only when the adapter is used with a PowerFlex 750-Series drive.

### Instances

The number of instances depends on the number of parameters in the device. The total number of parameters can be read in Instance 0, Attribute 0.

Instances (Hex.)	(Dec.)	Device	Example	Description
0x0000...0x3FFF	0...16383	Reserved	16384	Class Attributes (Adapter)
0x4000...0x43FF	16384...17407	Adapter	16385	Adapter Parameter 1 Attributes
0x4400...0x47FF	17408...18431	DPI Port 1	16386	Adapter Parameter 2 Attributes
0x4800...0x4BFF	18432...19455	DPI Port 2	:	:
0x4C00...0x4FFF	19456...20479	DPI Port 3	17408	Class Attributes (HIM)
0x5000...0x53FF	20480...21503	DPI Port 4	17409	HIM Parameter 1 Attributes
0x5400...0x57FF	21504...22527	DPI Port 5	17410	HIM Parameter 2 Attributes
0x5800...0x5BFF	22528...23551	DPI Port 6	:	:
0x5C00...0x5FFF	23552...24575	DPI Port 7		
0x6000...0x63FF	24576...25599	DPI Port 8		
0x6400...0x67FF	25600...26623	DPI Port 9		
0x6800...0x6BFF	26624...27647	DPI Port 10		
0x6C00...0x6FFF	27648...28671	DPI Port 11		
0x7000...0x73FF	28672...29695	DPI Port 12		
0x7400...0x77FF	29696...30719	DPI Port 13		
0x7800...0x7BFF	30720...31743	DPI Port 14		

### Class Attributes

Attribute ID	Access Rule	Name	Data Type	Description
0	Get	Number of Instances	WORD	Number of parameters in the device
1	Set	Write Protect Password	WORD	0 = Password disabled n = Password
2	Set	NVS Command Write	BYTE	0 = No Operation 1 = Store values in active memory to NVS 2 = Load values in NVS to active memory 3 = Load default values to active memory
3	Get	NVS Parameter Value Checksum	WORD	Checksum of all parameter values in a user set in NVS
4	Get	NVS Link Value Checksum	WORD	Checksum of parameter links in a user set in NVS
5	Get	First Accessible Parameter	WORD	First parameter available if parameters are protected by passwords. A '0' indicates all parameters are protected.
7	Get	Class Revision	WORD	2 = DPI
8	Get	First Parameter Processing Error	WORD	The first parameter that has been written with a value outside of its range. A '0' indicates no errors.
9	Set	Link Command	BYTE	0 = No Operation 1 = Clear All Parameter Links (This does not clear links to function blocks.)







## Descriptor Attributes

Bit	Name	Description
0	Data Type (Bit 1)	Right bit is least significant bit (0).
1	Data Type (Bit 2)	000 = USINT used as an array of Boolean
2	Data Type (Bit 3)	001 = UINT used as an array of Boolean 010 = USINT (8-bit integer) 011 = UINT (16-bit integer) 100 = UDINT (32-bit integer) 101 = TCHAR ((8-bit (not Unicode) or 16-bits (Unicode)) 110 = REAL (32-bit floating point value) 111 = Use bits 16, 17, 18
3	Sign Type	0 = unsigned 1 = signed
4	Hidden	0 = visible 1 = hidden
5	Not a Link Sink	0 = May be the sink end of a link 1 = May not be the sink end of a link
6	Not Recallable	0 = Recallable from NVS 1 = Not Recallable from NVS
7	ENUM	0 = No ENUM text 1 = ENUM text
8	Writable	0 = Read only 1 = Read/write
9	Not Writable When Enabled	0 = Writable when enabled (for example, drive running) 1 = Not writable when enabled
10	Instance	0 = Parameter value is not a Reference to another parameter 1 = Parameter value refers to another parameter
11	Uses Bit ENUM Mask	This parameter instance supports the Bit ENUM Mask attribute. For more information, see the definition of the attribute.
12	Decimal Place (Bit 0)	Number of digits to the right of the decimal point. 0000 = 0 1111 = 15
13	Decimal Place (Bit 1)	
14	Decimal Place (Bit 2)	
15	Decimal Place (Bit 3)	
16	Extended Data Type (Bit 4)	Bit 16 is the least significant bit.
17	Extended Data Type (Bit 5)	000 = Reserved
18	Extended Data Type (Bit 6)	001 = UDINT used as an array of Boolean 010 = Reserved 011 = Reserved 100 = Reserved 101 = Reserved 110 = Reserved 111 = Reserved
19	Parameter Exists	Used to mark parameters that are not available to network tools.
20	Not Used	Reserved
21	Formula Links	Indicates the Formula Data is derived from other parameters.
22	Access Level (Bit 1)	A 3-bit field used to control access to parameter data.
23	Access Level (Bit 2)	
24	Access Level (Bit 3)	
25	Writable ENUM	ENUM text: 0 = Read Only, 1 = Read/Write
26	Not a Link Source	0 = May be the source end of a link 1 = May not be the source end of a link
27	Enhanced Bit ENUM	Parameter supports enhanced bit ENUMs.
28	Enhanced ENUM	Parameter supports enhanced ENUMs.
29	Uses DPI Limits Object	Parameter uses the DPI Limits Object. Intelligent offline tools make use of the Limits Object to select limits and units.
30	Extended Descriptor	Parameter uses Extended Descriptor bits, which can be obtained by reading the DPI Extended Descriptor attribute for this parameter.
31	Always Upload/Download	Parameter shall always be included in uploads and downloads.

## Extended Descriptor Attributes

Bit	Name	Description
0	Indirect Mode	0 = Analog (selects entire parameters) 1 = Digital (selects individual bits within parameters)
1	Indirect Type 0	Analog input list (Instance 0xFFFF)
2	Indirect Type 1	Digital input list (Instance 0xFFFE)
3	Indirect Type 2	Feedback list (Instance 0xFFFD)
4	Indirect Type 3	Analog output list (Instance 0xFFFC)
5	Indirect Type 4	Digital output list (Instance 0xFFFB)
6	Indirect Type 5	Undefined (Instance 0xFFFA)
7	Indirect Type 6	Undefined (Instance 0xFFF9)
8	Indirect Type 7	Undefined (Instance 0xFFF8)
9	Indirect Type 8	Undefined (Instance 0xFFF7)
10	Indirect Type 9	Undefined (Instance 0xFFF6)
11	Indirect Type 10	Undefined (Instance 0xFFF5)
12	Indirect Type 11	Undefined (Instance 0xFFF4)
13	Indirect Type 12	Undefined (Instance 0xFFF3)
14	Indirect Type 13	Undefined (Instance 0xFFF2)
15	Indirect Type 14	Parameter-specific list
16	FP Max Decimals Bit 0	These four bits are used on REAL parameters only. They indicate the maximum number of decimal places to be displayed for small values. A value of 0 indicates to not limit the number of decimal places used.
17	FP Max Decimals Bit 1	
18	FP Max Decimals Bit 2	
19	FP Max Decimals Bit 1	
20	Extended Parameter Reference	0 = Not an Extended Parameter Reference 1 = Extended Parameter Reference An Extended Parameter Reference contains a reference to another parameter. The value is formatted the same as an analog mode Indirect Selector parameter (SSpppp, where SS = slot number of device to which this Extended Parameter Reference is pointing, and pppp = number of the parameter or diagnostic item to which this Extended Parameter Reference is pointing). Note that an Extended Parameter Reference can only select parameters unlike an Indirect Selector. An Extended Parameter Reference could be used to configure a Datalink or show the source of a Reference (among other uses).
21	Uses Rating Table Object	This parameter has rating-dependent defaults and limits that can be obtained from the Rating Table Object. The Offline Read Full will include the default value for the smallest rating and limits that will accommodate the full range of values allowed in the family of devices using this particular combination of Family Code and Config Code. The Online Read Full will include the rating-dependent default and limit values for this particular combination of Family Code, Config Code, and Rating Code.
22	Writable Referenced Parameter	This bit must be zero unless the parameter is an Extended Parameter Reference. If the parameter is an Extended Parameter Reference, then: 0 = The referenced parameter may be read-only or writable. 1 = The referenced parameter must always be writable (including while running).
23	Disallow Zero	This bit must be zero unless the parameter is an Indirect Selector or Extended Parameter Reference. If the parameter is an Indirect Selector or Extended Parameter Reference, then: 0 = Allow zero 1 = Disallow zero If this bit is cleared (indicating that a value of zero is allowed), the device must support the 'Zero Text' parameter attribute so that a software tool or HIM can obtain text from the Zero Text parameter attribute. If this bit is set (indicating that a value of zero is disallowed), a software tool or HIM will not allow the user to enter a value of zero.
24	Datalink Out	This bit is used by offline tools and indicates that this is a Datalink Out parameter. Bit 20 must also be set.
25	Datalink In	This bit is used by offline tools and indicates that this is a Datalink In parameter. Bits 20 and 22 must also be set.
26	Not Writable While IO Active	This parameter cannot be written if the I/O data being exchanged between the Host and the peripheral is valid.

Bit	Name	Description
27	Command Parameter	This parameter commands the drive to take an action, such as 'Reset Defaults' or 'Autotune', and then returns to a value of zero. Offline software tools will not allow setting this parameter to anything other than a value of zero. If an offline file contains a Command Parameter with a non-zero value, the offline software tool will change the value to zero. Note that command parameters cannot have values that do not return to zero.
28	Current Value Is Default	This bit identifies a parameter that will not change if a 'Reset Defaults' is commanded. For example, if a drive contains a Language parameter that is set to German, setting defaults will leave the parameter set to German. Likewise, if the parameter is set to French, setting defaults will leave the parameter set to French.
29	Use Zero Text	If the 'Disallow Zero' bit is set, this bit must be cleared. If the 'Disallow Zero' bit is cleared, then: 0 = Use Disabled Text parameter class attribute. 1 = Use Zero Text parameter instance attribute.
30-31	Reserved	Reserved

## Formulas for Converting

$$\text{Display Value} = ((\text{Internal Value} + \text{Offset}) \times \text{Multiplier} \times \text{Base}) / (\text{Divisor} \times 10^{\text{Decimal Places}})$$

$$\text{Internal Value} = ((\text{Display Value} \times \text{Divisor} \times 10^{\text{Decimal Places}}) / (\text{Multiplier} \times \text{Base})) - \text{Offset}$$

## Common Services

Service Code	Implemented for:		Service Name
	Class	Instance	
0x0E	Yes	Yes	Get_Attribute_Single
0x10	Yes	Yes	Set_Attribute_Single

## Object Specific Services

Service Code	Implemented for:		Service Name	Allocation Size (in bytes)	
	Class	Instance		Par. Number	Par. Value
0x4D	Yes	No	Get_Attributes_Scattered	4	4
0x4E	Yes	No	Set_Attributes_Scattered	4	4

The table below lists the parameters for the Get\_Attributes\_Scattered and Set\_Attributes\_Scattered object-specific service.

Name	Data Type	Description
Parameter Number	UDINT	Parameter to read or write
Parameter Value	UDINT	Parameter value to read or write (zero when reading)

**Notes:**

## Logic Command/Status Words

This appendix presents the definitions of the Logic Command and Logic Status words that are used for some products that can be connected to the adapter. If the Logic Command/Logic Status for the product that you are using is not listed, refer to your product's documentation.

### PowerFlex 70/700/700H, and 700L (with 700 Control) Drives Logic Command Word

Logic Bits																Command	Description
15	14	13	12	11	10	9	8	7	6	5	4	3	2	1	0		
															x	Stop <sup>(1)</sup>	0 = Not Stop 1 = Stop
															x	Start <sup>(1)(2)</sup>	0 = Not Start 1 = Start
														x		Jog	0 = Not Jog (Par. 100) 1 = Jog
												x				Clear Faults	0 = Not Clear Faults 1 = Clear Faults
										x	x					Direction	00 = No Command 01 = Forward Command 10 = Reverse Command 11 = Hold Direction Control
									x							Local Control	0 = No Local Control 1 = Local Control
								x								MOP Increment	0 = Not Increment 1 = Increment
						x	x									Accel Rate	00 = No Command 01 = Accel Rate 1 Command (Par. 140) 10 = Accel Rate 2 Command (Par. 141) 11 = Hold Accel Rate
				x	x											Decel Rate	00 = No Command 01 = Decel Rate 1 Command (Par. 142) 10 = Decel Rate 2 Command (Par. 143) 11 = Hold Decel Rate
x	x	x														Reference Select <sup>(3)</sup>	000 = No Command 001 = Ref A Select (Par. 90) 010 = Ref B Select (Par. 93) 011 = Preset 3 (Par. 103) 100 = Preset 4 (Par. 104) 101 = Preset 5 (Par. 105) 110 = Preset 6 (Par. 106) 111 = Preset 7 (Par. 107)
x																MOP Decrement	0 = Not Decrement 1 = Decrement

<sup>(1)</sup> A '0 = Not Stop' condition (logic 0) must first be present before a '1 = Start' condition will start the drive. The Start command acts as a momentary Start command. A '1' will start the drive, but returning to '0' will not stop the drive.

<sup>(2)</sup> This Start will not function if a digital input (parameters 361...366) is programmed for 2-Wire Control (option 7, 8, or 9).

<sup>(3)</sup> This Reference Select will not function if a digital input (parameters 361...366) is programmed for 'Speed Sel 1, 2, or 3' (option 15, 16, or 17). Note that Reference Select is 'Exclusive Ownership' – see drive User Manual for more information.

### Logic Status Word

Logic Bits																Status	Description
15	14	13	12	11	10	9	8	7	6	5	4	3	2	1	0		
															x	Ready	0 = Not Ready (Par. 214) 1 = Ready
															x	Active	0 = Not Active (Running) 1 = Active
														x		Command Direction	0 = Reverse 1 = Forward
												x				Actual Direction	0 = Reverse 1 = Forward
											x					Accel	0 = Not Accelerating 1 = Accelerating
											x					Decel	0 = Not Decelerating 1 = Decelerating
												x				Alarm	0 = No Alarm (Par. 211 and 212) 1 = Alarm
													x			Fault	0 = No Fault (Par. 243) 1 = Fault
															x	At Speed	0 = Not At Reference 1 = At Reference
																Local Control <sup>(1)</sup>	000 = Port 0 (TB) 001 = Port 1 010 = Port 2 011 = Port 3 100 = Port 4 101 = Port 5 110 = Port 6 111 = No Local
x	x	x	x													Reference	0000 = Ref A Auto (Par. 90) 0001 = Ref B Auto (Par. 93) 0010 = Preset 2 Auto 0011 = Preset 3 Auto 0100 = Preset 4 Auto 0101 = Preset 5 Auto 0110 = Preset 6 Auto 0111 = Preset 7 Auto 1000 = Term Blk Manual 1001 = DPI 1 Manual 1010 = DPI 2 Manual 1011 = DPI 3 Manual 1100 = DPI 4 Manual 1101 = DPI 5 Manual 1110 = DPI 6 Manual 1111 = Jog Ref

<sup>(1)</sup> See 'Owners' in drive User Manual for further information.



**PowerFlex 700S (Phase II Control) and 700L (with 700S Control) Drives Logic Command Word**

Logic Bits																Command	Description																																								
15	14	13	12	11	10	9	8	7	6	5	4	3	2	1	0																																										
															x	Normal Stop	0 = Not Normal Stop 1 = Normal Stop																																								
															x	Start <sup>(1)</sup>	0 = Not Start 1 = Start																																								
														x		Jog 1	0 = Not Jog using [Jog Speed 1] (Par. 29) 1 = Jog using [Jog Speed 1] (Par. 29)																																								
												x				Clear Fault <sup>(2)</sup>	0 = Not Clear Fault 1 = Clear Fault																																								
										x	x					Unipolar Direction	00 = No Command 01 = Forward Command 10 = Reverse Command 11 = Hold Direction Control																																								
									x							Reserved																																									
								x								Jog 2	0 = Not Jog using [Jog Speed 2] (Par. 39) 1 = Jog using [Jog Speed 2] (Par. 39)																																								
							x									Current Limit Stop	0 = Not Current Limit Stop 1 = Current Limit Stop																																								
						x										Coast Stop	0 = Not Coast to Stop 1 = Coast to Stop																																								
				x												Reserved																																									
			x													Reserved																																									
		x														Spd Ref Sel0	<table border="1"> <thead> <tr> <th colspan="3">Bits</th> <th></th> </tr> <tr> <th>14</th> <th>13</th> <th>12</th> <th></th> </tr> </thead> <tbody> <tr> <td>0</td> <td>0</td> <td>0</td> <td>= Spd Ref A (Par. 27)</td> </tr> <tr> <td>0</td> <td>0</td> <td>1</td> <td>= Spd Ref B (Par. 28)</td> </tr> <tr> <td>0</td> <td>1</td> <td>0</td> <td>= Preset 2 (Par. 15)</td> </tr> <tr> <td>0</td> <td>1</td> <td>1</td> <td>= Preset 3 (Par. 16)</td> </tr> <tr> <td>1</td> <td>0</td> <td>0</td> <td>= Preset 4 (Par. 17)</td> </tr> <tr> <td>1</td> <td>0</td> <td>1</td> <td>= Preset 5 (Par. 18)</td> </tr> <tr> <td>1</td> <td>1</td> <td>0</td> <td>= Preset 6 (Par. 19)</td> </tr> <tr> <td>1</td> <td>1</td> <td>1</td> <td>= Preset 7 (Par. 20)</td> </tr> </tbody> </table>	Bits				14	13	12		0	0	0	= Spd Ref A (Par. 27)	0	0	1	= Spd Ref B (Par. 28)	0	1	0	= Preset 2 (Par. 15)	0	1	1	= Preset 3 (Par. 16)	1	0	0	= Preset 4 (Par. 17)	1	0	1	= Preset 5 (Par. 18)	1	1	0	= Preset 6 (Par. 19)	1	1	1	= Preset 7 (Par. 20)
Bits																																																									
14	13	12																																																							
0	0	0	= Spd Ref A (Par. 27)																																																						
0	0	1	= Spd Ref B (Par. 28)																																																						
0	1	0	= Preset 2 (Par. 15)																																																						
0	1	1	= Preset 3 (Par. 16)																																																						
1	0	0	= Preset 4 (Par. 17)																																																						
1	0	1	= Preset 5 (Par. 18)																																																						
1	1	0	= Preset 6 (Par. 19)																																																						
1	1	1	= Preset 7 (Par. 20)																																																						
	x															Spd Ref Sel1																																									
x																Spd Ref Sel2																																									
x																Reserved																																									

<sup>(1)</sup> A Not Stop condition (logic bit 0 = 0, logic bit 8 = 0, and logic bit 9 = 0) must first be present before a 1 = Start condition will start the drive.

<sup>(2)</sup> To perform this command, the value must switch from '0' to '1'.

### Logic Status Word

Logic Bits																Status	Description
15	14	13	12	11	10	9	8	7	6	5	4	3	2	1	0		
															x	Active	0 = Not Active 1 = Active
															x	Running	0 = Not Running 1 = Running
														x		Command Direction	0 = Reverse 1 = Forward
												x				Actual Direction	0 = Reverse 1 = Forward
											x					Accel	0 = Not Accelerating 1 = Accelerating
										x						Decel	0 = Not Decelerating 1 = Decelerating
									x							Jogging	0 = Not Jogging 1 = Jogging
								x								Fault	0 = No Fault (Par. 323, 324, 325) 1 = Fault
							x									Alarm	0 = No Alarm (Par. 326, 327, 328) 1 = Alarm
						x										Flash Mode	0 = Not in Flash Mode 1 = In Flash Mode
					x											Run Ready	0 = Not Ready to Run (Par. 156) 1 = Ready to Run
				x												At Limit <sup>(1)</sup>	0 = Not At Limit (Par. 304) 1 = At Limit
			x													Tach Loss Sw	0 = Not Tach Loss Sw 1 = Tach Loss Sw
		x														At Zero Spd	0 = Not At Zero Speed 1 = At Zero Speed
	x															At Setpt Spd	0 = Not At Setpoint Speed 1 = At Setpoint Speed
x																Enable	0 = Not Enabled 1 = Enabled

<sup>(1)</sup> See Parameter 304 - [Limit Status] in the PowerFlex 700S drive User Manual for a description of the limit status conditions.

**PowerFlex 750-Series Drives** **Important:** When using a 20-COMM-C or 20-COMM-Q adapter with a PowerFlex 750-Series drive, the upper word (bits 16...31) of the Logic Command and Logic Status words are not accessible and cannot be used. Only when using a PowerFlex 750-Series drive with a 20-750 communication Option Module, or the PowerFlex 755 drive's embedded EtherNet/IP adapter, is the upper word accessible and used.

### Logic Command Word

Logic Bits																Command	Description
31...15	14	13	12	11	10	9	8	7	6	5	4	3	2	1	0		
															x	Normal Stop	0 = Not Normal Stop 1 = Normal Stop
															x	Start <sup>(1)</sup>	0 = Not Start 1 = Start
														x		Jog 1 <sup>(2)</sup>	0 = Not Jog 1 (Par. 556) 1 = Jog 1
												x				Clear Fault <sup>(3)</sup>	0 = Not Clear Fault 1 = Clear Fault
										x	x					Unipolar Direction	00 = No Command 01 = Forward Command 10 = Reverse Command 11 = Hold Direction Control
									x							Manual	0 = Not Manual 1 = Manual
								x								Reserved	
						x	x									Accel Time	00 = No Command 01 = Use Accel Time 1 (Par. 535) 10 = Use Accel Time 2 (Par. 536) 11 = Use Present Time
				x	x											Decel Time	00 = No Command 01 = Use Decel Time 1 (Par. 537) 10 = Use Decel Time 2 (Par. 538) 11 = Use Present Time
			x													Ref Select 1	000 = No Command
		x														Ref Select 2	001 = Ref A Select (Par. 545) 010 = Ref B Select (Par. 550)
	x															Ref Select 3	011 = Preset 3 (Par. 573) 100 = Preset 4 (Par. 574) 101 = Preset 5 (Par. 575) 110 = Preset 6 (Par. 576) 111 = Preset 7 (Par. 577)
x																Reserved	

<sup>(1)</sup> A Not Stop condition (logic bit 0 = 0) must first be present before a 1 = Start condition will start the drive.

<sup>(2)</sup> A Not Stop condition (logic bit 0 = 0) must first be present before a 1 = Jog 1/Jog 2 condition will jog the drive. A transition to a '0' will stop the drive.

<sup>(3)</sup> To perform this command, the value must switch from '0' to '1'.

### Logic Status Word

Logic Bits																Command	Description
31...15	14	13	12	11	10	9	8	7	6	5	4	3	2	1	0		
															x	Run Ready	0 = Not Ready to Run (Par. 933) 1 = Ready to Run
															x	Active	0 = Not Active 1 = Active
														x		Command Direction	0 = Reverse 1 = Forward
												x				Actual Direction	0 = Reverse 1 = Forward
											x					Accelerating	0 = Not Accelerating 1 = Accelerating
										x						Decelerating	0 = Not Decelerating 1 = Decelerating
									x							Alarm	0 = No Alarm (Par. 959 and 960) 1 = Alarm
								x								Fault	0 = No Fault (Par. 952 and 953) 1 = Fault
							x									At Setpt Spd	0 = Not at Setpoint Speed 1 = At Setpoint Speed
						x										Manual	0 = Manual Mode Not Active 1 = Manual Mode Active
					x											Spd Ref ID 0	00000 = Reserved
				x												Spd Ref ID 1	00001 = Auto Ref A (Par. 545) 00010 = Auto Ref B (Par. 550)
			x													Spd Ref ID 2	00011 = Auto Preset Speed 3 (Par. 573)
		x														Spd Ref ID 3	00100 = Auto Preset Speed 4 (Par. 574)
	x															Spd Ref ID 4	00101 = Auto Preset Speed 5 (Par. 575) 00110 = Auto Preset Speed 6 (Par. 576) 00111 = Auto Preset Speed 7 (Par. 577) 01000 = Reserved 01001 = Reserved 01010 = Reserved 01011 = Reserved 01100 = Reserved 01101 = Reserved 01110 = Reserved 01111 = Reserved 10000 = Man Port 0 10001 = Man Port 1 10010 = Man Port 2 10011 = Man Port 3 10100 = Man Port 4 10101 = Man Port 5 10110 = Man Port 6 10111 = Reserved 11000 = Reserved 11001 = Reserved 11010 = Reserved 11011 = Reserved 11100 = Reserved 11101 = Man Port 13 (embedded ENET) 11110 = Man Port 14 (Drive Logix) 11111 = Alternate Man Ref Sel
x																Reserved	

## PowerFlex Digital DC Drives Logic Command Word

Logic Bits																Command	Description
15	14	13	12	11	10	9	8	7	6	5	4	3	2	1	0		
															x	Stop <sup>(1)</sup>	0 = Not Stop 1 = Stop
															x	Start <sup>(1)(2)</sup>	0 = Not Start 1 = Start
														x		Jog	0 = Not Jog (Par. 266) 1 = Jog
												x				Clear Faults	0 = Not Clear Faults 1 = Clear Faults
										x	x					Direction	00 = No Command 01 = Forward Command 10 = Reverse Command 11 = Hold Direction Control
										x						Local Control	0 = No Local Control 1 = Local Control
									x							MOP Increment	0 = Not Increment 1 = Increment
						x	x									Accel Rate	00 = No Command 01 = Use Accel Rate 1 (Par. 660) 10 = Use Accel Rate 2 (Par. 24) 11 = Use Present Time
				x	x											Decel Rate	00 = No Command 01 = Use Decel Rate 1 (Par. 662) 10 = Use Decel Rate 2 (Par. 32) 11 = Use Present Time
x	x	x														Reference Select <sup>(3)</sup>	000 = No Command 001 = Ref. 1 (Spd Ref A, Par. 44) 010 = Ref. 2 (Spd Ref B, Par. 48) 011 = Ref. 3 (Preset Spd 3, Par. 156) 100 = Ref. 4 (Preset Spd 4, Par. 157) 101 = Ref. 5 (Preset Spd 5, Par. 158) 110 = Ref. 6 (Preset Spd 6, Par. 159) 111 = Ref. 7 (Preset Spd 7, Par. 160)
x																MOP Decrement	0 = Not Decrement 1 = Decrement

<sup>(1)</sup> A '0 = Not Stop' condition (logic 0) must first be present before a '1 = Start' condition will start the drive. The Start command acts as a momentary Start command. A '1' will start the drive, but returning to '0' **will not** stop the drive.

<sup>(2)</sup> This Start will not function if a digital input (parameters 133...144) is programmed for 2-Wire Control (option 5 'Run', 6 'Run Forward', or 7 'Run Reverse').

<sup>(3)</sup> This Reference Select will not function if a digital input (parameters 133...144) is programmed for 'Speed Sel 1, 2, or 3' (option 17, 18, or 19). Note that Reference Select is 'Exclusive Ownership' – see drive User Manual for more information.

### Logic Status Word

Logic Bits																Status	Description
15	14	13	12	11	10	9	8	7	6	5	4	3	2	1	0		
															x	Ready	0 = Not Ready (Par. 1403) 1 = Ready
															x	Active	0 = Not Active (Running) 1 = Active
														x		Command Direction	0 = Reverse 1 = Forward
												x				Actual Direction	0 = Reverse 1 = Forward
											x					Accel	0 = Not Accelerating 1 = Accelerating
											x					Decel	0 = Not Decelerating 1 = Decelerating
											x					Alarm	0 = No Alarm (Par. 1380) 1 = Alarm
											x					Fault	0 = No Fault (Par. 1351) 1 = Fault
											x					At Speed	0 = Not At Reference 1 = At Reference
																Local Control <sup>(1)</sup>	000 = Port 0 (TB) 001 = Port 1 010 = Port 2 011 = Port 3 100 = Port 4 101 = Port 5 110 = Reserved 111 = No Local
x	x	x	x													Reference Source	0000 = Spd Ref A Auto (Par. 44) 0001 = Spd Ref B Auto (Par. 48) 0010 = Preset Spd 2 Auto 0011 = Preset Spd 3 Auto 0100 = Preset Spd 4 Auto 0101 = Preset Spd 5 Auto 0110 = Preset Spd 6 Auto 0111 = Preset Spd 7 Auto 1000 = Term Blk Manual 1001 = DPI 1 Manual 1010 = DPI 2 Manual 1011 = DPI 3 Manual 1100 = DPI 4 Manual 1101 = DPI 5 Manual 1110 = Reserved 1111 = Jog Ref

<sup>(1)</sup> See 'Owners' in drive User Manual for further information.

## **A Adapter**

Devices such as drives, controllers, and computers usually require a network communication adapter to provide a communication interface between them and a network such as ControlNet. An adapter reads data on the network and transmits it to the connected device. It also reads data in the device and transmits it to the network.

The 20-COMM-C (coax) or 20-COMM-Q (fiber) ControlNet adapter connects PowerFlex 7-Class drives to a ControlNet network. Adapters are sometimes also called ‘cards’, ‘embedded communication options’, ‘gateways’, ‘modules’, or ‘peripherals’.

## **B Bridge**

A network device that can route messages from one network to another. A bridge also refers to a communication module in a ControlLogix controller that connects the controller to a network. See also Scanner.

### **Bus Off**

A bus off condition occurs when an abnormal rate of errors is detected on the Control Area Network (CAN) bus in a device. The bus-off device cannot receive or transmit messages on the network. This condition is often caused by corruption of the network data signals due to noise or data rate mismatch.

## **C CAN (Controller Area Network)**

CAN is a serial bus protocol on which DPI is based.

### **CIP (Common Industrial Protocol)**

CIP is the transport and application layer protocol used for messaging over EtherNet/IP, ControlNet, and DeviceNet networks. The protocol is used for implicit messaging (real-time I/O) and explicit messaging (configuration, data collection, and diagnostics).

### **Connected Components Workbench Software**

The recommended tool for monitoring and configuring Allen-Bradley products and network communication adapters. It can be used on computers running various Microsoft operating systems. You can obtain a **free copy** of Connect Components Workbench software at <http://www.ab.com/support/abdrives/webupdate/software.html>.

### **ControlFLASH**

A **free** software tool used to electronically update firmware of Allen-Bradley products and network communication adapters. ControlFLASH software is downloaded automatically when the firmware revision file for the product being updated is downloaded from the Allen-Bradley updates website to your computer.

**Controller**

A controller, also called programmable logic controller, is a solid-state control system that has a user-programmable memory for storage of instructions to implement specific functions such as I/O control, logic, timing, counting, report generation, communication, arithmetic, and data file manipulation. A controller consists of a central processor, input/output interface, and memory. See also Scanner.

**ControlNet Network**

ControlNet is an open producer/consumer communication network with features, such as redundant media and deterministic I/O timing, designed for high-performance or time-critical requirements.

More information about ControlNet and the ControlNet specification is available online at <http://www.controlnet.org>.

**D Data Rate**

The speed at which data is transferred on the ControlNet network (fixed at 5 Mbps).

**Datalinks**

A Datalink is a type of pointer used by PowerFlex 7-Class drives to transfer data to and from the controller. Datalinks allow specified parameters to be read or written to without using explicit messages. When enabled, each Datalink consumes either four bytes or eight bytes in both the input and output image table of the controller. The drive determines the size of Datalinks.

**DPI (Drive Peripheral Interface)**

A second generation peripheral communication interface used by various Allen-Bradley drives and power products, such as PowerFlex 7-Class drives. It is a functional enhancement to SCANport.

**DPI Peripheral**

A device that provides an interface between DPI and a network or user. Peripheral devices are also referred to as 'adapters' or 'modules'. The 20-COMM-C or 20-COMM-Q adapter, 1203-USB or 1203-SSS converter, and PowerFlex 7-Class HIMs (catalog number 20-HIM-xxx) are examples of DPI peripherals.

**DPI Product**

A device that uses the DPI communication interface to communicate with one or more peripheral devices. For example, a motor drive such as a PowerFlex 7-Class drive is a DPI product. In this manual, a DPI product is also referred to as 'drive' or 'host'.



### **DriveExplorer Software**

A tool for monitoring and configuring Allen-Bradley products and network communication adapters. It can be used on computers running various Microsoft Windows operating systems. DriveExplorer software, version 3.xx or later, can be used to configure this adapter and PowerFlex drives. This software tool has been discontinued and is now available as **freeware** at <http://www.ab.com/support/abdrives/webupdate/software.html>. There are no plans to provide future updates to this tool and the download is being provided 'as-is' for users that lost their DriveExplorer CD, or need to configure legacy products not supported by Connected Components Workbench software.

### **DriveTools SP Software**

A software suite designed for running on various Microsoft Windows operating systems. This software suite provides a family of tools, including DriveExecutive software (version 3.01 or later), that you can use to program, monitor, control, troubleshoot, and maintain Allen-Bradley products. DriveTools SP software can be used with PowerFlex 7-Class and PowerFlex 4-Class drives, and legacy drives that implement the SCANport communication interface. Information about DriveTools SP software can be accessed at <http://www.ab.com/drives/drivetools>.

## **E EDS (Electronic Data Sheet) Files**

Simple text files that are used by network configuration tools such as RSNetWorx for ControlNet software to describe products so that you can easily commission them on a network. EDS files describe a product device type and revision. EDS files for many Allen-Bradley products can be found at <http://www.ab.com/networks/eds>.

### **Explicit Messaging**

Explicit Messages are used to transfer data that does not require continuous updates. They are typically used to configure, monitor, and diagnose devices over the network.

## **F Fault Action**

A fault action determines how the adapter and connected drive act when a communication fault (for example, a disconnected cable) occurs or when the controller is switched out of run mode. The former uses a communication fault action, and the latter uses an idle fault action.

### **Fault Configuration**

When communication is disrupted (for example, a cable is disconnected), the adapter and PowerFlex drive can respond with a user-defined fault configuration. The user sets the data that is sent to the drive using specific fault configuration parameters in the adapter. When a fault action parameter is set to use the fault configuration data and a fault occurs, the data from these parameters is sent as the Logic Command, Reference, and/or Datalinks.

## H HIM (Human Interface Module)

A device that can be used to configure and control a drive. PowerFlex 7-Class HIMs (catalog number 20-HIM-xx) can be used to configure PowerFlex 7-Class drives and their connected peripherals.

### Hold Last

When communication is disrupted (for example, a cable is disconnected), the adapter and PowerFlex drive can respond by holding last. Hold last results in the drive receiving the last data received via the network connection before the disruption. If the drive was running and using the Reference from the adapter, it will continue to run at the same Reference.

### Host Parameters (only PowerFlex 750-Series drives)

Host parameters are used to configure peripherals connected to a PowerFlex 750-Series drive. When using a PowerFlex 7-Class HIM (catalog number 20-HIM-A3/-A5/-C3S/-C5S), Host parameters **do not** appear. When using a PowerFlex 750-Series HIM (catalog number 20-HIM-A6/-C6S), Host parameters appear in the HOST PARAM folder. You can also view Host parameters with any of the following drive configuration tools:

- Connected Components Workbench software—click the tab for the option module at the bottom of the window, click the Parameters icon in the tool bar, and open the Host parameters folder.
- DriveExplorer software—find the option module in the treeview and open its Parameters folder.
- DriveExecutive software—find the option module in the treeview, expand the module in the tree, and open its Parameters folder.

## I Idle Action

An idle action determines how the adapter and connected drive act when the controller is switched out of run mode.

### I/O Data

I/O data, sometimes called ‘implicit messages’ or ‘input/output’, is time-critical data such as a Logic Command and Reference. The terms ‘input’ and ‘output’ are defined from the controller’s point of view. Output is produced by the controller and consumed by the adapter. Input is produced by the adapter and consumed by the controller.

## L Logic Command/Logic Status

The Logic Command is used to control the PowerFlex 7-Class drive (for example, start, stop, and direction). It consists of one 16-bit word of output to the adapter from the network. The definitions of the bits in this word depend on the drive, and are shown in [Appendix D](#).

The Logic Status is used to monitor the PowerFlex 7-Class drive (for example, operating state and motor direction). It consists of one 16-bit word of input from the adapter to the network. The definitions of the bits in this word depend on the drive, and are shown in [Appendix D](#).

### **M Master-Slave Hierarchy**

An adapter configured for a master-slave hierarchy exchanges data with the master device. Usually, a network has one scanner which is the master device, and all other devices (for example, drives connected to ControlNet adapters) are slave devices.

On a network with multiple scanners (called a multimaster hierarchy), each slave device must have a scanner specified as a master.

### **N Node Address**

A unique address that identifies each node on a ControlNet network. The valid range of ControlNet addresses is 1...99. The ControlNet adapter uses two rotary switches to set the ControlNet address or, when the switches are set to '00', uses a parameter to set the node address. The adapter reads the values of the switches only at power-up.

### **NVS (Nonvolatile Storage)**

NVS is the permanent memory of a device. Devices such as the adapter and drive store parameters and other information in NVS so that they are not lost when the device loses power. NVS is sometimes called 'EEPROM'.

### **P PCCC (Programmable Controller Communications Command)**

PCCC is the protocol used by some controllers to communicate with devices on a network. Some software products (for example, DriveExplorer and DriveExecutive software) also use PCCC to communicate.

### **Ping**

A message that is sent by a DPI product to its peripheral devices. They use the ping to gather data about the product, including whether it can receive messages and whether they can log in for control.

### **PowerFlex 7-Class (Architecture Class) Drives**

The Allen-Bradley PowerFlex 7-Class family of drives supports DPI and, at the time of publication, includes the PowerFlex 70, PowerFlex 700, PowerFlex 700H, PowerFlex 700S, PowerFlex 700L, and PowerFlex 7000 drives.

### **PowerFlex 750-Series (Architecture Class) Drives**

The Allen-Bradley PowerFlex 750-Series of drives supports DPI and, at the time of publication, includes the PowerFlex 753 and PowerFlex 755 drives.

**Producer/Consumer Network**

On producer/consumer networks, packets are identified by content rather than an explicit destination. If a node needs the packet, it will accept the identifier and consume the packet. The source, therefore, sends a packet once and all the nodes consume the same packet if they need it. Data is produced once, regardless of the number of consumers. Also, better synchronization than Master-Slave networks is possible because data arrives at each node at the same time.

**R Reference/Feedback**

The Reference is used to send a setpoint (for example, speed, frequency, and torque) to the drive. It consists of one word of output to the adapter from the network. The size of the word (either a 16-bit word or 32-bit word) is determined by the drive.

Feedback is used to monitor the speed of the drive. It consists of one word of input from the adapter to the network. The size of the word (either a 16-bit word or 32-bit word) is determined by the drive.

**RSLogix 5/500/5000 Software**

RSLogix software is a tool for configuring and monitoring controllers to communicate with connected devices. It is a 32-bit application that runs on various Windows operating systems. Information about RSLogix software can be found at <http://www.software.rockwell.com/rslogix>.

**RSNetWorx for ControlNet Software**

A software tool for configuring and monitoring ControlNet networks and connected devices. It is a 32-bit application that can be used on computers running various Windows operating systems. Information about RSNetWorx for ControlNet software can be found at <http://www.software.rockwell.com/rsnetworx>.

**S Scanner**

A scanner is a separate module (of a multi-module controller) or a built-in component (of a single-module controller) that provides communication with adapters connected to a network. See also Controller.

**Status Indicators**

LEDs that are used to report the status of the adapter, network, and drive. They are on the adapter and can be viewed on the front cover of the drive when the drive is powered.

**U UDDT (User-Defined Data Type)**

A structure data type that you define during the development of an application (for example, to convert 32-bit REAL parameter data for written and read values to correctly display them in human readable format).

**Update**

The process of updating firmware in a device. The adapter and its connected PowerFlex 7-Class host drive and its peripherals can be updated using various Allen-Bradley software tools. See [Updating the Adapter Firmware on page 3-8](#) for more information.

**Z Zero Data**

When communication is disrupted (for example, a cable is disconnected), the adapter and drive can respond with zero data. Zero data results in the drive receiving zero as values for Logic Command, Reference, and Datalink data. If the drive was running and using the Reference from the adapter, it will stay running but at zero Reference.

**Notes:**

- A**
- adapter
    - applying power, **2-7**
    - commissioning, **2-9**
    - compatible products, **1-3**
    - components, **1-1**
    - configuration tools, **3-1**
    - configuring to use with optional I/O data, **8-3**
    - connecting to the
      - drive, **2-3**
      - network, **2-6**
    - definition, **G-1**
    - features, **1-2**
    - firmware updating, **3-8**
    - grounding, **2-5**
    - installation, **2-1 to 2-9**
    - mounting on the drive, **2-5**
    - node address, **2-2**
    - parameters, **B-1 to B-4**
    - resetting, **3-7**
    - specifications, **A-1**
    - using in a DPI External Comms Kit, **8-1**
    - viewing its status, **3-7**
    - viewing optional I/O diagnostic items, **8-4**
  - applying power to the adapter, **2-7**
  - Assembly object, **C-3**
  - attentions, **1-5**
- B**
- baud rate, *see data rate*
  - bit definitions of Logic Command/Status word for
    - PowerFlex 70/700/700H, and 700L (with 700 Control) drives, **D-1**
    - PowerFlex 700S (Phase II Control) and 700L (with 700S Control) drives, **D-3**
    - PowerFlex 750-Series drives, **D-5**
    - PowerFlex Digital DC drives, **D-7**
  - bridge, **G-1**
  - bus off, **G-1**
- C**
- cables
    - ControlNet, **2-6**
    - DPI Internal Interface, **2-3, 2-4**
  - CAN (Controller Area Network), **G-1**
  - CIP (Common Industrial Protocol), **G-1**
  - CN Active Cfg parameter, **B-2**
  - CN Addr Act parameter, **B-1**
  - CN Addr Cfg parameter, **B-1**
  - CN Rate Act parameter, **B-1**
  - CN Rate Cfg parameter, **B-1**
  - Comm Flt Action parameter, **B-2**
  - commissioning the adapter, **2-9**
  - communication module, *see adapter*
  - compatible products, **1-3**
  - components of the adapter, **1-1**
  - configuration tools, **3-1**
  - Connected Components Workbench software
    - adapter configuration tool, **1-4, 3-1**
    - definition/website, **G-1**
  - connecting adapter to the
    - drive, **2-3**
    - network, **2-6**
  - ControlFLASH software, **G-1**
  - controller, **G-2**
  - ControlLogix controller
    - configuring the I/O, **4-2**
    - explicit messaging, **6-4**
    - using the I/O, **5-14**
  - ControlNet
    - cable, **2-6**
    - connector on adapter, **1-1**
    - data rate, **A-1**
    - example network for
      - ControlLogix controller, **4-2**
      - PLC-5 controller, **4-24**
      - SLC 500 controller, **4-30**
    - network definition, **G-2**
    - objects - list of, **C-1 to C-29**
    - specification, **G-2**
- D**
- data rate, **G-2**
  - Datalink Size parameter, **B-1**
  - Datalinks
    - definition, **G-2**
    - in I/O image, **5-2**
    - using, **5-11**
    - using Datalink D to send optional I/O Board data, **8-2**
  - diagnostic items, **7-4**
  - dimensions, **A-1**

- DPI
    - connector on adapter, **1-1**
    - data rates, **A-1**
    - definition, **G-2**
    - Internal Interface cable, **2-3, 2-4**
    - peripheral, **G-2**
    - products, **1-3, G-2**
  - DPI Alarm object, **C-24**
  - DPI Data Rate parameter, **B-1**
  - DPI Device object, **C-13**
  - DPI Diagnostic object, **C-26**
  - DPI External Comms Kit - using adapter in, **8-1**
  - DPI Fault object, **C-22**
  - DPI I/O Act parameter, **B-3**
  - DPI I/O Cfg parameter, **B-3**
  - DPI Parameter object, **C-16**
  - DPI Port parameter, **B-1**
  - DPI Time object, **C-28**
  - DriveExecutive software
    - adapter configuration tool, **1-4, 3-1**
    - definition/website, **G-3**
  - DriveExplorer software
    - adapter configuration tool, **1-4, 3-1**
    - definition/website, **G-3**
  - drives, *see PowerFlex drives*
  - DriveTools SP software, **G-3**
- E**
- EDS (Electronic Data Sheet) files, **G-3**
  - EEPROM, *see Nonvolatile Storage (NVS)*
  - environmental specifications, **A-2**
  - equipment required, **1-3**
  - events
    - clearing/viewing, **7-6**
    - list of, **7-7**
  - explicit messaging
    - about, **6-2**
    - configuring for
      - ControlLogix controller, **6-4**
      - PLC-5 controller, **6-23**
      - SLC 500 controller, **6-40**
    - definition, **G-3**
    - performing, **6-3**
- F**
- fault action
    - configuring the adapter for, **3-5**
    - definition, **G-3**
  - fault configuration
    - configuring the adapter for, **3-6**
    - definition, **G-3**
  - faults, *see events*
  - features, **1-2**
  - firmware
    - revision, **P-1**
    - update guidelines, **3-8**
  - Fit Cfg A1-D2 In parameters, **B-3**
  - Fit Cfg Logic parameter, **B-3**
  - Fit Cfg Ref parameter, **B-3**
- G**
- grounding the adapter, **2-5**
- H**
- HIM (Human Interface Module)
    - accessing parameters with, **3-2**
    - definition, **G-4**
    - LCD model, **3-2**
    - LED model, **3-2**
  - hold last
    - configuring the adapter for, **3-5**
    - definition, **G-4**
  - Host DPI Parameter object, **C-30**
- I**
- I/O
    - about, **5-1**
    - configuring for
      - ControlLogix controller, **4-2**
      - PLC-5 controller, **4-24**
      - SLC 500 controller, **4-30**
    - configuring the adapter for, **3-3**
    - definition, **G-4**
    - understanding the I/O image, **5-2**
    - using with
      - ControlLogix controller, **5-14**
      - PLC-5 controller, **5-23**
      - SLC 500 controller, **5-38**



I/O Board option - in DPI External Comms Kit  
 configuring adapter to use optional I/O data, **8-3**  
 understanding the I/O image, **8-2**  
 using Datalink D to send I/O data, **8-2**  
 viewing optional I/O diagnostic data, **8-4**

Identity object, **C-2**

idle action, **G-4**

Idle Flt Action parameter, **B-2**

installation

applying power to the adapter, **2-7**

commissioning the adapter, **2-9**

connecting to the

drive, **2-3**

network, **2-6**

preparing for, **2-1**

Internal Interface cables

connecting to the

adapter, **2-4**

drive, **2-4**

illustration, **2-4**

## L

LCD HIM, **3-2**

LED HIM, **3-2**

LEDs, *see status indicators or name of indicator*

Logic Command/Status

bit definitions for

PowerFlex 70/700/700H, and 700L (with  
700 Control) drives, **D-1**

PowerFlex 700S (Phase II Control) and  
700L (with 700S Control) drives, **D-3**

PowerFlex 750-Series drives, **D-5**

PowerFlex Digital DC drives, **D-7**

definition, **G-4**

in I/O image for

ControlLogix controller, **5-2**

PLC-5 controller, **5-4**

SLC 500 controller, **5-6**

using, **5-8**

## M

manual

conventions, **P-1**

related documentation, **P-2**

website, **P-2**

Master-Slave hierarchy

configuring adapter for, **3-4**

definition, **G-5**

mechanical dimensions, **A-1**

messages, *see explicit messaging or I/O*

MOD status indicator

locating, **7-1**

troubleshooting with, **7-2**

mounting the adapter, **2-5**

M-S Input parameter, **B-4**

M-S Input parameter configurations, **3-4**

M-S Output parameter, **B-4**

M-S Output parameter configurations, **3-4**

## N

NET A status indicator

locating, **7-1**

troubleshooting with, **7-3**

NET B status indicator

locating, **7-1**

troubleshooting with, **7-3**

network cable, **2-6**

node address

definition, **G-5**

setting with parameter, **3-3**

setting with switches, **2-2**

Nonvolatile Storage (NVS)

definition, **G-5**

in adapter, **3-1**

in drive, **5-11**

## O

objects - list of, **C-1 to C-29**

ODVA ControlNet specification, **G-2**

## P

Parameter Group object, **C-7**

Parameter object, **C-5**

parameters

accessing, **3-1**

convention, **P-1**

list of, **B-1 to B-4**

restoring to factory-default settings, **3-7**

PCCC (Programmable Controller  
Communications Command), **G-5**

PCCC object, **C-8**

- ping, **G-5**
  - PLC-5 controller
    - configuring the I/O, **4-24**
    - explicit messaging, **6-23**
    - using the I/O, **5-23**
  - PORT status indicator
    - locating, **7-1**
    - troubleshooting with, **7-2**
  - power consumption, **A-1**
  - PowerFlex drives
    - compatible with adapter, **1-3**
    - definition, **G-5**
    - HIM, **3-2**
    - installing adapter on, **2-3**
  - preparing for an installation, **2-1**
  - processor, *see controller*
  - producer/consumer network, **G-6**
  - programmable logic controller, *see controller*
- Q**
- quick start, **1-6**
- R**
- Ref Adjust parameter, **B-4**
  - Ref/Fdbk Size parameter, **B-1**
  - Reference/Feedback
    - definition, **G-6**
    - in I/O image for
      - ControlLogix controller, **5-2**
      - PLC-5 controller, **5-4**
      - SLC 500 controller, **5-6**
    - setting an adjustment, **3-5**
    - using, **5-8**
  - Register object, **C-4**
  - regulatory compliance, **A-2**
  - related documentation, **P-2**
  - requested packet interval, **4-9, 4-21**
  - Reset Module parameter, **B-2**
  - ribbon cable, *see Internal Interface cable*
  - RSLinx Classic software
    - documentation, **P-3**
    - using, **4-1**
  - RSLogix 5/500/5000 software, **G-6**
  - RSNetWorx for ControlNet software
    - configuring/saving I/O to
      - ControlLogix controller, **4-13**
      - PLC-5 controller, **4-25**
      - SLC 500 controller's 1747-SCNR scanner, **4-31**
    - definition/website, **G-6**
- S**
- safety precautions, **1-5**
  - scanner, **G-6**
  - SLC 500 controller
    - configuring the I/O, **4-30**
    - explicit messaging, **6-40**
    - using the I/O, **5-38**
  - specifications for adapter, **A-1**
  - status indicators
    - definition, **G-6**
    - locating, **7-1**
    - MOD, **7-1, 7-2**
    - NET A, **7-1, 7-3**
    - NET B, **7-1, 7-3**
    - normal operation, **2-7**
    - PORT, **7-1, 7-2**
    - troubleshooting with, **7-2 to 7-3**
    - understanding, **7-1**
  - switches to set node address, **2-2**
- T**
- technical support, **P-2**
  - tools required, **1-3**
  - troubleshooting, **7-1 to 7-8**
- U**
- UDDT (User-Defined Data Type), **G-6**
  - update
    - definition, **G-7**
    - guidelines, **3-8**

**W**

## website

- Connected Components Workbench software, **G-1**
- ControlNet, **G-2**
- DriveExecutive software, **G-3**
- DriveExplorer software, **G-3**
- DriveTools SP software, **G-3**
- EDS files, **G-3**
- manuals, **P-2**
- ODVA (Open DeviceNet Vendor's Association), **G-2**
- RSLogix 5/500/5000 software, **G-6**
- RSNetWorx for ControlNet software, **G-6**

wiring, *see cables*

**Z**

## zero data

- configuring the adapter for, **3-5**
- definition, **G-7**

**Notes:**



# Rockwell Automation Support

Rockwell Automation provides technical information on the Web to assist you in using its products. At <http://www.rockwellautomation.com/support/>, you can find technical manuals, a knowledge base of FAQs, technical and application notes, sample code and links to software service packs, and a MySupport feature that you can customize to make the best use of these tools.

For an additional level of technical phone support for installation, configuration, and troubleshooting, we offer TechConnect support programs. For more information, contact your local distributor or Rockwell Automation representative, or visit <http://www.rockwellautomation.com/support/>.

For U.S. Allen-Bradley Drives Technical Support — Tel: (1) 262.512.8176, Fax: (1) 262.512.2222, Email: [support@drives.ra.rockwell.com](mailto:support@drives.ra.rockwell.com), Online: [www.ab.com/support/abdrives](http://www.ab.com/support/abdrives)

## Installation Assistance

If you experience a problem within the first 24 hours of installation, review the information that is contained in this manual. You can contact Customer Support for initial help in getting your product up and running.

United States or Canada	1.440.646.3434
Outside United States or Canada	Use the <a href="#">Worldwide Locator</a> at <a href="http://www.rockwellautomation.com/support/americas/phone_en.html">http://www.rockwellautomation.com/support/americas/phone_en.html</a> , or contact your local Rockwell Automation representative.

## New Product Satisfaction Return

Rockwell Automation tests all of its products to ensure that they are fully operational when shipped from the manufacturing facility. However, if your product is not functioning and needs to be returned, follow these procedures.

United States	Contact your distributor. You must provide a Customer Support case number (call the phone number above to obtain one) to your distributor to complete the return process.
Outside United States	Please contact your local Rockwell Automation representative for the return procedure.

## Documentation Feedback

Your comments will help us serve your documentation needs better. If you have any suggestions on how to improve this document, complete this form, publication [RA-DU002](#), available at <http://www.rockwellautomation.com/literature/>.

Rockwell Otomasyon Ticaret A.Ş., Kar Plaza İş Merkezi E Blok Kat:6 34752 İçerenköy, İstanbul, Tel: +90 (216) 5698400

[www.rockwellautomation.com](http://www.rockwellautomation.com)

### Power, Control and Information Solutions Headquarters

Americas: Rockwell Automation, 1201 South Second Street, Milwaukee, WI 53204-2496 USA, Tel: (1) 414.382.2000, Fax: (1) 414.382.4444  
Europe/Middle East/Africa: Rockwell Automation, Pegasus Park, De Kleetlaan 12a, 1831 Diegem, Belgium, Tel: (32) 2 663 0600, Fax: (32) 2 663 0640  
Asia Pacific: Rockwell Automation, Level 14, Core F, Cyberport 3, 100 Cyberport Road, Hong Kong, Tel: (852) 2887 4788, Fax: (852) 2508 1846

Publication 20COMM-UM003F-EN-P – March, 2013  
Supersedes 20COMM-UM003E-EN-P – August, 2007

Copyright © 2013 Rockwell Automation, Inc. All rights reserved. Printed in USA.