

MobileView Tethered Operator Terminal

Catalog Numbers 2711T-B10I1N1, 2711T-B10R1K1, 2711T-B10R1M1, 2711T-F10GIN1, 2711T-T10G1N1, 2711T-T10I1N1-TC, 2711T-T10R1N1, 2711T-BRACKET, 2711T-VMBRACKET, 2711T-JBIP20DC, 2711T-JBIP65DC1, 2711T-JBIP65DM1, 2711T-JBBKCOVER, 2711T-5MCABLE, 2711T-5MCABLE2, 2711T-10MCABLE, 2711T-10MCABLE2, 2711T-15MCABLE, 2711T-15MCABLE2, 2711T-JUMP, 2711T-22JUMP



Important User Information

Read this document and the documents listed in the additional resources section about installation, configuration, and operation of this equipment before you install, configure, operate, or maintain this product. Users are required to familiarize themselves with installation and wiring instructions in addition to requirements of all applicable codes, laws, and standards.

Activities including installation, adjustments, putting into service, use, assembly, disassembly, and maintenance are required to be carried out by suitably trained personnel in accordance with applicable code of practice.

If this equipment is used in a manner not specified by the manufacturer, the protection provided by the equipment may be impaired.

In no event will Rockwell Automation, Inc. be responsible or liable for indirect or consequential damages resulting from the use or application of this equipment.

The examples and diagrams in this manual are included solely for illustrative purposes. Because of the many variables and requirements associated with any particular installation, Rockwell Automation, Inc. cannot assume responsibility or liability for actual use based on the examples and diagrams.

No patent liability is assumed by Rockwell Automation, Inc. with respect to use of information, circuits, equipment, or software described in this manual.

Reproduction of the contents of this manual, in whole or in part, without written permission of Rockwell Automation, Inc., is prohibited

Throughout this manual, when necessary, we use notes to make you aware of safety considerations.



WARNING: Identifies information about practices or circumstances that can cause an explosion in a hazardous environment, which may lead to personal injury or death, property damage, or economic loss.



ATTENTION: Identifies information about practices or circumstances that can lead to personal injury or death, property damage, or economic loss. Attentions help you identify a hazard, avoid a hazard, and recognize the consequence.

IMPORTANT

Identifies information that is critical for successful application and understanding of the product.

Labels may also be on or inside the equipment to provide specific precautions.



SHOCK HAZARD: Labels may be on or inside the equipment, for example, a drive or motor, to alert people that dangerous voltage may be present.



BURN HAZARD: Labels may be on or inside the equipment, for example, a drive or motor, to alert people that surfaces may reach dangerous temperatures.



ARC FLASH HAZARD: Labels may be on or inside the equipment, for example, a motor control center, to alert people to potential Arc Flash. Arc Flash will cause severe injury or death. Wear proper Personal Protective Equipment (PPE). Follow ALL Regulatory requirements for safe work practices and for Personal Protective Equipment (PPE).

	Preface	
	Summary of Changes	7
	Abbreviations	8
	Additional Resources	8
	 Chapter 1	
Features	Overview	9
	MobileView 2711T Terminal Options	10
	MobileView 2711T Terminal Component Description	11
	MobileView 2711T Terminal Dimensions and Weight	11
	Membrane Keypad	12
	Resistive Touch Screen	13
	USB 2.0 Port	13
	 Chapter 2	
Safety Precautions and Elements	General Safety	16
	Programmable Electronic Systems	16
	Power Supply	17
	Enabling Switch	17
	Enabling Switch Connection Example with a Control Relay ..	17
	Foreseeable Misuse of the Enabling Switch	19
	Emergency Stop (E-stop) Push Button	19
	Risk Assessment of Machinery	20
	MobileView 2711T Terminal Operation	20
	MobileView Junction Box Operation	21
	 Chapter 3	
Operate the Terminal	Install a Connection Cable to a MobileView Terminal	23
	Remove the Back Cover	23
	Install the Connection Cable to the MobileView 2711T Terminal	25
	Relocate the Connection Cable	27
	Adjust the Touch Screen	30
	Adjust the Display Brightness	30
	Recalibrate the Touch Screen	30
	Shut Down the MobileView 2711T Terminal	31
	Disconnect Power from the MobileView 2711T Terminal ...	31
	Install the Mounting Brackets	32

Install and Operate the Junction Boxes

Chapter 4

Junction Box Overview 35

The MobileView IP20 Junction Box 36

 Mount and Connect the IP20 Junction Box 36

 Connect a First Generation MobileView Terminal to the IP20 Junction Box 36

 Connect to an Ethernet Network 39

The MobileView IP65 Junction Box 39

 Mount the IP65 Junction Box Back Plate 40

 Temporarily Mount the IP65 Junction Box 41

 Wire the 2711T-JBIP65DC1 Junction Box 42

 Configure the 2711T-JBIP65DC1 Junction Box 46

 Configure the 2711T-JBIP65DM1 Junction Box 48

 Mount the IP65 Junction Box to Its Back Plate 48

 Connect M12 On-Machine Connectors to the 2711T-JBIP65DM1 Junction Box 49

 Connect Power to IP65 Junction Boxes 50

 IP65 Junction Box Status Lights 52

 Connect a Second Generation MobileView Terminal to an IP65 Junction Box 54

 Connect a Black Bridge Connector to an IP65 Junction Box .. 54

Set Up the BIOS Settings and Desktop Icons

Chapter 5

End User Setup Procedure 55

Desktop Overview 56

 Buttons on the Task Bar 57

Enhanced Write Filter (EWF)..... 57

FTView ME Station 58

 Transfer the MER File With a USB Storage Device..... 58

 Transfer the MER File Through the Ethernet Network..... 61

 FactoryTalk View ME Station Software Patch 64

KEPServer Enterprise..... 67

VNC Server 67

System Config 69

 Update the Firmware 69

 Update the BIOS..... 71

Network Settings..... 72

Remote Desktop 73

Touch Calibration 74

Rescue..... 75

Restore the Default BIOS..... 75

Change the BIOS Password 77

Back Up the Operating System Image..... 80

Restore the Operating System Image..... 83

	Chapter 6	
Maintain and Troubleshoot the MobileView Terminal and IP65 Junction Box	Clean the MobileView 2711T Terminal	87
	Handle and Care for the MobileView 2711T Terminal and IP65 Junction Box.	88
	Chemical Resistance.	88
	Real-time Clock Battery	89
	Troubleshoot the MobileView 2711T Terminal	89
	Troubleshoot the IP65 Junction Box.	90
	Provide Information to Technical Support	91
	Ship or Transport a MobileView Device.	91
	Dispose of a MobileView Device.	92
	Appendix A	
Specifications	MobileView Terminals	93
	IP20 Junction Box.	94
	IP65 Junction Boxes.	95
	MobileView Accessories	96
	Standard and Agency Certifications.	97
	Index	
	99

Notes:

This manual is a user guide for MobileView™ 2711T tethered operator terminals and MobileView junction boxes. It provides procedures to the following:

- Install a MobileView 2711T terminal and junction box.
- Make MobileView 2711T terminal and junction box connections.
- Operate the MobileView 2711T terminal and junction box.
- Troubleshoot MobileView 2711T terminals and IP65 junction boxes.

IMPORTANT This publication must be kept throughout the entire service life of the MobileView 2711T terminal and junction box.

Summary of Changes

This manual contains new and updated information as indicated in the following table.

Topic	Page
Replaced 'address' with 'identification (ID) number' in the second row of the Then column.	43
Revised the first two sentences in the second Description table row in Figure 10.	46
Added the BoxID artwork in the BoxID Functionality subsection.	47
Revised the first paragraph in the BoxID Functionality subsection.	47
Added the Attention table in the BoxID Functionality subsection.	47
Revised table title and all column headings in Table 6.	47
Revised 'M12 Connector Type' column heading to 'Connector Type' in Table 7.	49
Added footnote to Table 7 about Mini-DIN exception to M12 connectors.	49
Updated artwork in M12 Ethernet Pin Descriptions subsection.	49
Updated artwork in M12 Dry Contact, E-stop, and Enabling Device Pins Description subsection.	50
Updated artwork in Mini-DIN DC Power Pin Descriptions subsection.	50
Revised pin descriptions in table in Mini-DIN DC Power Pin Descriptions subsection.	50

Abbreviations

This publication can use the following abbreviations.

Abbr	Description	Abbr	Description
BIOS	Basic input/output system	LCD	Liquid crystal display
BSS	Bootable service system	OS	Operating system
DHCP	Dynamic host configuration protocol	PCB	Printed circuit board
DRAM	Dynamic random access memory	SD	Secure Digital
EEA	European Economic Area	TFT	Thin film transistor
EMC	Electromagnetic Compatibility	TFT	Thin film transistor
ESD	Electrostatic discharge	UPD	Updated program data
EFW	Enhanced write filter	USB	Universal serial bus
HMI	Human machine interface	VMDK	Virtual machine disk
IP	Internet protocol	VNC	Virtual network computing
ISO	International Organization for Standardization	WXGA	Wide extended graphics array
ISP	Internet service provider		

Additional Resources

These documents contain more information to related products from Rockwell Automation.

Resource	Description
FactoryTalk® View Machine Edition User Guide, publication VIEWME-UM004	Provides comprehensive information about FactoryTalk View Machine Edition, procedures to create and run an automation application, and reference information.
Industrial Automation Wiring and Grounding Guidelines, publication 1770-4.1	Provides general guidelines to install a Rockwell Automation® industrial system.
Product Certifications website, http://www.rockwellautomation.com/rockwellautomation/certification/overview.page	Provides declarations of conformity, certificates, and other certification details.

You can view or download publications at <http://www.rockwellautomation.com/literature>. To order paper copies of technical documentation, contact your local Allen-Bradley distributor or Rockwell Automation sales representative.

Features

Topic	Page
Overview	9
MobileView 2711T Terminal Options	10
MobileView 2711T Terminal Component Description	11
MobileView 2711T Terminal Component Description	11
MobileView 2711T Terminal Dimensions and Weight	11
Membrane Keypad	12
Resistive Touch Screen	13
USB 2.0 Port	13

Overview

The MobileView™ 2711T family of human machine interface (HMI) devices have a rugged design with features that include a 3-position enable switch, touch and function keys, and stop push buttons⁽¹⁾. These features let you access the safety system of a machine and the general interface to its control system.

There are two generations of MobileView 2711T terminals. First generation terminals use a 20-pin connection cable with a silver connector to connect to an IP20 junction box. Second generation terminals use a 22-pin connection cable with a black connector to connect to one of two available IP65 junction boxes. Because of the pin differences, you cannot mix components between generations.

One of the second generation MobileView terminals, cat. no. 2711T-T10I1N1-TC, is a thin client model without an operating system but is set for PXE boot into a thin client server. This terminal is configured to work with ThinManager® software. To learn more about how to PXE boot into a ThinManager server, access the Rockwell Automation Knowledgebase link at <https://rockwellautomation.custhelp.com/> and search for AID 1043685.

There are two IP65 junction boxes that work with second generation MobileView terminals. One junction box has cord grip connections, and the other junction box has M12 On-Machine™ connections. Both IP65 junction boxes have LED lights and a status indicator bar on their front plate that can signify different operating and error states.

(1) Three of the first generation MobileView terminals are equipped with a red-yellow emergency stop (E-stop) push button, both second generation MobileView terminals are equipped with an illuminated red E-stop push button, and two of the first generation MobileView terminals are equipped with a gray stop button that is not classified as an E-stop button.

MobileView 2711T Terminal Options

[Table 1](#) summarizes the options available for the 2711T MobileView tethered operator terminals. A comparative summary of features for the MobileView terminals is in Appendix A, [MobileView Terminals on page 93](#).

Table 1 - First Generation MobileView Terminal Options

Cat. No. (2711T-)	Display Size (in.)	Touch Screen	Function Keys	3-position Enabling Switch	3-position Key Switch	Momentary Button	2-circuit Push Button	
							E-stop (red/yellow)	Stop (gray)
B10R1K1	10.1	Yes	Yes	Yes	Yes	No	Yes	No
B10R1M1					No	Yes		
F10G1N1					No	No	Yes	
T10G1N1			Yes			No		
T10R1N1								

Table 2 - Second Generation MobileView Terminal Options

Cat. No. (2711T-)	Display Size (in.)	Touch Screen	Function Keys	3-position Enabling Switch	3-position Key Switch	Momentary Button	2-circuit Push Button	
							Illuminated E-stop	Stop (gray)
B10I1N1	10.1	Yes	Yes	Yes	No	No	Yes	No
T10I1N1-TC			No					

See [MobileView Accessories on page 96](#) for what accessories are available for each generation of MobileView terminals.

MobileView 2711T Terminal Component Description

The following illustration shows the location of key hardware components.

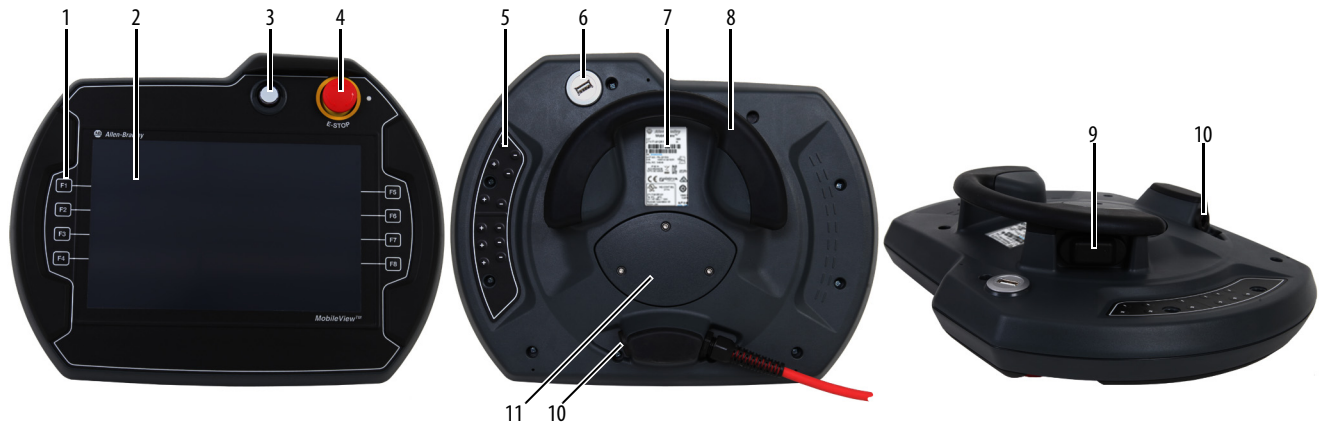

Item	Description	First Generation		Second Generation
		Standard	Option	Standard
1	Membrane keypad with tactile feedback		•	• ⁽²⁾
2	10 inch WXGA (1280 x 800 pixels) TFT color LCD display with analog-resistive touch screen	•		•
3	<ul style="list-style-type: none"> • Illuminated momentary push button, normally open OR • 3-position key switch 		• •	— —
4	<ul style="list-style-type: none"> • Red emergency stop (E-stop) button, twin-circuit, N.C. contacts, 24V DC, 500 mA max OR • Illuminated red E-stop button, twin circuit, N.C. contacts, 24V DC, 500 mA max 	• ⁽¹⁾	—	— •
5	Backside membrane keypad with tactile feedback		•	• ⁽²⁾
6	USB port	•		•
7	Product nameplate	•		•
8	Handle to hold the terminal, to store the connection cable, and to attach to the mounting bracket	•		•
9	3-position, twin circuit, enabling switch for safety system interface	•		•
10	Plug for alternate cable outlet not used (meets degree protection IP65)	•		•
11	Back cover to access connection compartment	•		•

(1) 2711T-F10GIN1 and 2711T-T10G1N1 MobileView terminals are equipped with a gray push button that is classified as a stop button but not an E-stop button.

(2) 2711T-T1011N1-TC MobileView terminal does not have this feature.

MobileView 2711T Terminal Dimensions and Weight



Membrane Keypad

The MobileView 2711T terminal has a membrane keypad with stainless steel dome switches for tactile feedback.

IMPORTANT The 2711T-T101N1-TC MobileView terminal does not have the function keys shown in this section.



The keys on the MobileView 2711T terminal keypad operate similar to the keyboard of a Windows personal computer. Some 3-key combinations are supported. The following table shows the corresponding keyboard shortcut for each function key.

IMPORTANT The following table applies to Microsoft Windows OS keyboard shortcuts. All MobileView terminal keys are also mappable within a FactoryTalk® Machine Edition (ME) application.

Function Key	Keyboard Shortcut
F1	F1
F2	F2
F3	F3
F4	F4
F5	F5
F6	F6
F7	F7
F8	F8
1+	Right ALT+F1
1-	Right ALT+F2

Function Key	Keyboard Shortcut
2+	Right ALT+F3
2-	Right ALT+F4
3+	Right ALT+F5
3-	Right ALT+F6
4+	Right ALT+F7
4-	Right ALT+F8
5+	Right ALT+F9
5-	Right ALT+F10
6+	Right ALT+F11
6-	Right ALT+F12

Resistive Touch Screen

The touch screen is calibrated before shipment. You can recalibrate the touch screen. For more information, see [Touch Calibration on page 74](#).

Resistive touch screens are activated when you apply pressure to the touch screen with your finger. You can operate a resistive touch screen while gloves are worn.

Resistive touch screens accept only single finger input. Multi-finger input or 'palm contact' can cause an incorrect touch input.



ATTENTION: Do not use sharp objects, such as a screwdriver, on the touch screen. Scratching the surface of the touch screen can damage the display and compromise the IP rating.

USB 2.0 Port

Use the USB 2.0 port on the back of the terminal to perform the following tasks:

- Connect a USB storage device for the following:
 - Update or restore the BIOS settings
 - Back up or restore the OS image
 - Copy or move files to the internal Secure Digital (SD) card
- Connect a USB keyboard or mouse
- Connect a USB hub to use multiple USB devices simultaneously

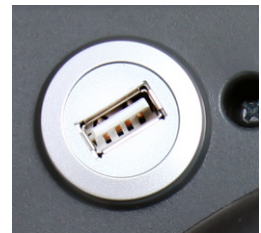

IMPORTANT Any task that is performed through the USB port must be done while the MobileView 2711T terminal is not used for operation. Do not use or keep a USB storage drive connected in the USB port while the MobileView 2711T terminal is operated.

Notes:

Safety Precautions and Elements

Topic	Page
General Safety	16
Power Supply	17
Enabling Switch	17
Emergency Stop (E-stop) Push Button	19
MobileView 2711T Terminal Operation	20

General Safety

It is important to follow the instructions in this document in all circumstances. Failure to do so can result in potential sources of danger or the possible override of safety features that are integrated in the terminal.

Besides the safety instructions in this document, you must also use safety precautions and accident prevention measures that are appropriate to the situation.



ATTENTION: Consider or perform the following as part of general safety.

- Verify that interrupted processes can be properly restarted after power failures or power dips. Do not allow any dangerous operating conditions to occur, even temporarily.
- In situations where faults that occur within the automation system could cause personal injury or significant damage to machinery and equipment, take extra safety measures to confirm that the system remains in an acceptable operating condition.
- When applying functional safety, restrict access to qualified, authorized personnel who are trained and experienced.
- Verify that unauthorized persons are not allowed to adjust settings or make memory modifications that can lead to dangerous situations.
- Test the functionality of the E-stop button and enabling switch at least once every six months. Verify that the machine or plant operation stops when the button is pushed.
- If the MobileView™ 2711T terminal and controller do not communicate with a point-to-point connection, then keypad data could transmit with a delay. An Ethernet switch that is used between the MobileView 2711T terminal and controller is recommended for a higher speed connection.
- When a MobileView 2711T terminal has been exposed to shock (for example, it is dropped on the ground), test to verify that the E-stop button and enabling switch still function properly.
- The USB port on the backside of the MobileView 2711T terminal is only for maintenance. Do not operate the terminal while a USB drive is connected to it.
- Risk assessment and risk reduction are important precautionary measures for machine safety. For more information, see ISO 12100.

Proper care and handling contribute to MobileView terminal and junction box safety. For more information on care and handling, see [Handle and Care for the MobileView 2711T Terminal and IP65 Junction Box on page 88](#).

Programmable Electronic Systems



ATTENTION: Personnel responsible for the application of safety-related Programmable Electronic Systems (PES) shall be aware of the safety requirements in the application of the system and shall be trained in using the system.

Power Supply

All MobileView 2711T terminals meet the Safety Class III requirements for electrical shock in accordance with EN 61131-2. See [Appendix A](#) for the DC power supply requirements for a MobileView 2711T terminal, junction box, and connection cable.



SHOCK HAZARD: Supply the MobileView terminal and junction box exclusively from power sources with SELV or PELV circuit protection according to EN 61131-2.

Only connect voltages and circuits that are separated from dangerous voltages (for example, by means of sufficient insulation) to connections, terminals or interfaces up to a rated voltage of 50V DC.

Specifications of power supply lines in the connection cables are:

- Cross section: 26 AWG (0.126 mm²)
- Material: zinc-coated copper strand
- Line resistance: <136 Ω/km (<219 Ω/mi)



WARNING: The 24V DC power supply to the control cabinet or operator panel must have a fuse that is rated 3.15A (max) and complies with UL 248.

Failure to install a fuse can result in fire from component failure.

Enabling Switch

On the MobileView 2711T terminal, the enabling switch consists of a 3-position operating element with two independent circuits.



WARNING: Only the operator of the enabling device on the MobileView 2711T terminal is allowed in the dangerous area or zone.

The enabling switch is only suitable as a safety device if the operator of the enabling switch on the MobileView 2711T terminal recognizes the dangerous situation and reacts in time to avoid the danger.

Consider reduced speed of movements as a precautionary measure, which can be done through the risk assessment of machinery.

Enabling Switch Connection Example with a Control Relay

[Figure 3 on page 18](#) shows suggested wiring for the enabling switch with an Allen-Bradley® safety control relay. If this wiring example is followed, then the safety function meets Category 4, Performance Level e (CAT. 4, PLe) in accordance with ISO 13849-1 or SIL 3 in accordance with EN 61508.

Figure 3 - Enabling Switch Wiring Example for a First Generation MobileView Terminal Connected to an IP20 Junction Box

Table 3 - Callouts

Item	Description
1	MobileView 2711T terminal
2	Enabling switches circuit board
3	Connection cable wires
4	Junction box input connection
5	Control cabinet
6	Junction box terminals
7	Allen-Bradley Guardmaster® safety relay
8	3-phase motor

Table 4 - Actuating Elements

Item	Description
Voltage, nom	24V DC (typical) 30V DC (max)
Current, nom	500 mA (typical)
Inductive load, max	700 mA (DC13)

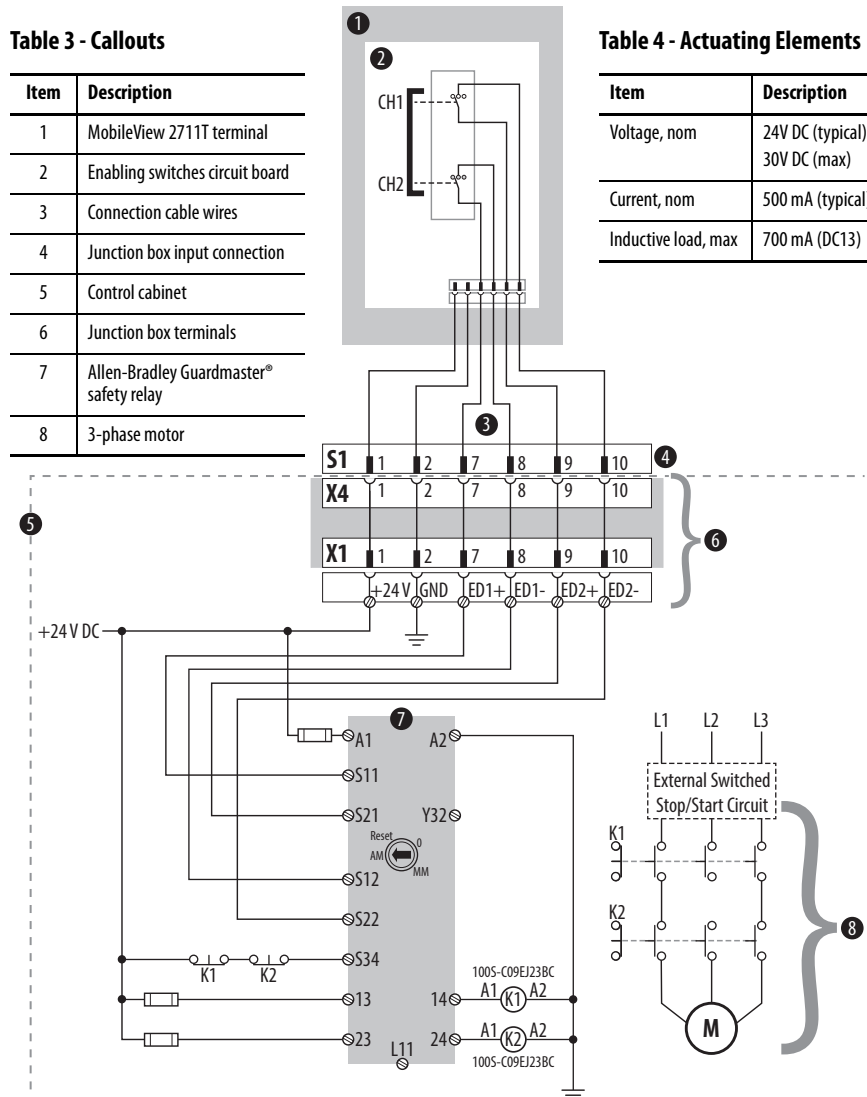

- Only if both channels (CH1 and CH2) of the enabling switch are activated ‘simultaneously’ do output contacts 13-14 and 23-24 close, and output relays K1 and K2 energize.
- The output relays K1 and K2 do not energize if:
 - Only one enabling channel is activated.
 - The tolerance value for the simultaneity period is exceeded.
 - The feedback control loop at S34 is open.
- If one enabling channel is released after being simultaneously activated, the forced-guided output contacts 13-14 and 23-24 open, and output relays K1 and K2 return to their initial position. The output relays only energize again after both enabling channels have been released and operate simultaneously again.

In this way, the enabling switches avoid the one single error that makes the safety function inoperable. At the least, one error is recognized at the next cycle.

Foreseeable Misuse of the Enabling Switch

Foreseeable misuse is when the enabling switch is modified so it stays in the enabling position. The foreseeable misuse of the enabling switch must be restricted. The following measures are recommended, which cause the machine to stop in manual mode.

- Inquiry of the enabling switch when you turn on the machine/plant, and inquiry of the enabling switch when you change the operating mode from automatic to manual (the enabling switch must not be in the enabling position).
- The enabling switch must be released within a defined time period and pushed into the enabling position again, with the time length defined by the activity.

Emergency Stop (E-stop) Push Button

The E-stop push button of a MobileView 2711T terminal meets the requirements of ISO 13850. The button must be designed as a Category 0 or Category 1 emergency stop by the risk assessment for the machine. The connection of the force-guided contacts to an appropriate monitoring system must meet the safety level that results from the risk assessment of the machine. See [Risk Assessment of Machinery on page 20](#).

The E-stop has two potential-free, normally closed contacts to connect external peripherals, a nominal operating voltage of 24V (safety low voltage in accordance with EN 61131-2), and a maximum operating current of 500 mA at 24V DC.



WARNING: E-stop push buttons (red-yellow in color) that are not fully functional can have fatal consequences. E-stop push buttons must be effective under all circumstances in all operating modes of a machine or plant.

- When the E-stop push button is not wired into an emergency stop circuit, the MobileView 2711T terminal must be stored where it is not visible to operators.
- The reset of an activated E-stop push button must not result in the uncontrolled startup of machines or installations.
- The E-stop push button does not replace other safety devices or E-stop buttons mounted directly on machines.
- Do not use MobileView 2711T terminals with red-yellow E-stop buttons in applications where the terminal is plugged in and out of junction boxes frequently or meant for temporary use. Only MobileView 2711T terminals with gray stop push buttons are meant for these applications.
- Test the functionality of the E-stop push button at least once every six months. Verify that machine or plant operation stops when the button is pushed.
- When a MobileView 2711T terminal has been exposed to shock (for example, it is dropped on the ground), test to verify that the E-stop push button still functions properly.

Risk Assessment of Machinery

For the risk assessment for the machinery, use the standards in ISO 12100, “Safety of machinery - General principles for design - Risk assessment and risk reduction.”

[Figure 3 on page 18](#) shows how a first generation MobileView 2711T terminal uses an Allen-Bradley control relay with the enabling switches. The control system must be designed for the safety level that results from the risk assessment of ISO 12100.

MobileView 2711T Terminal Operation

The MobileView 2711T terminal is a high-quality device that is equipped with state-of-the-art electronics.



ATTENTION: To avoid malfunctions or damage through improper handling, follow these instructions during operation.

- Do not operate the terminal if the cable is damaged or pinched. To avoid damaging the cable, do not place the cable over or around sharp objects.
 - When the terminal is not in use, hang the terminal on the mounting bracket (ordered separately) or place inside a cabinet or enclosure.
 - To avoid impact damage to the terminal, do not set the terminal on unstable surfaces and keep the cable clear of high traffic areas.
 - ~ If the terminal falls to the ground, verify that the emergency stop switch and enabling switch remain operable before you use the terminal on any machinery.
 - To avoid damage to the operating elements, do not set the terminal on its operating side.
 - Do not set the terminal near heat sources and avoid direct sunlight.
 - Do not expose the terminal to strong magnetic fields or excessive vibrations, dust, or humidity.
 - Use a soft, damp cloth with 50% water and 50% isopropyl alcohol to clean the operating panel and operating elements. Do not use solvents, scouring agents, or scrubbing sponges.
 - Help prevent foreign objects or liquids from getting into the terminal. Check the protective covers of the device regularly. Verify that all screws are firmly tightened and that the housing and cable entrance are not damaged.
 - Turn off the power supply before you remove the back cover of the MobileView 2711T terminal. When the back cover is removed, the terminal is sensitive to electrostatic discharge (ESD).
 - If the terminal exhibits any anomaly, have the unit thoroughly and fully tested by the manufacturer or authorized repair dealer before you operate the terminal again.
 - Do not use sharp objects, such as a screwdriver, on the touch screen. Scratching the surface of the touch screen can damage the display and compromise the IP rating.
-

MobileView Junction Box Operation

MobileView IP20 and IP65 junction boxes are high-quality devices that are equipped with state-of-the-art electronics.



ATTENTION: To avoid malfunctions or damage through improper handling, follow these instructions during operation.

- Do not operate a junction box if the cable is damaged or pinched. To avoid damaging the cable, do not place the cable over or around sharp objects.
- Do not mount a junction box near heat sources and avoid direct sunlight.
- Do not expose the a junction box to strong magnetic fields or excessive vibrations, dust, or humidity.
- Use a soft, damp cloth with water to clean IP65 junction boxes. Do not use solvents, scouring agents, or scrubbing sponges.
- Help prevent foreign objects or liquids from getting into a junction box. Check the protective covers of the device regularly. Verify that all screws are firmly tightened and that the housing and cable entrance are not damaged.
- Turn off the power supply before you remove an IP65 junction box from its cover plate. When the back plate is removed, the junction box is sensitive to ESD.
- If a junction box exhibits any anomaly, have the device thoroughly and fully tested by the manufacturer or authorized repair dealer before you operate the junction box again.

Notes:

Operate the Terminal

Topic	Page
Install a Connection Cable to a MobileView Terminal	23
The 22-pin MobileView Connection Cable	29
Adjust the Touch Screen	30
Shut Down the MobileView 2711T Terminal	31
Install the Mounting Brackets	32

Install a Connection Cable to a MobileView Terminal

This section provides details on the following topics:

- [Remove the Back Cover](#)
- [Install the Connection Cable to the MobileView 2711T Terminal](#)
- [Relocate the Connection Cable](#)

IMPORTANT

20-pin connection cables work only with first generation MobileView™ 2711T terminals and IP20 junction boxes. Its cable connector (shown as S1 on [page 28](#)) is silver.

22-pin connection cables are meant for second generation MobileView 2711T terminals and IP65 junction boxes. Its cable connector (shown as S1 on [page 29](#)) is black.

The following installation instructions apply to either connection cable type.

Remove the Back Cover

This section shows how to remove the back cover of the MobileView™ 2711T terminal. When the back cover is removed, you have access to the area that contains all connectors except the USB port.



SHOCK HAZARD: Disconnect all power to the MobileView 2711T terminal before you remove its back cover.

When the back cover is removed, the MobileView 2711T terminal is sensitive to electrostatic discharge (ESD).

1. Place the MobileView 2711T terminal with the display side down on a stable, flat surface free of debris.

- Use a Torx T10 screwdriver to remove the three screws that secure the back cover.

TIP The 'Image Applied' label on the back cover was part of the manufacturing process. Therefore, you can remove and discard this label.

- Carefully lift off the back cover and set it aside.



Figure 1 shows the main circuit board of the MobileView 2711T terminal with the back cover removed.

Figure 1 - Main Circuit Board with Back Cover Removed

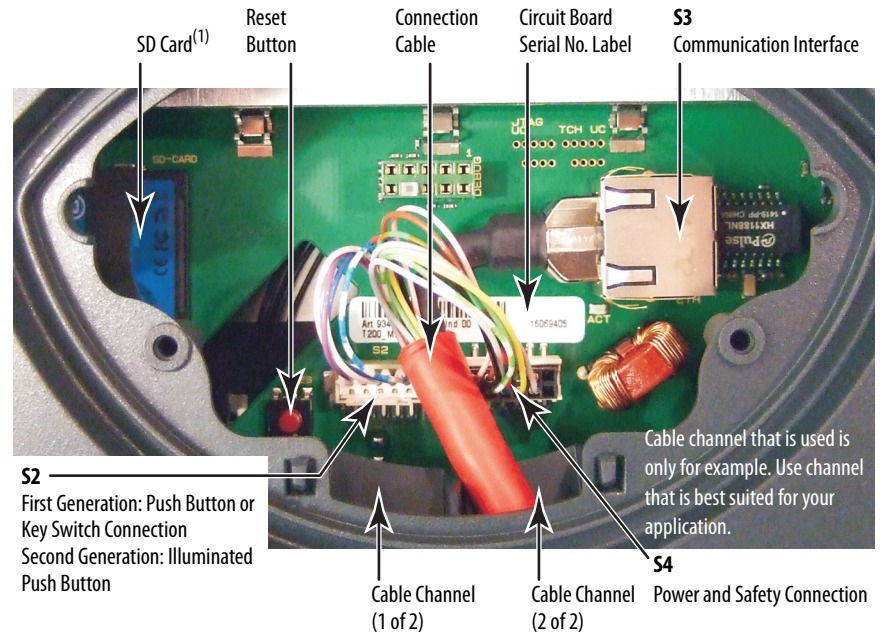

⁽¹⁾ The 2711T-T10I1N1-TC MobileView terminal does not have this feature.

IMPORTANT Use the reset button when MobileView 2711T terminal functionality 'locks up' and you cannot restart from the terminal-desktop screen.

Install the Connection Cable to the MobileView 2711T Terminal

The connection cable can be attached on the right or left side of the MobileView 2711T terminal for right- or left-hand operation.

IMPORTANT The MobileView 2711T terminal is shipped with the cable connection port open for right-hand operation. For more information, see [Figure 2](#).

Use the following tools to install the connection cable.

- 19 mm open-end wrench or spanner
- Torx T10 screwdriver
- 8 mm hex key

To install the cable, perform the following steps.

1. Decide on which cable-connection port of the terminal to install the cable; see [Figure 2](#).

Figure 2 - Cable Connections on MobileView 2711T Terminals

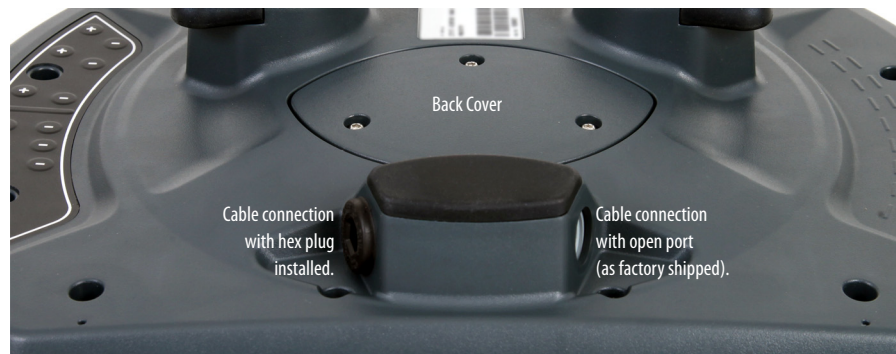

IMPORTANT The MobileView 2711T terminal is shipped with the above cable-connection port open for right-hand operation.

When the cable is connected to this port, you can hold the terminal with your left arm, operate the enabling switch with your left hand, and operate the terminal touch screen with your right hand.

2. If you want left-hand operation, remove the plug with an 8 mm hex key. Set the plug aside.
3. Remove the back cover as detailed on [page 23](#).

4. If present, unscrew and remove the gray fitting from the connector-cable mounting assembly.
5. Unscrew the strain relief from the connector-cable mounting assembly to allow the red cable to slide freely.

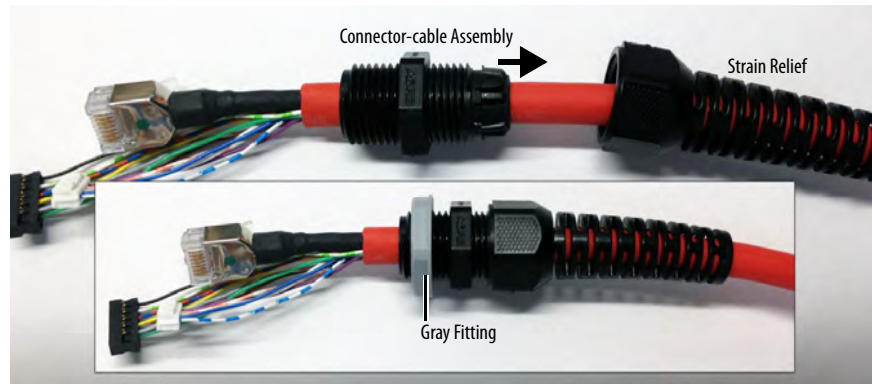

6. Gently feed the three terminals at the end of the red cable into the chosen cable connection and up through the cable channel.

IMPORTANT Do not force the cable terminals through the channel. If you encounter resistance, slowly pull the cable towards you until it moves freely again.

If necessary, slide the connector-cable assembly farther down the cable to assist cable feed through the channel.

7. When the three terminals reach the main circuit board, carefully plug each terminal into its connection. See [Figure 1 on page 24](#) for where each terminal is connected.

IMPORTANT Verify that there is a snap sound when you plug each terminal into its corresponding connection, which confirms that the terminal is properly connected.

8. After each terminal is securely connected, reinstall the back cover.
Use a Torx T10 screwdriver to reinstall the three cover screws.
9. Install the connector-cable mounting assembly into the cable connection of the MobileView 2711T terminal.
10. Reinstall the strain relief to the connector-cable mounting assembly.
11. Tighten the strain relief and the connector-cable mounting assembly with the 19 mm open-end wrench or spanner.
Torque the connector-cable mounting assembly to 1.2 N•m (10.6 lb•in.).
12. If you chose left-hand operation, reinstall the plug in the open cable-connection port with an 8 mm hex key.
Torque the plug to 1.2 N•m (10.6 lb•in.).

Relocate the Connection Cable

Use the following tools to relocate the connection cable.

- 19 mm open-end wrench or spanner
- Torx T10 screwdriver
- 8 mm hex key

To relocate the cable, perform the following steps.

1. Remove the plug with the 8 mm hex key from the side where you are going to relocate the cable.

Set the plug aside.

TIP See [step 5](#) on [page 26](#) to identify the components in steps 2 and 3.

2. Unscrew the strain relief from the connector-cable mounting assembly with the 19 mm open-end wrench or spanner.
3. Disconnect the connector-cable mounting assembly from the cable connection of the terminal with the 19 mm open-end wrench or spanner.
4. Remove the back cover as detailed on [page 23](#).
5. Disconnect the terminal connections at S2, S3, and S4. See [Figure 1](#) on [page 24](#) for their locations.
6. Gently pull the cable while you guide the three disconnected terminals out through the cable channel and cable connection.

IMPORTANT Do not force the disconnected terminals through the channel, or wires can be stripped from their connectors.

7. Follow [step 6](#) through [step 11](#) on [page 26](#) to complete the cable relocation.
8. Reinstall the plug with the 8 mm hex key in the cable connection from which the cable was removed.

Torque the plug to 1.2 N•m (10.6 lb•in.).

The 20-pin MobileView Connection Cable

The 20-pin connection cable connects a first generation MobileView 2711T terminal to an IP20 junction box. The connection cable is 5, 10, or 15 meters (16.4, 32.8, or 49.2 feet) long. This cable withstands water, cleaning agents, motor oil, drilling oils, grease, lubricants, and condensates that contain hydrochloric acid.



ATTENTION: For the IP20 junction box terminals (X1...X4) listed in the following table, see [Figure 3 on page 36](#).

S1 Cable Pin No.	Cable Wire Color	MobileView Terminal Main Circuit Board Connections			Signal Description	IP20 Junction Box	
		S2	S3	S4		Input (X4)	Output
1	pink	1			24V DC	1	X1, #1
2	black	2			GND_IN	2	X1, #2
3	brown	3			E-stop, circuit 2 (+)	5	X1, #5
4	white-green	4			E-stop, circuit 2 (-)	6	X1, #6
5	gray	5			E-stop, circuit 1 (+)	3	X1, #3
6	red-blue	6			E-stop, circuit 1 (-)	4	X1, #4
7	green-brown	7			Enabling switch, circuit 1 (+)	7	X1, #7
8	yellow	8			Enabling switch, circuit 1 (-)	8	X1, #8
9	green	9			Enabling switch, circuit 2 (+)	9	X1, #9
10	gray-pink	10			Enabling switch, circuit 2 (-)	10	X1, #10
11	—	11, 12			Not used	11	—
13	blue		1 ⁽¹⁾		TD+ (transmit)	13	X3, #1
14	white		2 ⁽¹⁾		TD- (transmit)	14	X3, #2
15	orange		3 ⁽¹⁾		RD+ (receive)	15	X3, #3
16	red		6 ⁽¹⁾		RD- (receive)	16	X3, #6
12	violet			1	External 1	12	X2, #1
17	white-pink			2	External 2	17	X2, #2
18	white			3	External 3	18	X2, #3
19	blue			4	External 4	19	X2, #4
20	white-blue			5	Not used	20	—

(1) Shielded.

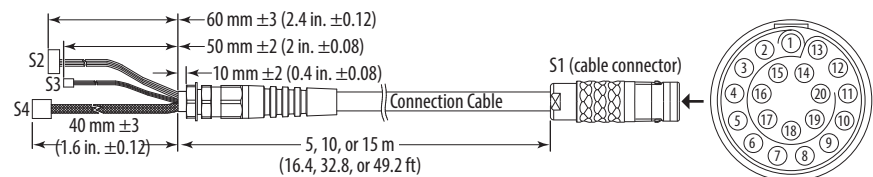

The 22-pin MobileView Connection Cable

The 22-pin connection cable connects a second generation MobileView 2711T terminal to an IP65 junction box. The connection cable is 5, 10, or 15 meters (16.4, 32.8, or 49.2 feet) long. This cable withstands water, cleaning agents, motor oil, drilling oils, grease, lubricants, and condensates that contain hydrochloric acid.

S1 Cable Pin No.	Cable Wire Color	MobileView Terminal Main Circuit Board Connections			Signal Description
		S2	S3	S4	
10	pink	1			24V DC
9	black	2			GND_IN
7	brown	3			E-stop, circuit 2 (+)
22	white-green	4			E-stop, circuit 2 (-)
6	gray	5			E-stop, circuit 1 (+)
19	red-blue	6			E-stop, circuit 1 (-)
18	green-brown	7			Enabling switch, circuit 1 (+)
20	yellow	8			Enabling switch, circuit 1 (-)
8	green	9			Enabling switch, circuit 2 (+)
21	gray-pink	10			Enabling switch, circuit 2 (-)
11	violet			2	E-stop, illuminated (+)
12	white-pink			4	E-stop, illuminated (-)
5	white			1	Semi-wireless jumper
14	blue			3	Semi-wireless jumper
13	white-blue			5	Box ID
15	Li1				Bridge
16	Li1				Bridge
17	—				Not used
1	blue		1 ⁽¹⁾		TD+ (transmit)
2	orange		2 ⁽¹⁾		TD- (transmit)
3	white		3 ⁽¹⁾		RD+ (receive)
4	red		6 ⁽¹⁾		RD- (receive)

(1) Shielded.

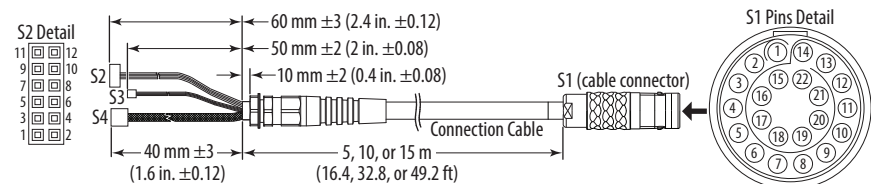

Adjust the Touch Screen



WARNING: If the LCD screen darkens or if the backlight is not functioning properly, the screen may be difficult to read and use of this screen could result in a potentially hazardous outcome. Do not use the LCD touch screen under these circumstances.

The design of the system must take into account the possibility of the LCD screen or LCD touch screen losing functionality and unable to be used to maintain or change control of the system. The touch screen shall not be the single point of control of critical functions and is not intended to replace an E-stop.

Design of the system should follow all applicable code and good engineering practice. Factors to consider include:

- The possibility of an unreadable LCD screen
- The possibility of an inoperable touch screen
- Unexpected communication errors or delays
- Operator error in the control of the system
- Proper use of E-stops and other safety practices

The user shall provide means to achieve a safe state during anomalies and to verify that the system has adequate redundancy for critical functions.

Failure to follow these instructions can result in death, serious injury, or equipment damage.

Adjust the Display Brightness

All MobileView 2711T terminals have an adjustable display-brightness setting that can be adjusted through the Power Options icon on the terminal desktop. The display-brightness default setting is 70%.

IMPORTANT Increasing the brightness from the default setting reduces the life of the LED backlight, particularly at high temperatures.

Recalibrate the Touch Screen

The touch screen is calibrated before shipment. You can recalibrate the touch screen. For more information, see [Touch Calibration on page 74](#).

Shut Down the MobileView 2711T Terminal

To shut down the MobileView 2711T terminal, perform the following steps.

IMPORTANT If you disabled EWF to make application changes, then you must enable EWF again before you shut down the MobileView 2711T terminal.

Review [Enhanced Write Filter \(EWF\) on page 57](#) before you shut down the MobileView 2711T terminal.

1. Close any open applications and return to the MobileView 2711T terminal desktop.
2. Tap  on the desktop task bar to shut down the MobileView 2711T terminal.
3. Tap OK on the shutdown confirmation dialog box.

The terminal shuts down.

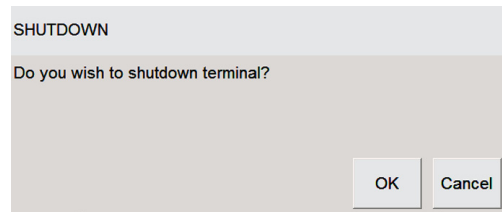

Disconnect Power from the MobileView 2711T Terminal

To disconnect power from the terminal, disconnect the tethered cable from the MobileView junction box.

IMPORTANT Do not disconnect the tethered cable from the junction box until you first shut down the MobileView 2711T terminal.

If you disconnect power from the terminal before you first shut it down, then you risk the following:

- You can corrupt the Windows operating system
- You lose application settings that were changed while the terminal was powered up
- You can corrupt any applications that were running, such as FTView ME

Install the Mounting Brackets

There are two mounting brackets available for MobileView terminals. Both brackets are an accessory, which means each one must be ordered separately from the MobileView 2711T terminal.

The MobileView 2711T-BRACKET mounting bracket is used for stationary operation or storage of the terminal. The mounting bracket ships with a cutout template, publication [2711T-DS001](#), for installation.

Use suitable flat-head screws (not shipped with product) to mount the bracket.

All dimensions are in mm (in.)

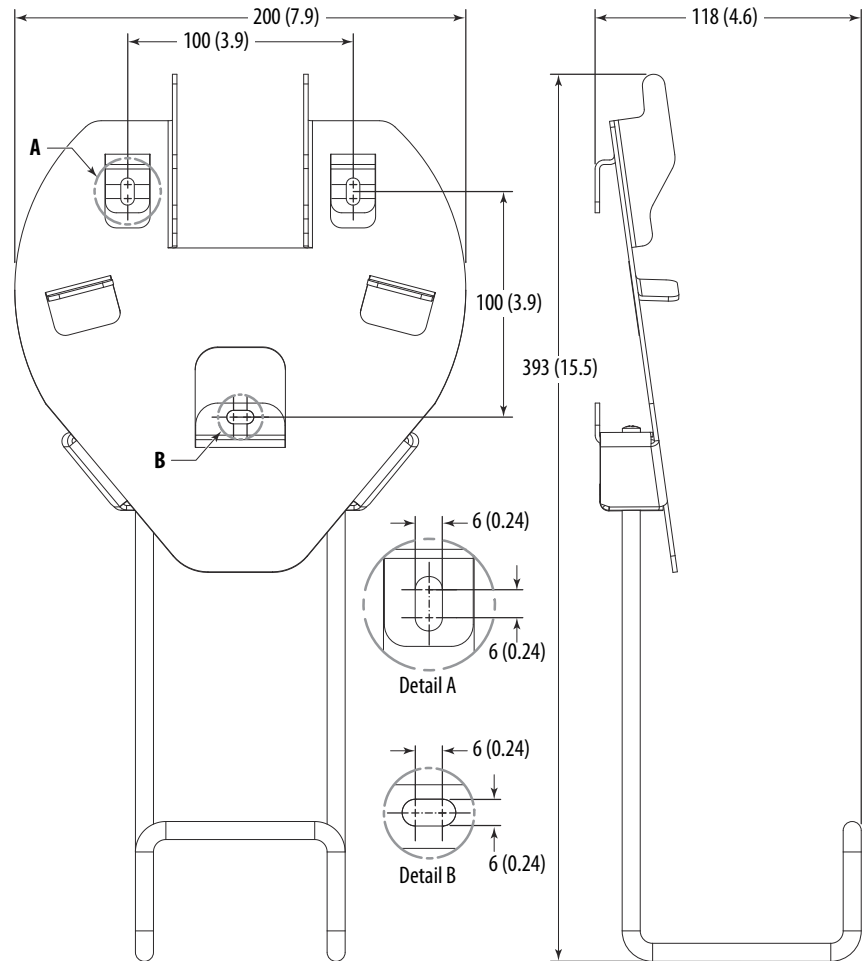

The MobileView 2711T-VMBRACKET VESA mounting bracket is used for stationary operation or storage of the terminal. The mounting bracket ships with a cutout template, publication [2711T-DS003](#), for installation.

You can lock the MobileView terminal in the VESA mounting bracket for security purposes.

TIP The lock handle turns when lifted for easier movement of its locking pin. When you use the lock handle, verify that it locks flush against the bracket surface. If not, lift and turn the lock handle slightly until it locks fully.

Use suitable flat-head screws (not shipped with product) to mount the bracket.

All dimensions are in mm (in.)

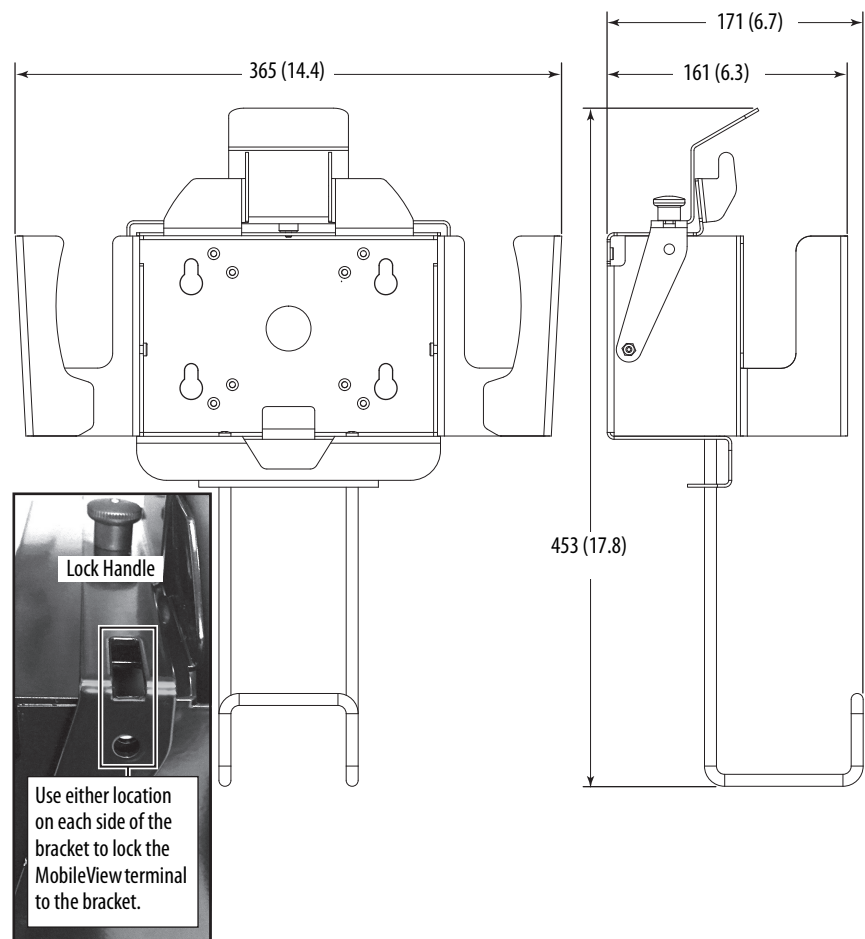

Notes:

Install and Operate the Junction Boxes

Topic	Page
Junction Box Overview	35
The MobileView IP20 Junction Box	36
The MobileView IP65 Junction Box	39

Junction Box Overview

There are three junction boxes available for MobileView™ terminals. There is one IP20-rated junction box, which can only work with first generation MobileView terminals, 20-pin connector cables, and the silver, 20-pin bridge connector. There are two IP65-rated junction boxes, both which work with select MobileView terminals⁽¹⁾, 22-pin connector cables, and the black, 22-pin bridge connector.



WARNING: You cannot use an IP65 junction box with 2711T-B10K1N1, 2711T-B10M1N1, or 2711T-T10R1N1 MobileView terminals, which are terminals with a key switch or a momentary push button.

An IP20 junction box must be installed inside a control cabinet. Both IP65 junction boxes can be installed outside a control cabinet. One IP65 junction box, 2711T-JBIP65DMI, provides On-Machine™ connectivity, where you can move the junction box closer to the application or on the machine, thus reducing the number of components in a control cabinet.



WARNING: Although IP65 junction box 2711T-JBIP65DMI provides On-Machine connectivity, do not install this junction box in an area or on a surface that is a hazardous location.

A second generation MobileView terminal can be connected and disconnected from an IP65 junction box for 10 seconds without opening the machine, equipment, or system-based E-stop circuits. A black, 22-pin bridge connector or another second generation MobileView terminal must be connected within 10 seconds, or the two junction box E-stop circuits are opened for safety reasons and an E-stop is triggered.

IMPORTANT The safety electronics of the E-stop bypassing of an IP65 junction box are designed with double circuits, and facilitates implementation up to Category 4, Performance Level e (CAT. 4, PLe) in accordance with EN ISO 13849-1 or SIL 3 in accordance with EN 61508.

(1) IP65 junction boxes work with 2711T-F10G1N1, 2711T-T10G1N1, 2711T-B10I1N1, and 2711T-T10I1N1-TC MobileView terminals.

The MobileView IP20 Junction Box

This section provides information on the following topics:

- [Mount and Connect the IP20 Junction Box](#)
- [Connect a First Generation MobileView Terminal to the IP20 Junction Box](#)
- [Connect to an Ethernet Network](#)

Mount and Connect the IP20 Junction Box

The MobileView IP20 junction box (2711T-JBIP20DC) connects a first generation MobileView 2711T terminal and 20-pin connection cable into a control system.

Figure 3 - IP20 Junction Box Dimensions and Connector Descriptions

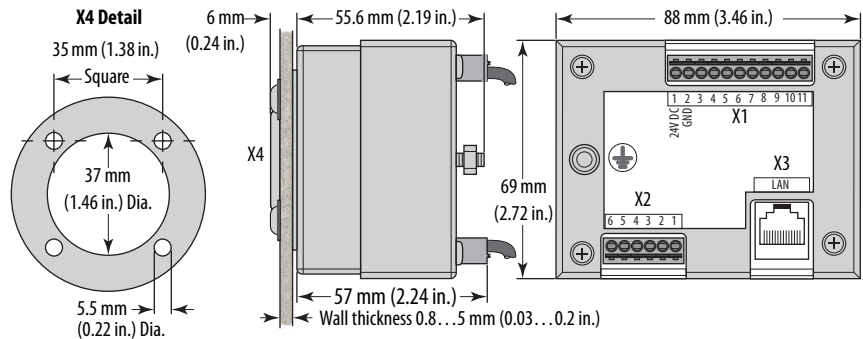

Connector	Description
X1	11-pin terminal for power, and safety circuits of E-stop push button and enabling switch of the first generation MobileView 2711T terminal.
X2	6-pin terminal for the optional push button or the optional key switch.
X3	LAN switch for Ethernet connectivity to a control system network.
X4	20-pin female connection for the MobileView connection cable; see page 28 for cable pinout details.



SHOCK HAZARD: Supply the junction box and terminal exclusively from power sources with SELV or PELV circuit protection according to EN 61131-2. Only connect voltages and circuits that are separated from dangerous voltages (for example, by means of sufficient insulation) to connections, terminals or interfaces up to a rated voltage of 50V DC.

Connect a First Generation MobileView Terminal to the IP20 Junction Box

To power up or start a first generation MobileView 2711T terminal, insert a 20-pin connection cable into the MobileView IP20 junction box.

[Figure 4](#) shows how a first generation MobileView 2711T terminal connects to the MobileView IP20 junction box.

Figure 4 - Typical Connection of a First Generation MobileView Terminal to an IP20 Junction Box

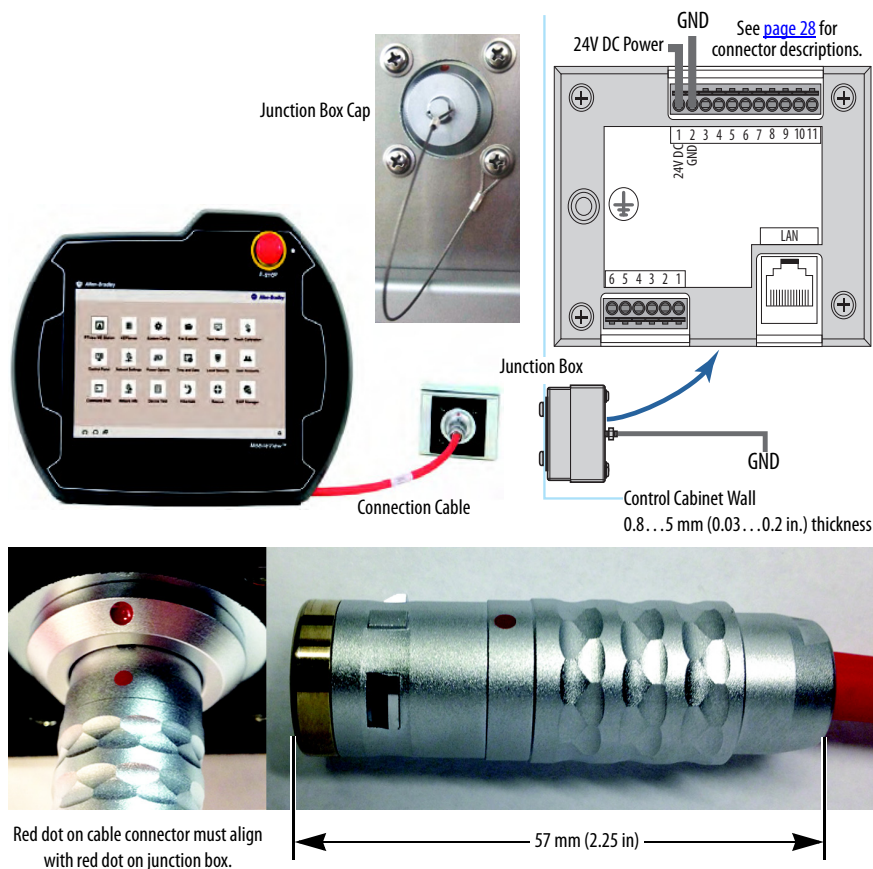

IMPORTANT A 20-pin connection cable has a silver cable connector, as shown above. A 22-pin connection cable has a black cable connector, as shown on [page 54](#). You cannot use a 20-pin connection cable with second generation MobileView terminals or either IP65 junction box. For what MobileView devices work with a 22-pin connection cable, see [page 54](#).

Junction Box Cap

A cap is provided to cover the IP20 junction box opening when the cable is not connected; see [Figure 4](#). The cap helps protect the opening and its pin connections from environmental elements.

Use one of the two bottom mounting screws of the junction box to attach the tethered cable of the cap to the control cabinet.

Figure 5 - IP20 Junction Box Pinout and Wiring

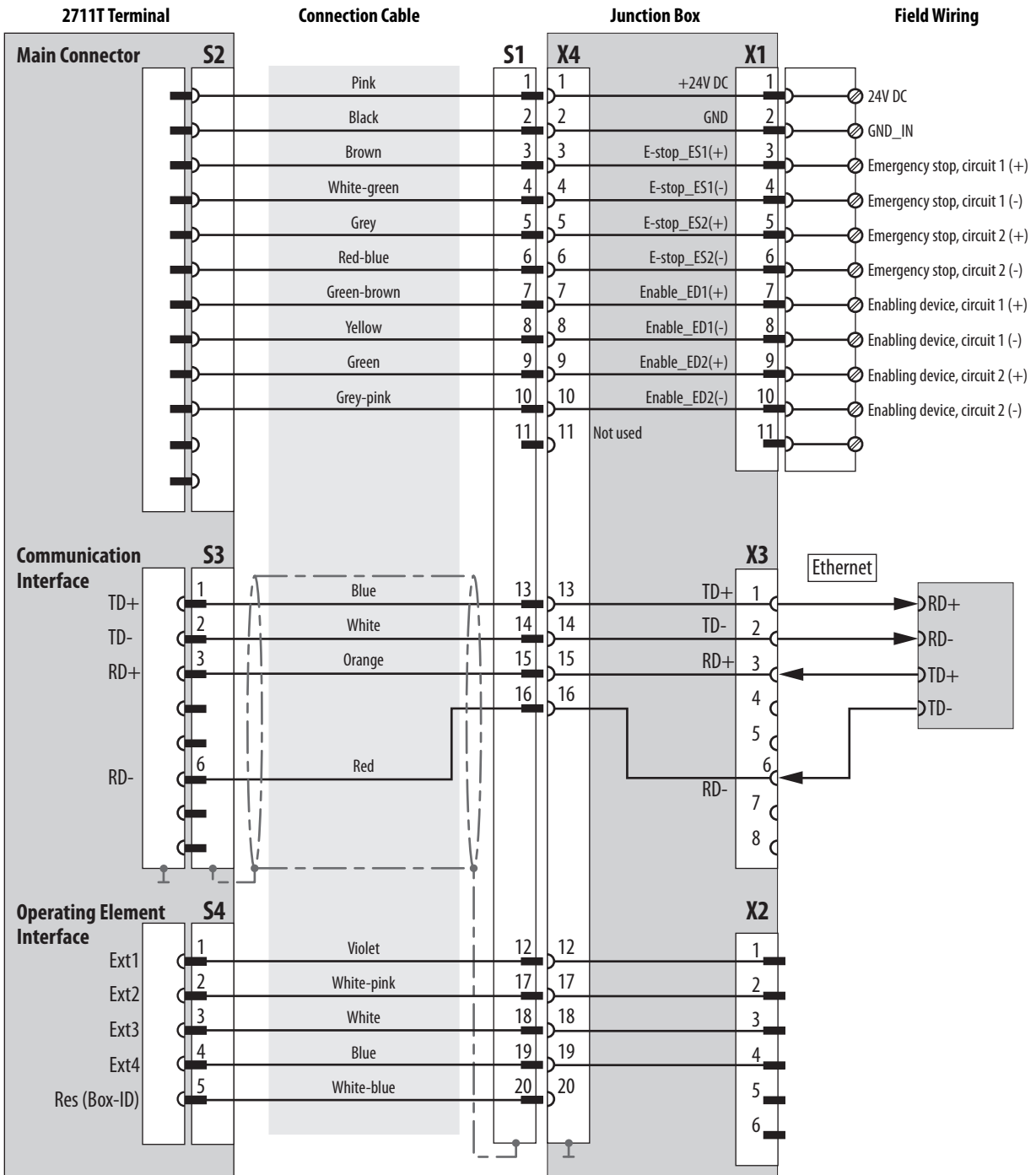

Electrical Specifications

24V DC power supply

- See [Table 13 on page 94](#) for the 24V DC power supply requirements.
- See [Power Supply on page 17](#) for additional information.

Connect to an Ethernet Network

First generation MobileView 2711T terminals are equipped with an Ethernet interface that supports TCP/IP protocol at 10/100 Mbps for half/full-duplex communication.



ATTENTION: Under high noise situations, the Ethernet network can have packet loss of <10% at 100Mbps. By design, Ethernet communication resends packets, so there is no data loss but there is a possible reduction in communication speed.

The Ethernet connector at X3 on the IP20 junction box provides a connection to an Ethernet network. The connector uses an 8-pin, RJ45 modular jack connector. Pinouts are as follows.

Table 4 - IP20 Junction Box Ethernet Pinouts (X3)

Pin #	Ethernet Signal	Pin #	Ethernet Signal
1	TD+	5	Not used
2	TD-	6	RD-
3	RD+	7	Not used
4	Not used	8	Not used

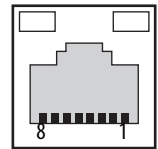

The MobileView IP65 Junction Box

There are two IP65 junction boxes that work with second generation MobileView terminals and 22-pin connection cables. 2711T-JBIP65DC1 is the IP65 junction box with cord grips that must be wired by the customer. 2711T-JBIP65DM1 is the IP65 junction box with M12 On-Machine connections that is factory-wired.



WARNING: You cannot use an IP65 junction box with 2711T-B10K1N1, 2711T-B10M1N1, or 2711T-T10R1N1 MobileView terminals, which are terminals with a key switch or a momentary push button.

This section provides information on the following topics:

- [Mount the IP65 Junction Box Back Plate](#)
- [Temporarily Mount the IP65 Junction Box](#)
- [Wire the 2711T-JBIP65DC1 Junction Box](#)
- [Configure the 2711T-JBIP65DC1 Junction Box](#)
- [Configure the 2711T-JBIP65DM1 Junction Box](#)
- [Mount the IP65 Junction Box to Its Back Plate](#)
- [Connect M12 On-Machine Connectors to the 2711T-JBIP65DM1 Junction Box](#)
- [IP65 Junction Box Status Lights](#)
- [Connect a Second Generation MobileView Terminal to an IP65 Junction Box](#)
- [Connect a Black Bridge Connector to an IP65 Junction Box](#)

Mount the IP65 Junction Box Back Plate

IP65 junction boxes are shipped with their back plate removed so you perform certain functions for each junction box as needed. This section provides information on how to mount the back plate of either IP65 junction box.

IP65 junction boxes are shipped with Second Generation MobileView Tethered Operator Terminal IP65 Junction Box Mounting Template, publication [2711T-DS004](#). Use this mounting template or the back plate of the IP65 junction box to drill the mounting holes.

IMPORTANT Consider the following before you mount an IP65 junction box:

- Do not mount near a heat source or where direct sunlight is likely.
- Do not mount where excessive mechanical vibrations, excessive dust, humidity, or strong magnetic fields are likely.

2711T-JBBKCOVER Back Cover Plate Accessory

This accessory is for rear access to the junction box from inside a control cabinet. This cover plate provides quick access to configurable components for both junction boxes (see [Figure 10 on page 46](#)), and to reduce cables that might otherwise be directed through cord grips on the 2711T-JBIP65DC1 junction box.

The cover plate is fitted with a seal. To maintain a tight seal and the IP65 rating (when installed on an IP65-rated control cabinet), install the cover plate on an even surface.

IMPORTANT Any cable fed through the control cabinet wall must be smaller than the hole in the cabinet wall.

Provide stress relief for the cables on the control cabinet side when you wire an IP65 junction box with this back cover plate.

Figure 6 - 2711T-JBBKCOVER Back Cover Plate Dimensions

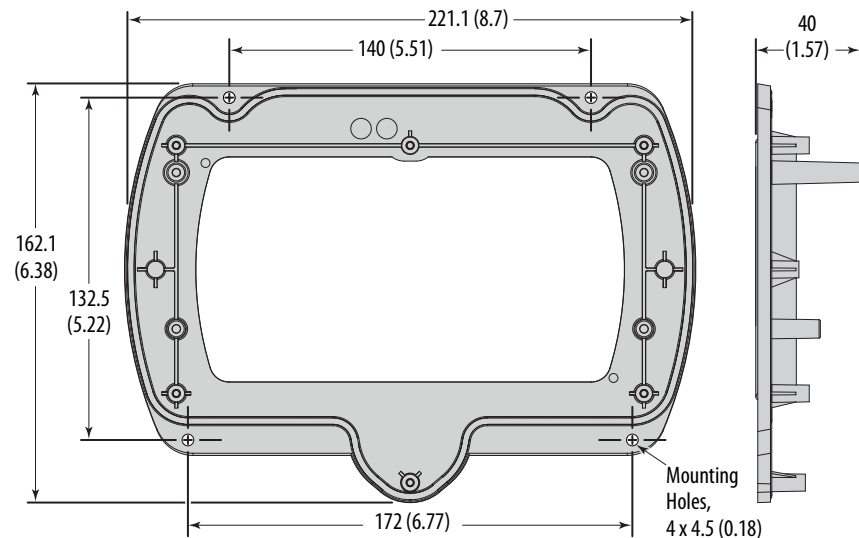

To mount the back plate of an IP65 junction box, perform the following steps.

IMPORTANT The following instructions also apply to the back cover plate accessory, cat. no. 2711T-JBBKCOVER.

1. Determine where to mount the junction box.

Use the dimensions in [Figure 6](#) or [Figure 7](#) to decide where to locate the junction box in a safe area that is easily accessible for a terminal operator.

Figure 7 - IP65 Junction Box Dimensions (for 2711T-JBIP65DC1 and 2711T-JBIP65DM1)

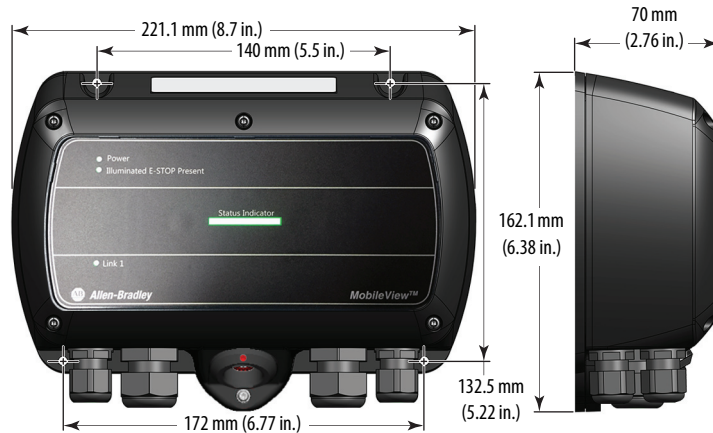

2. Use the back plate or the supplied cutout template to mark where to drill the four mounting holes for the junction box.

IMPORTANT Take precautions so metal cuttings do not enter components already installed in the control cabinet or in the junction box.

3. With a drill and drill bit, drill the four holes.

TIP Use four M4 bolts with a maximum bolt head diameter of 9 mm, and with self-locking M4 nuts.

However, the fasteners depend on the material of the mounting surface, such as the wall of a control cabinet or a machine.

4. Attach the back plate to the mounting surface.

Temporarily Mount the IP65 Junction Box

Temporarily mount an IP65 junction box to its installed back plate for the following:

- For hands-free wiring and subsequent configuring of 2711T-JBIP65DC1, the IP65 junction box with cord grips
- For Box ID configuring and brightness setting of 2711T-JBIP65DM1, the IP65 junction box with M12 On-Machine connections

You can slide the IP65 junction box onto the longer screw bosses of the mounted back plate; no screws are needed.

TIP The 2711T-JBBKCOVER back cover plate also has the longer screw bosses.

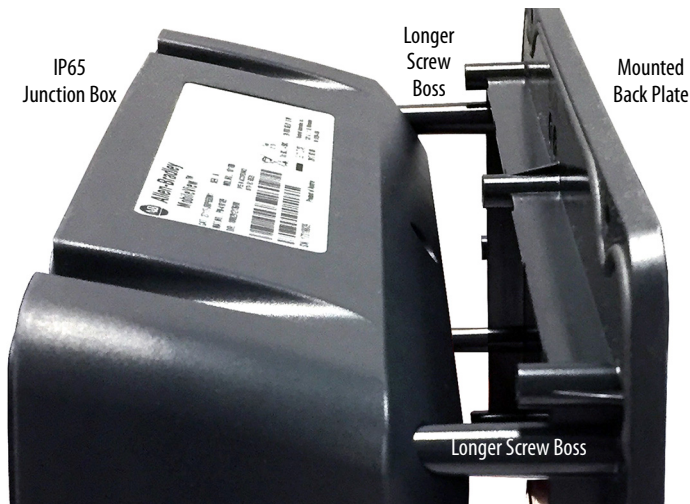

Wire the 2711T-JBIP65DC1 Junction Box

To wire the 2711T-JBIP65DC1 junction box, perform the following steps.



SHOCK HAZARD: When the back plate is removed, the circuit board inside the junction box is sensitive to ESD.

Use an anti-static wriststrap connected to the work surface, and properly grounded tools and equipment.

1. See [Figure 8 on page 43](#) to determine the appropriate cable outlets for the wires to be installed.
2. Remove the cable glands from the cable outlets at the bottom of the junction box that you plan to use.
3. With a small flat-head screwdriver, remove the black plugs from the seal rings that you plan to use.
4. Place the corresponding seal rings over each wire.
5. Place the corresponding cable gland over each wire.
6. Feed each wire through the corresponding cable outlet.
7. See [Figure 9 on page 44](#) to attach each wire to the appropriate terminal.
8. After all wires are attached, hand-tighten the cable glands to secure the wires.

IMPORTANT To maintain the protection class, any unused cable outlet must be sealed with a black plug.

Figure 8 - 2711T-JBIP65DC1 Junction Box Cable Outlets (with cover plate removed)

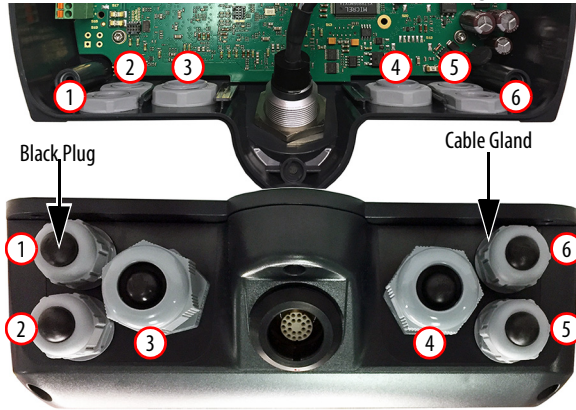

Table 5 - Cable Outlet Descriptions

Item No.	Cable Outlet Description	Gland Size	Cable Dia. Range	Protection Class
1	Standard	M16 x 1.5	4...10 mm (0.16...0.4 in.)	IP68
2	Standard			
3	Ethernet	M20 x 1.5	3...6 mm (0.12...0.24 in.)	IP66
4	Ethernet			
5	Standard	M16 x 1.5	4...10 mm (0.16...0.4 in.)	IP68
6	Standard			

- Before you reinstall the junction box to its back plate, consider how you plan to use the junction box with a second generation MobileView terminal.

If	Then
You plan to use a second generation MobileView terminal that does not have Box ID functionality	You must activate a DIP switch; see DIP Switch on page 46 .
You plan to use a second generation MobileView terminal with Box ID functionality with multiple IP65 junction boxes	You can assign an identification (ID) number for each junction box specific to its application; see Box ID Functionality on page 47 .
You want to adjust the brightness of the illuminated E-stop button on a second generation MobileView terminal	You can press an adjustment button for four possible brightness levels; see Illuminated E-stop Button Brightness on page 47 .

- After you perform any suggestions in [step 9](#), use a Torx 10 screwdriver and the six screws to reinstall the junction box to its cover plate.

Figure 9 - 2711T-JBIP65DC1 Junction Box Printed Circuit Board (PCB) Components

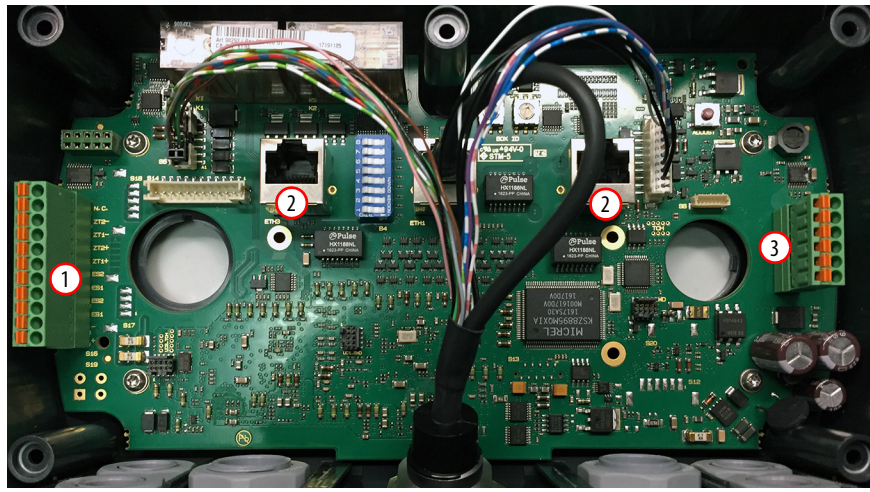

Item	PCB Description	Description
1	S16	11-pin terminal for power, and safety circuits of E-stop push button and enabling switch of the MobileView 2711T terminal. For more details, see S16 Terminal Pin Descriptions on page 44 .
2	ETH3, ETH2	8-pin, RJ45 terminal for Ethernet connectivity to a control system network. Use one terminal for input and the other terminal for output. For more details, Ethernet (ETH3, ETH2) Connections on page 45 .
3	S10	6-pin terminal for an application or control system where multiple IP65 junction boxes are used. This terminal helps identify which IP65 junction box has a second generation MobileView terminal attached to it. For more details, S10 Terminal Pin Descriptions on page 45 .

S16 Terminal Pin Descriptions

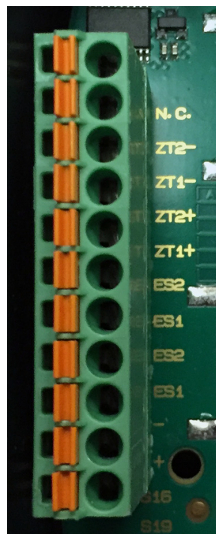

Pin No.	PCB Description	Description
1	N.C.	Not connected
2	ZT2-	Enabling device 2 safe input
3	ZT1-	Enabling device 1 safe input
4	ZT2+	Enabling device 2 test input
5	ZT1+	Enabling device 1 test input
6	ES2	One side of E-stop 2 relay (no polarity)
7	ES1	One side of E-stop 1 relay (no polarity)
8	ES2	One side of E-stop 2 relay (no polarity)
9	ES1	One side of E-stop 1 relay (no polarity)
10	-	Ground (GND) input
11	+	24V DC power supply

Electrical Specifications

24V DC power supply	<ul style="list-style-type: none"> See Table 10 on page 93 for the 24V DC power supply requirements. See Power Supply on page 17 for additional information.
---------------------	--

Ethernet (ETH3, ETH2) Connections

Second generation MobileView 2711T terminals are equipped with an Ethernet interface that supports TCP/IP protocol at 10/100 Mbps for half/full-duplex communication.



ATTENTION: Under high noise situations, the Ethernet network can have packet loss of <10% at 100Mbps. By design, Ethernet communication resends packets, so there is no data loss but there is a possible reduction in communication speed.

The two Ethernet connectors on the IP65 junction box provide connection to an Ethernet network. Each connector uses an 8-pin, RJ45 modular jack connector. Pinouts are as follows.

Pin #	Ethernet Signal
1	TD+
2	TD-
3	RD+
4	Not used

Pin #	Ethernet Signal
5	Not used
6	RD-
7	Not used
8	Not used

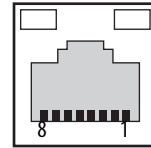

S10 Terminal Pin Descriptions

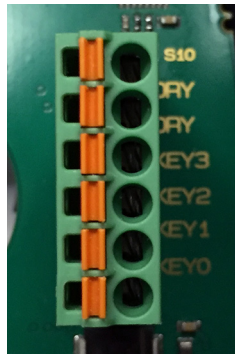

Pin No.	PCB Description	Description
1	DRY ⁽¹⁾	One side of dry contact relay (no polarity)
2	DRY ⁽¹⁾	One side of dry contact relay (no polarity)
3	KEY3	No connection
4	KEY2	
5	KEY1	
6	KEY0	

(1) Closed when a second generation MobileView terminal is connected. When an application or control system has multiple IP65 junction boxes available, this I/O is used to determine which junction box has a second generation MobileView terminal connected to it.

IMPORTANT The DRY contact signal can be used in the control application and is designed only for purposes that are not safety related.

Configure the 2711T-JBIP65DC1 Junction Box

The 2711T-JBIP65DC1 junction box can be configured to work with second generation MobileView terminals with Box ID functionality and illuminated E-stop buttons.

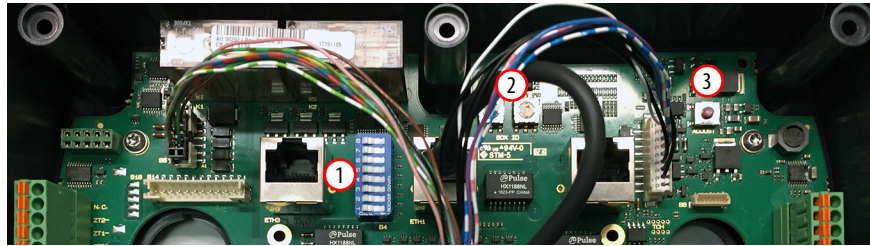
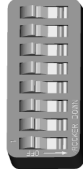

Figure 10 - IP65 Junction Box Configurable Components



Item	PCB Description	Description
1	B4	A DIP switch for MobileView terminals <u>without</u> Box ID functionality. Activate this DIP switch if the MobileView terminal has an illuminated E-stop button. For more details, see DIP Switch on page 46 .
2	BOX ID	Two hexadecimal rotary switches for MobileView terminals <u>with</u> Box ID functionality. Use these switches to set an identification (ID) number on an IP65 junction box. For more details, see Box ID Functionality on page 47 .
3	ADJUST	Use this switch to set the brightness of the illuminated E-stop button on a second generation MobileView terminal. For more details, see Illuminated E-stop Button Brightness on page 47 .

DIP Switch

If a MobileView terminal does not have Box ID functionality, then use this DIP switch to configure whether or not an illuminated E-stop button is used on the MobileView terminal.

If	Then
The MobileView terminal to be used has no Box ID functionality and no illuminated E-stop button (such as MobileView terminals with gray push buttons, cat. nos. 2711T-F10G1N1 and 2711T-T10G1N1)	All DIP switches must be deactivated (factory set as standard) 
The MobileView terminal to be used has no Box ID functionality but has an illuminated E-stop button	Activate DIP switch 8 

IMPORTANT If the MobileView terminal being used has Box ID functionality and an illuminated E-stop button, then no action is needed. The IP65 junction box automatically detects the illuminated E-stop button, and all factory set DIP switch settings remain deactivated.

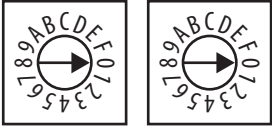

Box ID Functionality

If you have a second generation MobileView terminal with Box ID functionality, then you can set an ID number on an IP65 junction box. With an ID number, only settings specific to that application are available on the MobileView terminal, especially where one MobileView terminal with Box ID functionality is used between multiple IP65 junction boxes in various locations. Use the two hexadecimal rotary switches to set Box IDs from 0 to 255 as hexadecimal values.

To use Box ID functionality with FactoryTalk® View ME software, access the Rockwell Automation Knowledgebase link at <https://rockwellautomation.custhelp.com/> and search for AID 1043633.



ATTENTION: Instructions are included in AID 1043633 to first download ActiveX control for second generation MobileView terminals with firmware versions before 9.0.

ActiveX control is already included in MobileView firmware versions 9.0 or later.

Table 6 - Hexadecimal Rotary Switch Setting Examples

Left Switch Setting	Right Switch Setting	MobileView Terminal Number	Left Switch Setting	Right Switch Setting	MobileView Terminal Number	Left Switch Setting	Right Switch Setting	MobileView Terminal Number	Left Switch Setting	Right Switch Setting	MobileView Terminal Number
0	0	0 ⁽¹⁾	1	0	16	A	0	160	F	0	240
0	F	15	1	F	31	A	F	175	F	F	255

(1) Factory set as standard.

Illuminated E-stop Button Brightness

You can use a button on the IP65 junction box terminal to adjust the illuminated E-stop push button on a second generation MobileView terminal.



WARNING: To adjust the brightness, power must be applied to the IP65 junction box, and a second generation MobileView terminal must be connected to the junction box.

To avoid ESD damage to the junction box and to avoid electrical shock to the adjuster, only qualified personnel should perform this adjustment.

Available brightness levels are 95% (factory setting), 50%, 25%, and 12.5%. Each press of the button moves to the next brightness level. After you reach 12.5% brightness, the next press cycles back to 95%.

IMPORTANT Only adjust the brightness level of the illuminated E-stop button if it is appropriate for the environment where the second generation MobileView terminal is being used. Too low of a brightness setting can be difficult to see or can be misinterpreted.

The set brightness level is maintained, even after a power loss.

Configure the 2711T-JBIP65DM1 Junction Box

The 2711T-JBI65MI junction box with M12 On-Machine connections is factory-wired. It is still shipped with the back plate removed, so you can configure Box ID functionality or adjust the brightness of the illuminated push button on the MobileView terminal before you mount the junction box to its back plate and connect the M12 On-Machine connections.



SHOCK HAZARD: When the back plate is removed, the circuit board inside the 2711T-JBIP65DM1 junction box is sensitive to electrostatic discharge (ESD).

Use an anti-static wriststrap connected to the work surface, and properly grounded tools and equipment.

Box ID Functionality

See [Figure 10 on page 46](#) for where to find the Box ID address switches on the junction box circuit board.

See [page 47](#) for how to configure Box ID functionality for your 2711T-JBI65MI junction box.

Illuminated E-stop Button Brightness

See [Figure 10 on page 46](#) for where to find the illuminated E-stop button on the junction box circuit board.

See [page 47](#) for how to set the brightness of a second generation MobileView terminal meant to attach to your 2711T-JBI65MI junction box.

Mount the IP65 Junction Box to Its Back Plate

To mount an IP65 junction box to its back plate, perform the following steps.

1. If you temporarily mounted the IP65 junction box as detailed in [Temporarily Mount the IP65 Junction Box on page 41](#), remove the junction box from the screw bosses.
2. Align the IP65 junction box with its mounted back plate.



IMPORTANT To maintain a tight seal and the IP65 rating, verify that the junction box is seated properly to the cover plate.

3. Mount the junction box to its back plate with the six supplied screws. Torque the six screws to 0.85...1.15 N•m (7.5...10.2 lb•in).

Connect M12 On-Machine Connectors to the 2711T-JBIP65DM1 Junction Box

To connect M12 On-Machine connectors to the 2711T-JBIP65DM1 junction box, perform the following steps.

1. See [Figure 11](#) to determine where to connect each M12 On-Machine connection.

Figure 11 - 2711T-JBIP65DM1 Junction Box M12 On-Machine Connections

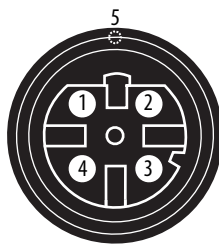

Table 7 - M12 On-Machine Connector Descriptions

Item No.	Connector Description	Connector Type ⁽¹⁾
1	Ethernet I/O	D-code pin female
2	Dry contact	5-pin micro-style male
3	Enabling device	5-pin I/O male
4	DC control power	Mini-DIN 4-pin male
5	E-stop	5-pin I/O male

(1) All connectors are M12 except for the Mini-DIN power connector.

M12 Ethernet Pin Descriptions



Pin No.	Description	Wire Color	8-way Modular RJ45 Pin
1	M12_Tx+	White-orange	1
2	M12_Rx+	White-green	3
3	M12_Tx-	Orange	2
4	M12_Tx-	Green	6
5	Connector shell shield GND		

For the D-code female network connectors, use polyamide small-body unshielded or zinc die-cast large-body shielded mating connectors.

If you use shielded (STP) cable with metal housing, isolate the shield at the junction box end of the cable to minimize ground offsets.

M12 Dry Contact, E-stop, and Enabling Device Pin Descriptions

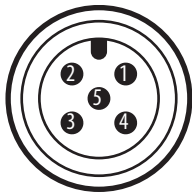

Pin No.	M12 Dry Contact Pin Descriptions
1	External 24V input
2	—
3	Ground (GND)
4	Dry contact output
5	—

Pin No.	M12 E-stop Pin Descriptions
1	E-stop 2 test output
2	E-stop 2 safe input
3	—
4	E-stop 1 safe input
5	E-stop 1 test output

Pin No.	M12 Enabling Device Pin Descriptions
1	Enabling device 2 test output
2	Enabling device 2 safe input
3	—
4	Enabling device 1 safe input
5	Enabling device 1 test output

Mini-DIN DC Power Pin Descriptions

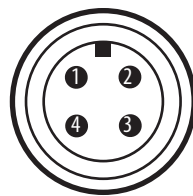

Pin No.	Description
1	Power –
2	—
3	Power +
4	—

Connect Power to IP65 Junction Boxes

After an IP65 junction box has been mounted, configured, and wired or connected, apply power to the junction box.

For information on 24V DC power supply requirements, see [Power Supply on page 17](#).



SHOCK HAZARD: Supply the IP65 junction box and the second generation MobileView terminal exclusively from power sources with SELV or PELV circuit protection according to EN 61131-2.

Only connect voltages and circuits that are separated from dangerous voltages (for example, by means of sufficient insulation) to connections, terminals or interfaces up to a rated voltage of 50V DC.

After power has been applied, perform the following steps to verify that the IP65 junction box is performing correctly.

IMPORTANT See [IP65 Junction Box Status Lights on page 52](#) or [Troubleshoot the IP65 Junction Box on page 90](#) for what the following colors represent.

1. Verify that the power status indicator on the front of the IP65 junction box is lit and green in color.
2. Verify that the Ethernet status indicator on the front of the IP65 junction box is lit and green in color.
3. Connect a second generation MobileView terminal.
 - a. If the MobileView terminal has an illuminated E-stop button, verify that the illuminated E-stop status indicator on the front of the IP65 junction box is lit and green in color.
 - b. Verify that the status indicator bar on the front of the IP65 junction box is lit and solid green in color.
4. Push the illuminated E-stop push button on the second generation MobileView terminal to trigger a stop.

Verify that the status indicator bar on the front of the IP65 junction box is lit and solid red in color.

5. Disconnect the MobileView terminal.

IMPORTANT When you disconnect a second generation MobileView terminal from an IP65 junction box, it begins a 10-second countdown to a system emergency stop. Therefore, you have 10 seconds to reconnect a second generation MobileView terminal or black bridge connector to keep the safety circuit complete.

- a. Verify that the status indicator bar on the front of the IP65 junction box changes from solid red to solid yellow.
- b. Verify that the status indicator bar reduces one blinking yellow light after each 1.67 seconds of disconnect time.

IMPORTANT Only perform step c if you are commissioning the unit, performing maintenance, or testing safety equipment, because step c triggers a system emergency stop.

- c. After 10 seconds of disconnect time, verify that all six lights of the status indicator bar are off and subsequently replaced by a blinking yellow status indicator bar.

The blinking yellow status indicates that the relay outputs of the IP65 junction box are de-energized and therefore open, which triggers an emergency stop of the system or machine.



WARNING: An IP65 junction box does not protect against the restart of a system or machine. Separate protection must be provided on the system or machine, such as an acknowledgment key.

IP65 Junction Box Status Lights

The front of each IP65 junction box has three status indicators and a status indicator bar.



[Table 8](#) explains what each color signifies on the lights and status indicator bar.

Table 8 - IP65 Junction Box Status Indicators and Bar Colors

Indicator	Color Displayed	Status Indicated
Power	Green	Power is present and the IP65 junction box is ready for operation.
	No color	No power is present or there is a fault during startup.
Illuminated E-stop	Green	A second generation MobileView terminal with an illuminated E-stop button is connected to the junction box.
	No color	A second generation MobileView terminal without an illuminated E-stop button is connected to the junction box.
Ethernet	Green	The junction box is connected to an Ethernet network.
	No color	The junction box is not connected to an Ethernet network.
Status indicator bar ⁽¹⁾	Solid green	A second generation MobileView terminal with an E-stop button is connected correctly and the E-stop has not been pressed.
	Solid white	No second generation MobileView terminal is connected but a 22-pin bridge connector is connected correctly.
	Blinking white	No second generation MobileView terminal or 22-pin bridge connector is connected to the junction box.
	Solid yellow	Begins the disconnect count time of 10 seconds after a second generation MobileView terminal or 22-pin bridge connector is disconnected from the junction box.
	Partial yellow	Going from right to left, a light on the status bar shuts off after 1.67 seconds of disconnect time has passed. For example, only three of the six lights remain lit after five seconds of disconnect time.
	Blinking yellow	When no plug is connected after 10 seconds, the disconnect timeout forces the junction box into a safe mode.
	Solid red	An E-stop button on a second generation MobileView terminal has been pressed and safe mode is activated.

(1) The IP65 junction box must have power (green at power status indicator) for the status bar to display status.



ATTENTION: Other colors signify when a second generation MobileView terminal or IP65 junction box are in an error state. To identify these colors, see [Troubleshoot the IP65 Junction Box on page 90](#).

Reconnect Power to IP65 Junction Boxes

If the IP65 junction box is powered off, the relays of the emergency stop circuits are no longer actively held closed and the emergency stop circuit is subsequently opened, which is comparable to an activated E-stop.

When powered off, the input states and E-stop state at that time are saved in the IP65 junction box memory. When power is restored, these saved states are subsequently retrieved.

Therefore, the IP65 junction box can have the following states.

State	Description
Normal	A second generation MobileView terminal (with an unactivated E-stop push button) is connected.
Bride active	A black, 22-pin bridge connector is connected.
E-stop	The E-stop push button on the second generation MobileView terminal has been activated.
Error state	The E-stop push button on the connected, second generation MobileView terminal and the retrieved E-stop in the IP65 junction box memory are not the same. In this case, the E-stop push button of the connected MobileView terminal is unactivated but the saved, retained E-stop in the IP65 junction box memory is activated. Therefore, the E-stop push button on the MobileView terminal must be activated and then unlocked to reset the IP65 junction box.

Connected/Disconnected Timer State

A second generation MobileView terminal or a black bridge connector must be connected to the IP65 junction box. When you disconnect one to connect the other, the IP65 junction box recognizes the disconnection and enters a timer state, when the operator has a maximum of 10 seconds to reconnect a device.

During this disconnected time, the E-stop of the IP65 junction box is bypassed until a MobileView terminal with an unactivated E-stop push button or a black bridge connector is connected.

If	Then
The connected, second generation MobileView terminal has an illuminated E-stop push button that is unactivated ⁽¹⁾	The E-stop push button is recognized by the IP65 junction box and it is illuminated.
The connected, second generation MobileView terminal has an illuminated E-stop push button that is properly configured but activated	The E-stop push button on the second generation MobileView terminal must be deactivated and reset before the IP65 junction box returns to the normal state mentioned in Reconnect Power to IP65 Junction Boxes .
A black bridge connector is being connected	The black bridge connector must be connected within 10 seconds for the IP65 junction box to recognize the device and enter the bridge active state mentioned in Reconnect Power to IP65 Junction Boxes .
No second generation MobileView terminal or black bridge connector is connected within 10 seconds	The IP65 junction box timer state times out and an E-stop is triggered.

(1) You must first configure an IP65 junction box to recognize an illuminated E-stop push button on a second generation MobileView terminal. For more information, see [DIP Switch on page 46](#).

Connect a Second Generation MobileView Terminal to an IP65 Junction Box

To power up or start a second generation MobileView 2711T terminal, insert a 22-pin connection cable into the MobileView IP65 junction box. A 22-pin connection cable has a black cable connector.



IMPORTANT

You can use a 22-pin connection cable with all second generation MobileView terminals, first generation MobileView terminals 2711T-F10G1N1 and 2711T-T10G1N1, and both IP65 junction boxes.

You cannot use a 22-pin connection cable with first generation MobileView terminals 2711T-B10K1N1, 2711T-B10M1N1, and 2711T-T10R1N1, or an IP20 junction box.

Connect a Black Bridge Connector to an IP65 Junction Box

An optional black, 22-pin bridge connector (cat. no. 2711T-22JUMP) is available for the IP65 junction box. It is for situations when the IP65 junction box is powered on but a second generation MobileView terminal is not connected to the junction box.

In these situations, the black bridge connector is connected so the IP65 junction box is placed in a bridge active state and its E-stop circuits are bypassed.

The black bridge connector includes a tethered cable so it can be secured with one of the bottom screws of an IP65 junction box. For more information on the bottom screws, see [Mount the IP65 Junction Box to Its Back Plate on page 48](#).

Set Up the BIOS Settings and Desktop Icons

Topic	Page
End User Setup Procedure	55
Desktop Overview	56
Enhanced Write Filter (EWF)	57
FTView ME Station	58
KEP Server Enterprise	67
VNC Server	67
System Config	69
Network Settings	72
Remote Desktop	73
Touch Calibration	74
Rescue	75
Restore the Default BIOS	75
Change the BIOS Password	77
Back Up the Operating System Image	80
Restore the Operating System Image	83

End User Setup Procedure

When a MobileView™ 2711T terminal is powered up for the first time, there are several set-up messages that appear as part of the Microsoft Windows End User Setup procedure.

If your MobileView 2711T terminal must be reformatted, then see 'Initial Configuration of the Windows Operating System' in publication [2711T-QS001](#), MobileView Tethered Operator Terminal Quick Start (for first generation MobileView terminals) or [2711T-QS002](#), Second Generation MobileView Terminal Quick Start, for this set-up procedure.

IMPORTANT Do not disconnect power from a MobileView 2711T terminal until after the Windows End User Setup procedure is completed.

If power is disconnected during this procedure, it can result in a corrupted system image.

Desktop Overview



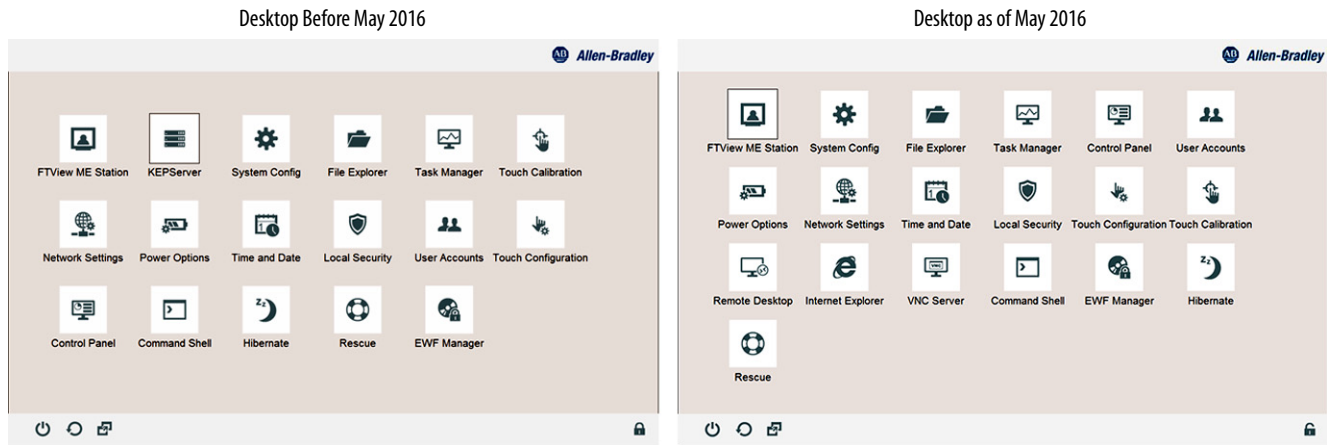

The desktop is the main graphical interface of the MobileView 2711T terminal. Each desktop icon provides access to information or configurable options.



Button	Description
FTView ME Station	Use to access, configure, and run FactoryTalk® View Machine Edition software. For more information, see page 58 .
KEP Server (before May 2016)	Use to access, configure, and run KEPServer Enterprise software. For more information, see page 67 .
VNC Server (as of May 2016)	Use to activate/deactivate and configure VNC Server software. For more information, see page 67 .
System Config	Use to update the BIOS or firmware of the MobileView 2711T terminal. For more information, see page 69 .
File Explorer	Use to browse the MobileView 2711T terminal file system and storage devices.
Task Manager	Use to manage running applications and services on the MobileView 2711T terminal. Can be beneficial for troubleshooting.
Touch Calibration	Use to calibrate the MobileView 2711T touch screen. For more information, see page 74 .
Network Settings	Use to configure and establish network communication. For more information, see page 72 .
Power Options	Use to adjust the MobileView 2711T terminal power plan, such as display brightness and sleep options.
Time and Date	Use to adjust the MobileView 2711T terminal system clock.
Local Security	Use to configure the MobileView 2711T terminal local security policy. Use only for advanced security configuration.
User Accounts	Use to manage Windows user accounts within the MobileView 2711T terminal operating system.
Touch Configuration	Use to manage touch options, such as double-tap and right-click. For more information, see page 63 .
Control Panel	Use to adjust the MobileView 2711T terminal operating system settings, such as system security, network, and hardware configuration.
Remote Desktop (as of May 2016)	Use to connect to another device, such as a personal computer or another HMI device. For more information, see page 73 .
Internet Explorer (as of May 2016)	Use to access the Internet after you have configured your network settings. For network settings, see page 72 .
Command Shell	Use for MobileView 2711T terminal advanced setup and configuration functions. Can be beneficial for troubleshooting.
Hibernate	Use to temporarily suspend power to the MobileView 2711T terminal without any data or state loss risk.
Rescue	Use to rescue the MobileView 2711T terminal when it gets 'stuck' in an application loop. For more information, see page 75 .
EWF Manager	Use to enable or disable Enhanced Write Filter (EWF). For more information, see page 57 .

Buttons on the Task Bar

The icons on the terminal-desktop task bar serve the following functions.

Button	Description
	Tap to power down the MobileView 2711T terminal.
	Tap to reboot (restart) the MobileView 2711T terminal.
	Tap to toggle between open tasks and applications on the MobileView 2711T terminal (similar to Alt+Tab on a keyboard).
	Status indicator for Enhanced Write Filter (EWF). Closed lock signifies EWF is enabled and open lock signifies EWF is disabled.

Enhanced Write Filter (EWF)

The Enhanced Write Filter (EWF) is a feature within the operating system of the MobileView 2711T terminal. When EWF is enabled, the system volume within the operating system is write-protected, which provides an additional level of robustness for the operating system.

Before you configure applications on the MobileView 2711T terminal, verify that EWF is disabled. On the terminal-desktop task bar, the EWF status icon is unlocked  when EWF is disabled.

IMPORTANT

By default, EWF is disabled. EWF must be disabled or any application changes are lost when the MobileView 2711T terminal is powered down.



Rockwell Automation recommends that you enable EWF to preserve operating system and application integrity, especially for where the terminal is expected to be frequently connected and disconnected from junction boxes.

Rockwell Automation recommends that you only enable EWF after applications on the MobileView 2711T terminal such as FactoryTalk View Machine Edition (ME) have been set up.

EWF applies only to the internal storage drive (C:) of the MobileView 2711T terminal and not to the internal SD card drive (D:).

To **enable EWF**, perform the following steps.

1. On the terminal-desktop task bar, verify that the EWF is unlocked.

EWF is enabled if the status icon is locked ; EWF is disabled if the status icon is unlocked . By default, EWF is disabled.

2. On the MobileView 2711T terminal desktop, tap the EWF Manager.



3. The following screen appears. Tap OK.

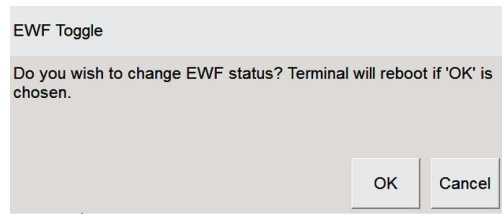

If you change the EWF status, then the MobileView 2711T terminal automatically restarts.

4. When the terminal desktop reappears, the EWF status icon on the terminal-desktop task bar is locked  to signify EWF is enabled.

IMPORTANT Rockwell Automation recommends that you only enable EWF after applications on the MobileView 2711T terminal such as FactoryTalk View Machine Edition (ME) have been set up.

If you make application changes with EWF enabled, then those changes are lost when the MobileView 2711T terminal is powered down or rebooted.

FTView ME Station

FactoryTalk View Machine Edition (ME) Station software on your MobileView 2711T terminal is dependent on a runtime application (MER) file that is configured on a separate personal computer with FactoryTalk® View Studio software installed.



ATTENTION: For MobileView 2711T terminals bought before May 2016, you must transfer the MER file with a USB storage device.

For MobileView 2711T terminals bought as of May 2016, you can transfer the MER file through the Ethernet network.

For MobileView 2711T terminals bought before May 2016, a fix is available for the FactoryTalk View ME Station software so you can download MER files through the Ethernet network instead of a USB storage device. For more information, see [FactoryTalk View ME Station Software Patch on page 64](#).

Transfer the MER File With a USB Storage Device

The following section applies to MobileView terminals purchased before May 2016, which use a USB storage device to transfer the runtime application (MER) file between your personal computer and the MobileView terminal.

To initially configure FactoryTalk View ME Station, perform the following steps.

IMPORTANT EWF must disabled before you configure FTView ME settings, and then enabled afterwards. For more information, see [Enhanced Write Filter \(EWF\) on page 57](#).

1. Create a MER file with FactoryTalk View Studio software on your personal computer.
2. Copy this file to a USB storage device.



ATTENTION: You cannot use the FactoryTalk View ME transfer utility to transfer the MER file from the personal computer to the MobileView 2711T terminal.

3. Insert the USB storage device into the USB port on the back of the MobileView 2711T terminal.
4. On the MobileView 2711T terminal desktop, tap File Explorer.

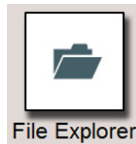

5. Browse to find the USB storage device.
6. Touch and hold for about 3 seconds, and then release.
A pull-down menu appears.
7. Tap Copy.
8. Browse to find the internal 'SD-CARD (D:)' drive of the MobileView 2711T terminal.
9. Touch and hold for about 3 seconds, and then release.
A pull-down menu appears.
10. Tap Paste.
The runtime application file (.MER) needed for FTView ME Station now resides on the internal SD card drive.
11. Close File Explorer.
12. On the MobileView 2711T terminal desktop, tap FTView ME Station.

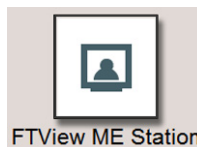

This dialog appears.

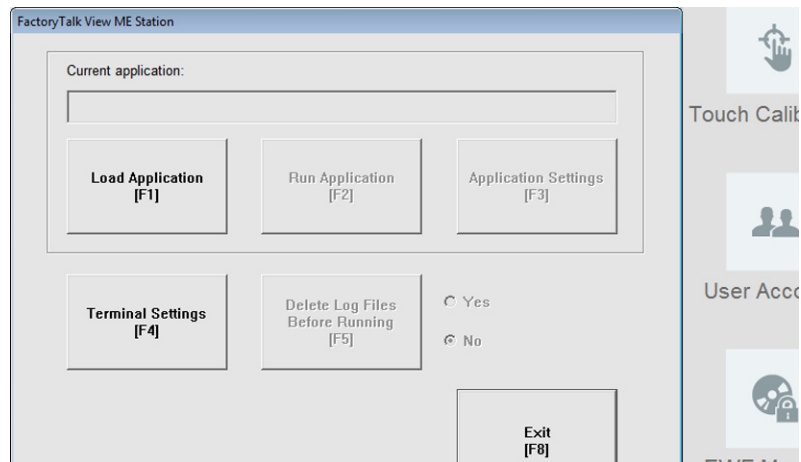

13. Tap Load Application or F1 to load the MER file.
14. Browse to the internal SD card drive (D:) and tap the MER file that you wish to load.
15. Tap Open.
You are prompted if you wish to replace the current communication configuration of the terminal with the communication configuration of the application.
16. Depending on your application, tap Yes or No.
Wait while the application loads.
17. Tap Terminal Settings or F4 to configure FactoryTalk ME Station-specific settings (for example, for FactoryTalk View ME Station to automatically start on a MobileView terminal power up or reboot).
18. If desired, tap Application Settings or F3 to configure FactoryTalk View ME Station application-specific settings (for example, device shortcuts or start-up language).
19. Tap the MobileView terminal-desktop to access EWF Manager and enable EWF; see [page 57](#) for how to enable EWF.

IMPORTANT Do not tap the Exit button (F8) in FactoryTalk View ME Station before you access EWF Manager on the MobileView terminal-desktop.

After you enable EWF, the MobileView 2711T terminal automatically restarts.

20. If FactoryTalk View ME Station was configured in [step 17](#) to automatically start after any MobileView terminal startup or reboot, then the application automatically starts after [step 19](#).

If FactoryTalk was not configured to automatically start, then you must tap the FactoryTalk View ME Station icon on the MobileView terminal-desktop to load and run the application.

Transfer the MER File Through the Ethernet Network

The following section applies to MobileView terminals purchased since May 2016, which use the Ethernet network to transfer the runtime application (MER) file between your personal computer and the MobileView terminal.

To initially configure FactoryTalk View ME Station, perform the following steps.

IMPORTANT EWF must be disabled before you configure FTView ME settings, and then enabled afterwards. For more information, see [Enhanced Write Filter \(EWF\) on page 57](#).

1. Create a MER file with FactoryTalk View Studio software on your personal computer.
2. Within FactoryTalk View Studio software, launch the transfer utility.
3. On the Download tab of the transfer utility dialog box, select the following:
 - The MER file that you just created on your personal computer as the source file (A).
 - The destination storage type as External Storage 1 (B).
This selection places the MER file on the SD card of your MobileView terminal.
 - Select your MobileView terminal as the destination terminal (C).
 - Click Download (D).

TIP See the graphic with [step 6 on page 62](#) for where the MER file resides on the SD card.

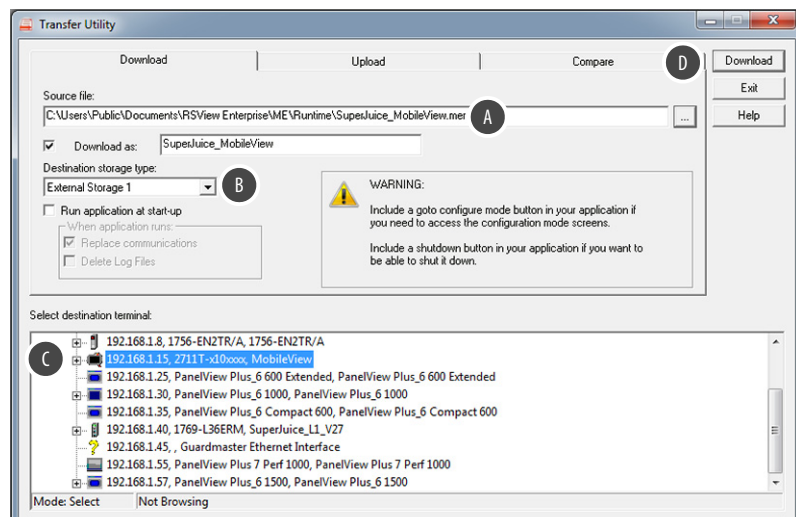

4. On the MobileView 2711T terminal-desktop, tap FTView ME Station.

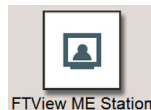

The following dialog appears.

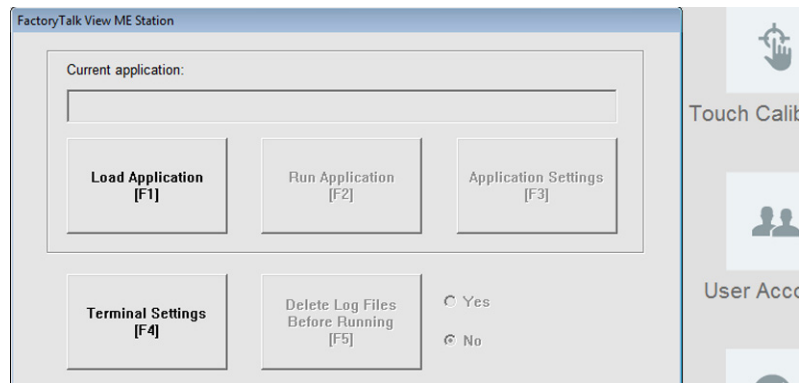

5. Tap Load Application or F1 to load the MER file.
6. Browse to the internal SD card drive (D:) and tap the MER file that you wish to load.

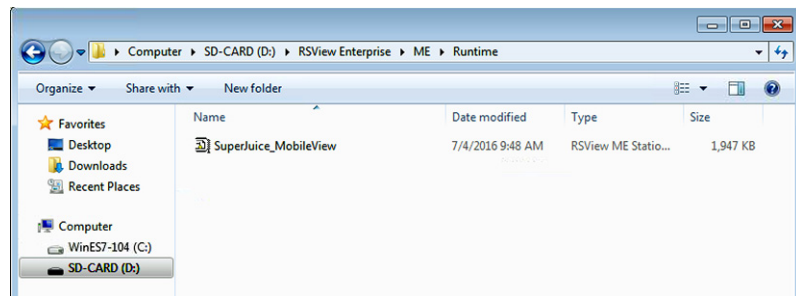

7. Tap Open.

You are prompted if you wish to replace the current communication configuration of the terminal with the communication configuration of the application.
8. Depending on your application, tap Yes or No.

Wait while the application loads.
9. Tap Terminal Settings or F4 to configure FactoryTalk ME Station-specific settings (for example, for FactoryTalk View ME Station to automatically start on a MobileView 2711T terminal power up or reboot).
10. If desired, tap Application Settings or F3 to configure FactoryTalk View ME Station application-specific settings (for example, device shortcuts or start-up language).
11. Tap the MobileView terminal-desktop to access EWF Manager and enable EWF; see [page 57](#) for how to enable EWF.

IMPORTANT Do not tap the Exit button (F8) in FactoryTalk View ME Station before you access EWF Manager on the MobileView terminal-desktop.

After you enable EWF, the MobileView 2711T terminal automatically restarts.

- If FactoryTalk View ME Station was configured in [step 9](#) to automatically start after any MobileView 2711T terminal startup or reboot, then the application automatically starts after [step 11](#).

If FactoryTalk was not configured to automatically start, then you must tap the FactoryTalk View ME Station icon on the MobileView terminal-desktop to load and run the application.

Right-click Touch Screen Functionality and FactoryTalk View ME Station

If your FactoryTalk View ME Station software uses momentary push buttons and you require long press times to activate those buttons, then the right-click touch screen functionality within the MobileView operating system must be disabled. By default, right-click functionality is enabled for the touch screen.

IMPORTANT EWF must be disabled before you change right-click functionality, and then enabled afterwards. For more information, see [Enhanced Write Filter \(EWF\) on page 57](#).

To disable right-click touch screen functionality, perform the following steps.

- From the MobileView 2711T terminal desktop, tap Touch Configuration.



- On the Touch tab of the Pen and Touch dialog box, tap Press and hold.

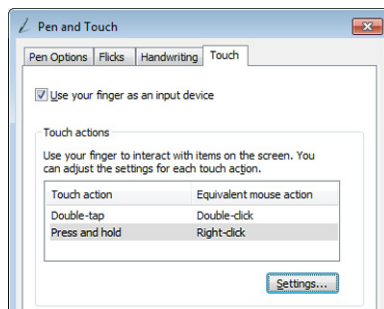

With Press and hold highlighted, tap Settings.

- Deselect the Enable press and hold for right-clicking box.

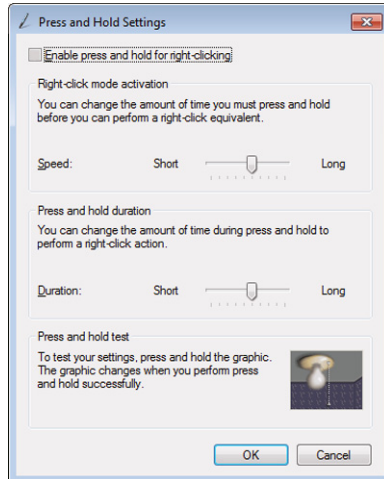

Tap OK.

4. On the Touch tab, tap Apply.

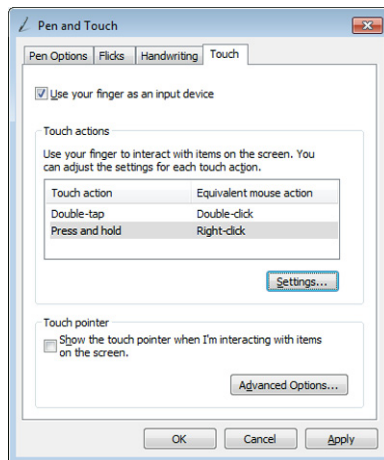

Right-click functionality for the touch screen is now disabled.

5. Enable EWF to save your settings. For more information, see [Enhanced Write Filter \(EWF\) on page 57](#).

FactoryTalk View ME Station Software Patch

For MobileView 2711T terminals bought before May 2016, a patch is available for the FactoryTalk View ME Station software so you can download MER files through the Ethernet network instead of a USB storage device. There are two ways to download this patch; as a patch or as an updated system image.

IMPORTANT The system image includes the patch but updates only the MobileView 2711T terminal. To update the FactoryTalk View Studio ME software (versions 8.00 or 8.10) on your personal computer, you must apply the patch.

Download the Patch

1. From your personal computer with FactoryTalk View Studio software, access the Rockwell Automation Knowledgebase:

<https://rockwellautomation.custhelp.com/>

2. Log in with your Knowledgebase credentials.
3. In the search field, type 732010

ch Knowledgebase

What Do You Need Help With?

Refine search by: Product Error code Answer ID

732010 

[Search Tips](#)

Need Help Another Way?

Knowledgebase
Detailed answers to your questions.

Submit a Question
When you don't need an answer right away.

RESULTS Sort by: 

Patch: Support for MobileView terminal, FactoryTalk View 8.0/8.1, FactoryTalk Services 2.71/2.74/2.80, RSLinx Enterprise 5.71/5.74/5.80, AssetCentre 6.10

732010 | Access Level: Everyone | Date Created: 10/09/2015 | Last Updated: 02/24/2016

Solution This patch adds support for the MobileView terminal. The setup needs to be run on both the desktop and the MobileView terminal. The patch applies to the following products: FactoryTalk...

4. Follow the instructions on the site to download the patch to your personal computer.

IMPORTANT If you have FactoryTalk View Studio ME software versions 8.00 or 8.10, then you must also run the patch on your personal computer.

5. Copy the patch to an attached USB storage device.
6. Insert the USB storage device into the USB port on the back of the MobileView 2711T terminal.
7. On the MobileView 2711T terminal desktop, tap File Explorer.

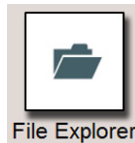

8. Browse to find the USB storage device.
9. Select and run the patch file.

TIP The patch searches and verifies if the FactoryTalk View ME Station version on your MobileView terminal requires the update.

10. After the patch is applied, you must reboot the MobileView 2711T terminal.

Afterwards, you can use the FactoryTalk ME transfer utility to transfer a MER file from your personal computer to the MobileView 2711T terminal through the Ethernet network.

Download the System Image

1. From your personal computer with FactoryTalk View ME Station software, access the Rockwell Automation Product Compatibility and Download Center (PCDC):
<http://www.rockwellautomation.com/global/support/pcdc.page>
2. Under Download, click Find Downloads.
3. In the Product Search field, use MobileView as your search criteria.
4. Select your MobileView 2711T terminal model.
5. Under the corresponding Selections tab, click Downloads.
6. Under the Downloads column, click  or check Select Files.
7. Select the accessory file for the version of your FactoryTalk View ME Station software.
8. Click Download Cart and then Download Now.
9. Follow the instructions on the site to download the system image to your personal computer.
10. Copy the system image to the '\images' folder on an attached USB storage drive.
11. Insert the USB storage device into the USB port on the back of the MobileView 2711T terminal.
12. To apply the system image, follow the steps in [Restore the Operating System Image on page 83](#).

IMPORTANT This updated system image does not update the FactoryTalk View Studio ME software on your personal computer. To update your personal computer, see [Download the Patch on page 65](#).

KEPServer Enterprise

KEPServer Enterprise is a flexible and scalable solution that is designed for quick and easy configuration of your communications. Use this application to configure communication with third-party hardware devices.

IMPORTANT KEPServer Enterprise requires a license that can be purchased at <https://www.kepware.com/en-us/products/kepserverex/suites/allen-bradley-suite/>.

KEPServer Enterprise is an application only for administrators. For more information on how to configure KEPServer Enterprise, see publication [VIEWME-UM004](#), FactoryTalk View Machine Edition User's Guide.

You must disable EWF before you configure KEPServer settings, and then enable EWF again afterwards. For more information, see [Enhanced Write Filter \(EWF\) on page 57](#).

To launch KEPServer Enterprise on MobileView 2711T terminals before May 2016, perform the following steps.

1. On the MobileView 2711T terminal desktop, tap KEPServer.

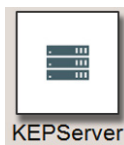

2. Use KEPServer Enterprise to configure your communication channels.

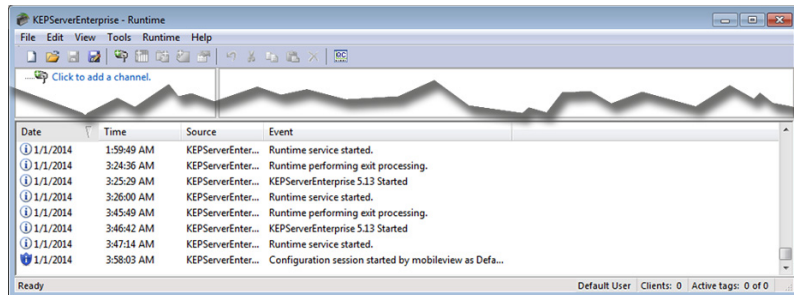

VNC Server

VNC Server is a graphical desktop sharing system used to remotely control another computer. It transmits keyboard/mouse events from one computer to another, over a network.

IMPORTANT VNC Server is an application available only on MobileView 2711T terminals purchased May 2016 or later.

You must disable EWF before you configure VNC Server settings, and then enable EWF again afterwards. For more information, see [Enhanced Write Filter \(EWF\) on page 57](#).

To activate and configure VNC Server, perform the following steps.

1. On the MobileView 2711T terminal desktop, tap VNC Server.

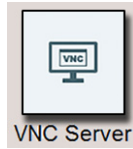

2. A dialog box asks if you wish to toggle (activate if off, deactivate if on) VNC Server.

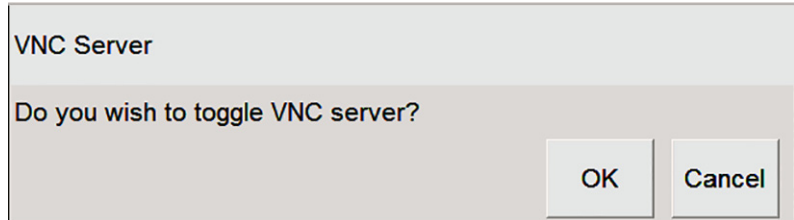

3. Adjust settings on the various tabs in the VNC dialog box to your communication needs.

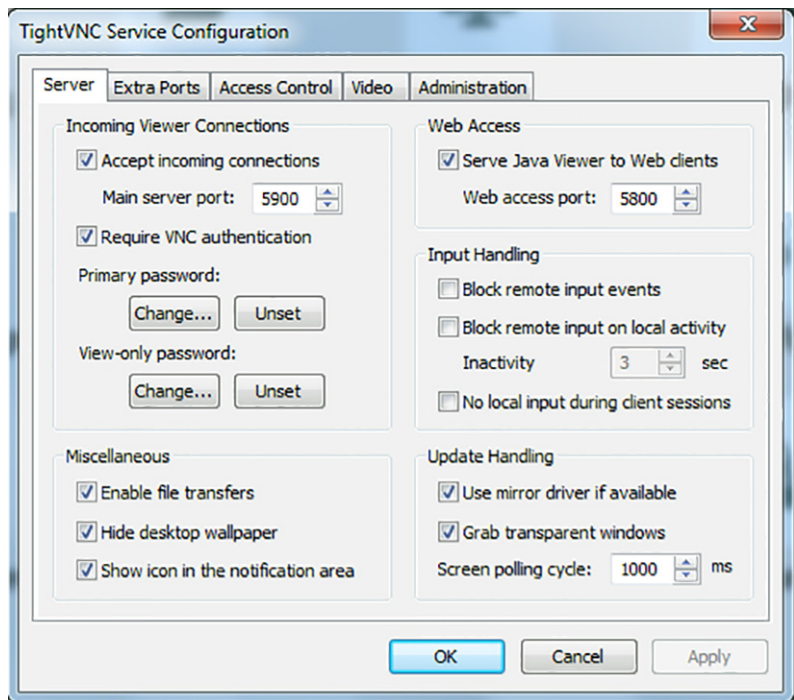

4. When you are finished, tap OK to exit VNC Server.

IMPORTANT When VNC Server is active, only steps 1 and 2 are performed to deactivate the application.

System Config

Use the System Config icon to update the BIOS or firmware of the MobileView 2711T terminal.

IMPORTANT Only someone with administrator privileges can perform BIOS or firmware updates.

You must disable EWF before you configure System Config settings, and then enable EWF again afterwards. For more information, see [Enhanced Write Filter \(EWF\) on page 57](#).

1. On the MobileView 2711T terminal desktop, tap System Config.



This dialog box appears.

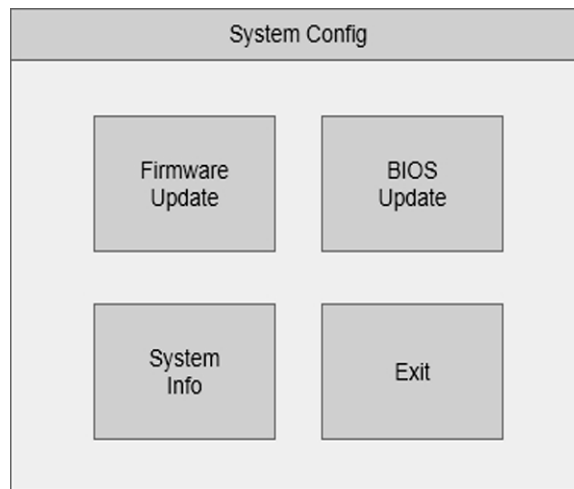

Update the Firmware

To update the firmware, perform the following steps.

IMPORTANT Firmware updates can apply to MobileView terminals and IP65 junction boxes.

1. From your personal computer, access the Rockwell Automation Product Compatibility and Download Center (PCDC):
<http://compatibility.rockwellautomation.com/Pages/home.aspx>
2. Under Download, click Find Downloads.
3. In the Product Search field, use MobileView as your search criteria.

4. Follow the instructions on the site to download the firmware (UPD) file to your personal computer.

TIP You must be registered with the Rockwell Automation PCDC website to download files.

5. Attach a FAT32-formatted USB storage device to the computer that is appropriately sized for the UPD file.
6. Copy the UPD file from your personal computer to the attached USB storage drive.
7. Remove the USB storage device from your personal computer and insert it into the USB port on the back of the MobileView 2711T terminal.
8. On the System Config dialog box, tap Firmware Update.
Firmware Update automatically finds available firmware files.
9. Tap to select a UPD file for the update.

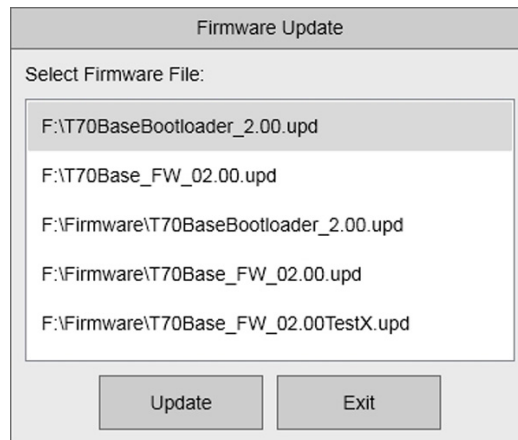

TIP The appropriate UPD file is a bootloader flash file, which usually contains 'BL' or 'Bootloader' in the file name and has a maximum file size of 32 KB.

This file format applies to firmware updates for MobileView terminals and IP65 junction boxes.

10. Tap Update.

A dialog box appears when the update is completed.

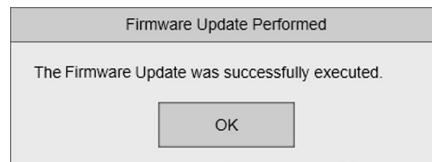

11. Tap OK.
12. Tap Exit on the Firmware Update screen.
13. Tap Exit on the System Config screen.

Update the BIOS

To update the BIOS, perform the following steps.

IMPORTANT See [page 75](#) to restore the BIOS to its default settings, and [page 77](#) to change the BIOS password.

1. From your personal computer, access the Rockwell Automation Product Compatibility and Download Center (PCDC):
<http://compatibility.rockwellautomation.com/Pages/home.aspx>
2. Under Download, click Find Downloads.
3. In the Product Search field, use MobileView as your search criteria.
4. Follow the instructions on the site to download the BIOS (ROM) file to your personal computer.

TIP You must be registered with the Rockwell Automation PCDC website to download files.

5. Attach a FAT32-formatted USB storage device to the computer that is appropriately sized for the ROM file.
6. Copy the ROM file from your personal computer to the attached USB storage drive.
7. Remove the USB storage device from your personal computer and insert it into the USB port on the back of the MobileView 2711T terminal.
8. On the System Config dialog box, tap BIOS Update.
BIOS Update automatically finds available BIOS files.
9. Tap to select a ROM file for the update.

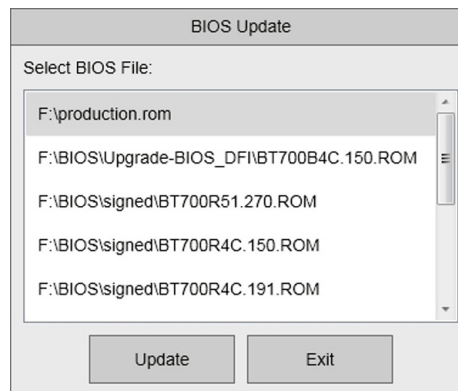

11. Tap Update.

A dialog box appears when the update is completed.

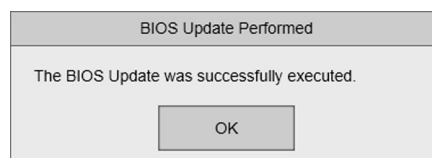

12. Tap OK.

13. Tap Exit on the BIOS Update screen.
14. Tap Exit on the System Config screen.

Network Settings

To configure the Ethernet communications of your MobileView 2711T terminal, perform the following steps.

1. On the MobileView 2711T terminal desktop, tap Network Settings.



The Local Area Connection icon appears with the network cable unplugged.

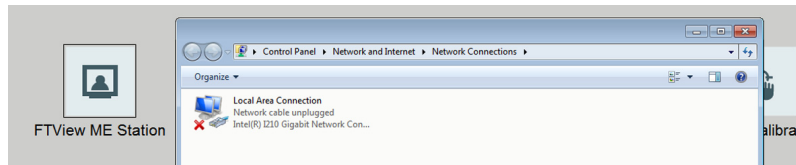

TIP You can also tap Control Panel>Network and Internet>Network Connections to access the same screen.

2. Touch and hold for about three seconds, and then release.
A right-click menu appears.
3. Tap Properties.
4. On the Properties dialog box, tap to select Internet Protocol Version 4 (TCP/IPv4).

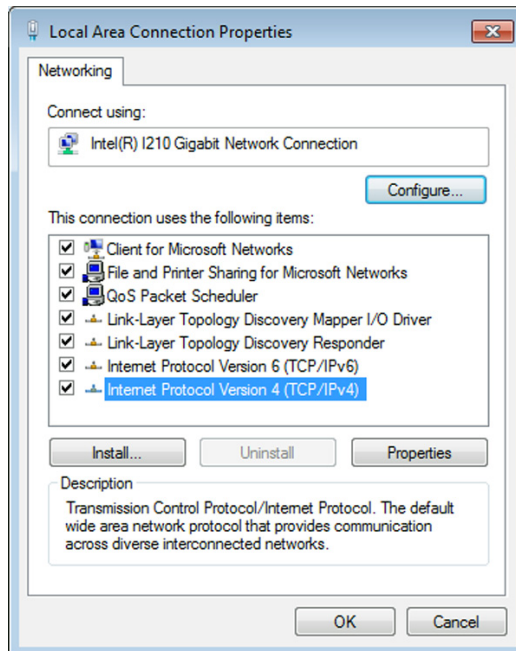

5. Tap Properties.

6. On the General tab, tap one of the following buttons:
 - ‘Obtain an IP address automatically’ if you have a DHCP server on your network that assigns IP addresses to the MobileView 2711T terminal.
 - ‘Use the following IP address’ to assign a static IP address. Complete the three text boxes with information from your network administrator or ISP.

Use the on-screen keyboard or an external keyboard to enter the text.

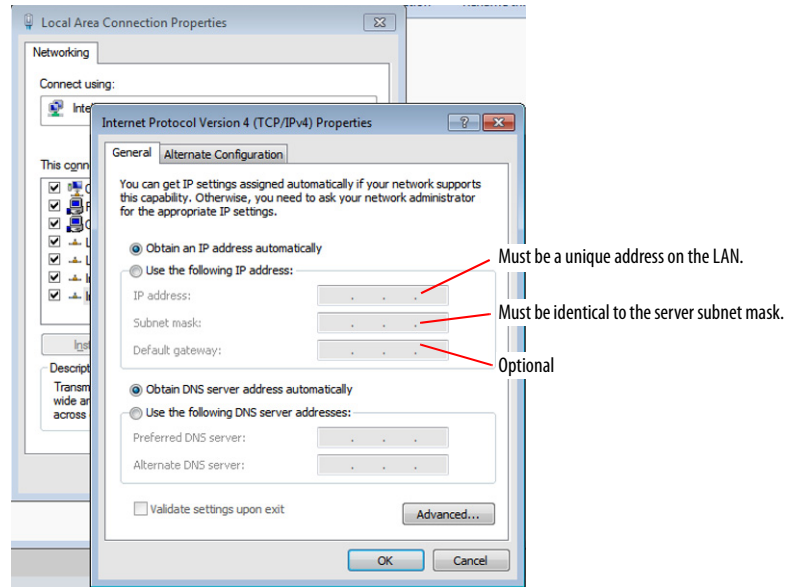

7. Tap OK.
8. Tap Close on the Local Connection Properties dialog.
9. Close the Network Connections window to return to the MobileView 2711T terminal desktop.

Remote Desktop

Use the Remote Desktop icon to connect to another device, such as a personal computer.

IMPORTANT Verify that your network settings have been configured before you set up remote access. For more information on network settings, see [page 72](#). You must disable EWF before you configure Remote Desktop settings, and then enable EWF again afterwards. For more information, see [Enhanced Write Filter \(EWF\) on page 57](#).

To set up remote access, perform the following steps.

1. On the MobileView 2711T terminal desktop, tap Remote Desktop.

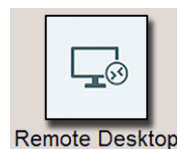

- 2. In the Computer field, enter the computer name to access remotely.

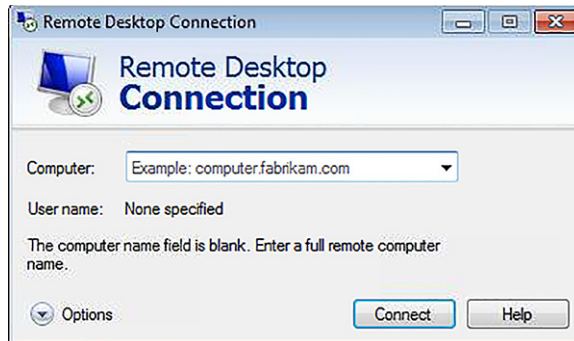

- 3. Click the Options button to configure remote access options.

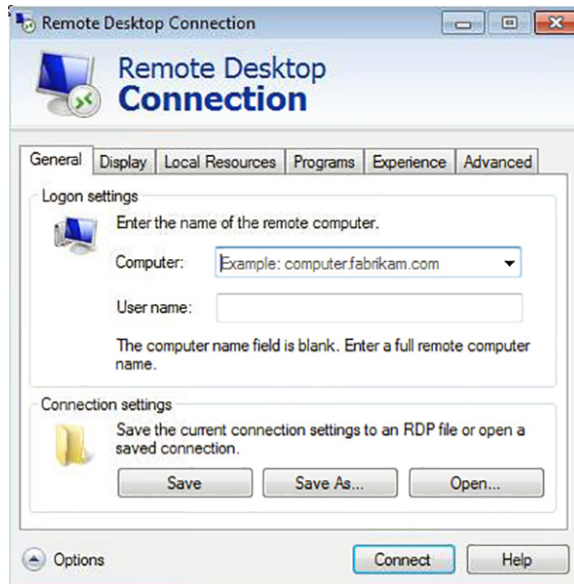

- 4. Click Connect to complete the remote access setup.

Touch Calibration

Use this feature to calibrate touch screen sensitivity. Follow the instructions that are displayed during calibration.

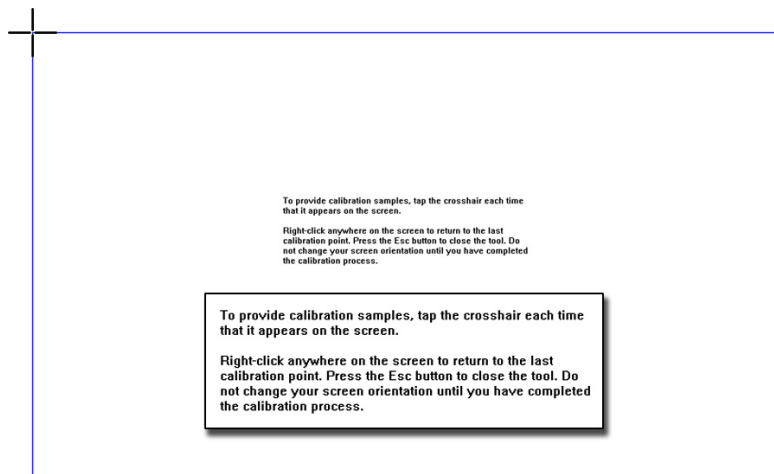

Rescue

When the following conditions are present, the MobileView 2711T terminal can get 'stuck' in an application loop:

- The FactoryTalk ME application does not have a shutdown button
- EWF is enabled with the FactoryTalk ME application set to auto-run
- Hibernate once, resume many (HORM) is being used

To resolve this loop with Rescue, perform the following steps.

1. On the MobileView 2711T terminal desktop, tap Rescue.
2. This dialog box appears.

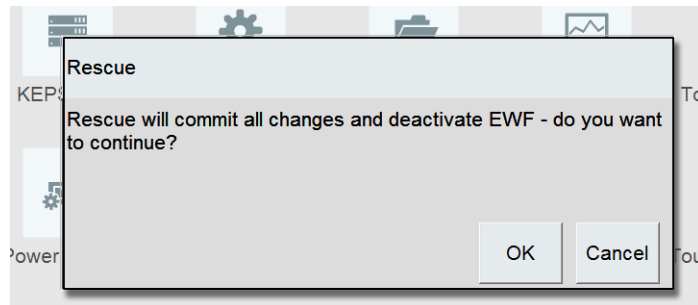

4. Tap OK.

The MobileView 2711T terminal automatically restarts.

Restore the Default BIOS

To restore the BIOS to the settings that were shipped with the MobileView 2711T terminal, perform the following steps.

IMPORTANT Only someone with administrator privileges can restore the BIOS settings. You need an external keyboard that is connected to the USB port on the back of the MobileView 2711T terminal to change BIOS information.

1. Restart or power up the MobileView 2711T terminal.
2. Press F7 on the front of the MobileView 2711T terminal when the start-up screen appears.



3. With the external keyboard, enter the default BIOS password.
 - The administrator default password is 4041
 - The user default password is 7090



4. Toggle down to Enter Setup and press Enter on the keyboard.

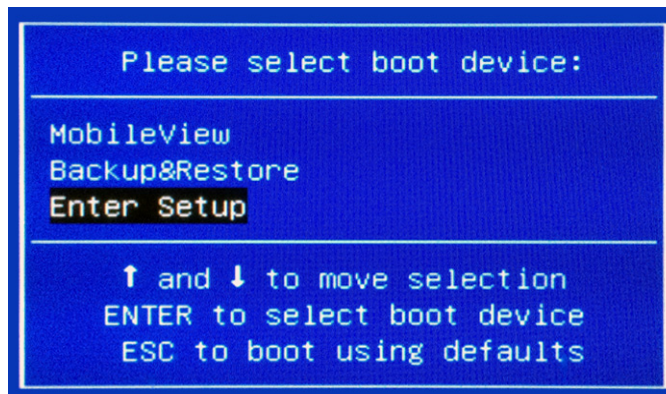

5. Toggle across to the Save and Exit tab.
6. On the Save and Exit tab, toggle down to Restore Defaults and press Enter on the keyboard.
7. Tap Yes on the confirmation dialog box, and press Enter on the keyboard.

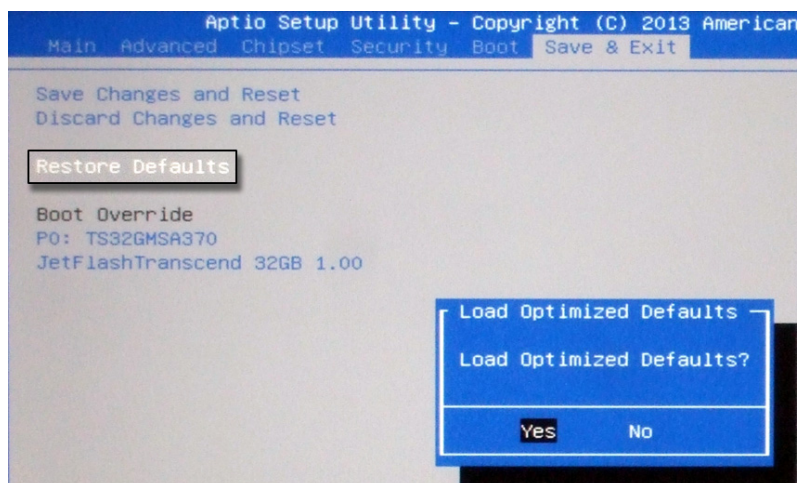

8. Toggle up to Save Changes and Reset and press Enter on the keyboard.

- Tap Yes on the confirmation dialog box and press Enter on the keyboard.

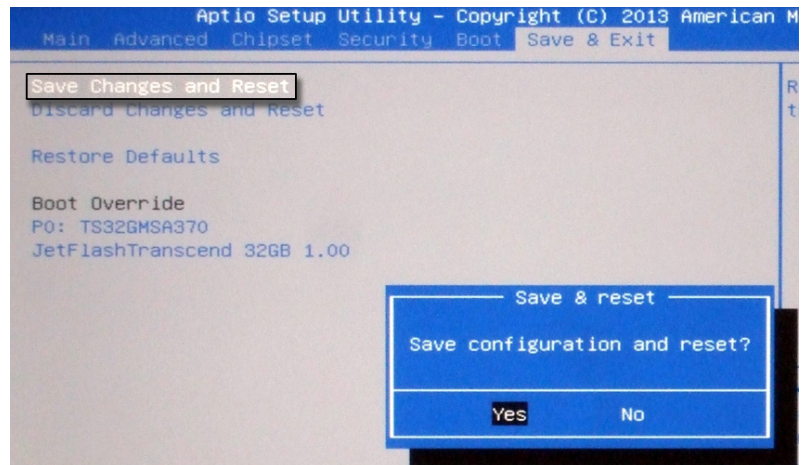

The MobileView 2711T terminal automatically restarts with the default BIOS settings.

Change the BIOS Password

To change the BIOS password from the default that is shipped with the MobileView 2711T terminal, perform the following steps.

IMPORTANT Only someone with administrator privileges can change the BIOS password. You need an external keyboard that is connected to the USB port on the back of the MobileView 2711T terminal to change BIOS information.

- Restart or power up the MobileView 2711T terminal.
- Press F7 when the start-up screen appears.



- With the external keyboard, enter the default BIOS password. See [step 3](#) on [page 76](#) for the appropriate password.

4. On the boot device screen, toggle down to Enter Setup and press Enter on the keyboard.

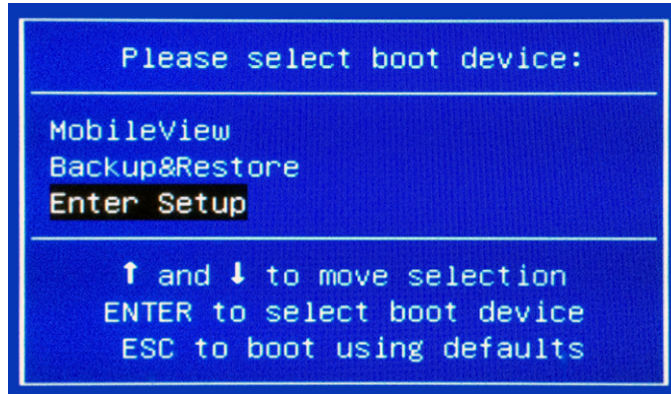

The BIOS set-up utility appears on the Main tab.

5. Toggle across to the Security tab.
6. On the Security tab, toggle down to Administrator Password or User Password, and press Enter.
7. With the external keyboard, enter the current default BIOS password and press Enter.

See [step 3](#) on [page 76](#) for the appropriate password.

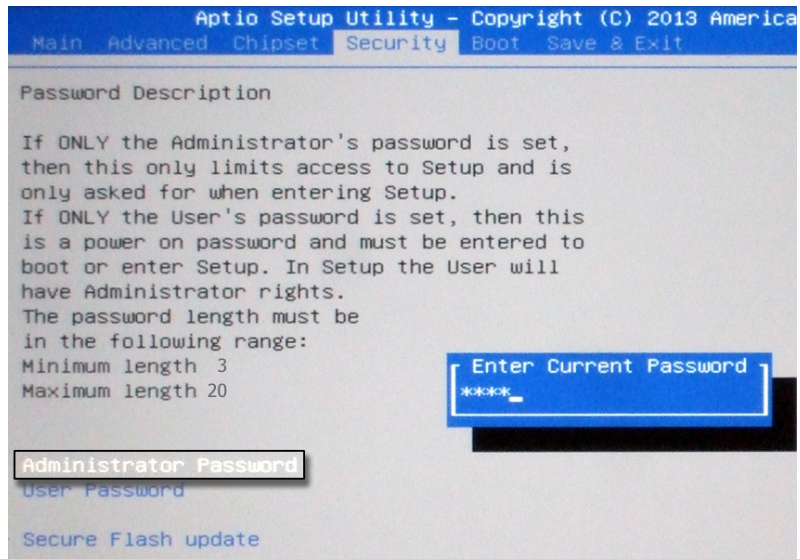

8. Read Password Description to assist with your new password.

9. With the external keyboard, enter your new password and press Enter.

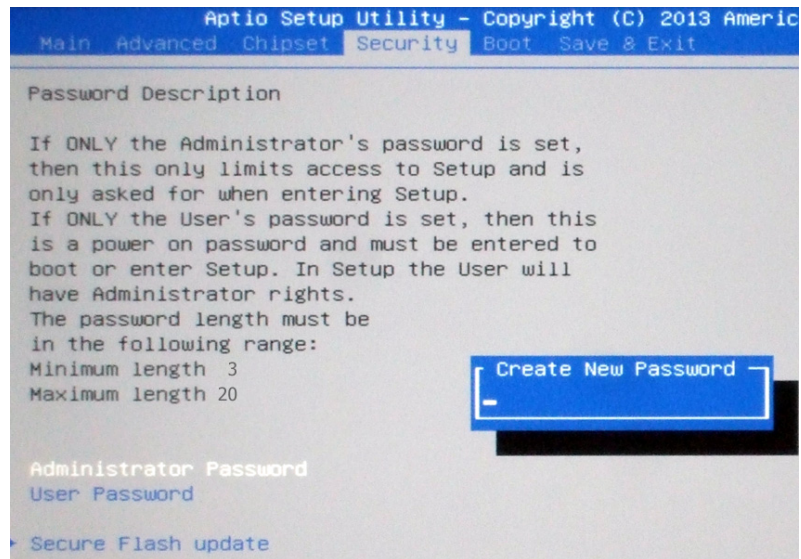

10. After you create your password, toggle up and across to the Save and Exit tab.
11. On the Save and Exit tab, toggle down to Save Changes and Reset.
12. Press Enter on the keyboard.
13. Select Yes on the confirmation dialog box and press Enter on the keyboard.

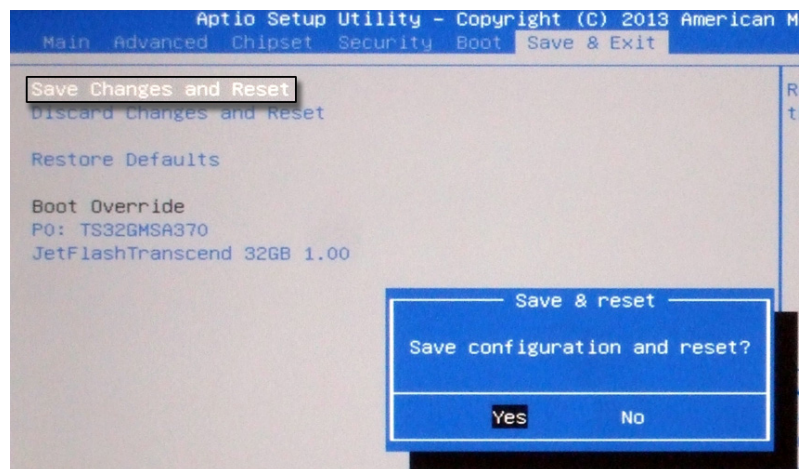

The MobileView 2711T terminal automatically restarts with the new password.

Back Up the Operating System Image

To back up the operating system (OS) image on the MobileView 2711T terminal, perform the following steps.

IMPORTANT If you back up the OS image, then certain preparations (sysprep) are needed for proper EWF functionality. For more information, see the Rockwell Automation Knowledgebase.

You need an external keyboard and a USB storage device (at least 32 GB) to back up the OS image.

There is only one USB port on the back of the MobileView 2711T terminal, so Rockwell Automation recommends that you use a USB hub to connect both devices simultaneously.

1. Restart or power up the MobileView 2711T terminal.
2. Press F7 when the start-up screen appears.



3. With the external keyboard, enter the BIOS password. See [step 3 on page 76](#) for default passwords.

IMPORTANT The default passwords only work if you have not changed them through the steps in [Change the BIOS Password on page 77](#).

4. On the boot device screen, toggle down to Backup and Restore, and press Enter on the keyboard.

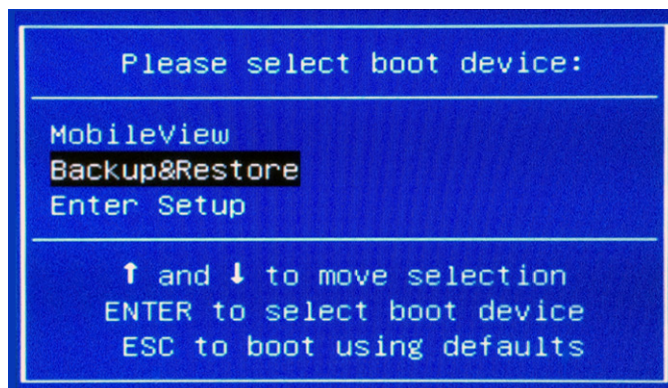

The Bootable Service System (BSS) screen appears.



TIP The BSS screen can take up to 60 seconds to appear.

5. From the BSS screen, tap Backup & Restore.
6. From the Backup & Restore screen, tap Backup.

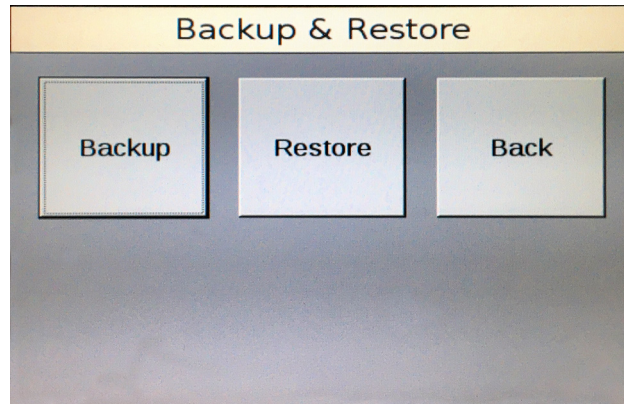

7. From the BSS Select Drive screen, tap to select the attached USB storage drive for where to back up.

TIP Use a USB storage drive that is at least 32 GB.

8. Tap to select the appropriate file to back up to the USB storage drive.
9. Tap Backup.
10. On the back-up confirmation dialog box, tap OK.

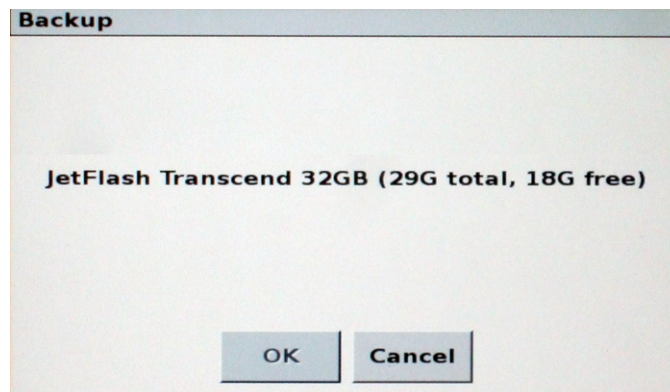

A dialog box with a progress bar monitors the backup.

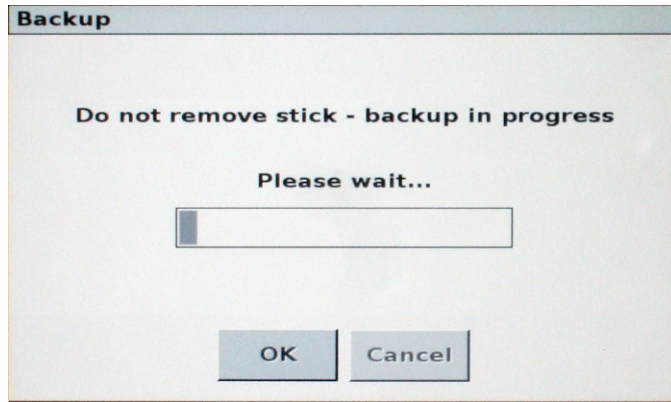

TIP The OS image backup can take up to 30 minutes to complete.

11. This dialog box appears when the backup is finished.

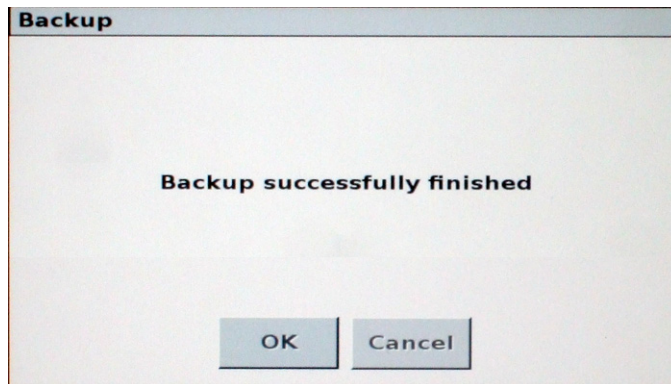

12. Tap OK.

You are returned to the BSS screen.

13. On the BSS screen, tap Shutdown to power down the terminal or Reboot to restart the terminal.

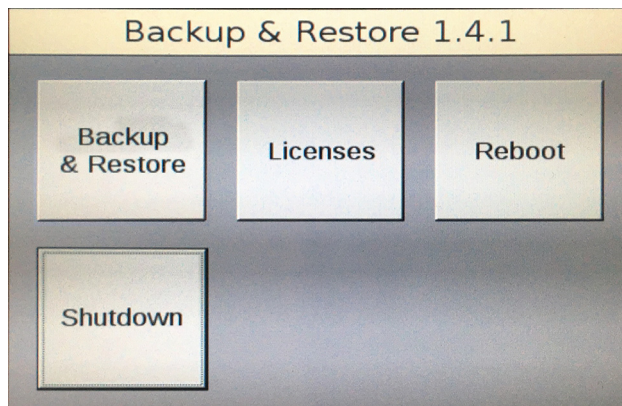

Restore the Operating System Image

To restore the operating system (OS) image on the MobileView 2711T terminal, perform the following steps.

IMPORTANT If you restore the OS image, then you remove any configured settings with the current image.

You need an external keyboard and a USB storage device (at least 32 GB) to back up the OS image.

There is only one USB port on the back of the MobileView 2711T terminal, so Rockwell Automation recommends that you use a USB hub to connect both devices simultaneously.

1. Restart or power up the MobileView 2711T terminal.
2. Press F7 when the start-up screen appears.



3. With the external keyboard, enter the BIOS password. See [step 3 on page 76](#) for default passwords.

IMPORTANT The default passwords only work if you have not changed them through the steps in [Change the BIOS Password on page 77](#).

4. On the boot device screen, toggle down to Backup and Restore, and press Enter on the keyboard.

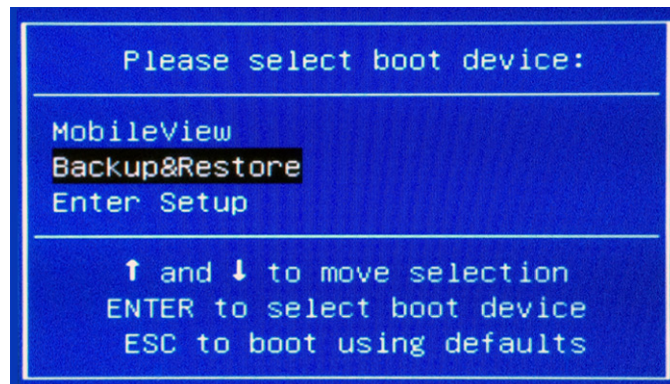

The Bootable Service System (BSS) screen appears.

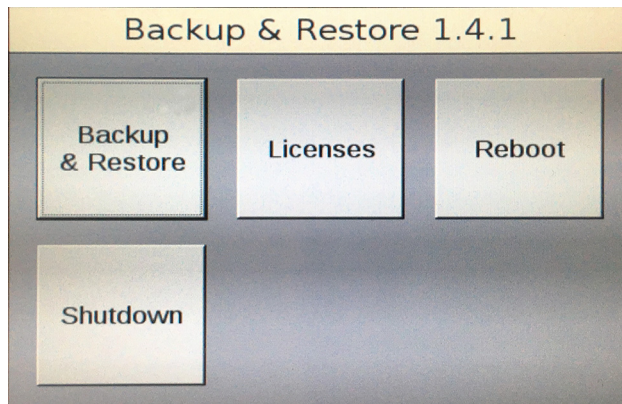

TIP The BSS screen can take up to 60 seconds to appear.

5. From the BSS screen, tap Backup & Restore.
6. From the Backup & Restore screen, tap Restore.

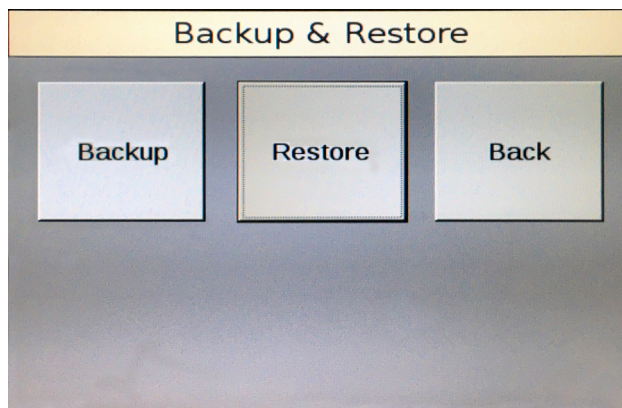

7. From the BSS Select Drive screen, tap to select the attached USB storage drive from where to restore.

BSS searches for image files in the 'images' folder on the attached USB storage drive.

IMPORTANT Verify that the USB storage drive is formatted with NTFS and the drive contains an OS image from one of the following sources:

- From the VMDK files that are generated from the OS image backup that is detailed on [page 80](#)
- From an OS image with factory settings available from the Rockwell Automation Product Compatibility and Download Center:
<http://www.rockwellautomation.com/support/pcdc.page>

8. Tap to select the appropriate file on the USB storage drive.

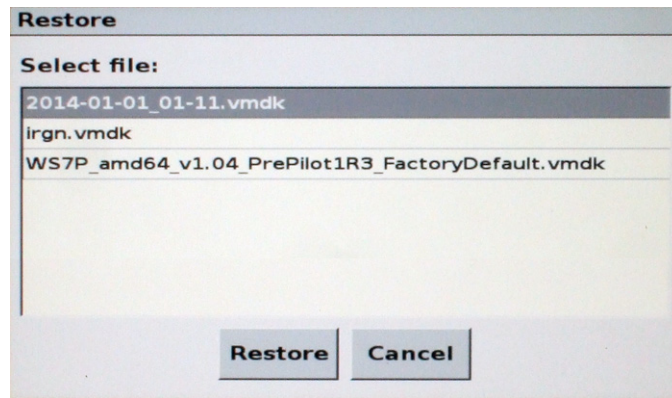

9. Tap Restore.
10. On the restore confirmation dialog box, tap OK.

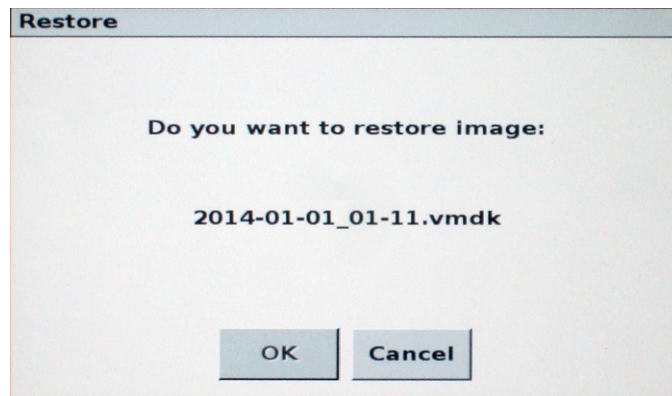

A dialog box with a progress bar monitors the restoration.



TIP The restoration can take up to 20 minutes to complete.

This dialog box appears when the restoration is finished.

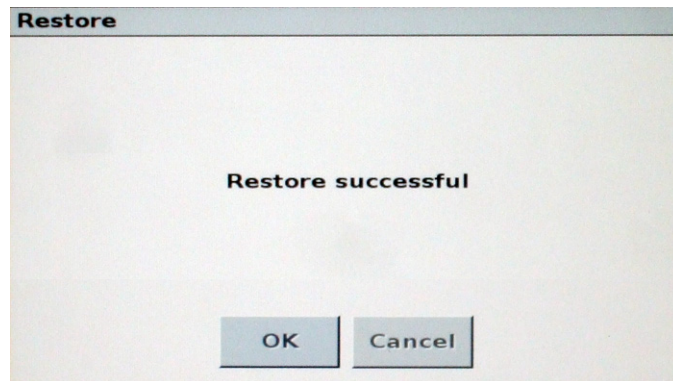

11. Tap OK.

You are returned to the BSS screen.

12. On the BSS screen, tap Shutdown to power down the terminal or Reboot to restart the terminal.

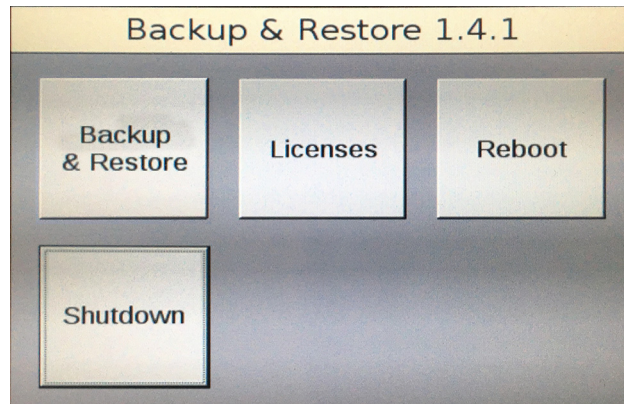

Maintain and Troubleshoot the MobileView Terminal and IP65 Junction Box

Topic	Page
Clean the MobileView 2711T Terminal	87
Handle and Care for the MobileView 2711T Terminal and IP65 Junction Box	88
Chemical Resistance	88
Real-time Clock Battery	89
Troubleshoot the MobileView 2711T Terminal	89
Provide Information to Technical Support	91
Troubleshoot the MobileView 2711T Terminal	91

Clean the MobileView 2711T Terminal

For the touch screen, clean gently with a lint-free cloth. Dampen with a mixture of 50% water and 50% isopropyl alcohol. If needed, clean the unit daily when it is used in harsh environments.

For the housing, dampen a cloth with a mixture of 50% water and 50% isopropyl alcohol or a mild detergent. Do not use harsh cleaning additives.

TIP IP65 junction boxes do not require maintenance or cleaning.

Handle and Care for the MobileView 2711T Terminal and IP65 Junction Box

The MobileView™ 2711T terminal and IP65 junction box are high-quality devices that are equipped with state-of-the-art electronics.

To avoid malfunctions or damage through improper handling, follow these instructions during operation.



ATTENTION: Do not operate a terminal or any junction box if the cable is damaged or pinched. To avoid damage to the cable, do not place the cable over or around sharp objects.

- When the terminal is not in use, hang the terminal in the mounting bracket or place inside a cabinet or enclosure.
 - To avoid dropping the terminal, do not set the terminal on unstable surfaces and keep the cable clear of high traffic areas.
 - To avoid damage to the operating elements, do not set the terminal on its operating side.
 - If the terminal falls to the ground, test the E-stop switch and enabling switch before operating the machine/plant.
 - Do not set the terminal near heat sources and avoid direct sunlight.
 - Do not expose the terminal or IP65 junction boxes to excessive mechanical vibrations, excessive dust, humidity, or strong magnetic fields.
 - Help prevent foreign objects or liquids from getting into the terminal or IP65 junction box. Check the protective covers of the device regularly. Make sure that all screws are firmly tightened, and that the housing and cable entrance is not damaged.
 - Turn off the power supply before you remove the back cover of the MobileView 2711T terminal or you remove an IP65 junction box from its back plate. When the back cover or back plate are removed, the terminal or IP65 junction box are sensitive to ESD.
 - If a terminal or junction box exhibit any anomaly, have the unit thoroughly and fully tested by the manufacturer or authorized repair dealer before you operate the terminal again.
-

Chemical Resistance

MobileView 2711T terminals and IP65 junction boxes resist the following chemicals:

- Isopropanol
- Glass cleaner
- Multi-purpose grease
- General-purpose lubricants

Real-time Clock Battery

The MobileView 2711T terminal uses nonvolatile memory that requires a real-time clock (RTC) lithium battery to retain system information when power is removed. The battery has a 17-year life.

The RTC battery is soldered to the main circuit board, non-serviceable, and therefore not intended to be replaced during the life of the MobileView 2711T terminal.

Troubleshoot the MobileView 2711T Terminal

The following table lists possible anomalies that can occur with your terminal and solutions to the anomalies.

Anomaly	Solution	Page
Terminal does not power up	Check for 24V DC power on the connector of the MobileView junction box. <ul style="list-style-type: none"> • For 2711T-JBIP20DC, the IP20 junction box: Check the terminal connections at X1 and X2 of the junction box. • For 2711T-JBIP65DC1, the IP65 junction box with cord grip connections: Check the power connections at the S16 terminal of the junction box. • For 2711T-JBIP65DM1, the IP65 junction box with M12 On-Machine™ connections: Check for a solid connection between the power supply cable and the cable connection on the junction box. 	36 44 49
	Check for a solid connection between the MobileView connection cable and the cable connection of the junction box. <p style="text-align: right;">For IP20 junction boxes For IP65 junction boxes</p>	36 52
	Check the terminal connections to the main control board of the MobileView 2711T terminal.	24
Terminal screen is dim or black	If the screen is readable: <ul style="list-style-type: none"> a. Adjust the screen brightness at the bottom of the window that appears. a. From the MobileView terminal desktop, tap Power Options. 	30, 56
	If the screen is black: <ul style="list-style-type: none"> • Tap the touch screen or any of the keypad buttons to de-activate the screen saver. • Check power to the terminal. Follow instructions for anomaly, 'Terminal does not power up.' • If the screen is blinking or rapidly changing brightness, a corrupted registry or OS image can exist. <ul style="list-style-type: none"> a. Restore the OS image. b. If an OS image restoration does not correct the anomaly, contact Rockwell Automation® Technical Support. 	83 91
Difficulty with touch screen selections	The touch screen can be out of alignment. Recalibrate the touch screen.	74
Terminal screen is static (locked up). Touch screen and keypad activations do not initiate any changes.	Check Ethernet communications. See the next anomaly, 'Terminal does not communicate on Ethernet network.'	
Terminal does not communicate on Ethernet network	Check Ethernet cable connections at the MobileView junction box and your Ethernet hub. <p style="text-align: right;">For IP20 junction boxes For IP65 junction boxes</p>	28, 39 29, 45, 49
	Try to ping the MobileView 2711T terminal from a personal computer in your network to check for correct configuration settings, then check MobileView 2711T terminal settings.	72
	If you are using a DHCP server, check if the DHCP function is set in the network settings of the MobileView 2711T terminal.	73
	If you connect to the Ethernet network with fixed settings, verify that the IP address, subnet mask, and default Gateway-network settings are correct in the MobileView 2711T terminal.	73
	Check the Ethernet connection on the MobileView 2711T terminal.	24, 28, 29
Program memory low	From the terminal desktop, tap File Explorer. Use File Explorer to clean up or delete unnecessary files.	56
An error message alerts you to install Windows	Power to the MobileView terminal was temporarily interrupted during the Windows setup process. Restore the OS image with an image file downloaded from the Rockwell Automation PCDC site.	83
The Windows OS image is corrupt	Restore the OS image from a backed up image or with an image file downloaded from the Rockwell Automation PCDC site.	80, 83

Troubleshoot the IP65 Junction Box

There are three LED lights and a status indicator bar on the front of the IP65 junction box. For more information on these lights and the bar, see [IP65 Junction Box Status Lights on page 52](#).

[Table 9](#) explains what colors can display on the status indicator bar when an error is detected and their significance.

Table 9 - IP65 Junction Box Status Indicator Bar Error Colors and Descriptions

Color ⁽¹⁾	Status Description	Solution
Solid blue	The illuminated E-stop button on the second generation MobileView terminal is faulty.	Replace the faulty illuminated E-stop button within five days or use another second generation MobileView terminal with a functional illuminated E-stop button. IMPORTANT: If you do not replace the faulty illuminated E-stop button within five days, another fault color is triggered on the status indicator bar. See the first row of 'Blinking half yellow, half red'.
Blinking half yellow, half red	The faulty illuminated E-stop button on the second generation MobileView terminal connected to the IP65 junction box was not replaced within five days after being detected, which triggers an emergency stop.	Replace the faulty illuminated E-stop button within five days or use another second generation MobileView terminal with a functional illuminated E-stop button.
	The E-stop circuit connection between the second generation MobileView terminal and IP65 junction box is not established, which triggers an emergency stop. The current E-stop status of the system or machine is different than the 'remembered' E-stop status of the IP65 junction box.	<ol style="list-style-type: none"> 1. Disconnect the second generation MobileView terminal and 22-pin connection cable from the IP65 junction box. 2. Verify that the illuminated E-stop button on the second generation MobileView terminal is unlocked (pressed and released). 3. Reset the system or machine. 4. Reconnect the second generation MobileView terminal and 22-pin connection cable to the IP65 junction box within 10 seconds of returned power. 5. If the problem persists, verify that the emergency stop wiring or connections to the IP65 junction box are correct. For 2711T-JBIP65DC1, the IP65 junction box with cord grip connections, verify that the E-stop wiring connections are correct at the S16 terminal of the junction box. For more information, see S16 Terminal Pin Descriptions on page 44.
Blinking red	A faulty connection is detected	<ol style="list-style-type: none"> 1. Disconnect the second generation MobileView terminal and 22-pin connection cable from the IP65 junction box. 2. Insert a black bridge connector in the IP65 junction box. 3. Reset the system or machine. 4. Verify that the LED lights and status indicator bar on the front of the IP65 junction box are illuminated green. If the IP65 junction box displays any colors other than green, the junction box is faulty and needs to be replaced. 5. Verify that the illuminated E-stop button on the second generation MobileView terminal is unlocked (pressed and released). 6. Remove the black bridge connector, and reconnect the second generation MobileView terminal and 22-pin connection cable to the IP65 junction box. If the IP65 junction box returns to the blinking red status, either the connection cable or second generation MobileView terminal is faulty and needs to be replaced.
	The E-stop circuits between the second generation MobileView terminal and the IP65 junction box are cross circuited	

(1) The IP65 junction box must have power (shown as green for power LED) for the status bar to display status.

Provide Information to Technical Support

To contact Rockwell Automation support, see the back cover. Be prepared to provide the following information:

- Detailed description of anomaly, including circumstances of when it occurred (for example, programs that were running and what steps were taken)
- Any steps taken to try to resolve an anomaly
- System information for the MobileView 2711T terminal:
 - a. From the terminal desktop, tap System Config
 - b. On the System Config dialog box, tap System Info

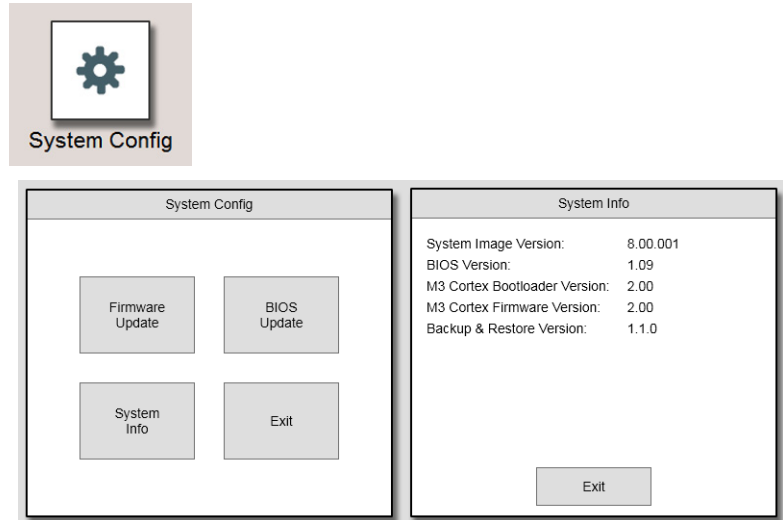

The system-image version number is most important, but other version information can also be helpful.

Ship or Transport a MobileView Device

If you must ship a MobileView terminal or a MobileView junction box via common carrier or otherwise transport it to another location for service or any other reason, you must first uninstall the device and place it in its original packing material.

IMPORTANT Always use the original packaging material to ship or transport a MobileView terminal or MobileView junction box.

Verify that all applicable environmental conditions in [Table 12 on page 94](#) are fulfilled while the device is shipped or transported.

Rockwell Automation is not responsible for damage to any MobileView device that does not follow the guidelines in this section.

Dispose of a MobileView Device



At the end of its life, a MobileView device must be collected separately from any unsorted municipal waste.

You cannot dispose of a MobileView 2711T terminal or MobileView junction box like other waste material. Most MobileView devices contain heavy metals that can contaminate the earth. Therefore, check with local health and sanitation agencies for ways to safely dispose of MobileView 2711T terminals and MobileView junction boxes.

Specifications

MobileView Terminals

Table 10 - General

Attribute	Cat. No. 2711T-						
	T10R1N1	B10I1N1	B10R1K1	B10R1M1	F10G1N1	T10G1N1	T10G1N1-TC
Processor	Intel® Atom™ E3815, 1.46 GHz						
Operating system	Microsoft Windows Embedded Standard 7 SP1, 64 bit						No ⁽¹⁾
Memory	4 GB DRAM/32 GB Flash						No ⁽¹⁾
Display Size (in.) Color/resolution Resistive touch screen	10.1 WXGA/1280 x 800 pixels Analog resistive						
Function keys	No	Yes				No	
3-position enable switch	Yes						
2-circuit E-stop	Yes						
USB drive slot	Yes (2.0)						
Communication	10/100 Ethernet						
Dimensions	See page 11						
Weight	1550 g (3.42 lb)						

(1) The operating system and 32 GB flash drive are not included with the 2711T-T10G1N1-TC MobileView™ terminal.

Table 11 - Electrical

Attribute	Cat. No. 2711T-						
	T10R1N1	B10I1N1	B10R1K1	B10R1M1	F10G1N1	T10G1N1	T10G1N1-TC
Rated supply voltage	24V DC						
Supply voltage tolerance range	19.2...30V DC (EN 61131-2)						
Input current	500 mA at 24V DC						
Peak inrush current	5.6 A (max)						

Table 12 - Environmental

Attribute	Cat. No. 2711T-						
	T10R1N1	B10I1N1	B10R1K1	B10R1M1	F10G1N1	T10G1N1	T10G1N1-TC
Operating temperature	0...45 °C (32...113 °F)						
Storage temperature	-25...+70 °C (-13...+158 °F)						
Relative humidity (noncondensing)	5...95% at 0...45 °C (32...113 °F)						
Vibration (operating)	5...150 Hz 5...8.4 Hz, 3.5 mm p-p 8.4...150 Hz, 1 G peak						
Shock (operating)	15 G (½ Sine, 11 ms) IEC 60068-2-27						
Altitude	0...2,000 m (0...6,562 ft)						

IP20 Junction Box

Table 13 - General, IP20

Attribute	Cat. No. 2711T-JBIP20DC
USB drive slot	Yes (2.0)
Communication	10/100 Ethernet
Dimensions	See page 36
Weight, approx	220 g (0.49 lb)

Table 14 - Electrical, IP20

Attribute	Cat. No. 2711T-JBIP20DC
Rated supply voltage	24V DC
Supply voltage tolerance range	19.2...30V DC (EN 61131-2)
Input current ⁽¹⁾	500 mA at 24V DC
Peak inrush current	5.6 A (max)
Connector cycle duration ⁽²⁾	5000 (typical)

(1) Without a MobileView terminal connected to the junction box.

(2) Applies to silver 20-pin cable connector. Test the connector monthly to verify that it locks properly. Remove the IP20 junction box from operation after the connection cycles have been exceeded.

Table 15 - Environmental, IP20

Attribute	Cat. No. 2711T-JBIP20DC
Operating temperature	5...45 °C (41...113 °F)
Storage temperature	-25...+70 °C (-13...+158 °F)
Relative humidity (noncondensing)	5...95% at 5...45 °C (41...113 °F)
Vibration (operating)	5...150 Hz 5...8.4 Hz, 3.5 mm p-p 8.4...150 Hz, 1 G peak
Shock (operating)	15 G (½ Sine, 11 msec) IEC 60068-2-27
Altitude	0...2,000 m (0...6,562 ft)

IP65 Junction Boxes

Table 16 - General, IP65

Attribute	Cat. No. 2711T-	
	JBIP65DC1	JBIP65DM1
USB drive slot	Yes (2.0)	
Communication	10/100 Ethernet	
Dimensions	See page 41	
Weight, approx	500 g (1.1 lb)	

Table 17 - Electrical, IP65

Attribute	Cat. No. 2711T-	
	JBIP65DC1	JBIP65DM1
Rated supply voltage	24V DC	
Supply voltage tolerance range	19.2...30V DC (EN 61131-2)	
Input current ⁽¹⁾	500 mA at 24V DC	
Peak inrush current	5.6 A (max)	
Connector cycle duration ⁽²⁾	5000 (typical)	
E-stop functions	<ul style="list-style-type: none"> • Voltage, min • Current, min (Ie) • Current carrying capacity, min • Usage category • Reaction time, max⁽³⁾ • Isolation • Bounce time • Proof test interval⁽⁴⁾ • Switching cycles relay • PFH_d 	
	<ul style="list-style-type: none"> • 5V DC per contact • 10 mA per contact • 1000 mA per contact • DC-13 (IEC 60947-5-1) • 19 ms • 500V AC to rest • <10 ms • 20 years • 10 x 10⁵ • 9.79 x 10⁻¹⁰ (1/h) 	

(1) Without a MobileView terminal connected to the junction box.

(2) Applies to black, 22-pin cable connector. Test the connector monthly to verify that it locks properly. Remove the IP65 junction box from operation after the connection cycles have been exceeded.

(3) Reaction time is time before the E-stop is triggered.

(4) Decommission the safety function once the E-stop has been activated 250,000 times or after 20 years, whichever comes first.

Table 18 - Environmental, IP65

Attribute	Cat. No. 2711T-	
	JBIP65DC1	JBIP65DM1
Operating temperature	5...45 °C (41...113 °F)	
Storage temperature	-25...+70 °C (-13...+158 °F)	
Relative humidity (noncondensing)	5...95% at 5...45 °C (41...113 °F)	
Vibration (operating)	5...150 Hz 5...8.4 Hz, 3.5 mm p-p 8.4...150 Hz, 1 G peak	
Shock (operating)	15 G (½ Sine, 11 msec) IEC 60068-2-27	
Altitude	0...3,000 m (0...9,843 ft)	

MobileView Accessories

Table 19 - For First Generation MobileView Terminals (cat. nos. 2711T-B10R1K1, -B10R1M1, -F10G1N1, -T10G1N1, and -T10R1N1)

Cat. No.	Description
2711T-5MCABLE	Connection cable (5 m/16.4 ft) with silver connector to connect a 20-pin MobileView terminal to an IP20 junction box.
2711T-10MCABLE	Connection cable (10 m/32.8 ft) with silver connector to connect a 20-pin MobileView terminal to an IP20 junction box.
2711T-15MCABLE	Connection cable (15 m/49.2 ft) with silver connector to connect a 20-pin MobileView terminal to an IP20 junction box.
2711T-JBIP20DC	A 24V DC powered, IP20 junction box that includes a junction box cap.
2711T-JUMP	A silver, 20-pin bridge connector to bypass E-stop contactors in an IP20 MobileView junction box. ⁽¹⁾

(1) For applications where the customer plans to move one MobileView terminal between many MobileView junction boxes.

Table 20 - For Second Generation MobileView Terminals (cat. nos. 2711T-B10I1N1 and -T10I1N1-TC)

Cat. No.	Description
2711T-5MCABLE2	Connection cable (5 m/16.4 ft) with black connector to connect a 22-pin MobileView terminal to an IP65 junction box.
2711T-10MCABLE2	Connection cable (10 m/32.8 ft) with black connector to connect a 22-pin MobileView terminal to an IP65 junction box.
2711T-15MCABLE2	Connection cable (15 m/49.2 ft) with black connector to connect a 22-pin MobileView terminal to an IP65 junction box.
2711T-JBIP65DC1 ⁽¹⁾	A 24V DC powered, IP65 junction box with cord grips, and Box ID and E-stop bypass functionality.
2711T-JBIP65DM1 ⁽¹⁾	A 24V DC powered, IP65 junction box with M12 On-Machine™ connectors, and Box ID and E-stop bypass functionality.
2711T-JBBKCOVER	A back cover accessory plate for the 2711T-JBIP65DM1 junction box.
2711T-22JUMP	A black, 22-pin bridge connector to bypass E-stop contactors in an IP65 MobileView junction box. ⁽²⁾

(1) First generation MobileView terminals 2711T-T10G1N1 and 2711T-F10G1N1 can be used with IP65 junction boxes and 22-pin connection cables.

(2) For applications where the customer plans to move one MobileView terminal between many MobileView junction boxes.

Table 21 - For All MobileView Terminals

Cat. No.	Description
2711T-BRACKET	Mounting bracket for stationary operation or to store the terminal.
2711T-VMBRACKET	VESA mounting bracket for stationary operation, to store the terminal, or to lock the terminal for security reasons.

Standard and Agency Certifications

For declarations of conformity, certificates, and other certification details, visit the Rockwell Automation Product Certifications site at:

<http://www.rockwellautomation.com/certification/overview.page>

Region	Standards Group	Regulatory Standard
Americas	Safety	c-UL-us MobileView terminals: <ul style="list-style-type: none"> • UL 508 - Industrial Control Equipment • UL 1740 - Robotic Equipment⁽¹⁾ • CSA C22.2 No. 142 - Industrial Control Equipment • CSA Z434 - Robotic Equipment IP65 junction boxes: <ul style="list-style-type: none"> • UL 508 - Industrial Control Equipment • UL 61010-1 - Control Equipment • UL 61010-2-201 - Control Equipment • UL 1740 - Robotic Equipment • IEC 61508 - Functional Safety • CSA C22.2 No. 142 - Industrial Control Equipment • CSA Z434 - Robotic Equipment
	State of California	In accordance with California USA disclosure regarding any perchlorate content
Europe	Enclosure rating	IP65 per EN 60529
	Safety	EN 61131-2 - Programmable Controllers MobileView terminals: <ul style="list-style-type: none"> • EN ISO 13850 - Safety Function • EN 60204-1 - Safety Function IP65 junction boxes: <ul style="list-style-type: none"> • EN ISO 13850 - Safety Function • EN 60204-1 - Safety Function • EN ISO 13849-1 - Safety Function • EN ISO 10218-1 - Safety Function • EN 61131-2 - Programmable Controllers
	EMC	2014/30/EU
	Emissions	EN 61131-2
	Immunity	EN 61131-2
	REACH	Regulation No. 1907/2006 of the European Parliament
	RoHS	European RoHS 2011/65/EU Turkey RoHS (EEE Yönetmeliğine Uygundur. In Conformity with the EEE Regulation)
	WEEE	Waste Electrical and Electronic Equipment (WEEE) 2012/19/E
	Machinery Directive	The product safety functions of the MobileView 2711T series are in conformity with the essential requirements of the Machinery Directive (2006/42/EC) when installed and maintained in accordance with the instructions contained in the product documentation. The standards referenced above regarding the safety function have been applied.
	EU battery directive	2006/66/EC
Asia Pacific	Product certification China RoHS pollution control logo SJ/T113642006 RCM - Australian Radiocommunications Act, compliant with EN61000-6-4 Korean Clause 3, Article 58-2 of Radio Waves Act 위 기자재는 「전파법」 제58조의2 제3항에 따라 등록되었음을 증명합니다.	

(1) Does not apply to 2711T-F10GIN1 and 2711T-T10G1N1 MobileView terminals with gray push buttons.

Notes:

C

cables
connection cable 28, 29
certifications, standard and agency 97
cleaning the terminal 87
connection cable 28, 29

E

enabling switches
control relay 17

F

Firmware Configuration
Main 74

H

handling the terminal 20, 21, 88
hardware description 11

J

junction box
connecting MobileView terminal 36
wiring diagram 38

K

keypad 12
keypad description 12

M

mounting bracket
plate dimensions 32, 33

P

PC card slot
inserting PC card 13
power supply 17, 44

S

Setup menu
Firmware Configuration 74
Firmware Update 58

T

technical support 91
terminal
cleaning 87
connecting to junction box 36
handling 20, 21, 88
troubleshooting 89, 90
troubleshooting operating problems 89, 90

V

virtual key codes, Windows 12

Notes:

Notes:

Notes:

Rockwell Automation Support

Use the following resources to access support information.

Technical Support Center	Knowledgebase Articles, How-to Videos, FAQs, Chat, User Forums, and Product Notification Updates.	https://rockwellautomation.custhelp.com/
Local Technical Support Phone Numbers	Locate the phone number for your country.	http://www.rockwellautomation.com/global/support/get-support-now.page
Direct Dial Codes	Find the Direct Dial Code for your product. Use the code to route your call directly to a technical support engineer.	http://www.rockwellautomation.com/global/support/direct-dial.page
Literature Library	Installation Instructions, Manuals, Brochures, and Technical Data.	http://www.rockwellautomation.com/global/literature-library/overview.page
Product Compatibility and Download Center (PCDC)	Get help determining how products interact, check features and capabilities, and find associated firmware.	http://www.rockwellautomation.com/global/support/pcdc.page

Documentation Feedback

Your comments will help us serve your documentation needs better. If you have any suggestions on how to improve this document, complete the How Are We Doing? form at http://literature.rockwellautomation.com/idc/groups/literature/documents/du/ra-du002_-en-e.pdf.

Rockwell Automation maintains current product environmental information on its website at <http://www.rockwellautomation.com/rockwellautomation/about-us/sustainability-ethics/product-environmental-compliance.page>.

Allen-Bradley, FactoryTalk, Guardmaster, MobileView, On-Machine, Rockwell Automation, and Rockwell Software are trademarks of Rockwell Automation, Inc.

Trademarks not belonging to Rockwell Automation are property of their respective companies.

Rockwell Otomasyon Ticaret A.Ş., Kar Plaza İş Merkezi E Blok Kat:6 34752 İçerenköy, İstanbul, Tel: +90 (216) 5698400

www.rockwellautomation.com

Power, Control and Information Solutions Headquarters

Americas: Rockwell Automation, 1201 South Second Street, Milwaukee, WI 53204-2496 USA, Tel: (1) 414.382.2000, Fax: (1) 414.382.4444

Europe/Middle East/Africa: Rockwell Automation NV, Pegasus Park, De Kleetlaan 12a, 1831 Diegem, Belgium, Tel: (32) 2 663 0600, Fax: (32) 2 663 0640

Asia Pacific: Rockwell Automation, Level 14, Core F, Cyberport 3, 100 Cyberport Road, Hong Kong, Tel: (852) 2887 4788, Fax: (852) 2508 1846

Publication 2711T-UM001D-EN-P - June 2018

Supersedes Publication 2711T-UM001C-EN-P - May 2017

Copyright © 2018 Rockwell Automation, Inc. All rights reserved. Printed in the U.S.A.