

# EtherNet/IP Network Configuration

## EtherNet/IP Communication Modules

1756-ENBT, 1756-EN2F, 1756-EN2T, 1756-EN2TR, 1756-EN2TXT, 1756-EN3TR, 1756-EN2TSC, 1756-EN2TRXT, 1756-EWEB, 1768-ENBT

## CompactLogix Controllers

1769-L23E-QB1B, 1769-L23E-QBFC1B, 1769-L32E, 1769-L35E, CompactLogix 5370

## EtherNet/IP Adapters

1734-AENT, 1734-AENTR, 1769-AENTR, 1783-ETAP, 1783-ETAP1F, 1783-ETAP2F, 1794-AENT, 20-Comm-E, 22-COMM-E



## Important User Information

Read this document and the documents listed in the additional resources section about installation, configuration, and operation of this equipment before you install, configure, operate, or maintain this product. Users are required to familiarize themselves with installation and wiring instructions in addition to requirements of all applicable codes, laws, and standards.

Activities including installation, adjustments, putting into service, use, assembly, disassembly, and maintenance are required to be carried out by suitably trained personnel in accordance with applicable code of practice.

If this equipment is used in a manner not specified by the manufacturer, the protection provided by the equipment may be impaired.

In no event will Rockwell Automation, Inc. be responsible or liable for indirect or consequential damages resulting from the use or application of this equipment.

The examples and diagrams in this manual are included solely for illustrative purposes. Because of the many variables and requirements associated with any particular installation, Rockwell Automation, Inc. cannot assume responsibility or liability for actual use based on the examples and diagrams.

No patent liability is assumed by Rockwell Automation, Inc. with respect to use of information, circuits, equipment, or software described in this manual.

Reproduction of the contents of this manual, in whole or in part, without written permission of Rockwell Automation, Inc., is prohibited.

Throughout this manual, when necessary, we use notes to make you aware of safety considerations.



**WARNING:** Identifies information about practices or circumstances that can cause an explosion in a hazardous environment, which may lead to personal injury or death, property damage, or economic loss.



**ATTENTION:** Identifies information about practices or circumstances that can lead to personal injury or death, property damage, or economic loss. Attentions help you identify a hazard, avoid a hazard, and recognize the consequence.

---

### IMPORTANT

Identifies information that is critical for successful application and understanding of the product.

---

Labels may also be on or inside the equipment to provide specific precautions.



**SHOCK HAZARD:** Labels may be on or inside the equipment, for example, a drive or motor, to alert people that dangerous voltage may be present.



**BURN HAZARD:** Labels may be on or inside the equipment, for example, a drive or motor, to alert people that surfaces may reach dangerous temperatures.



**ARC FLASH HAZARD:** Labels may be on or inside the equipment, for example, a motor control center, to alert people to potential Arc Flash. Arc Flash will cause severe injury or death. Wear proper Personal Protective Equipment (PPE). Follow ALL Regulatory requirements for safe work practices and for Personal Protective Equipment (PPE).

---

## Summary of Changes

---

This manual contains new and updated information. Changes throughout this revision are marked by change bars, as shown to the right of this paragraph. ■

Topic	Page
Simplified the list of Catalog Numbers	Front Cover
Updated the section Communicate with the Socket Object via a MSG Instruction, to refer to the publication EtherNet/IP Socket Interface Application Technique, ENET-AT002.	59
Under Logix5000™ Controller Combinations, updated Table 19 - Choosing a Communication Module with a 1769 CompactLogix™ 5370 Controller entry, and added 1756-EWEB to the ControlLogix® and 1768 CompactLogix entries.	84

**Notes:**

<b>Preface</b>	Studio 5000 Environment . . . . .	9
	Additional Resources . . . . .	10
	<b>Chapter 1</b>	
<b>EtherNet/IP Overview</b>	EtherNet/IP Communication Modules in a Control System . . . . .	11
	<b>Chapter 2</b>	
<b>Configure a Workstation to Operate on an EtherNet/IP Network</b>	Configure the Ethernet Communication Driver in RSLinx Software . . . . .	14
	<b>Chapter 3</b>	
<b>Configure an EtherNet/IP Communication Module to Operate on the Network</b>	Determine Network Parameters . . . . .	17
	Set the Network IP Address on a Module . . . . .	18
	Set the Network IP Address with the Rotary Switches . . . . .	19
	Set the Network IP Address with the BOOTP/DHCP Server . . . . .	20
	Set the Network IP Address with RSLinx Software or the Studio 5000 Environment . . . . .	23
	Reset the Module IP Address to Factory Default Value . . . . .	27
	Duplicate IP Address Detection . . . . .	27
	Duplicate IP Address Resolution . . . . .	28
	IP Address Swapping . . . . .	28
	DNS Addressing . . . . .	29
	Use EtherNet/IP Communication Modules in a Logix5000 Controller Application . . . . .	30
	Electronic Keying . . . . .	30
	More Information . . . . .	31
	Device-level Ring Network . . . . .	31
	<b>Chapter 4</b>	
<b>Control I/O</b>	Set Up the Hardware . . . . .	33
	Add Distributed I/O . . . . .	34
	Add an I/O Module . . . . .	35
	Select a Communication Format . . . . .	37
	Choosing a Direct or Rack-optimized Connection . . . . .	37
	Ownership . . . . .	41
	Select a Remote Adapter . . . . .	42
	Set the Requested Packet Interval (RPI) . . . . .	43
	Access Distributed I/O . . . . .	44
	<b>Chapter 5</b>	
<b>Interlocking and Data Transfer between Controllers</b>	Set Up the Hardware . . . . .	48
	Tag Guidelines for Produced or Consumed Data . . . . .	49
	Terminology . . . . .	49
	Connections for Produced and Consumed Tags . . . . .	50

Produce a Tag.....	51
Configure the Produced Tag.....	51
Consume Data Produced by Another Controller.....	53
Add the Producer Controller to the Consumer's	
I/O Configuration.....	53
Create the Consumed Tag.....	55
Guidelines for Message (MSG) Instructions .....	58
Connections for Messages.....	59
Cache Message Connections.....	59
Communicate with the Socket Object via a MSG Instruction .....	59
ENTER Message Logic .....	60
Add the EtherNet/IP Communication Module to the Local	
Controller's I/O Configuration.....	60
Enter a Message .....	62
Configure a MSG Instruction .....	63
Communicate with PLC-5 or SLC Controllers .....	67
Converting between INTs and DINTs .....	67
Mapping Tags .....	68
Receive MSGs from PLC-5 or SLC 500 Controllers .....	70

## Chapter 6

### Send Email

EtherNet/IP Communication Module as an Email Client .....	71
Send Email via a Controller-initiated Message Instruction .....	73
Create String Tags .....	73
Enter the Ladder Logic.....	76
Configure the MSG Instruction that Identifies	
the Mail Relay Server.....	76
Configure the MSG Instruction That Contains the Email Text... ..	78
Enter Email Text .....	80
Possible Email Status Codes .....	80

## Chapter 7

### Communicate with PanelView Terminals

Set Up the Hardware .....	83
Logix5000 Controller Combinations.....	84
Connections to PanelView Terminals.....	84
Add a PanelView Terminal.....	85
Organize Controller Data for a PanelView Terminal .....	89
Connections to FactoryTalk View Applications.....	89

## Chapter 8

### Diagnostic Web Pages

Access Web Browser Support.....	92
1756-EN2TR Module .....	93
Diagnostic Overview Page .....	93
Ethernet Statistics Web Page .....	95
Connection Manager Cmd Object Info Web Page.....	96
Ring Statistics Web Page .....	97

	1756-ENBT Module .....	98
	Diagnostic Overview Page.....	98
	Ethernet Statistics .....	100
	1769-AENTR Adapter .....	101
	Diagnostic Overview Page.....	101
	Ethernet Statistics .....	103
	 <b>Appendix A</b>	
<b>History of Changes</b>	ENET-UM001M-EN-P, November 2014.....	107
	ENET-UM001L-EN-P, March 2014.....	108
	ENET-UM001K-EN-P, February 2013.....	108
	ENET-UM001J-EN-P, May 2011.....	108
	ENET-UM001I-EN-P, January 2010.....	108
	ENET-UM001H-EN-P, September 2009.....	108
	ENET-UM001G-EN-P, November 2008.....	109
	ENET-UM001F-EN-P, November 2006 .....	109
	ENET-UM001E-EN-P, January 2006 .....	109
	ENET-UM001D-EN-P, July 2005 .....	109
	ENET-UM001C-EN-P, October 2004 .....	109
	ENET-UM001B-EN-P, June 2004 .....	110
 <b>Index</b>	.....	111

**Notes:**



This manual describes how you can use EtherNet/IP communication modules with your Logix5000 controller and communicate with various devices on the Ethernet network.

Use this manual if you program applications that use EtherNet/IP networks with these Logix5000 controllers:

- CompactLogix controller
- ControlLogix controller
- SoftLogix™ controller

Be sure to understand these concepts and tools:

- Use of networking
- Studio 5000® environment
- RSLinx® Classic software
- RSNetWorx™ for EtherNet/IP software

## Studio 5000 Environment

The Studio 5000 Automation Engineering & Design Environment™ combines engineering and design elements into a common environment. The first element in the Studio 5000 environment is the Logix Designer application. The Studio 5000 Logix Designer® application is the rebranding of RSLogix™ 5000 software and will continue to be the product to program Logix5000 controllers for discrete, process, batch, motion, safety, and drive-based solutions.

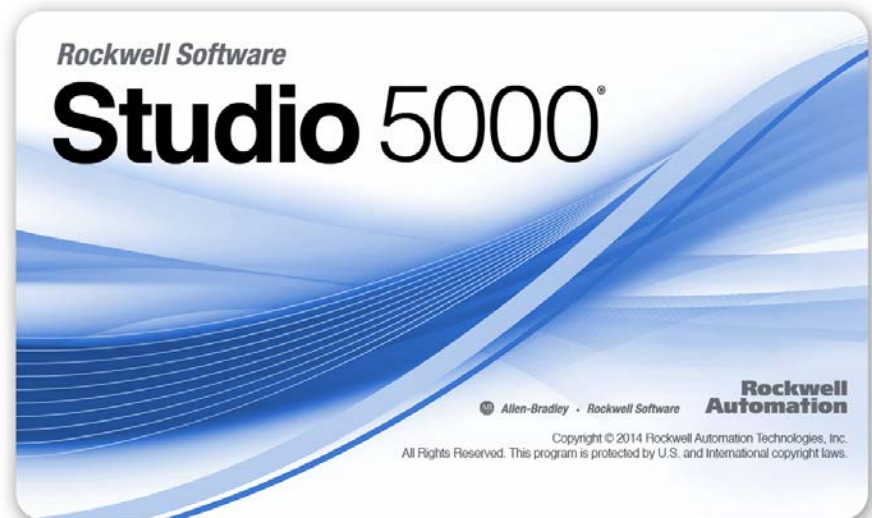

The Studio 5000 environment is the foundation for the future of Rockwell Automation® engineering design tools and capabilities. This environment is the one place for design engineers to develop all of the elements of their control system.

## Additional Resources

These documents contain additional information concerning related products from Rockwell Automation.

Resource	Description
EtherNet/IP Communication Modules Installation Instructions, publication <a href="#">ENET-IN002</a>	Provides information about how to complete these tasks with EtherNet/IP communication modules in a Logix5000 control system: <ul style="list-style-type: none"> <li>• Install the module</li> <li>• Configure initial application setup</li> <li>• Troubleshoot application anomalies related to EtherNet/IP communication module use</li> </ul>
EtherNet/IP Media Planning and Installation Manual This manual is available from the Open DeviceNet Vendor Association (ODVA) at: <a href="http://www.odva.org">http://www.odva.org</a> .	Provides details about how to install, configure, and maintain linear and Device-level Ring (DLR) networks by using Rockwell Automation EtherNet/IP devices equipped with embedded switch technology.
EtherNet/IP Secure Communication Module User Manual, publication <a href="#">ENET-UM003</a>	Provides information on setting up authentication, encryption, and firewalls, typical architectures, and diagnostics for modules equipped with secure communication functionality.
Ethernet Design Considerations Reference Manual, publication <a href="#">ENET-RM002</a>	Provides details about how to use EtherNet/IP communication modules with Logix5000 controllers and communicate with other devices on the EtherNet/IP network.
EtherNet/IP Socket Interface Application Technique, publication <a href="#">ENET-AT002</a>	Describes the socket interface that you can use to program MSG instructions to communicate between a Logix5000 controller via an EtherNet/IP module and Ethernet devices that do not support the EtherNet/IP application protocol, such as bar code scanners, RFID readers, or other standard Ethernet devices.
EtherNet/IP Embedded Switch Technology Application Guide, publication <a href="#">ENET-AP005</a>	Provides details about how to install, configure, and maintain linear and Device-level Ring (DLR) networks by using Rockwell Automation EtherNet/IP devices equipped with embedded switch technology.
Troubleshoot EtherNet/IP Networks, publication <a href="#">ENET-AT003</a>	Provides details about how to assign IP addresses to and how to troubleshoot EtherNet/IP networks and devices.

You can view or download publications at <http://www.rockwellautomation.com/literature/>. To order paper copies of technical documentation, contact your local Allen-Bradley distributor or Rockwell Automation sales representative.

## EtherNet/IP Overview

EtherNet/IP networks are communication networks that offer a comprehensive suite of messages and services for many automation applications.

These are examples of applications that use EtherNet/IP networks:

- Real Time Control
- Time Synchronization
- Motion

This open network standard uses off-the-shelf Ethernet communication products to support real-time I/O messaging, information exchange, and general messaging.

EtherNet/IP networks also support CIP Safety, making the simultaneous transmission of safety and standard control data and diagnostics information over a common network possible.

### EtherNet/IP Communication Modules in a Control System

Depending on the type, Rockwell Automation EtherNet/IP communication modules provide some of this functionality:

- Support for messaging, produced/consumed tags, and distributed I/O
- Encapsulate messages within standard TCP/UDP/IP protocol
- Share a common application layer with ControlNet and DeviceNet network protocols
- Interface via RJ45, category 5, unshielded, twisted-pair cable connectors
- Fiber connectors
- Support for half/full duplex 10 Mbps or 100 Mbps operation
- No network scheduling or routing table requirements

This graphic shows how Rockwell Automation EtherNet/IP communication modules fit into a control system.

**Figure 1 - EtherNet/IP Communication Modules in a Control Systems**

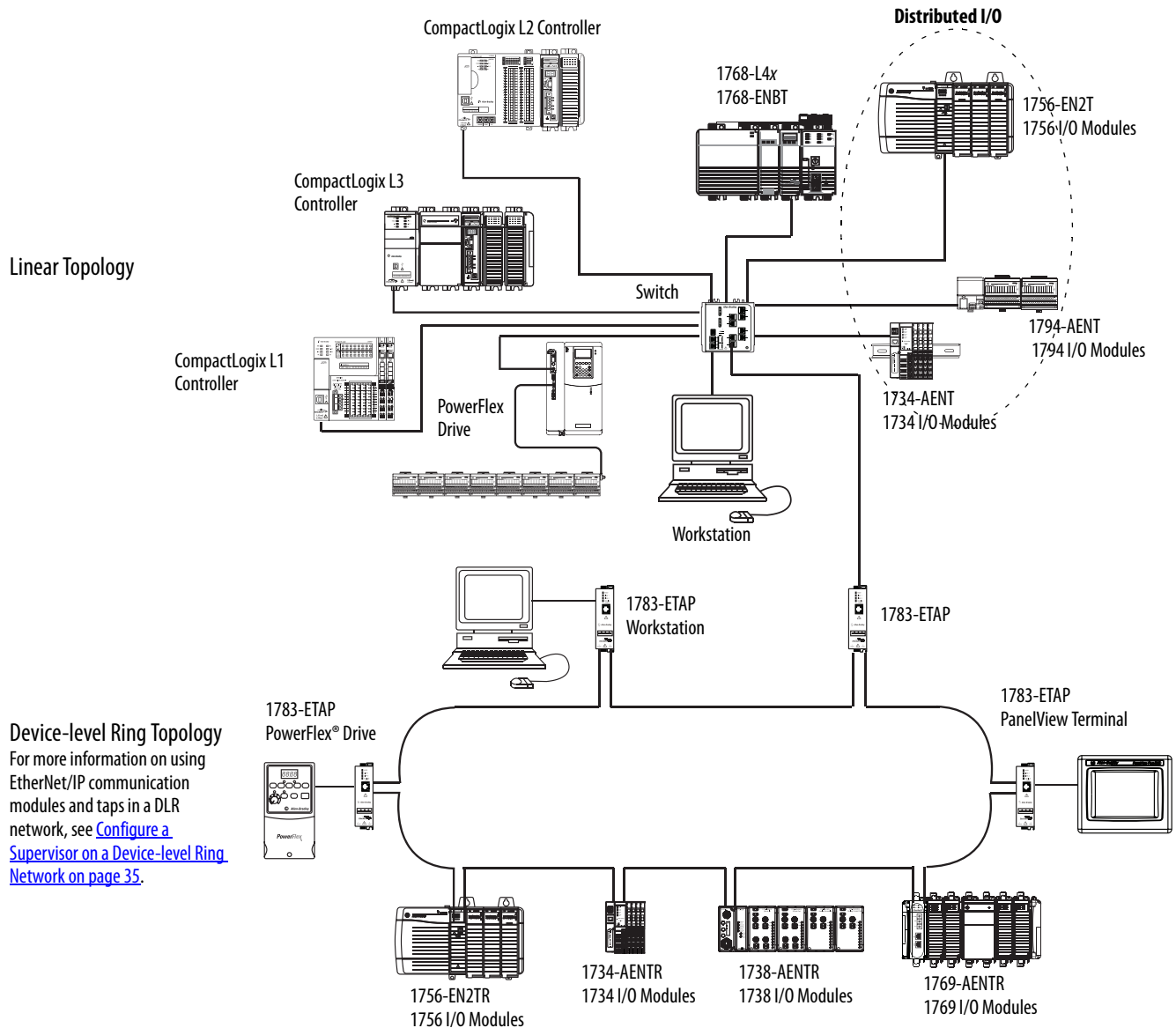

**Device-level Ring Topology**  
 For more information on using EtherNet/IP communication modules and taps in a DLR network, see [Configure a Supervisor on a Device-level Ring Network on page 35](#).

In this example, these actions can occur over the EtherNet/IP network:

- Controllers produce and consume tags.
- Controllers initiate MSG instructions that send and receive data or configure devices.
- Workstations upload or download projects to the controllers

# Configure a Workstation to Operate on an EtherNet/IP Network

This chapter describes how to configure a workstation to operate on an EtherNet/IP network.

You must configure an Ethernet communication driver in RSLinx software for the workstation.

A workstation needs the driver to perform these tasks:

- Upload and download Studio 5000 environment project information to controllers over an EtherNet/IP network.
- Configure EtherNet/IP network parameters for devices via RSNetWorx for EtherNet/IP software.
- Collect controller data for electronic operator interfaces, for example, PanelView™ Plus terminals, and visualization software, for example, FactoryTalk® View software.

You can choose either of these Ethernet drivers:

- AB\_ETHIP
- AB\_ETH

Before you add a new driver, confirm these conditions exist:

- Workstation is properly connected to the EtherNet/IP network
- IP address and other network parameters are correctly configured for the workstation

## Configure the Ethernet Communication Driver in RSLinx Software

To configure the EtherNet/IP driver, follow these steps.

1. From the Communications menu, choose Configure Drivers.

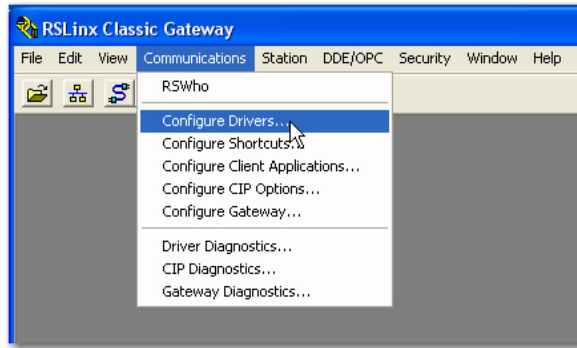

The Configure Drivers dialog box appears.

2. From the Available Driver Types pull-down menu, choose EtherNet/IP Driver or Ethernet devices and click Add New.

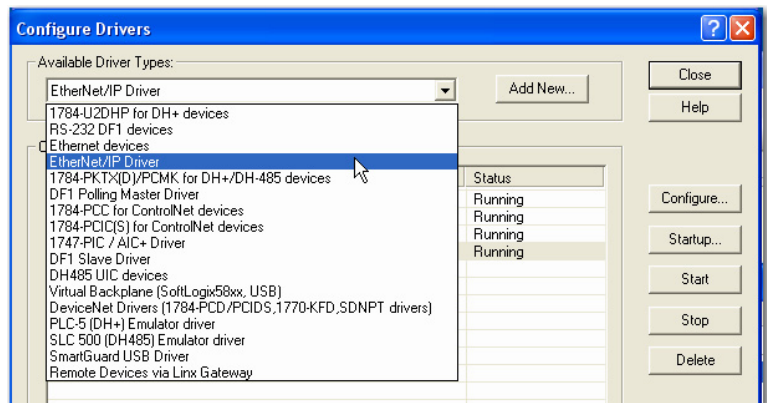

The Add New RSLinx Driver dialog box appears.

3. Type a name for the new driver and click OK.

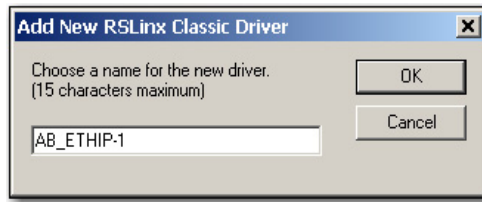

The Configure driver dialog box appears.

4. Click Browse Local Subnet.

**TIP** To view devices on a different subnet or VLAN from the workstation running RSLinx software, click Browse Remote Subnet.

5. Click OK to close the dialog box.

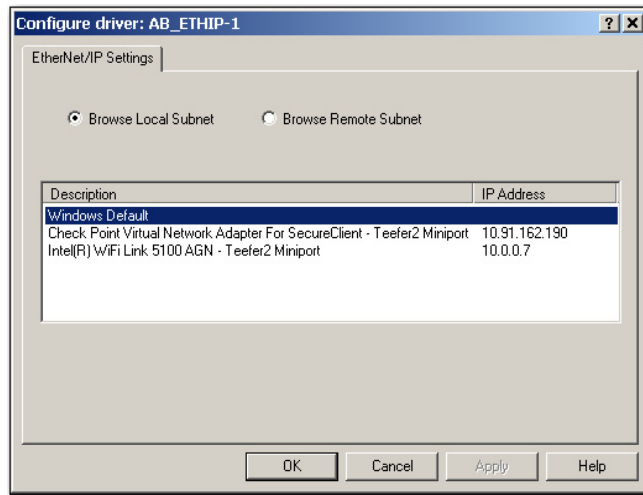

This new driver is available.

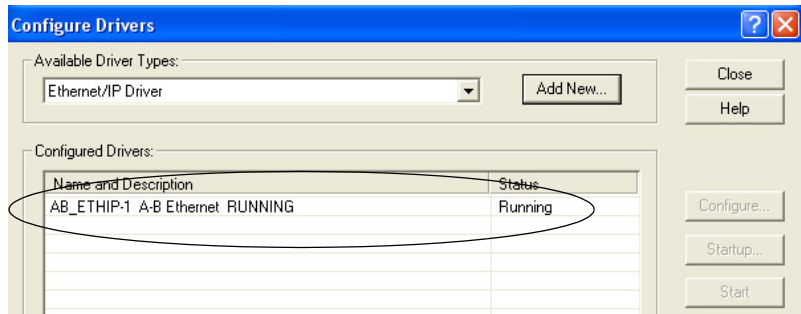

**Notes:**



## Configure an EtherNet/IP Communication Module to Operate on the Network

This chapter describes how to configure an EtherNet/IP communication module to operate on an EtherNet/IP network.

Topic	Page
Determine Network Parameters	17
Set the Network IP Address on a Module	18
Duplicate IP Address Detection	27
IP Address Swapping	28
DNS Addressing	29
Use EtherNet/IP Communication Modules in a Logix5000 Controller Application	30

### Determine Network Parameters

To operate an EtherNet/IP network, you must define these parameters.

EtherNet/IP Network Parameter	Description
IP address	<p>The IP address uniquely identifies the module. The IP address is in the form <i>xxx.xxx.xxx.xxx</i> where each <i>xxx</i> is a number from 000 . . .254.</p> <p>There are some reserved values that you <b>cannot use as the first octet</b> in the address. These numbers are <b>examples</b> of values you cannot use:</p> <ul style="list-style-type: none"> <li>• 001.<i>xxx.xxx.xxx</i></li> <li>• 127.<i>xxx.xxx.xxx</i></li> <li>• 223 to 255.<i>xxx.xxx.xxx</i></li> </ul> <p>The specific reserved values that cannot be used vary according the conditions of each application. The previous values are only examples of reserved values.</p>
Subnet mask	<p>Subnet addressing is an extension of the IP address scheme that allows a site to use a single network ID for multiple physical networks. Routing outside of the site continues by dividing the IP address into a net ID and a host ID via the class. Inside a site, the subnet mask is used to redivide the IP address into a custom network ID portion and host ID portion. This field is set to 0.0.0.0 by default.</p> <p>If you change the subnet mask of an already-configured module, you must cycle power to the module for the change to take effect.</p>
Gateway	<p>A gateway connects individual physical networks into a system of networks. When a node needs to communicate with a node on another network, a gateway transfers the data between the two networks. This field is set to 0.0.0.0 by default.</p>

If you use DNS addressing, or reference the module via host name in MSG instructions, define these parameters.

**Table 1 - EtherNet/IP Network Parameters for DNS Addressing**

EtherNet/IP Network Parameter	Description
Host name	A host name is part of a text address that identifies the host for a module. The full text address of a module is <i>host_name.domain_name</i> .
Domain name	A domain name is part of a text address that identifies the domain in which the module resides. The full text address of a module is <i>host_name.domain_name</i> . The domain name has a 48-character limit. If you specify a DNS server, you must type a domain name. Also, if you send email from the module, some mail relay servers require a domain name during the initial handshake of the SMTP session.
Primary DNS server address	This identifies any DNS servers used in the network. You must have a DNS server configured if you specified a domain name or a host name in the module's configuration. The DNS server converts the domain name or host name to an IP address that can be used by the network. For more information on DNS addressing, see <a href="#">page 29</a> .
Secondary DNS server address	

Check with your Ethernet network administrator to determine if you need to specify these parameters.

## Set the Network IP Address on a Module

Depending on the EtherNet/IP communication module, you can use some or all of these tools to set the network Internet Protocol (IP) address:

- Rotary switches - Switches are physical parts on the module. Remember the following as you read this chapter:
  - Some EtherNet/IP communication modules use thumbwheel switches. that function similarly to rotary switches. This chapter uses the term rotary switches to describe both switch types.
  - Some EtherNet/IP communication modules do not have rotary switches. If your module does not have switches, skip Set the Network IP Address with the Rotary Switches on [page 19](#) and go to Set the Network IP Address with the BOOTP/DHCP Server on [page 20](#).
  - 1783-ETAPx EtherNet/IP taps use DIP switches to set the network IP address. For more information on how to use the DIP switches, see the publications for those products.
- Bootstrap Protocol (BOOTP)/Dynamic Host Configuration Protocol (DHCP) server
- RSLinx Classic software
- Studio 5000 environment

The module uses these tools sequentially to set the IP address.

EtherNet/IP communication modules are shipped with this configuration:

- BOOTP/DHCP enabled
- Rotary switches set to 999 - when applicable

If you need to reset your module's settings to its factory default settings during normal module operation, [Reset the Module IP Address to Factory Default Value on page 27](#).

The tools are used in this sequence to set the network IP address:

1. [Set the Network IP Address with the Rotary Switches](#)
2. [Set the Network IP Address with the BOOTP/DHCP Server](#)
3. [Set the Network IP Address with RSLinx Software or the Studio 5000 Environment](#)

## Set the Network IP Address with the Rotary Switches

This graphic shows the rotary switches on a 1756 EtherNet/IP communication module. The location of the switches is dependant on the module.



At powerup, the module reads the rotary switches to determine if they are set to a valid number for the last portion of the IP address. Valid numbers range from 001...254.

If the settings are a valid number, these conditions result:

- IP address = 192.168.1.xxx (where xxx represents the switch settings)
- Subnet mask = 255.255.255.0
- Gateway address = 0.0.0.0

**TIP** Some modules now provide a gateway address of 192.168.1.1 when the network address is set with rotary switches. Refer to the product documentation to determine the correct gateway address the module uses.

- The module does not have a host name assigned, nor does it use any Domain Name System

We recommend that you set the rotary switches to a valid number before installing the module.

If either of these conditions exist, the module attempts to use the BOOTP/DHCP server to set the IP address:

- Rotary switches are not set to a valid number
- Module does not have rotary switches

For more information on using the BOOTP/DHCP server to set the IP address, see [page 20](#).

## Set the Network IP Address with the BOOTP/DHCP Server

The BOOTP/DHCP server is a standalone server you can use to set an IP address. When used, the BOOTP/DHCP server sets an IP address and other Transport Control Protocol (TCP) parameters.

You can use the BOOTP/DHCP server to set the module's IP address if one of these conditions exists at powerup:

- The module's rotary switches are not set to a number and the module is BOOTP/DHCP enabled.
- The module does not have rotary switches and the module is BOOTP/DHCP enabled.

Access the BOOTP/DHCP server from one of these locations:

- Programs > Rockwell Software > BOOTP-DHCP Server

If you have not installed the server, you can download and install it from <http://www.ab.com/networks/ethernet/bootp.html>.

- Tools directory on the Studio 5000 environment installation CD

---

**IMPORTANT** Before you start the BOOTP/DHCP server, make sure you have the module's hardware (MAC) address. The hardware address is on a sticker on the side of the communication module and uses an address in a format similar to the following:

00-00-BC-14-55-35

---

To set the module's IP address with a BOOTP/DHCP server, follow these steps.

1. Start the BOOTP/DHCP software.
2. From the Tools menu, choose Network Settings.

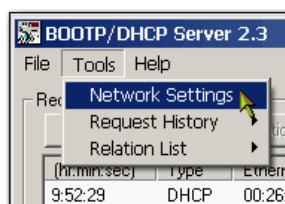

3. Type the Subnet Mask of the network.

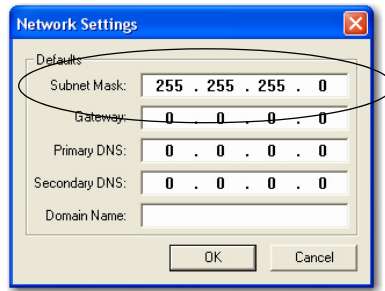

The Gateway address, Primary and/or Secondary DNS address, and Domain Name fields are optional.

4. Click OK.

The Request History panel appears with the hardware addresses of all modules issuing BOOTP requests.

5. Select the appropriate module.

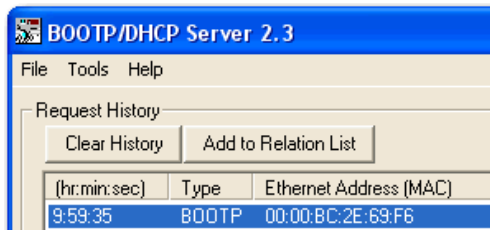

6. Click Add to Relation List.

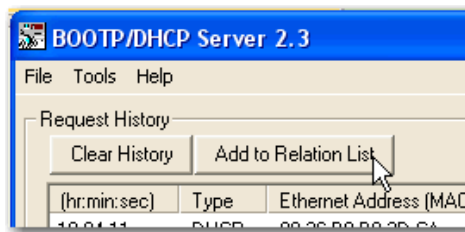

The New Entry dialog box appears.

7. Type an IP Address, Hostname, and Description for the module.

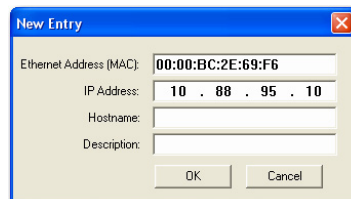

8. Click OK.

9. To permanently assign this configuration to the module, wait for the module to appear in the Relation List panel and select it.
10. Click Disable BOOTP/DHCP.

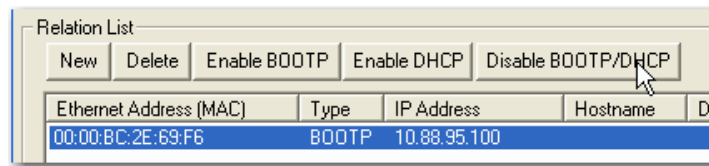

When power is recycled, the module uses the assigned configuration and does not issue a BOOTP request.

---

**IMPORTANT** If you do not click Disable BOOTP/DHCP, on a power cycle, the host controller clears the current IP configuration and begins sending BOOTP requests again.

---

### Use DHCP Software

Dynamic Host Configuration Protocol (DHCP) software automatically assigns IP addresses to client stations logging onto a TCP/IP network. DHCP is based on BOOTP and maintains some backward compatibility. The main difference is that BOOTP allows for manual configuration (static), while DHCP allows for both static and dynamic allocation of network addresses and configurations to newly attached modules.

Be cautious when using DHCP software to configure a module. A BOOTP client, such as the EtherNet/IP communication modules, can start from a DHCP server only if the DHCP server is specifically written to also handle BOOTP queries. This is specific to the DHCP software package used. Consult your system administrator to see if a DHCP package supports BOOTP commands and manual IP allocation.



---

**ATTENTION:** The EtherNet/IP communication module must be assigned a fixed network address. The IP address of this module must not be dynamically provided.

Failure to observe this precaution may result in unintended machine motion or loss of process control.

---

## Set the Network IP Address with RSLinx Software or the Studio 5000 Environment

This table describes when to set the network IP address with RSLinx software or the Studio 5000 environment.

Conditions	Software to Use	Page
<ul style="list-style-type: none"> <li>A BOOTP server is not available</li> <li>The EtherNet/IP communication module is connected to another NetLinx network</li> </ul>	RSLinx software	24
The Studio 5000 Logix Designer project is online with a controller that communicates to or through the EtherNet/IP communication module	Studio 5000 environment	26

Consider these factors when you determine how to set the network IP address:

- Network isolation from or integration into the plant/enterprise network
- Network size - For large networks, isolated networks, it might be more convenient and safer to use a BOOTP/DHCP server rather than the Studio 5000 Environment or RSLinx software. The BOOTP/DHCP server also limits the possibility of assigning duplicate IP addresses.
- Company policies and procedures dealing with plant floor network installation and maintenance
- Level of involvement by IT personnel in plant-floor network installation and maintenance
- Type of training offered to control engineers and maintenance personnel

If you use the Rockwell Automation BOOTP or DHCP server in an uplinked subnet where an enterprise DHCP server exists, a module may get an address from the enterprise server before the Rockwell Automation utility even sees the module. You might have to disconnect from the uplink to set the address and configure the module to retain its static address before reconnecting to the uplink. This is not a problem if you have node names configured in the module and leave DHCP enabled.

### Set the Network IP Address with RSLinx Software

To use RSLinx software to set the communication module's IP address, follow these steps.

1. From the Communications menu, choose RSWho.

The RSWho dialog box appears.

2. Navigate to the Ethernet network.
3. Right-click the EtherNet/IP module and choose Module Configuration.

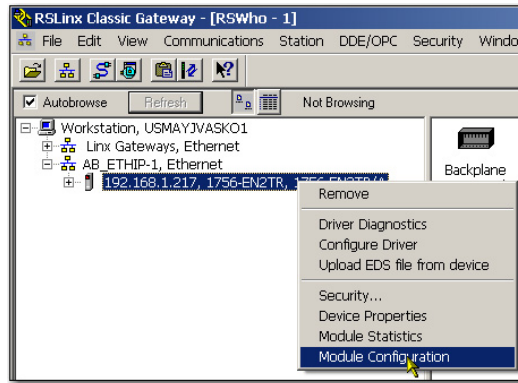

The Module Configuration dialog box appears.

4. Click the Port Configuration tab.

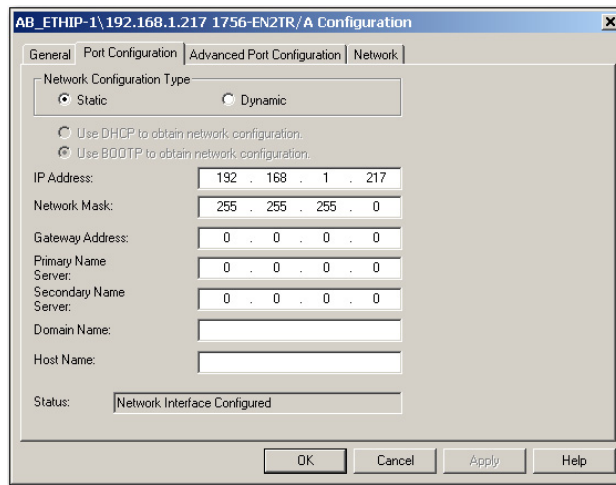

5. For Network Configuration Type, click Static to permanently assign this configuration to the port.

---

**IMPORTANT** If you click Dynamic, on a power cycle, the controller clears the current IP configuration and resumes sending BOOTP requests.

---



6. Type this information in the appropriate fields:
  - In the IP Address field, type the IP address.
  - In the Network Mask field, type the network mask address.
  - In the Gateway Address field, type the gateway address.
  - In the Primary Name Server field, type the name of the primary server.
  - In the Secondary Name Server field, type the name of the secondary server.
  - In the Domain Name field, type the domain name.
  - In the Host Name field, type the host name.

7. Configure the port settings.

To	Then
Use the default port speed and duplex settings	Leave Auto-negotiate port speed and duplex checked. This setting determines the actual speed and duplex setting.
Manually configure your port's speed and duplex settings	Follow these steps. <ol style="list-style-type: none"> <li>1. Clear the Auto-negotiate port speed and duplex checkbox.</li> <li>2. From the Current Port Speed pull-down menu, choose a port speed.</li> <li>3. From the Current Duplex pull-down menu, choose the appropriate Duplex value, that is, Half Duplex or Full Duplex.</li> </ol>

**IMPORTANT** Consider the following when you configure the module's port settings:

- The speed and duplex settings for the ports connected by an Ethernet Cable must match or communication can be impaired.
- If the module is connected to an unmanaged switch, leave Autonegotiate port speed and duplex checked or communication can be impaired.
- If you force the port speed and duplex of a device and it is connected to a managed switch, the corresponding port of the managed switch must be forced to the same settings to avoid communication errors.
- If you connect a manually-configured device to an autonegotiate device (duplex mismatch), a high rate of transmission errors can occur.

8. Click OK.

### Set the Network IP Address with the Studio 5000 Environment

To use the Studio 5000 environment to set the communication module's IP address, follow these steps.

1. In the Controller Organizer, right-click the EtherNet/IP module and choose Properties.

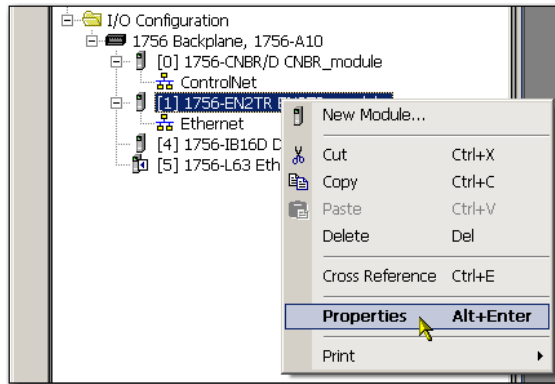

The Module Properties dialog box appears.

2. Click the Port Configuration tab.

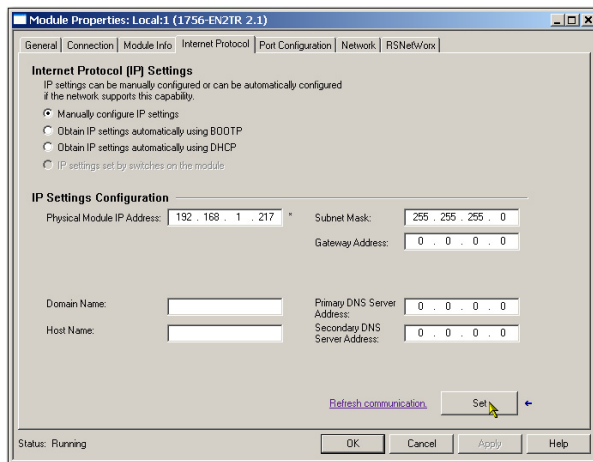

3. In the IP Address field, type the IP address.
4. In the other fields, type the other network parameters, if needed.

---

**IMPORTANT** The fields that appear vary from one EtherNet/IP module to another.

---

5. Click Set.
6. Click OK.

## Reset the Module IP Address to Factory Default Value

You can reset the module's IP address to its factory default value with the following methods:

- If the module has rotary switches, set the switches to 888 and cycle power.
- If the module does not have rotary switches, use a MSG instruction to the reset the IP address.

## Duplicate IP Address Detection

Some EtherNet/IP communication modules support duplicate IP address detection. The module verifies that its IP address does not match any other network device's IP address when you perform either of these tasks:

- Connect the module to a EtherNet/IP network.
- Change the module's IP address.

If the module's IP address matches that of another device on the network, the module's EtherNet/IP port transitions to Conflict mode. In Conflict mode, these conditions exist:

- OK status indicator is blinking red.
- Network (NET) status indicator is solid red.
- On some EtherNet/IP communication modules, the module status display indicates the conflict.

The display scrolls: OK <IP\_address\_of\_this\_module> Duplicate IP <Mac\_address\_of\_duplicate\_node\_detected>

For example: OK 10.88.60.196 Duplicate IP - 00:00:BC:02:34:B4

- On some EtherNet/IP communication modules, the module's diagnostic webpage displays information about duplicate IP address detection.

For more information on which EtherNet/IP communication modules support displaying duplicate IP address on their diagnostic webpage, see the Technical Note titled **Logix modules Duplicate IP address detection enhancement**, #118216, in the Technical Support Knowledgebase available at <http://www.rockwellautomation.com/knowledgebase/>.

## Duplicate IP Address Resolution

When two EtherNet/IP communication modules on a network have conflicting IP addresses, the resolution depends on the conditions in which the duplication is detected. This table describes how duplicate IP addresses are resolved.

Duplicate IP Address Detection Conditions	Resolution Process
<ul style="list-style-type: none"> <li>Both modules support duplicate IP address detection</li> <li>Second module is added to the network after the first module is operating on the network</li> </ul>	<ol style="list-style-type: none"> <li>The module that began operation first uses the IP address and continues to operate without interruption.</li> <li>The module that begins operation second detects the duplication and enters Conflict mode. To assign a new IP address to the module and leave Conflict mode, see <a href="#">Set the Network IP Address on a Module on page 18</a>.</li> </ol>
<ul style="list-style-type: none"> <li>Both modules support duplicate IP address detection</li> <li>Both modules were powered up at approximately the same time</li> </ul>	<p>Both EtherNet/IP devices enter Conflict mode. To resolve this conflict, follow these steps:</p> <ol style="list-style-type: none"> <li>Assign a new IP address to one of the modules by using the methods described in <a href="#">Set the Network IP Address on a Module on page 18</a>.</li> <li>Cycle power to the other module.</li> </ol>
One module supports duplicate IP address detection and a second module does not	<ol style="list-style-type: none"> <li>Regardless of which module obtained the IP address first, the second module, that is, the module that does not support IP address detection, uses the IP address and continues to operate without interruption.</li> <li>The module that supports duplicate IP address detection detects the duplication and enters Conflict mode. To assign a new IP address to the module and leave Conflict mode, see <a href="#">Set the Network IP Address on a Module on page 18</a>.</li> </ol>

Devices experiencing duplicate IP address conditions behave differently depending on whether connections have been established to either of the modules and whether both modules support duplicate IP address detection.

## IP Address Swapping

Some EtherNet/IP communication modules support IP address swapping. This functionality is used in ControlLogix enhanced redundancy systems. During a system switchover, partnered EtherNet/IP communication modules swap IP addresses.

For more information about IP address swapping, see the ControlLogix Enhanced Redundancy System User Manual, publication [1756-UM535](#).

## DNS Addressing

To further qualify a module's address, use DNS addressing to specify a host name for a module, which also includes specifying a domain name and DNS servers. DNS addressing makes it possible to set up similar network structures and IP address sequences under different domains.

DNS addressing is necessary only if you refer to the module by host name, such as in path descriptions in MSG instructions.

To use DNS addressing, follow these steps.

1. Assign a host name to the module.

A network administrator can assign a host name. Valid host names must be IEC-1131-3 compliant.

2. Configure the module's parameters.
3. In addition to the IP address, subnet mask, and gateway address, configure a host name for the module, domain name, and primary/secondary DNS server addresses.

In the DNS server, the host name must match the IP address of the module.

---

**IMPORTANT**

Make sure the DNS enable bit is set.

If you configure your module by using RSLinx software, version 2.41, the enable bit is cleared and DNS addressing will not work. If you configure your module by using the Port Configuration tab in the Studio 5000 environment, the enable bit is set, so DNS addressing will work.

---

4. In the Studio 5000 environment, add the module to the I/O configuration tree.

See [Add an I/O Module on page 35](#).

---

**IMPORTANT** If a child module resides in the same domain as its parent module, just type the host name. If the child module's domain differs from that of its parent module, type the host name and the domain name (host.domain)

---



---

**IMPORTANT** You can also use DNS addressing in a module profile in the I/O controller tree or in a message path. If the destination module's domain name differs from that of the source module, use a fully-qualified DNS name (hostname.domainname). For example, to send a message from ENBT1.location1.companyA to ENTB1.location2.companyA, the host names match, but the domains differ. Without the entry of a fully qualified DNS name, the module adds the default domain name to the specified host name.

---

## Use EtherNet/IP Communication Modules in a Logix5000 Controller Application

After installing an EtherNet/IP communication module and setting its IP address, add the module to the Controller Organizer in a Studio 5000 Environment project. This addition establishes I/O control.

You must download that project to the host controller before operation can begin. When the controller begins operation, it establishes a connection with the EtherNet/IP communication module. The module's configuration determines its behavior.

For more information on connecting a workstation to and configuring it for use on an EtherNet/IP network, see [Configure a Workstation to Operate on an EtherNet/IP Network on page 13](#).

For more information on controlling I/O, see [Control I/O on page 33](#).

## Electronic Keying

Electronic Keying reduces the possibility that you use the wrong device in a control system. It compares the device defined in your project to the installed device. If keying fails, a fault occurs. These attributes are compared.

Attribute	Description
Vendor	The device manufacturer.
Device Type	The general type of the product, for example, digital I/O module.
Product Code	The specific type of the product. The Product Code maps to a catalog number.
Major Revision	A number that represents the functional capabilities of a device.
Minor Revision	A number that represents behavior changes in the device.

The following Electronic Keying options are available.

Keying Option	Description
Compatible Module	Lets the installed device accept the key of the device that is defined in the project when the installed device can emulate the defined device. With Compatible Module, you can typically replace a device with another device that has the following characteristics: <ul style="list-style-type: none"> <li>• Same catalog number</li> <li>• Same or higher Major Revision</li> <li>• Minor Revision as follows:                             <ul style="list-style-type: none"> <li>– If the Major Revision is the same, the Minor Revision must be the same or higher.</li> <li>– If the Major Revision is higher, the Minor Revision can be any number.</li> </ul> </li> </ul>
Disable Keying	Indicates that the keying attributes are not considered when attempting to communicate with a device. With Disable Keying, communication can occur with a device other than the type specified in the project. <p><b>ATTENTION:</b> Be extremely cautious when using Disable Keying; if used incorrectly, this option can lead to personal injury or death, property damage, or economic loss.</p> <p>We <b>strongly recommend</b> that you <b>do not use</b> Disable Keying.</p> <p>If you use Disable Keying, you must take full responsibility for understanding whether the device being used can fulfill the functional requirements of the application.</p>
Exact Match	Indicates that all keying attributes must match to establish communication. If any attribute does not match precisely, communication with the device does not occur.

Carefully consider the implications of each keying option when selecting one.

---

**IMPORTANT** Changing Electronic Keying parameters online interrupts connections to the device and any devices that are connected through the device. Connections from other controllers can also be broken.

If an I/O connection to a device is interrupted, the result can be a loss of data.

---

### More Information

For more detailed information on Electronic Keying, see Electronic Keying in Logix5000 Control Systems Application Technique, publication [LOGIX-AT001](#).

## Device-level Ring Network

A device-level ring (DLR) network is a single-fault-tolerant ring network intended for the interconnection of automation devices without the need for additional switches. The ring topology offers these advantages:

- Media redundancy
- Fast network fault detection and reconfiguration
- Resiliency of a single-fault-tolerant network
- Easy implementation without additional hardware requirements

---

**IMPORTANT** This section summarizes a DLR network. For information on planning, configuring, and monitoring DLR networks, see EtherNet/IP Embedded Switch Technology Application Guide, publication [ENET-AP005](#).

---

A single DLR network can support as many as 50 nodes. A DLR network supports copper connections (maximum of 100 m), fiber-optic connections (maximum of 2 km), or a mix of copper and fiber.

Figure 2 - Example Device-level Ring Topology

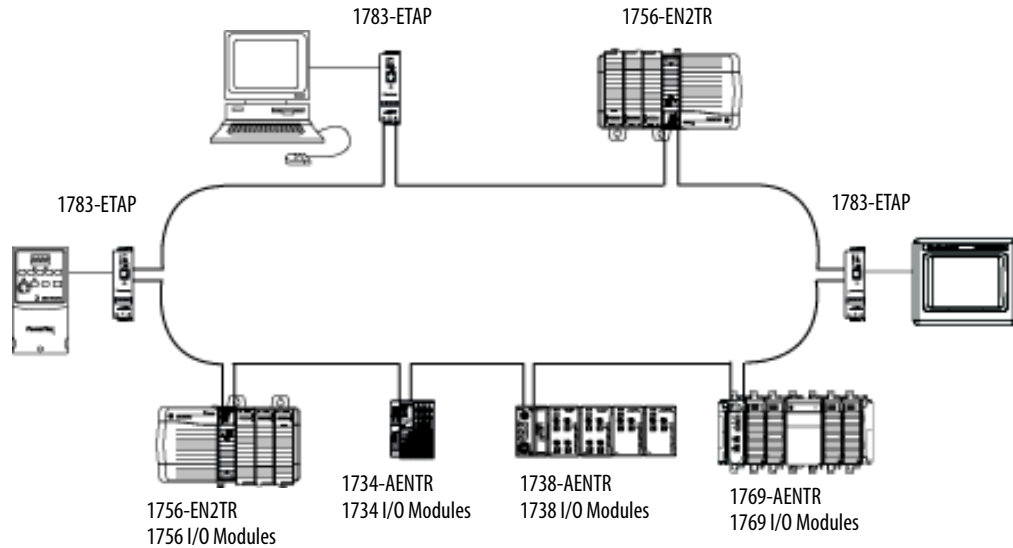

Check your device specifications to determine whether the device supports the DLR network and whether the device can act as a supervisor.

A DLR network is made up of the following nodes.

Node	Description
Supervisor Node	<p>A DLR network requires at least one node to be configured as ring supervisor.</p> <p><b>Important:</b> Out of the box, the supervisor-capable devices have their supervisor function disabled so they are ready to participate in a linear/star network or as a ring node on a DLR network.</p> <p>In a DLR network, you must configure at least one of the supervisor-capable devices as the ring supervisor before physically connecting the ring. If you do not, the DLR network does not work.</p> <p>The ring supervisor provides these main functions:</p> <ul style="list-style-type: none"> <li>• Manages traffic on the DLR network</li> <li>• Collects diagnostic information for the network</li> </ul> <p>We recommend that you do the following:</p> <ul style="list-style-type: none"> <li>• Configure at least one back-up supervisor.</li> <li>• Configure the desired active ring supervisor with a numerically higher precedence value as compared to the back-up supervisors.</li> <li>• Keep track of the DLR network's supervisor-precedence values for all supervisor-enabled nodes.</li> </ul>
Ring Node	<p>A ring node is any node that operates on the network to process data that is transmitted over the network or to pass on the data to the next node on the network. When a fault occurs on the DLR network, the ring nodes reconfigure themselves and relearn the network topology. Additionally, ring nodes can report fault locations to the active ring supervisor.</p>



## Control I/O

This chapter describes how a controller controls distributed I/O over an EtherNet/IP network. An EtherNet/IP communication module connects the controller to the network.

Topic	Page
Set Up the Hardware	33
Select a Remote Adapter	42
Set the Requested Packet Interval (RPI)	43
Access Distributed I/O	44

### Set Up the Hardware

In this example, the Logix5000 controller uses an EtherNet/IP communication module to connect to the EtherNet/IP network. The distributed (remote) I/O uses an EtherNet/IP adapter to connect to the EtherNet/IP network.

**Figure 3 - Distributed I/O over an EtherNet/IP Network**

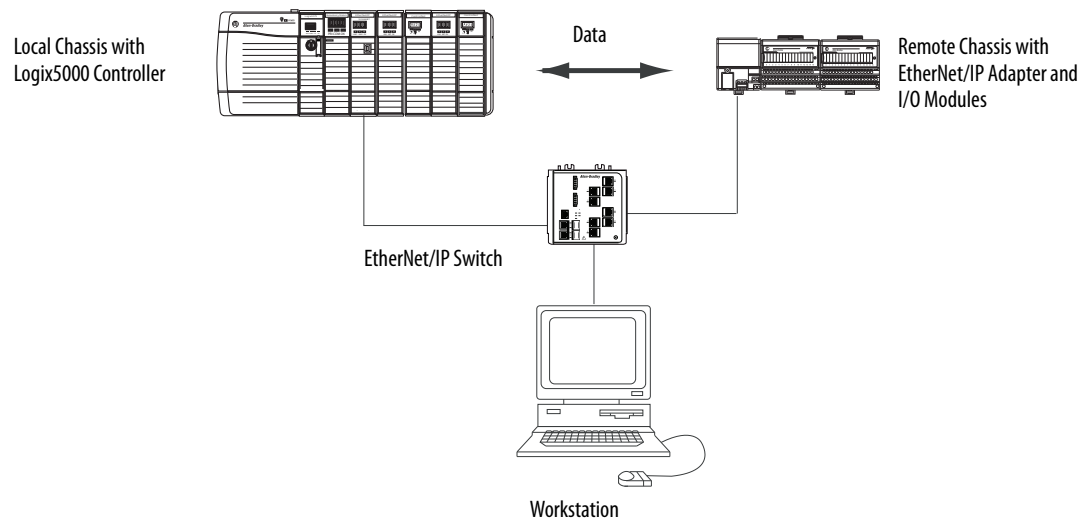

A Logix5000 controller establishes direct or rack-optimized connections to communicate with I/O modules. Digital I/O modules support either connection type, but analog I/O modules support only direct connections.

You must complete these tasks before your controller can communicate with distributed I/O modules over an EtherNet/IP network:

- Set the IP addresses for each EtherNet/IP communication module.
- Connect all wiring and cabling.
- Configure a communication driver (such as AB-ETHIP-1) for the programming workstation.

## Add Distributed I/O

To communicate with distributed I/O modules, add the following components to the controller's I/O Configuration folder:

- Local EtherNet/IP communication module
- Remote adapter
- I/O modules in the same chassis as the remote adapter

Within the folder, organize the modules into a hierarchy (tree/branch, parent/child).

This graphic shows a system that uses a 1756-EN2TR module as the local communication module, a remote 1794-AENT adapter and distributed FLEX™ I/O modules.

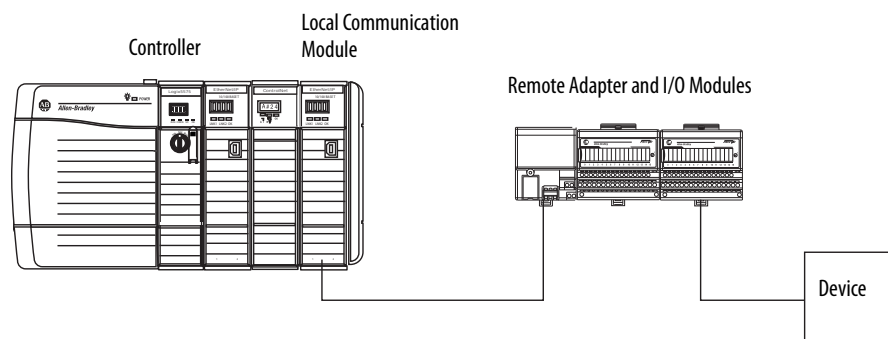

To build the I/O configuration for a typical distributed I/O network, follow these steps.

1. Add the local communication module, that is, the bridge.
2. Add the remote adapter for the distributed I/O chassis or DIN rail.
3. Add the I/O module.

This graphic shows the consumer controller's I/O configuration after distributed I/O modules are added.

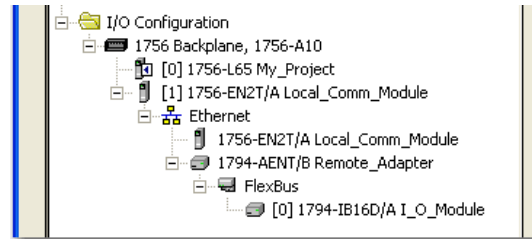

---

**IMPORTANT** I/O is controlled on the same subnet and cannot be processed via a router.

---

## Add an I/O Module

To add a module to the I/O Configuration folder, follow these steps.

1. In the Controller Organizer, right-click the remote communication module and choose New Module.

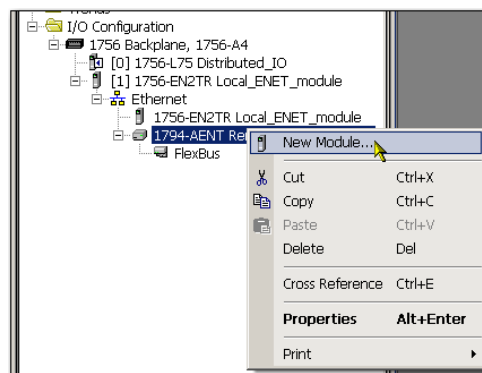

The Select Module dialog box appears.

- Choose the module you wish to add and click OK.

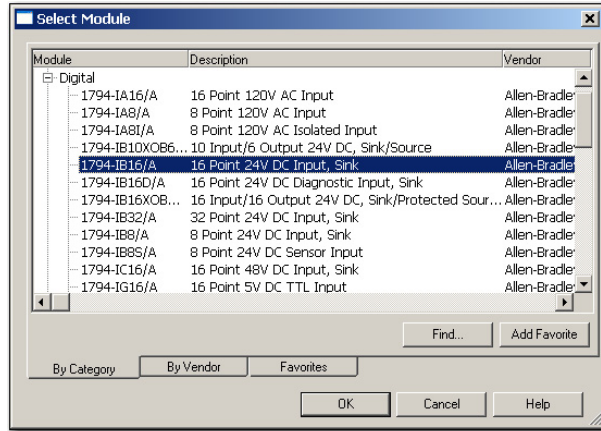

Depending on the I/O module, the Select Major Revision dialog box may appear. If the dialog box appears, choose the module's major revision and click OK.

The Module Properties dialog box appears.

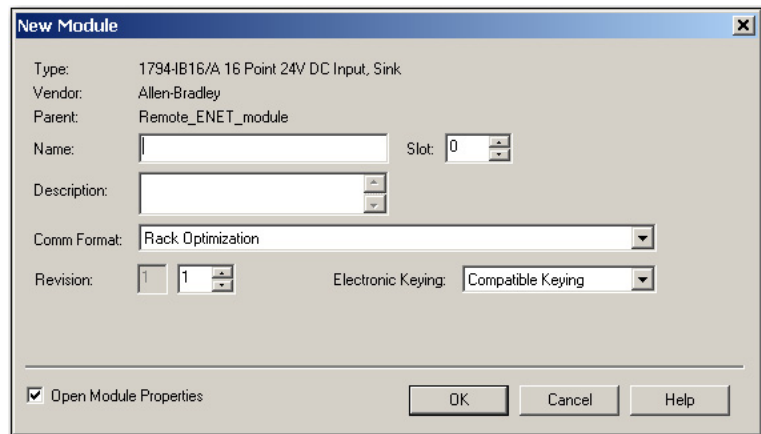

- In the Name field, type the name of your I/O module.
- In the Slot field, type the slot number in which your I/O module will reside.
- From the Comm Format pull-down menu, choose a communication format.

For more information on the selection of communication formats, see [Set the Requested Packet Interval \(RPI\) on page 43](#).

- Click OK to see the rest of the Module Properties dialog box.
- Configure the module as necessary.

Use the Help button to view module-specific configuration information.

- Click Finish.

## Select a Communication Format

When configuring an I/O module, you must select a communication format. The type of communication format determines the data structure for the module's tags. Many I/O modules support different formats. Each format uses a different data structure.

The communication format determines these parameters:

- Direct or rack-optimized connection
- Ownership

**Table 2 - Communication Formats**

I/O Module Type	Desired Connection Type	Required Communication Format
Digital	A rack-optimized connection	Rack Optimization
	To use specialty features of the module, such as diagnostics, timestamps, or electronic fuses	Full Diagnostics CST Timestamped
Digital	A direct connection	Scheduled Data Input Data Output Data
Analog	A direct connection (only direct connection is supported for analog modules)	Float Data Integer Data CST Timestamped

See the Studio 5000 environment online help for specific communication formats per I/O module.

## Choosing a Direct or Rack-optimized Connection

The Logix5000 controller uses connections to transmit I/O data. These connections can be direct connections or rack-optimized connections. The connection types that are available are module-dependant.

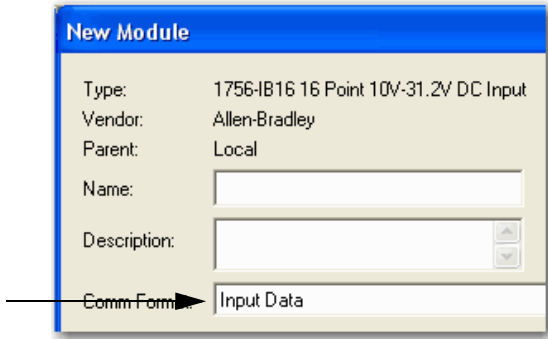
Term	Definition
Direct connection	<p>A direct connection is a real-time, data transfer link between the controller and an I/O module. The controller maintains and monitors the connection with the I/O module. Any break in the connection, such as a module fault or the removal of a module while under power, sets fault bits in the data area associated with the module.</p> <p>A direct connection is any connection that does not use the Rack Optimization Comm Format.</p> 

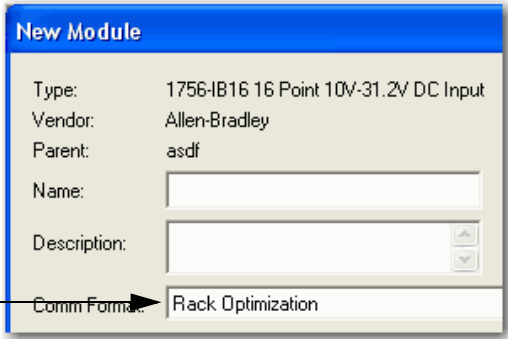
Term	Definition
Rack-optimized connection	<p>For digital I/O modules, you can choose rack-optimized communication. A rack-optimized connection consolidates connection usage between the controller and all the digital I/O modules in the chassis (or DIN rail). Rather than having individual, direct connections for each I/O module, there is one connection for the entire chassis (or DIN rail).</p> <div style="text-align: right; margin-top: 20px;">  </div>

**IMPORTANT**

If you use different 1756 EtherNet/IP communication modules in a remote chassis, such as a 1756-ENBT module and a 1756-EN2T module, do not use a rack-optimized communication format to the remote chassis.

If you must use a rack-optimized communication format with a remote 1756 chassis, install the 1756-ENBT and 1756-EN2T modules in a separate remote chassis.

### Direct Connections For I/O Modules

In this example, assume that each distributed I/O module is configured for a direct connection to the controller.

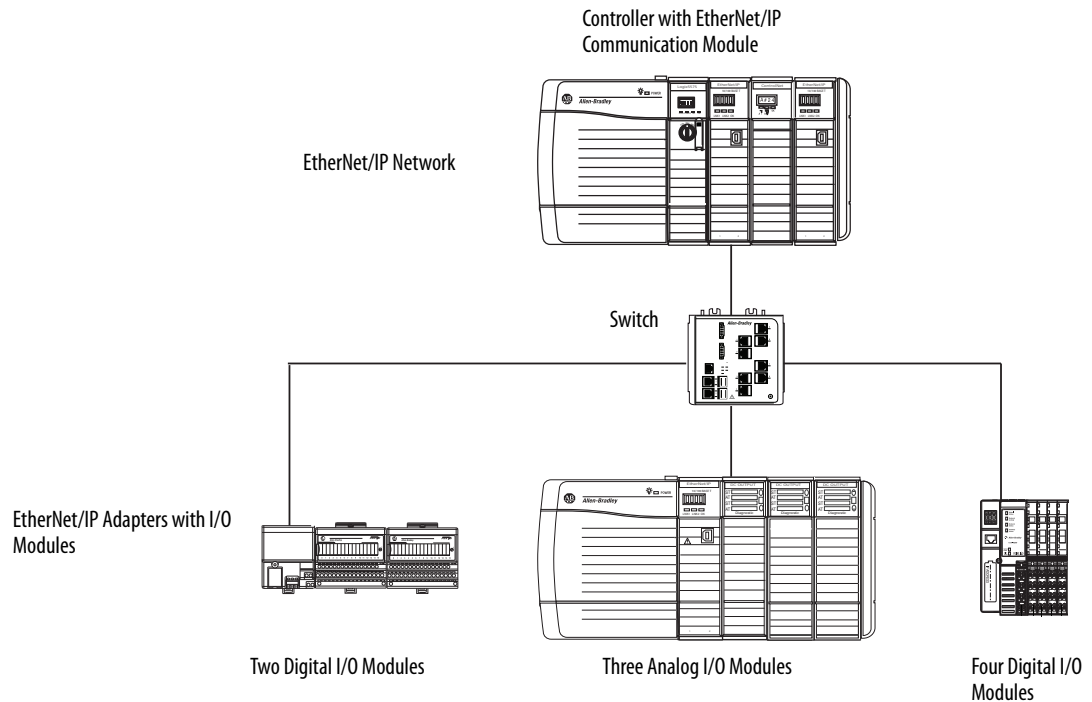

**Table 3 - Example - System Connections**

System Connections	Amount
Controller to local EtherNet/IP communication module	0
Controller to EtherNet/IP adapter	
Direct connection for digital I/O modules	6
Direct connection for analog I/O modules	3
Total connections used	9

If you have many modules, direct connections to each module may not be feasible because you could use up the number of connections and packets per second supported by the module.

See [Rack-optimized Connections for I/O Modules on page 40](#) to conserve connection use and network traffic.

### Rack-optimized Connections for I/O Modules

In this example, assume that each digital I/O module is configured for a rack-optimized connection to the controller. Analog modules must be configured for direct connections.

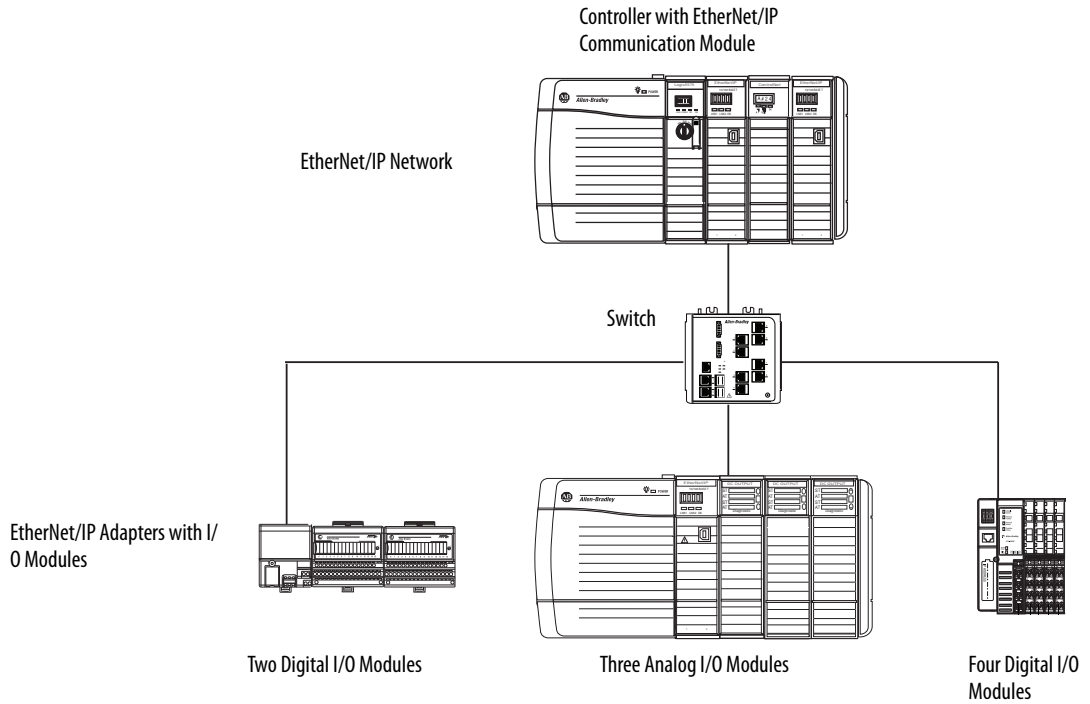

### Example - System Connections

System Connections	Amount
Controller to local EtherNet/IP communication module	0
Controller to EtherNet/IP adapter with digital modules (rack-optimized connection to each adapter)	2
Controller to EtherNet/IP adapter with analog modules (direct connection for each analog I/O module)	3
Total connections used	5

The rack-optimized connection conserves connections, but can limit the status and diagnostic information that is available from the I/O modules.

To optimize the number of available connections, use a rack-optimized connection between any digital I/O that allows it and the remote adapter that connects the distributed I/O to the controller via the communication module.



## Ownership

In a Logix5000 system, modules multicast data. Therefore, multiple modules can receive the same data at the same time from a single module. When choosing a communication format, decide whether to establish an owner-controller or listen-only relationship with the module.

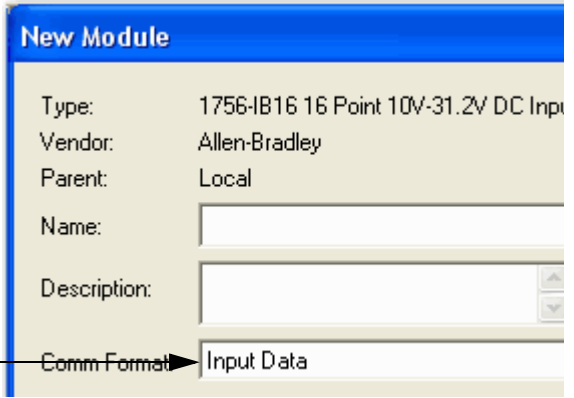
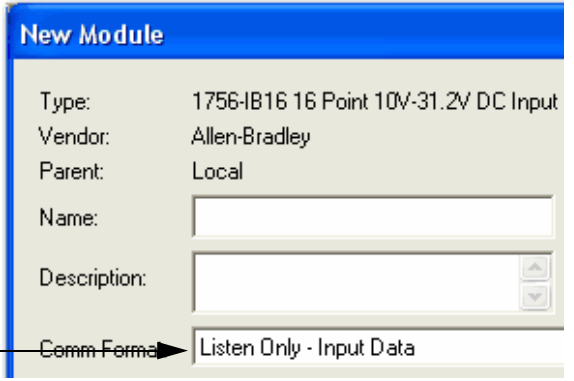
Ownership Type	Description
Owner controller	<p>The controller that creates the primary configuration and communication connection to a module. The owner controller writes configuration data and can establish a connection to the module.</p> <p>An owner connection is any connection that does not include Listen-Only in its Comm Format.</p> 
Listen-only connection	<p>An I/O connection where another controller owns/provides the configuration data for the I/O module. A controller using a listen-only connection monitors only the module. It does not write configuration data and can only maintain a connection to the I/O module when the owner controller is actively controlling the I/O module.</p> <p>Listen-only connection</p> 

**Table 4 - Choosing a Type of Module Ownership**

Module Type	Another Controller	Desired Conditions	Use This Connection Type
Input module	Does not own the module	—————▶	Owner
	Owns the module	Maintain communication with the module if it loses communication with the other controller	Owner Use the same configuration as the other owner controller.
		Stop communication with the module if it loses communication with the other controller	Listen-only
Output module	Does not own the module	—————▶	Owner
	Owns the module	—————▶	Listen-only

**Table 5 - Input and Output Modules - Differences in Ownership**

Control	This Ownership	Description
Input modules	Owner	An input module is configured by a controller that establishes a connection as an owner. This configuring controller is the first controller to establish an owner connection. Once an input module has been configured and owned by a controller, other controllers can establish owner connections to that module. This allows additional owners to continue to receive multicast data if the original owner controller breaks its connection to the module. Additional owners must have the identical configuration data and communication format as the original owner controller; otherwise, the connection attempt is rejected.
	Listen-only	Once an input module has been configured and owned by a controller, other controllers can establish a listen-only connection to that module. These controllers can receive multicast data while another controller owns the module. If all owner controllers break their connections to the input module, all controllers with listen-only connections no longer receive multicast data.
Output modules	Owner	An output module is configured by a controller that establishes a connection as an owner. Only one owner connection is allowed for an output module. If another controller attempts to establish an owner connection, the connection attempt is rejected.
	Listen-only	Once an output module has been configured and owned by one controller, other controllers must establish listen-only connections to that module. These controllers can receive multicast data while another controller owns the module. If the owner controller breaks its connection to the output module, all controllers with listen-only connections no longer receive multicast data.

## Select a Remote Adapter

The type of distributed I/O modules that you need to access determines which adapter to use.

**Table 6 - Choice of Remote Adapter**

Type of Distributed I/O	Available Remote Adapters
1756 ControlLogix I/O	1756-ENBT, 1756-EN2T, 1756-EN2TR, 1756-EN2TXT, 1756-EN2F, or 1756-EN3TR communication module
1794 FLEX I/O	1794-AENT
1734 POINT I/O™	1734-AENT
1769 Compact I/O	1769-AENTR

## Set the Requested Packet Interval (RPI)

When you configure an I/O module, you define the requested packet interval (RPI) for the module. Only data-producing modules require an RPI. For example, a local EtherNet/IP communication module requires no RPI because it produces no data for the system. Instead it functions only as a bridge.

To set an RPI, follow these steps.

1. Make sure the module is installed, started and connected to the controller via a serial, or other network, connection.
2. In the Controller Organizer, right-click the EtherNet/IP communication module and choose Properties.

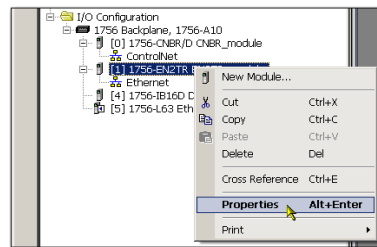

The Module Properties dialog box appears.

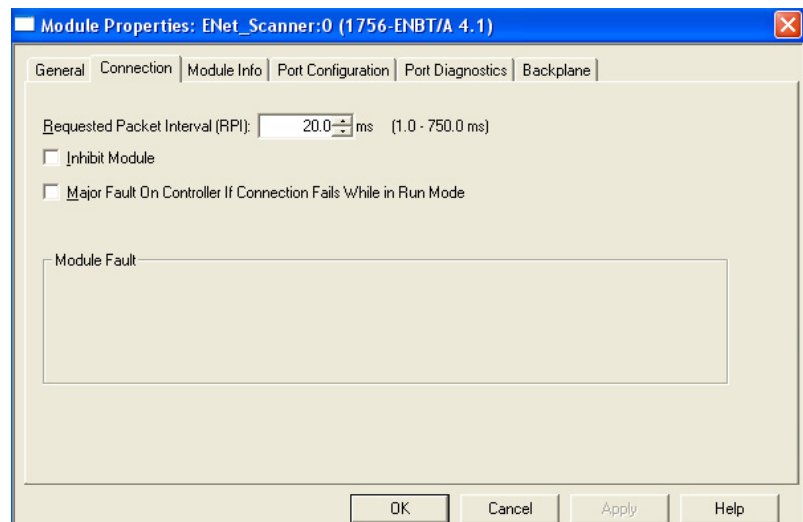

3. Click the Connection tab.

4. From the Requested Packet Interval (RPI) menu, enter the rate at which you want data to be updated over a connection.

Only set the RPI to the rate the application requires.

---

**IMPORTANT** The RPI determines the number of packets per second that the module produces on a connection. Each module can produce only a limited number of packets per second. Exceeding this limit prevents the module from opening more connections.

---

5. Click OK.

Unlike EtherNet/IP communication modules, in Logix5000 controllers, I/O values update at an interval set via the project's I/O configuration folder. The values update asynchronously to the execution of logic. At the specified interval, the controller updates a value independently from the execution of logic.

## Access Distributed I/O

I/O information is presented as a structure of multiple fields, which depends on the specific features of the I/O module. The name of the structure is based on the location of the I/O module in the system. Each I/O tag is automatically created when you configure the I/O module through the programming software.

Each tag name follows this format:

Location:SlotNumber:Type.MemberName.SubMemberName.Bit

This address variable	Is
Location	Identifies network location LOCAL = local DIN rail or chassis ADAPTER_NAME = identifies remote adapter or bridge
SlotNumber	Slot number of I/O module in its chassis
Type	Type of data I = input O = output C = configuration S = status
MemberName	Specific data from the I/O module, which depends on the type of data the module can store For example, Data and Fault are possible fields of data for an I/O module. Data is the common name for values the are sent to or received from I/O points.
SubMemberName	Specific data related to a MemberName
Bit (optional)	Specific point on the I/O module, which depends on the size of the I/O module (0...31 for a 32-point module)

## EXAMPLE

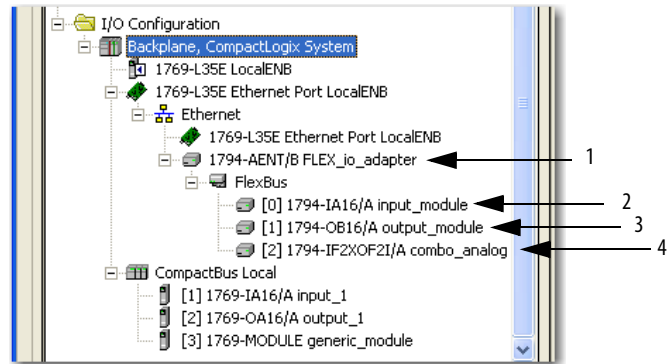

Example	Module	Example Tag Names (automatically created by the software)
1	Remote 1794-AENT adapter "FLEX_io_adapter"	FLEX_io_adapter:I FLEX_io_adapter:I.SlotStatusBits FLEX_io_adapter:I.Data FLEX_io_adapter:O FLEX_io_adapter:O.Data
2	Remote 1794-IA16 "input_module" in slot 0 Rack-optimized connection	FLEX_io_adapter:0:C FLEX_io_adapter:0:C.Config FLEX_io_adapter:0:C.DelayTime_0 FLEX_io_adapter:0:C.DelayTime_1 FLEX_io_adapter:0:C.DelayTime_2 FLEX_io_adapter:0:C.DelayTime_3 FLEX_io_adapter:0:C.DelayTime_4 FLEX_io_adapter:0:C.DelayTime_5 FLEX_io_adapter:0:I
3	Remote 1794-OB16 "output_module" in slot 1 Rack-optimized connection	FLEX_io_adapter:1:C FLEX_io_adapter:1:C.SSDData FLEX_io_adapter:1:O FLEX_io_adapter:1:O.Data
4	Remote 1794-IF2XOF2I "combo_analog" in slot 2 Direct connection	FLEX_io_adapter:2:C FLEX_io_adapter:2:C.InputFilter FLEX_io_adapter:2:C.InputConfiguration FLEX_io_adapter:2:C.OutputConfiguration FLEX_io_adapter:2:C.RTSInterval FLEX_io_adapter:2:C.SSch00uputData FLEX_io_adapter:2:C.SSch10OutputData FLEX_io_adapter:2:I

Using rack optimization for an I/O module creates tags as aliases for the adapter module's tags. This logic displays the device's tag as an alias for the adapter module's tag. In this example, the tag name of the adapter is in angle brackets.

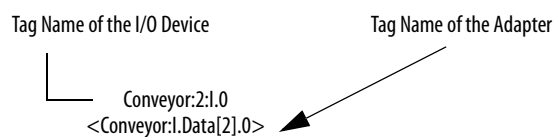

**Notes:**

## Interlocking and Data Transfer between Controllers

This chapter describes how to share data by interlocking controllers (producing and consuming tags) and transferring messages between controllers via an EtherNet/IP network.

Topic	Page
Set Up the Hardware	48
Tag Guidelines for Produced or Consumed Data	49
Connections for Produced and Consumed Tags	50
Produce a Tag	51
Consume Data Produced by Another Controller	53
Guidelines for Message (MSG) Instructions	58
Connections for Messages	59
ENTER Message Logic	60
Configure a MSG Instruction	63
Communicate with PLC-5 or SLC Controllers	67

**Table 7 - Communication Methods**

If you want to	And the data	Then	Page
Interlock operations	Resides on Logix5000 controllers	Produce and consume a tag	49
Transfer data	Needs regular delivery at an interval that you specify	Produce and consume a tag	49
	Is sent when a specific condition occurs in your application	Execute a message (MSG) instruction	58

## Set Up the Hardware

In this example, the controller in the local chassis produces a tag that the Logix5000 controller in the remote chassis consumes. The local controller can also send a MSG instruction to the remote controller.

**Figure 4 - Sharing Data and Transferring Messages**

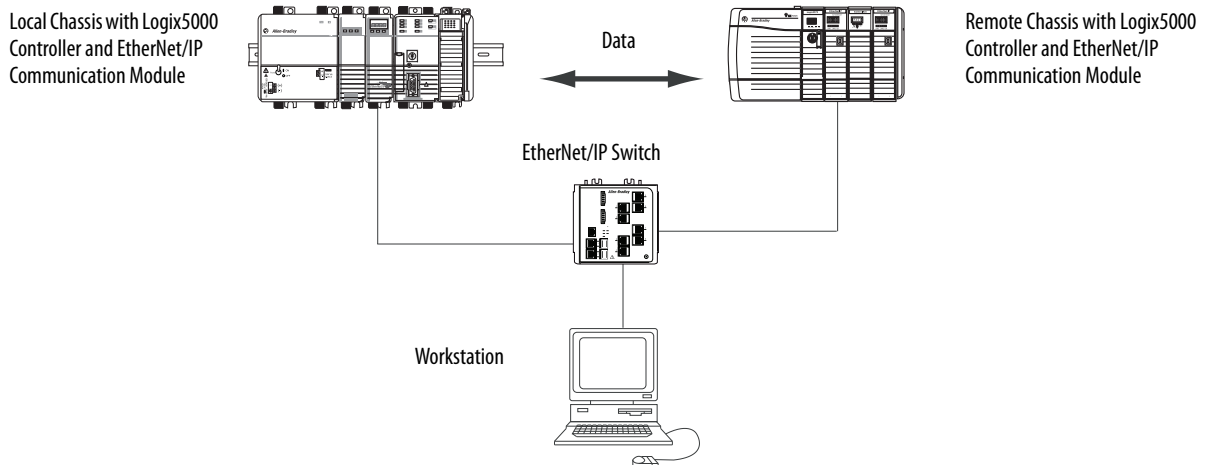

You must complete these tasks before Logix5000 controllers can share tags over an EtherNet/IP network:

- Set the IP addresses and other network parameters for each EtherNet/IP communication module.
- Connect all wiring and cabling.
- Configure a communication driver (such as AB-ETHIP-1) for the programming workstation.

---

**IMPORTANT** If you are sharing tags between ControlLogix controllers and the controllers are sharing only tags, not sending messages, set the communication format of the 1756-ENBT, 1756-EN2F, 1756-EN2T, 1756-EN2TR, 1756-EN2TXT, 1756-EN3TR, 1756-EN2TSC and 1756-EN2TRTXT module to None.

---



## Tag Guidelines for Produced or Consumed Data

To properly organize tags for produced or consumed data (shared data), follow these guidelines.

**Table 8 - Guidelines for the Organization of Tags**

Guideline	Details
Create the tags at the controller scope.	You can share only controller-scoped tags.
Use one of these data types: <ul style="list-style-type: none"> <li>• DINT</li> <li>• REAL</li> <li>• array of DINTs or REALs</li> <li>• user-defined</li> </ul>	<ul style="list-style-type: none"> <li>• To share other data types, create a user-defined data type that contains the required data.</li> <li>• Use the same data type for the produced tag and corresponding consumed tag or tags.</li> </ul>
Limit the size of the tag to $\leq 500$ bytes.	If transferring more than 500 bytes, create logic to transfer the data in packets. A size of $< 125$ DINT words will keep total bytes within 500. This helps reduce the total number of packets for transactions.
Combine data that goes to the same controller.	<p>If producing several tags for the same controller:</p> <ul style="list-style-type: none"> <li>• Group the data into one or more user-defined data types. This method uses fewer connections than does producing each tag separately.</li> <li>• Group the data according to similar update intervals. To conserve network bandwidth, use a greater RPI for less critical data.</li> </ul> <p>For example, you could create one tag for data that is critical and another tag for data that is not as critical.</p>

## Terminology

A Logix5000 controller can produce (broadcast) and consume (receive) system-shared tags.

**Table 9 - Tag Definitions**

Term	Definition
Produced tag	A tag that a controller makes available for use by other controllers. Multiple controllers can simultaneously consume (receive) the data. A produced tag sends its data to one or more consumed tags (consumers) without using logic. The produced tag sends its data at the RPI of the consuming tag.
Consumed tag	A tag that receives the data of a produced tag. The data type of the consumed tag must match the data type (including any array dimensions) of the produced tag. The RPI of the consumed tag determines the period at which the data updates.

To share produced or consumed tags, two controllers must be attached to the same EtherNet/IP subnet. Two controllers cannot bridge produced or consumed tags over two subnets.

## Connections for Produced and Consumed Tags

Logix controllers can produce (broadcast) and consume (receive) system-shared tags that are sent and received via the EtherNet/IP communication module. Produced and consumed tags each require connections.

**Table 10 - Required Connections for Produced and Consumed Tags**

Tag Type	Required Connections
Produced	The local controller (producing) must have one connection for the produced tag and the first consumer and one more connection for each additional consumer (heartbeat). The produced tag requires two connections.  As you increase the number of controllers that can consume a produced tag, you also reduce the number of connections the controller has available for other operations, such as communication and I/O.
Consumed	Each consumed tag requires one connection for the controller that is consuming the tag.  <b>IMPORTANT:</b> When you configure a consumed tag, you must add a remote module to the producing controller's Studio 5000 environment project to configure the consuming controller. The default Comm Format when adding a remote module to the project is Rack Optimized.  Change the Comm Format to None when adding the remote communication module.

All EtherNet/IP communication modules support as many as 32 produced multicast connections. Because each tag that passes through an EtherNet/IP communication module uses a single connection, the number of available connections limits the total number of tags that can be produced or consumed. If the communication module uses all of its connections for I/O and other communication modules, no connections remain for produced and consumed tags.

---

**IMPORTANT** Depending on whether it is producing or consuming a tag, a Logix5000 controller uses its connections differently.

---

**Table 11 - Number Connections for Produced and Consumed Tags**

Type of Tag	Device	Number of Connections Used
Produced tag	Logix5000 controller	Number_of_consumers + 1
	EtherNet/IP communication module	1
Consumed tag	Logix5000 controller EtherNet/IP communication module	1

This graphic shows a Logix5000 controller producing a single tag for consumption by another Logix5000 controller. In this example, the producing controller uses 2 connections and every other Logix module/controller uses only 1 connection.

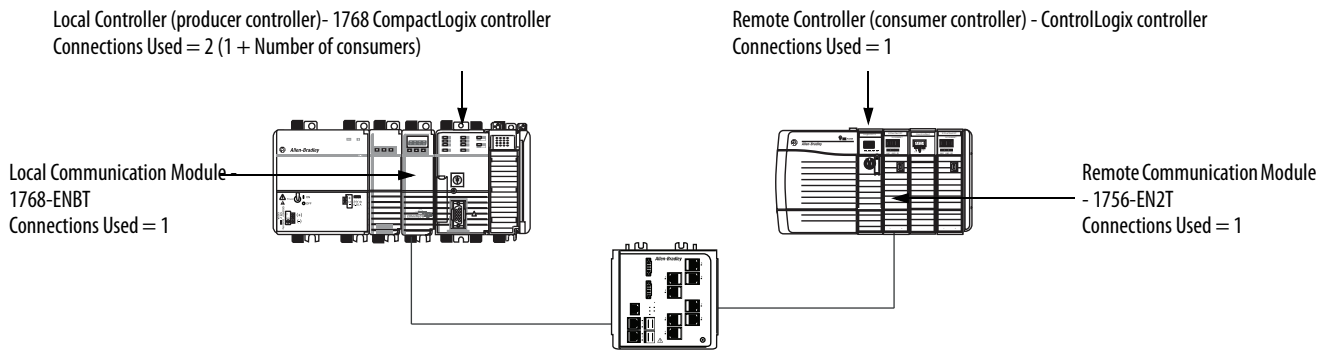
**Figure 5 - Logix5000 Controller in Local Chassis Producing a Single Tag for a Logix5000 Controller in a Remote Chassis**

At its limits, a Logix5000 controller that produced 125 tags, each with only 1 consumer, the controller would use all of its available 250 connections. In this example, the EtherNet modules used to communicate the tags would use only 125 connections. An example of the different.

For more information on using connections over an EtherNet/IP network, see Ethernet Design Considerations Reference Manual, publication [ENET-RM002](#).

## Produce a Tag

To produce a tag, configure the produced tag in the Studio 5000 Logix Designer project for the local (producer) controller. You do not have to configure the consumer controllers in the I/O Configuration folder of the producer controller.

## Configure the Produced Tag

To configure the produced tag, follow these steps.

1. In the producer's Controller Organizer, right-click the Controller Tags folder and choose Edit Tags.

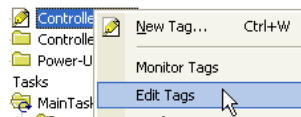

The Controller Tags dialog box appears.

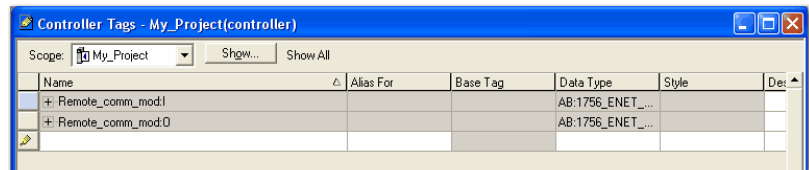

You can produce only controller-scoped tags.

- In the Controller Tags window, right-click the tag that you want to produce and choose Edit Tag Properties.

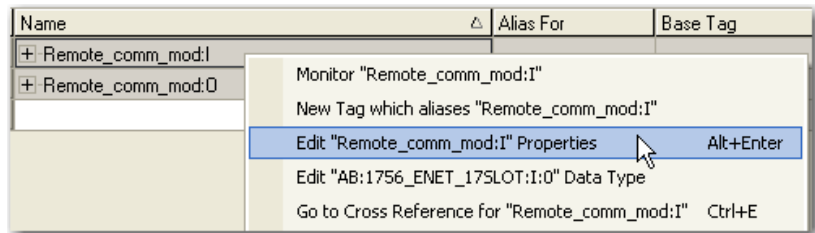

The Tag Properties dialog box appears.

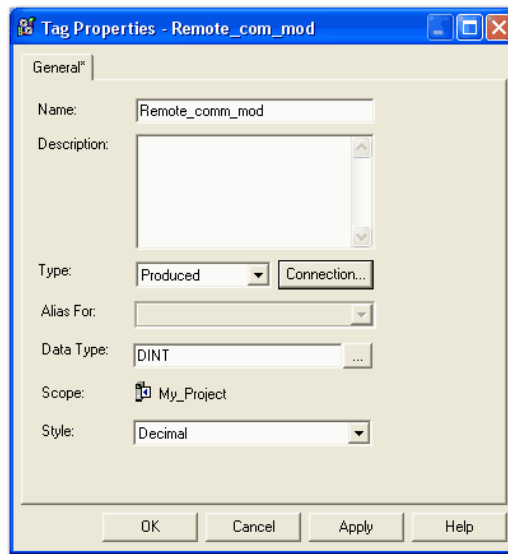

- From the Type pull-down menu, choose Produced.
- Click Connection.

The Produced Tag Connection dialog box appears.

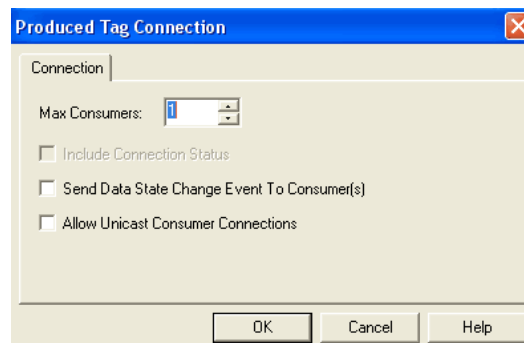

- In the Max Consumers field, type the maximum number of controllers that will consume (receive) the tag.
- Click OK.

## Consume Data Produced by Another Controller

To consume a produced tag, specify both the producer controller and the produced tag in the Studio 5000 Logix Designer project for the remote (consumer) Logix5000 controller.

### Add the Producer Controller to the Consumer's I/O Configuration

Add the producer controller to the remote controller's I/O Configuration folder. In the folder, organize the controllers and communication modules into a hierarchy of tree/branch and parent/child.

**Figure 6 - Logix5000 Controller in Local Chassis Consuming a Single Tag for a Logix5000 Controller in a Remote Chassis**

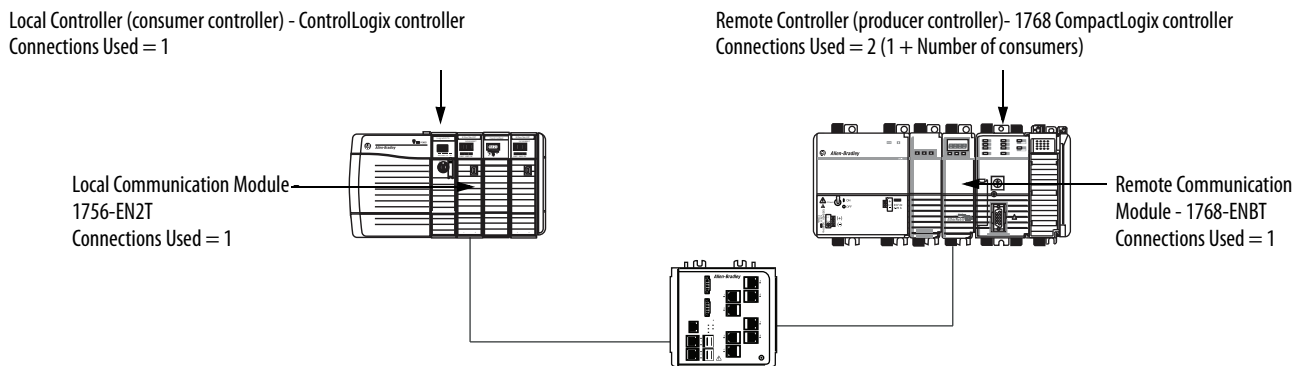

To add a producer controller to the consumer controller's I/O, follow these steps.

1. Add the local communication module for the consumer controller.
2. Add the remote communication module for the producer controller.
3. Add the producer controller.

This graphic shows the consumer controller's I/O configuration after the modules are added.

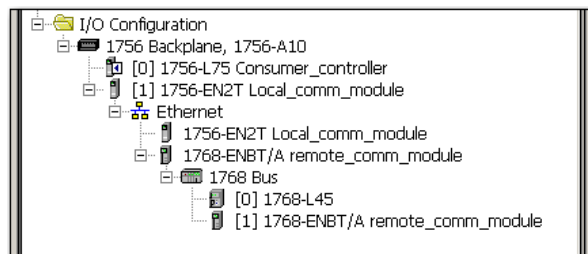

To add a producer controller to the I/O Configuration folder, follow these steps.

1. In the Controller Organizer, right-click the remote backplane and choose New Module.

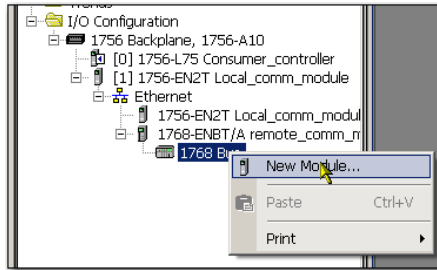

The Select Module Type dialog box appears.

2. Click the By Category tab and choose your producer controller.

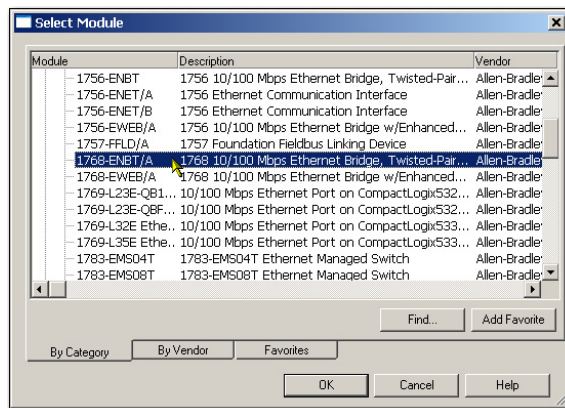

3. Click OK.

Depending on the controller type, the Select Major Revision dialog box may appear. If the dialog box appears, choose the module's major revision and click OK.

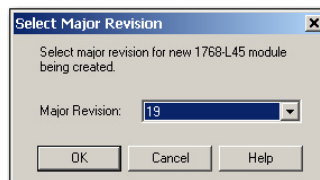

The New Module dialog box appears.

4. Configure your new module.
  - In the Name field, type the name of your module.
  - In the Slot field, type the chassis slot number.
  - From the Electronic Keying pull-down menu, choose the keying level that fits your application.

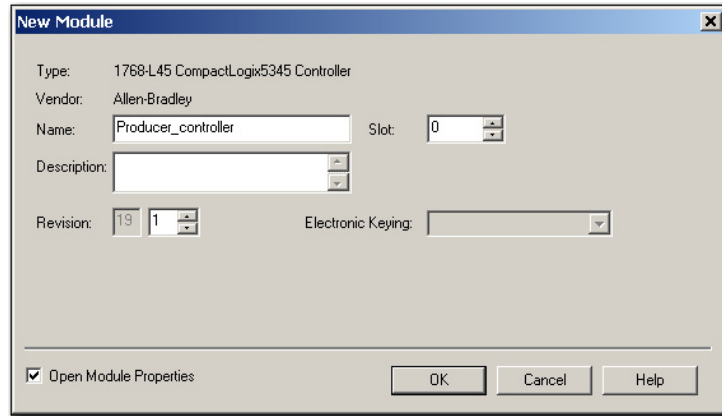

5. Click OK.

---

**IMPORTANT** The number and type of configuration parameters on the New Module dialog box varies according to the controller type.

---

## Create the Consumed Tag

To create the consumed tag, follow these steps.

1. In the consumer controller's project in the Studio 5000 environment, right-click the Controller Tags folder and choose Edit Tags.

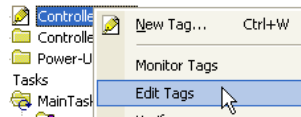

The Controller's Tag dialog box appears.

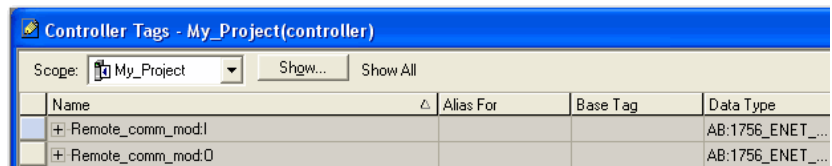

Only controller-scoped tags can consume data.

- In the Controller Tags window, right-click the tag that will consume the data and choose Edit Tag Properties.

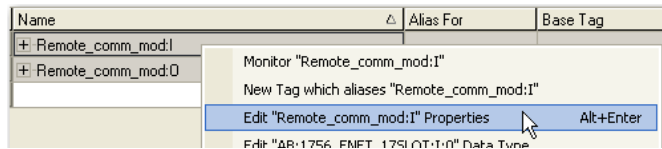

The Tag Properties dialog box appears.

- From the Type pull-down menu, choose Consumed.
- In the Data Type field, type a data type that matches the type assigned to the produced tag.
- Click Connection.

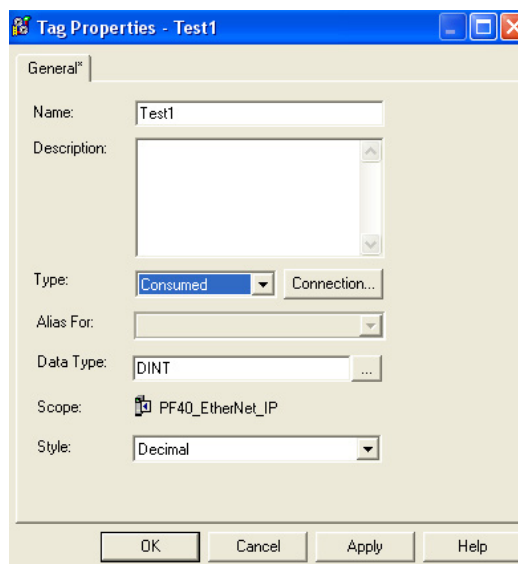

The Consumed Tag Connection dialog box appears.

- From the Producer pull-down menu, choose the controller that produces the data.



7. In the Remote Data field, type the tag name or instance number of the produced data.
8. In the RPI field, type the requested packet interval (RPI) for the connection.

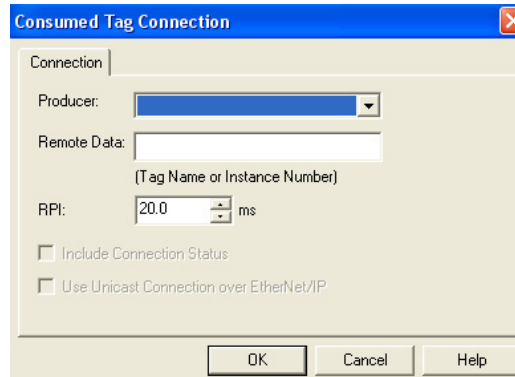

Only set the RPI to the rate the application requires.

---

**IMPORTANT** The RPI determines the number of packets per second that the module will produce on a connection. Each module can only produce a limited number of packets per second. Exceeding this limit prevents the module from opening more connections.

---

For information on RPI and how it affects the actual packet interval (API), see the Ethernet Design Considerations Reference Manual, publication [ENET-RM001](#).

9. Click OK.

## Guidelines for Message (MSG) Instructions

Follow these guidelines.

**Table 12 - MSG Instruction Guidelines**

Guideline	Description
For each MSG instruction, create a control tag.	Each MSG instruction requires its own control tag: <ul style="list-style-type: none"> <li>• Data type = MESSAGE</li> <li>• Scope = controller</li> <li>• The tag cannot be part of an array or a user-defined data type.</li> </ul>
Keep the source and destination data at the controller scope.	A MSG instruction can only access tags that are in the Controller Tags folder.
If your MSG is to a module that uses 16-bit integers, use a buffer of INTs in the MSG and DINTs throughout the project.	If your message is to a module that uses 16-bit integers, such as a PLC-5® or SLC™ 500 controller, and it transfers integers (not REALs), use a buffer of INTs in the message and DINTs throughout the project.  This increases the efficiency of your project because Logix5000 controllers execute more efficiently and use less memory when working with 32-bit integers (DINTs).
Cache the connected MSGs that execute most frequently.	Cache the connection for those MSG instructions that execute most frequently, up to the maximum number permissible for your controller revision.  This optimizes execution time because the controller does not have to open a connection each time the message executes.
If you want to enable more than 16 MSGs at one time, use some type of management strategy.	If you enable more than 16 MSGs at one time, some MSG instructions may experience delays in entering the queue. To guarantee the execution of each message, perform one of these tasks: <ul style="list-style-type: none"> <li>• Enable each message in sequence.</li> <li>• Enable the messages in groups.</li> <li>• Program a message to communicate with multiple modules.</li> <li>• Program logic to coordinate the execution of messages.</li> </ul>
Keep the number of unconnected and uncached MSGs less than the number of unconnected buffers.	The controller can have 10...40 unconnected buffers. The default number is 10. <ul style="list-style-type: none"> <li>• If all the unconnected buffers are in use when an instruction leaves the message queue, the instruction errors and does not transfer the data.</li> <li>• You can increase the number of unconnected buffers to a maximum of 40.</li> </ul>

For more information on programming MSG instructions, see the Logix5000 Controller General Instructions Reference Manual, publication [1756-RM003](#).

The individual system user manuals for Logix5000 controllers also provide MSG examples unique to specific controller platforms.

## Connections for Messages

Messages transfer data to other modules, such as other controllers or operator interfaces. Each message uses one connection, regardless of how many modules are in the message path. To conserve connections, you can configure one message to read from or write to multiple modules.

These connected messages can leave the connection open (cache) or close the connection when the message is done transmitting.

**Table 13 - Message Connections**

Type of Message	Communication Method Used	Connection Used
CIP data table read or write	CIP	Yes
PLC-2, PLC-3, PLC-5, or SLC (all types)	CIP	No
	CIP with Source ID	No
	DH+	Yes
CIP generic	CIP	Your choice <sup>(1)</sup>
Block-transfer read or write		Yes

(1) You can connect CIP generic messages, but for most applications we recommend you leave CIP generic messages unconnected.

## Cache Message Connections

Use the message's execution rate to determine whether to cache a connection or not.

**Table 14 - Guidelines for Caching Message Connections**

Message Execution	Instruction Configuration
Repeated	Cache the connection.  <b>Important:</b> Caching keeps the connection open and optimizes execution time. Opening a connection each time the message executes increases execution time.
Infrequent	Do not cache the connection.  <b>Important:</b> Not caching closes the connection upon completion of the message, freeing up the connection for other uses.

## Communicate with the Socket Object via a MSG Instruction

Some EtherNet/IP devices support the use of a CIP Generic MSG instruction to request socket services. For more information, see EtherNet/IP Socket Interface Application Technique, [ENET-AT002](#).

## ENTER Message Logic

To send or receive data from an EtherNet/IP communication module via a message, you must program a MSG instruction in the local controller's logic. If the target module is configured in the I/O Configuration folder of the controller, browse to select the module or manually type the message path in the MSG instruction.

### Add the EtherNet/IP Communication Module to the Local Controller's I/O Configuration

To use the Browse button to select the target device of a MSG instruction, add that remote device to the I/O Configuration folder of the local controller. Within the I/O Configuration folder, organize the local and remote devices into a hierarchy of tree/branch, parent/child.

**Figure 7 - Logix5000 Controller in Local Chassis Sending a Message to a Logix5000 Controller in a Remote Chassis**

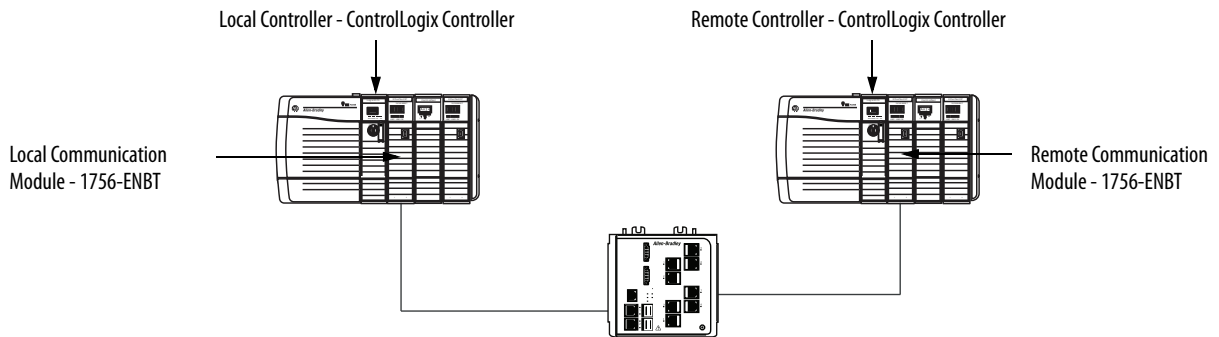

For a typical local/remote MSG structure, following the steps.

1. Add the local communication module for the local controller.
2. Add the remote communication module for the remote controller.
3. Add the remote controller.

This graphic shows the local controller's I/O configuration after a local EtherNet/IP communication module is added.

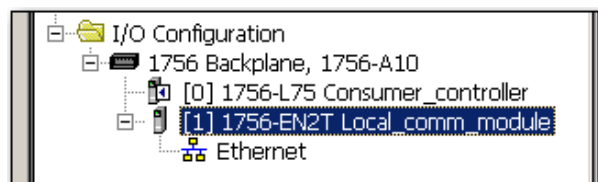

Select a communication format for a communication module based on the modules in its remote chassis.

**Table 15 - Module Communication Formats**

Conditions	Use This Communication Format
The remote chassis contains only analog modules, diagnostic digital modules, fused output modules, or communication modules	None
The remote chassis contains only standard, digital input and output modules (no diagnostic modules or fused output modules)	Rack Optimization
You want to receive I/O module and chassis slot information from a rack-optimized remote chassis owned by another controller	Listen-Only Rack Optimization

To add a module to the I/O Configuration folder, follow these steps.

1. In the Studio 5000 environment, right-click the level to which you want to add the new module and choose New Module.

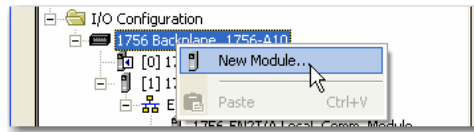

The Select Module Type dialog box appears.

2. Click the By Category tab and choose your EtherNet/IP communication module.
3. Click OK.

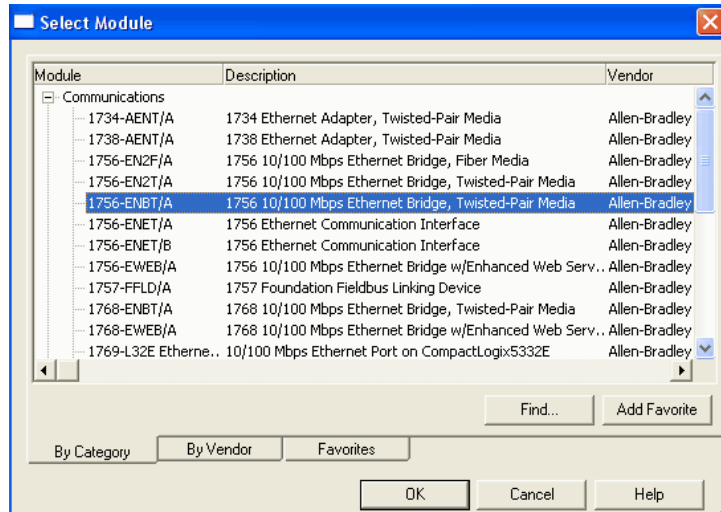

Depending on the EtherNet/IP communication module, the Select Major Revision dialog box may appear. If the dialog box appears, choose the module's major revision and click OK.

The New Module dialog box appears.

4. Configure your new module.
  - In the Name field, type the name of your module.
  - In the IP Address field, type the module IP address.
  - In the Slot field, type the chassis slot number.
  - Click Change to configure these parameters:
    - Module Revision
    - Electronic Keying
    - Communication Format
5. Click OK.

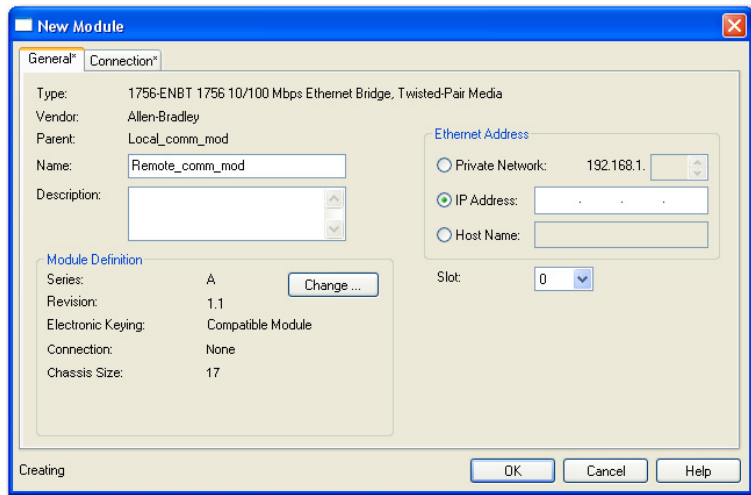

**IMPORTANT** The number and type of configuration parameters on the New Module dialog box varies according to the EtherNet/IP communication module type.

## Enter a Message

To enter a message, follow these steps.

1. Use relay ladder logic to enter a MSG instruction.
2. Click  to configure the MSG instruction.

### EXAMPLE Enter a MSG instruction

If  $count\_send = 1$  and  $count\_msg.EN = 0$  (MSG instruction is not already enabled), then execute a MSG instruction that sends data to another controller.



**Configure a MSG Instruction**

To configure a MSG instruction, follow these steps.

1. Click  in the MSG box.

The Message Configuration dialog box appears.

2. Click the Configuration tab and specify the type of MSG instruction.

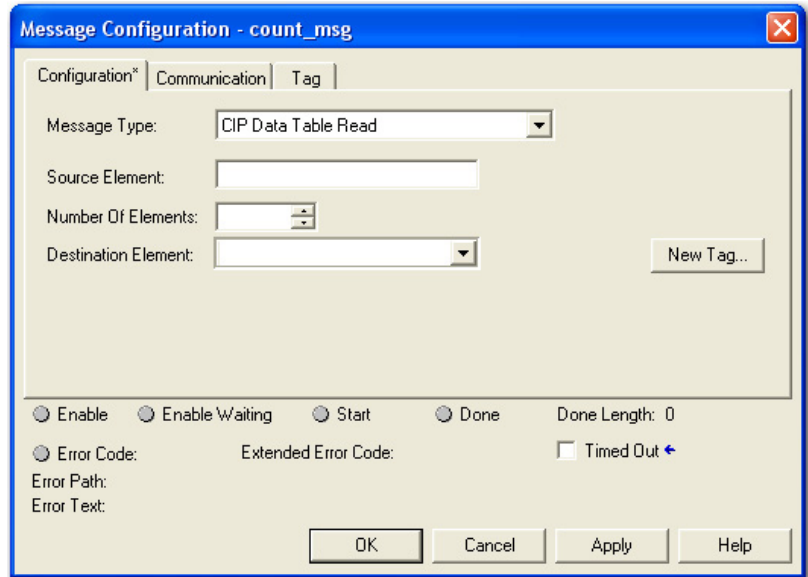
*Configure a MSG to a Logix5000 Controller*

If you want to	For this item	Type or choose
Read (receive) the data	Message Type	CIP Data Table Read
	Source Element	First element of the tag that contains data in the other controller
	Number of Elements	Number of elements to transfer
	Destination Tag	First element of the tag (controller-scoped) in this controller for the data
Write (send) the data	Message Type	CIP Data Table Write
	Source Tag	First element of the tag (controller-scoped) in this controller that contains the data
	Number of Elements	Number of elements to transfer
	Destination Element	First element of the tag for the data in the other controller

*Configure a MSG to an SLC 500 Controller*

If the data is	And you want to	For this item	Type or choose
Integer	Read (receive) data	Message Type	SLC Typed Read
		Source Element	Data table address in the SLC 500 controller (for example, N7:10)
		Number of Elements	Number of integers to transfer
		Destination Tag	First element of int_buffer
	Write (send) data	Message Type	SLC Typed Write
		Source Tag	First Element of int_buffer
		Number of Elements	Number of integers to transfer
		Destination Element	Data table address in the SLC 500 controller (for example, N7:10)
Floating-point (REAL)	Read (receive) data	Message Type	SLC Typed Read
		Source Element	Data table address in the SLC 500 controller (for example, F8:0)
		Number of Elements	Number of values to transfer
		Destination Tag	First element of the tag (controller-scoped) in this controller for the data
	Write (send) data	Message Type	SLC Typed Write
		Source Tag	First element of the tag (controller-scoped) in this controller that contains the data
		Number of Elements	Number of values to transfer
		Destination Element	Data table address in the SLC 500 controller (for example, F8:0)

*Configure a MSG to a PLC-5 Controller*

If the data is	And you want to	For this item	Type or choose
Integer	Read (receive) data	Message Type	PLC5 Typed Read
		Source Element	Data table address in the PLC-5 controller (for example, N7:10)
		Number of Elements	Number of integers to transfer
		Destination Tag	First element of int_buffer
	Write (send) data	Message Type	PLC5 Typed Write
		Source Tag	First element of int_buffer
		Number of Elements	Number of integers to transfer
		Destination Element	Data Table address in the PLC-5 controller (for example, N7:10)
Floating-point (REAL)	Read (receive) data	Message Type	PLC5 Typed Read
		Source Element	Data table address in the PLC-5 controller (for example, F8:0)
		Number of Elements	Number of values to transfer
		Destination Tag	First element of the tag (controller-scoped) in this controller for the data
	Write (send) data	Message Type	PLC5 Typed Write
		Source Tag	First element of the tag (controller-scoped) in this controller that contains the data
		Number of Elements	Number of values to transfer
		Destination Element	Data table address in the PLC-5 controller (for example, F8:0)

3. Click the Communication tab.
4. In the Path field, type the communication path.



For a message to a ControlLogix controller, this Studio 5000 environment Message Configuration dialog box appears.

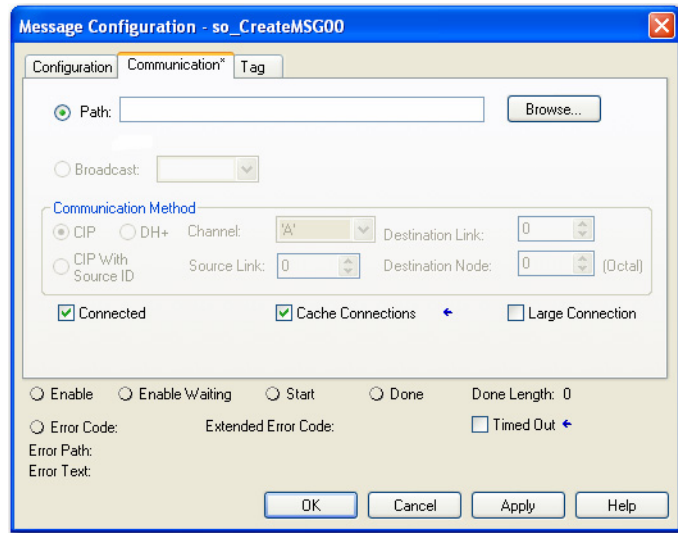

Select the Large Connection checkbox to use a large 4000 byte connection size, or clear the checkbox to use a standard 500 byte connection size.

A large connection is only available with connected MSG instructions. For information about using the Connected or Cache Connections options, refer to the Logix5000 Controllers Messages Programming Manual, publication [1756-PM012](#).

For a message to a SLC 500 or PLC-5 processor, this RSLogix Message Configuration dialog box appears.

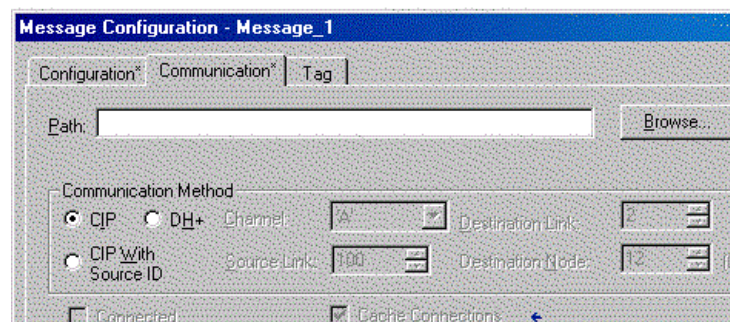

- If the target module is configured in the I/O Configuration folder of the originating controller, click Browse to select the module or manually type the path to the target module.

A manually typed path begins with the name of the local EtherNet/IP communication module, the port the message exits (2 for EtherNet/IP), and the IP address of the next module in the path, which could be the target module.

**EXAMPLE** Communication path from a Logix5000 controller to a Logix5000 controller over an EtherNet/IP network

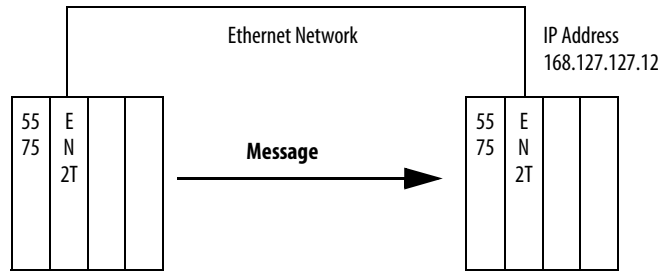

washer, 2, 168.127.127.12, 1, 0

Where	Indicates
Washer	Name of the 1756-ENBT, 1756-EN2F, 1756-EN2T, 1756-EN2TR, 1756-EN2TXT, or 1756-EN3TR module
2	Ethernet port of the 1756-ENBT, 1756-EN2F, 1756-EN2T, 1756-EN2TR, 1756-EN2TXT, or 1756-EN3TR module
168.127.127.12	IP address of the 1756-ENBT, 1756-EN2F, 1756-EN2T, 1756-EN2TR, 1756-EN2TXT, or 1756-EN3TR Module in the destination chassis
1	Backplane port of the 1756-ENBT, 1756-EN2F, 1756-EN2T, 1756-EN2TR, 1756-EN2TXT, or 1756-EN3TR Module in the destination chassis
0	Slot number of the destination controller

## Communicate with PLC-5 or SLC Controllers

If the message is to a PLC-5 or SLC 500 processor and it reads or writes integers (not REALs), use a buffer of INTs in the message. Remember these considerations:

- Logix5000 controllers execute more efficiently and use less memory when working with 32-bit integers (DINTs).
- PLC-5 and SLC 500 processors require 16-bit integers.
- Messages require an INT buffer.
- Data can be moved into or out of the buffer as needed.

### Converting between INTs and DINTs

If the message is to a device that uses 16-bit integers, such as a PLC-5 or SLC 500 controller, and it transfers integers (not REALs), use a buffer of INTs in the message and DINTs throughout the project. This increases the efficiency of your project.

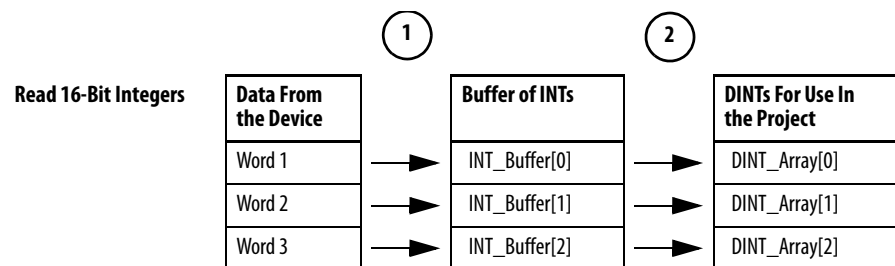

1. The Message (MSG) instruction reads 16-bit integers (INTs) from the device and stores them in a temporary array of INTs.
2. An File Arith/Logical (FAL) instruction converts the INTs to DINTs for use by other instructions in your project.

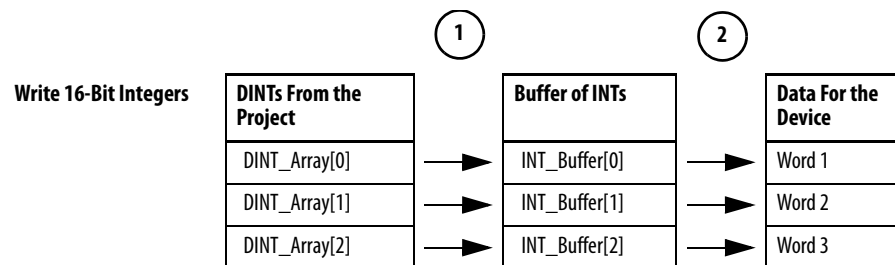

1. An FAL instruction converts the DINTs from the Logix5000 controller to INTs.
2. The MSG instruction writes the INTs from the temporary array to the device.

## Mapping Tags

A Logix5000 controller stores tag names on the controller so that other devices can read or write data without having to know physical memory locations. Many products only understand PLC/SLC data tables, so the Logix5000 controller offers a PLC/SLC mapping function that enables you to map Logix tag names to memory locations.

- You have to map only the file numbers that are used in messages; the other file numbers do not need to be mapped.
- The mapping table is loaded into the controller and is used whenever a logical address accesses data.
- You can access only controller-scoped tags (global data).

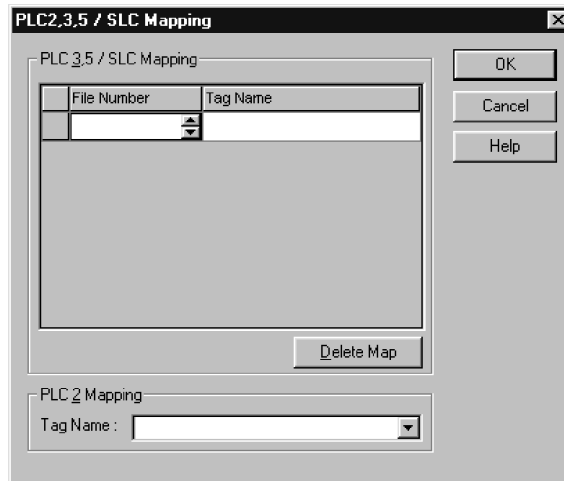

- For each file that is referenced in a PLC-5 or SLC command, make a map entry with one of these methods:
  - Typing the PLC/SLC file number of the logical address
  - Typing or selecting the Logix5000 controller-scoped (global) tag that supplies or receives data for the file number (You can map multiple files to the same tag.)
- For PLC-2 commands, specify the tag that supplies or receives the data.

When mapping tags, remember these guidelines:

- Do not use file numbers 0, 1, and 2. These files are reserved for Output, Input, and Status files in a PLC-5 processor.
- Use PLC-5 mapping only for tag arrays of data type INT, DINT, or REAL. Attempting to map elements of system structures may produce undesirable effects.
- Use the PLC file identifier of N or B when accessing elements in an INT tag array.

This example shows how to use a buffer of INTs.

**EXAMPLE** Read integers from a PLC-5 controller.

**ATTENTION:** When condition turns on, reads 16-bit integer values (INTs) and stores them in int\_buffer. Then the FAL instruction moves the values to dint\_array. This converts the values to 32-bit integers (DINTs), for use by other instructions in the ControlLogix controller.

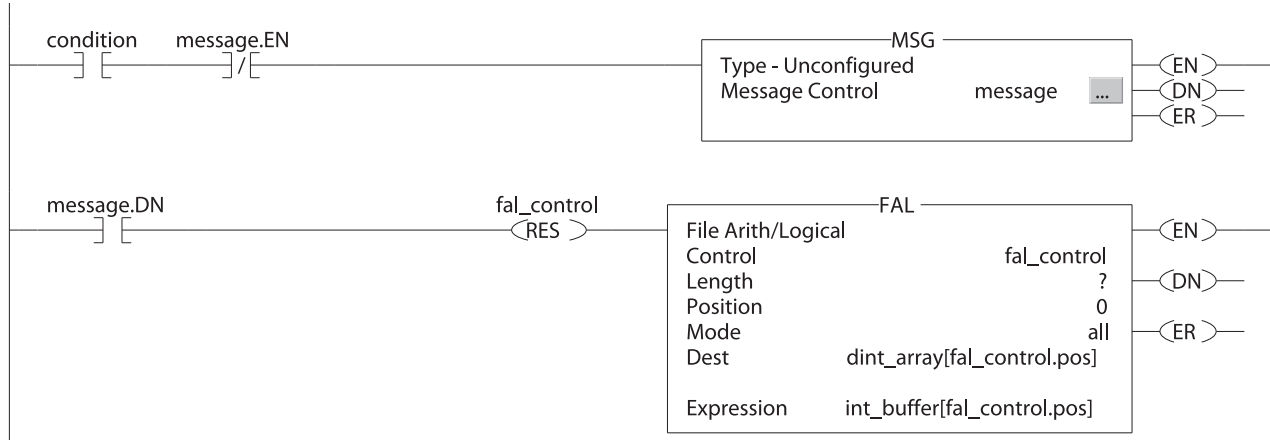

**EXAMPLE** Write integers to a PLC-5 controller.

**ATTENTION:** When condition turns on, moves the values in dint\_array to int\_buffer. This converts the values to 16-bit integers (INTs). Then the message instruction sends int\_buffer to the other controller.

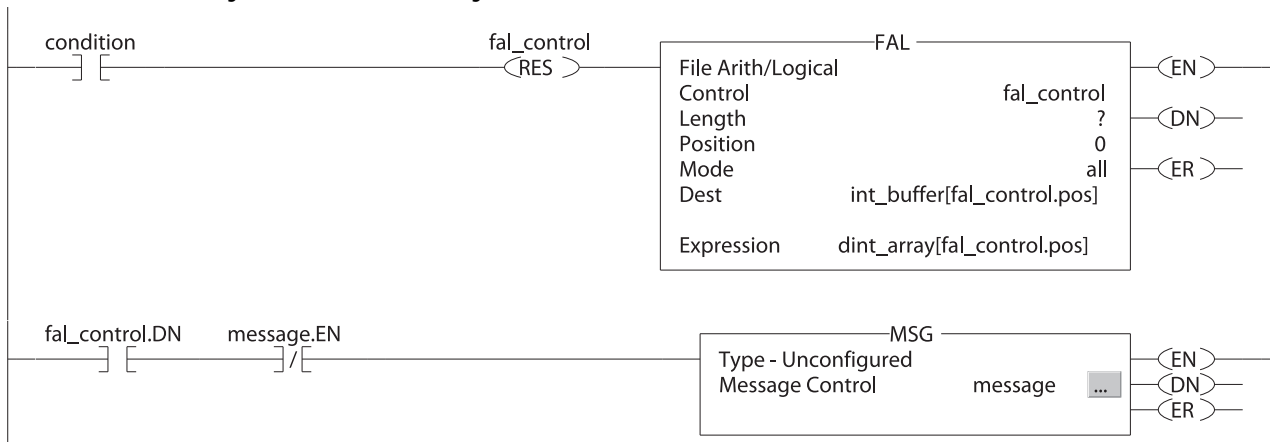

42424

Where	Is an
dint_array	Array of DINTs that are used in the ControlLogix controller
int_buffer	Array of INTs with the same number of elements as dint_array

## Receive MSGs from PLC-5 or SLC 500 Controllers

To receive MSGs from PLC-5 or SLC 500 processors, follow these steps.

1. If the originating controller is a PLC-5 or SLC 500 processor, in the MSG instruction, select PLC5.

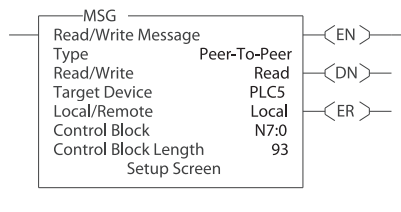

If the controller is a	For this section	And this item	Specify
PLC-5	This PLC-5	Communication Command	PLC-5 Typed Read or PLC-5 Typed Write
		Data Table Address	Starting address of the data in the PLC-5 controller
		Size in Elements	Number of elements to read or write
		Port Number	2
	Target Device	Data Table Address	Type, in quotation marks [" "], the name of the tag in the ControlLogix controller (for example, "count").
		MultiHop	Select Yes.
SLC 500	This Controller	Communication Command	PLC5 Read or PLC5 Write
		Data Table Address	Starting address of the data in the SLC 500 controller
		Size in Elements	Number of elements to read or write
		Channel	1
	Target Device	Data Table Address	Type, in quotation marks [" "], the name of the tag in the ControlLogix controller (for example, "count").
		MultiHop	Select Yes

2. On the MultiHop tab, specify the following:
  - IP address of the EtherNet/IP communication module that is local to the Logix5000 controller
  - Slot number of the Logix5000 controller

## Send Email

This chapter describes how to send an email through an EtherNet/IP communication module.

---

**IMPORTANT** The 1756-EN2TSC module does not support this capability.

---

Topic	Page
EtherNet/IP Communication Module as an Email Client	71
Send Email via a Controller-initiated Message Instruction	73
Create String Tags	73
Enter the Ladder Logic	76
Configure the MSG Instruction that Identifies the Mail Relay Server	76
Configure the MSG Instruction That Contains the Email Text	78
Enter Email Text	80
Possible Email Status Codes	80

For email, the EtherNet/IP communication module can be remote or local to the controller.

### EtherNet/IP Communication Module as an Email Client

The EtherNet/IP communication module is an email client that uses a mail relay server to send email.

---

**IMPORTANT** The EtherNet/IP communication module can send an email to only one recipient at a time. It cannot mail to a distribution list.

---

**Table 16 - Ethernet Email**

Desired Action	Required Tasks
Send an email to specific personnel when a controller application generates an alarm or reaches a certain condition	Program the controller to send a MSG instruction to the EtherNet/IP communication module The MSG instruction then instructs the EtherNet/IP communication module to send the email text (contained within the MSG instruction) to the mail relay server.
Send controller or application status information on a regular basis to a project manager	Multiple controllers can use the same EtherNet/IP communication module to initiate email.

The EtherNet/IP communication module sends only the content of a MSG instruction as an email to a mail relay server. Delivery of the email depends on the mail relay server. The EtherNet/IP communication module does not receive email.

**Figure 8 - Sample System**

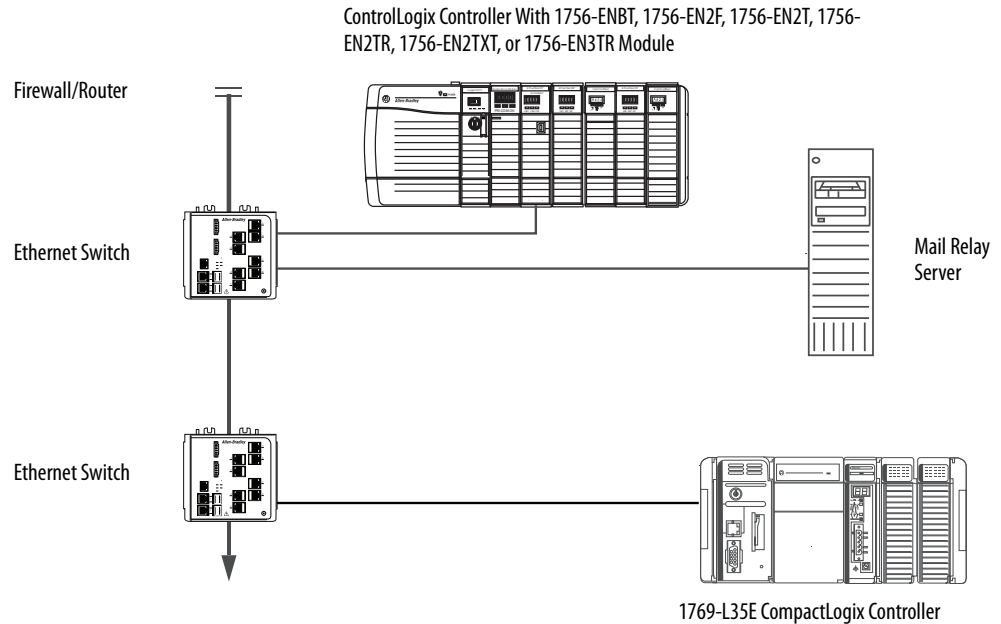

**Table 17 - Sample System Capabilities**

Device	Capability
ControlLogix controller	Send a MSG instruction to the 1756-ENBT module to initiate sending an email to the mail relay server.
CompactLogix controller	Use the path of the MSG instruction to identify the 1756-ENBT module as the target of the MSG instruction.
1756-ENBT, 1756-EN2F, 1756-EN2T, 1756-EN2TR, 1756-EN2TXT, EN2TRXT, or 1756-EN3TR module	Send an email to the mail relay server from the email interface on the Send an Email link. This interface requires entry of all email information.
Mail relay server	Send email to specified recipients. The mail relay server determines the delivery of any email sent through an EtherNet/IP communication module, whether via a MSG instruction or from its built-in interface.



## Send Email via a Controller-initiated Message Instruction

A Logix controller can send a generic CIP message instruction to the EtherNet/IP communication module that instructs the module to send an email message to a SMTP mail relay server using the standard SMTP protocol. This automatically communicates controller data and application conditions to appropriate personnel.

---

**IMPORTANT** Be careful to write the ladder logic to be sure the MSG instructions are not continuously triggered to send email messages.

---

Some mail relay servers require a domain name be provided during the initial handshake of the SMTP session. For these mail relay servers, specify a domain name when configuring the EtherNet/IP communication module's network settings.

For additional information, see [Configure an EtherNet/IP Communication Module to Operate on the Network on page 17](#).

## Create String Tags

You need three controller-scoped string tags. Each tag performs one of these functions:

- Identifies the mail server
- Contains the email text
- Contains the status of the email transmission

The default STRING data type supports up to 82 characters. In most cases, this is sufficient to contain the address of the mail server. For example, to create tag EmailConfigstring of type STRING, follow these steps.

1. Click **...** in the Value column of the Controller Tags dialog box.

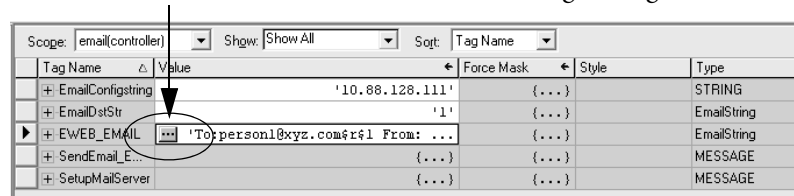

The String Browser dialog box appears.

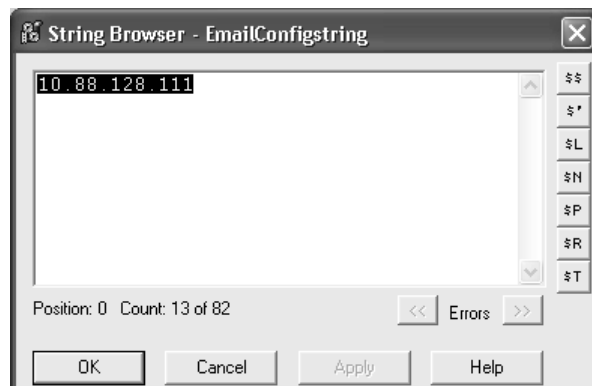

2. Type the IP address or host name of the mail server.
3. Click OK.

The tags for the email text and transmission status can contain up to 474 characters. For these tags, you must create a user-defined STRING data type. The default STRING data type in the Studio 5000 environment is not large enough for most email text.

To create a user-defined STRING data type, follow these steps.

1. In the Data Types folder in the Studio 5000 environment, navigate to and right-click the Strings folder, and choose New String Type.

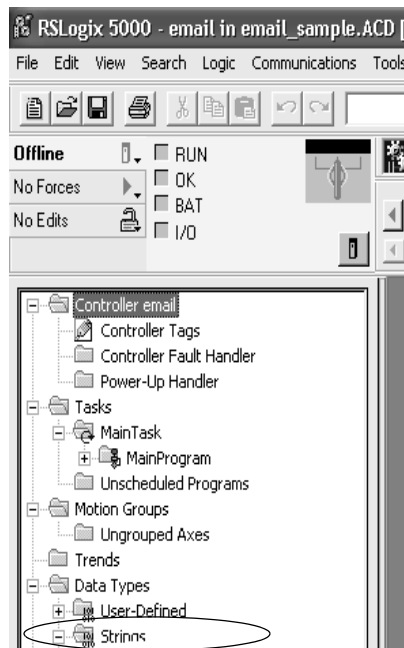

## 2. Create the EmailString data type.

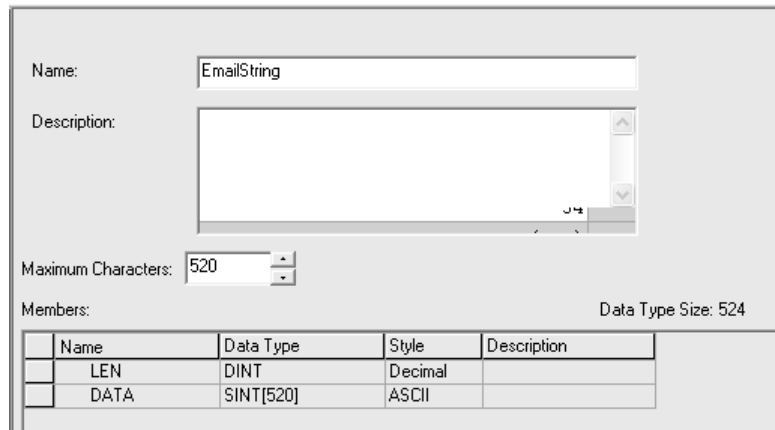

Name: EmailString

Description:

Maximum Characters: 520

Members: Data Type Size: 524

Name	Data Type	Style	Description
LEN	DINT	Decimal	
DATA	SINT[520]	ASCII	

## 3. Create one controller-scoped tag, such as EWEB\_EMAIL, of this new data type to contain the email text.

## 4. Create a second controller-scoped tag, such as EmailDstStr, of this new data type to contain the transmission status.

Both of these tags are of type EmailString.

## 5. Click ... in the Value column of the Controller Tags dialog box.

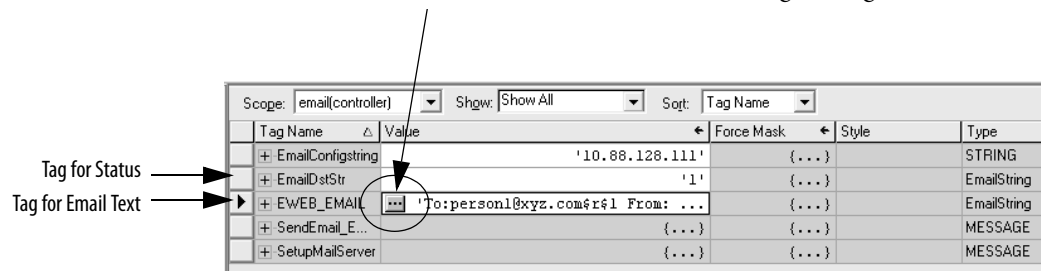

The String Browser dialog box appears.

## 6. Type your email.

The text of the email does not have to be static. You can program a controller project to collect specific data to be sent in an email.

## 7. Click OK.

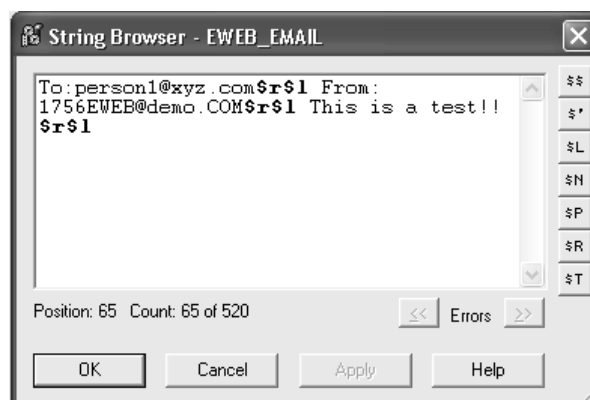

For more information on using ladder logic to manipulate string data, see the Logix5000 Controllers Common Procedures Programming Manual, publication [1756-PM001](#).

### Enter the Ladder Logic

Ladder logic requires two MSG instructions. One MSG instruction configures the mail server and needs to be executed only once. The second MSG instruction triggers the email. Execute this email MSG instruction as often as needed.

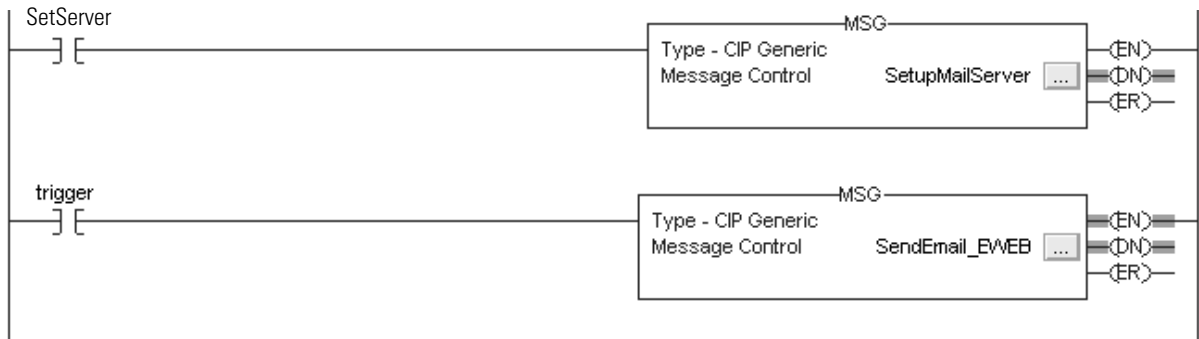

The first rung configures the mail server. The second rung sends the email text.

### Configure the MSG Instruction that Identifies the Mail Relay Server

To configure the MSG instruction that identifies the mail relay server, follow these steps.

1. In the MSG instruction, click the Communication tab.

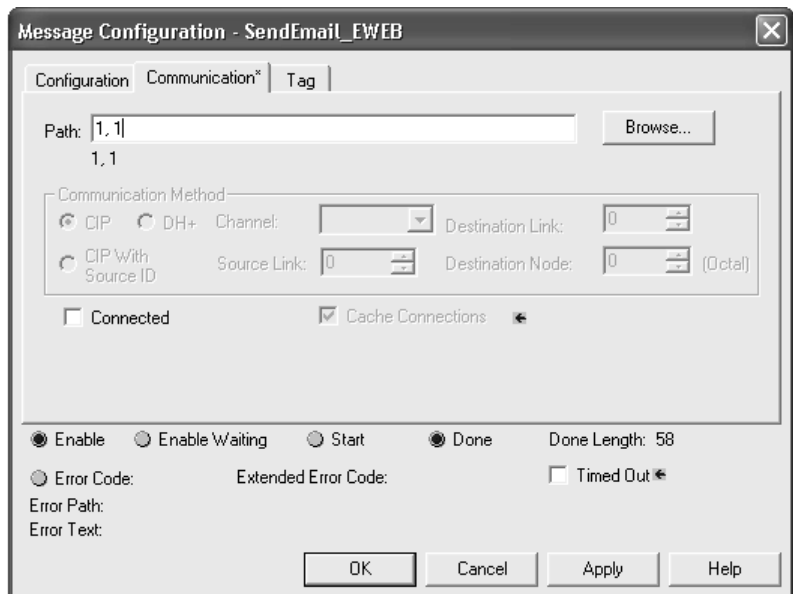

- In the Path field, type the path for the MSG instruction. The path starts with the controller initiating the MSG instruction.

Type the number of the port from which the message exits and the address of the next module in the path.

For example, if the EtherNet/IP communication module is in the same chassis as the controller and is in slot 2, the path is: 1, 2.

For more information on configuring the path of a MSG instruction, see the Logix5000 Controllers General Instructions Reference Manual, publication [1756-RM003](#).

- Click the Configuration tab.
- Configure the MSG parameters for sending an email.
  - From the Service Type pull-down menu, choose Attribute Single
  - In the Instance field, type 1.
  - In the Class field, type 32f.
  - In the Attribute field, type 5.
  - From the Source Element pull-down menu, choose the tag that contains your email text.
  - In the Source Length field, type the number of characters in the email plus four.

In this example, you would enter 13 for the number of characters plus 4 for a total of 17.

The Source Length is the number of characters in the STRING tag that identifies the mail relay server plus 4 characters. In this example, the tag contains 13 characters.

The screenshot shows the 'Message Configuration - SetupMailServer' dialog box. The 'Configuration' tab is selected. The 'Message Type' is 'CIP Generic'. The 'Service Type' is 'Set Attribute Single'. The 'Source Element' is 'EmailConfigstring'. The 'Source Length' is '17 (Bytes)'. The 'Service Code' is '10 (Hex)', 'Class' is '32f (Hex)', 'Instance' is '1', and 'Attribute' is '5 (Hex)'. The 'Destination' field is empty. The 'Done' radio button is selected. The 'Error Code', 'Error Path', and 'Error Text' fields are empty. The 'OK', 'Cancel', 'Apply', and 'Help' buttons are at the bottom.

After the MSG instruction that configures the mail relay server executes successfully, the controller stores the mail relay server information in nonvolatile memory. The controller retains this information, even through power cycles, until another MSG instruction changes the information.

## Configure the MSG Instruction That Contains the Email Text

To configure the MSG instruction that contains the email text, perform this procedure.

1. Click the Configuration tab.

The Source Length is the number of characters in the email tag plus 4 characters.

In this example, the email text contains 65 characters.

2. Configure the MSG parameters for sending an email.
  - From the Service Type pull-down menu, choose Custom.
  - In the Service Code field, type 4b.
  - In the Instance field, type 1.
  - In the Class field, type 32f.
  - In the Attribute field, type 0.
  - From the Source Element pull-down menu, choose the tag that contains your email text.
  - In the Source Length field, type the number of characters in the email plus four.

In this example, you would enter 65 for the number of characters plus 4 for a total of 69.

- From the Destination pull-down menu, choose a tag to contain the status of your email transmission.

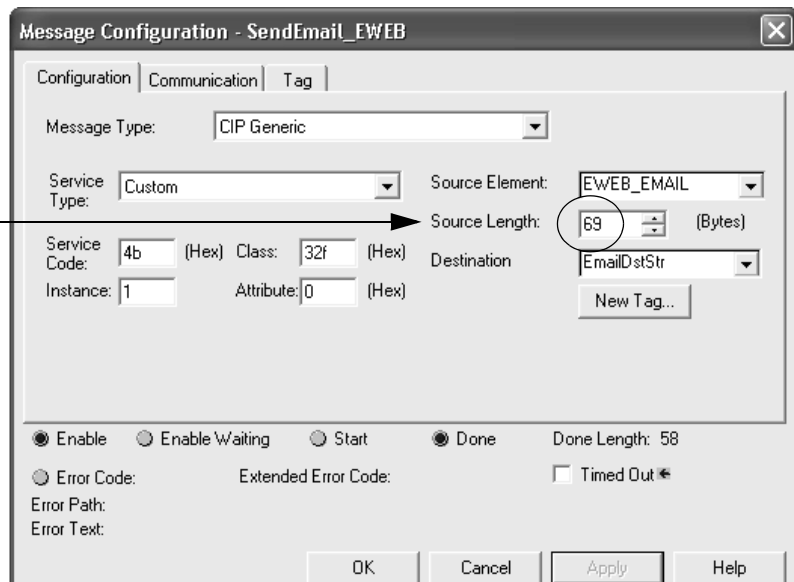

3. Click the Communication tab.

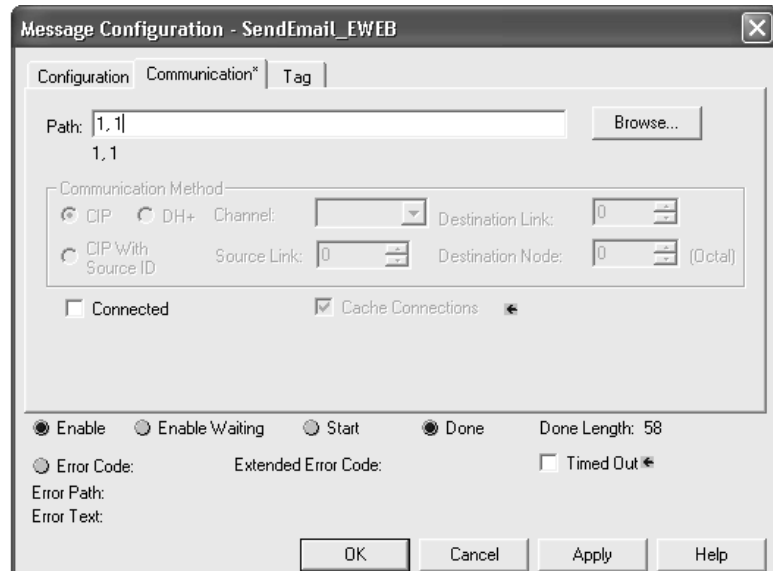

4. In the Path field, type the path from the controller to the EtherNet/IP communication module.

The path starts with the controller initiating the MSG instruction. The second number in the path represents the port from which the message exits and the address of the next module in the path.

For example, if the EtherNet/IP communication module is in the same chassis as the controller and is in slot 2, the path is: 1, 2.

5. If all the devices in the path are configured in the initiating controller's I/O Configuration tree, click Browse to select the target module.

The software automatically fills in the path.

6. Click OK.

For more information on configuring the path of an MSG instruction, see the Logix5000 Controllers General Instructions Reference Manual, publication [1756-RM003](#).

## Enter Email Text

Use the string browser to type the text of the email. To include To:, From:, and Subject: fields in the email, use <CR><LF> symbols to separate each of these fields. The To: and From fields are required; the Subject: field is optional. For example:

```
To: email address of recipient <CR><LF>
From: email address of sender <CR><LF>
Subject: subject of message <CR><LF>
body of email message
```

An email message must not exceed 474 characters in length. An additional 4-byte string-length value is added to the tag. As a result, the maximum source length is 478 characters.

## Possible Email Status Codes

Examine the destination element of the email MSG to see whether the email was successfully delivered to the mail relay server. A successful delivery indicates that the mail relay server placed the email message in a queue for delivery, but it does not mean the intended recipient received the email message. These are the possible codes that a destination element could contain.

**Table 18 - Email Status Code Descriptions**

Error Code (Hex)	Extended-error Code (Hex)	Description
0x00	None	Delivery successful to the mail relay server.
0x02	None	Resource unavailable. The email object was unable to obtain memory resources to initiate the SMTP session.
0x08	None	Unsupported Service Request. Make sure the service code is 0x4B and the Class is 0x32F.
0x11	None	Reply data too large. The Destination string must reserve space for the SMTP server reply message. The maximum reply can be 470 bytes.
0x13	None	Configuration data size too short. The Source Length is less than the Source Element string size plus the 4-byte length. The Source Length must equal the Source Element string size + 4.
0x15	None	Configuration data size too large. The Source Length is greater than the Source Element string size plus the 4-byte length. The Source Length must equal the Source Element string size + 4.
0x19	None	Data write failure. An error occurred when attempting to write the SMTP server address (attribute 4) to nonvolatile memory.
0xFF	0x0100	Error returned by email server; check the Destination string for reason. The email message was not queued for delivery.
	0x0101	SMTP mail server not configured. Attribute 5 was not set with a SMTP server address.
	0x0102	'To:' address not specified. Attribute 1 was not set with a 'To:' address AND there is not a 'To:' field header in the email body.
	0x0103	'From:' address not specified. Attribute 2 was not set with a 'From:' address AND there is not a 'From:' field header in the email body.



**Table 18 - Email Status Code Descriptions**

Error Code (Hex)	Extended-error Code (Hex)	Description
0xFF	0x0104	Unable to connect to SMTP mail server set in Attribute 5. If the mail server address is a host name, make sure that the device supports DNS, and that a Name Server is configured. If the host name is not fully qualified, for example, 'mailhost' and not 'mailhost.xx.yy.com' then the domain must be configured as 'xx.yy.com'. Try 'ping <mail server address>' to insure the mail server is reachable from your network. Also try 'telnet <mail server address> 25', which attempts to initiate a SMTP session with the mail server via telnet over port 25. (If you connect then type 'QUIT').
	0x0105	Communication error with SMTP mail server. An error occurred after the initial connection with the SMTP mail server. See the ASCII text following the error code for more details as to the type of error.
	0x0106	SMTP mail server host name DNS query did not complete. A previous send service request with a host name as the SMTP mail server address did not yet complete. Note that a timeout for a DNS lookup with an invalid host name can take up to 3 minutes. Long timeouts can also occur if a domain name or name server is not configured correctly.

**Notes:**

## Communicate with PanelView Terminals

This chapter describes how a controller uses an EtherNet/IP communication module to communicate with PanelView and PanelView Plus terminals over an EtherNet/IP network.

Topic	Page
Set Up the Hardware	83
Connections to PanelView Terminals	84
Add a PanelView Terminal	85
Organize Controller Data for a PanelView Terminal	89
Connections to FactoryTalk View Applications	89

### Set Up the Hardware

In this example, the controller in the local chassis shares data with an HMI application on the EtherNet/IP network. This application could be running these components:

- PanelView terminal
- PanelView Plus terminal
- Workstation running Factory Talk View software
- Workstation running a FactoryTalk Enterprise application, such as FactoryTalk View Machine Edition or FactoryTalk View Supervisory Edition

**Figure 9 - Ethernet Communication with PanelView Terminal**

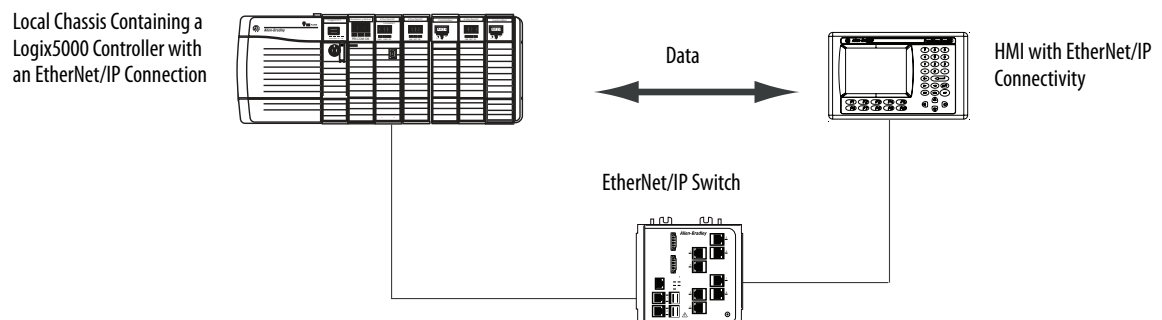

## Logix5000 Controller Combinations

Your controller type determines which communication module to use.

**Table 19 - Choosing a Communication Module**

Controllers	Communication Modules
ControlLogix	1756-ENBT, 1756-EN2F, 1756-EN2T, 1756-EN2TR, 1756-EN2TXT, 1756-EN3TR, 1756-EWEB, or 1756-EN2TSC communication modules
1769 CompactLogix	A built-in EtherNet/IP port on the controller.
1768 CompactLogix	1768-ENBT, 1756-EWEB EtherNet/IP communication modules
PowerFlex 700S with DriveLogix™	1788-ENBT EtherNet/IP communication module.

You must complete these tasks before your controller can communicate with PanelView terminals over an EtherNet/IP network:

- Set the IP addresses for the controller’s EtherNet/IP communication module and the HMI terminal.
- Connect all wiring and cabling.

## Connections to PanelView Terminals

To establish communication between a PanelView or PanelView Plus terminal, specify controller connections.

**Table 20 - PanelView Terminal Connections**

Type of Communication	Terminal Type	
	PanelView	PanelView Plus
Implicit (connected) <ul style="list-style-type: none"> <li>• Logix controller communicates to the PanelView terminal like an I/O module.</li> <li>• You must add the PanelView terminal to the I/O configuration tree for the controller project.</li> </ul>	Supported	Not supported
Explicit (unconnected) <ul style="list-style-type: none"> <li>• Communication is set up in PanelBuilder® or RSView® ME software.</li> <li>• All communication is initiated by the PanelView or PanelView Plus terminal.</li> </ul>	Supported	Supported

When communicating implicitly (PanelView terminals only), the controller uses one connection for each terminal. Account for these connections when designing the system. Logix5000 controllers support these numbers of connections:

- Firmware revisions 11 and earlier support up to 16 bidirectional implicit buffers (connections).
- Firmware revisions 12 or later support up to 32 bidirectional implicit buffers (connections).

The larger number of implicit buffers enables significantly more PanelView terminals to simultaneously request data from the controller via implicit communication.

When communicating explicitly, the controller supports 40 outgoing and 3 incoming buffers. This number of incoming buffers limits how many terminals can simultaneously request data from a controller via explicit communication. In other words, while a system can have multiple terminals, only three terminals can explicitly request data from a Logix controller at the same time.

## Add a PanelView Terminal

To add a PanelView terminal, follow these steps.

1. In the Controller Organizer, right-click I/O Configuration and choose New Module.

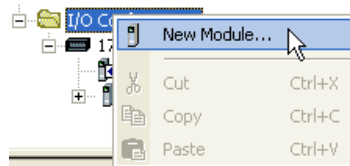

The Select Module dialog box appears.

2. Click the By Category tab.
3. Choose your EtherNet/IP communication module and click OK.

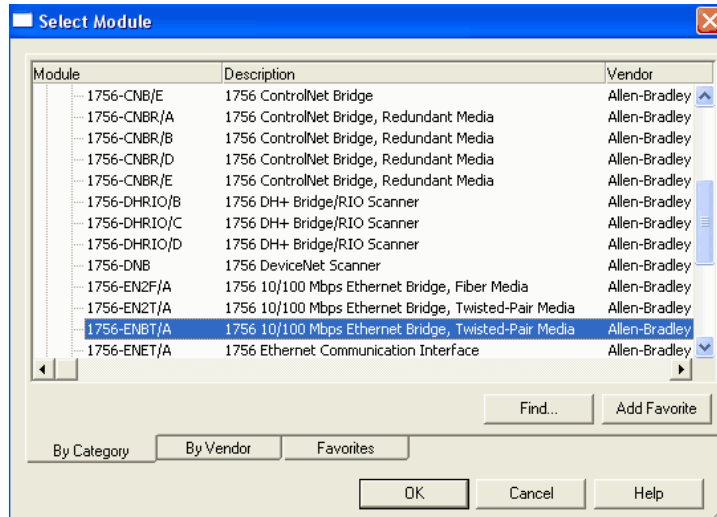

Depending on the EtherNet/IP communication module, the Select Major Revision dialog box may appear. If the dialog box appears, choose the module's major revision and click OK.

The New Module dialog box appears.

4. Configure your new module.
  - In the Name field, type the name of your module.
  - In the IP Address field, type the module IP address.
  - In the Slot field, type the chassis slot number.
  - Click Change to configure these parameters:
    - Module Revision
    - Electronic Keying
    - Communication Format
5. Click OK.

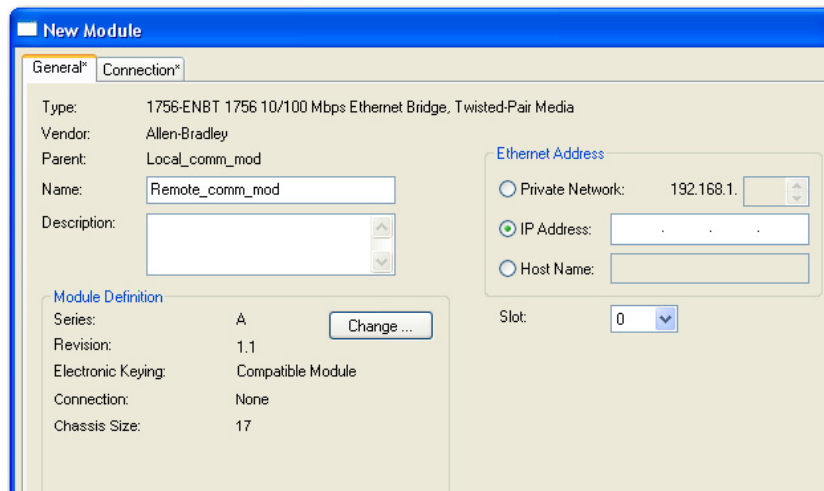

**IMPORTANT** The number and type of configuration parameters on the New Module dialog box varies according to the EtherNet/IP communication module type.

6. In the Controller Organizer, right-click the local EtherNet/IP communication module you just added and choose New Module.

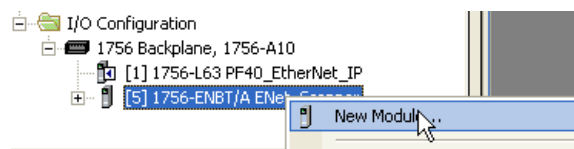

The Select Module Type dialog box appears.

7. Click the By Category tab.
8. Choose the EtherNet/IP PanelView terminal and click OK.

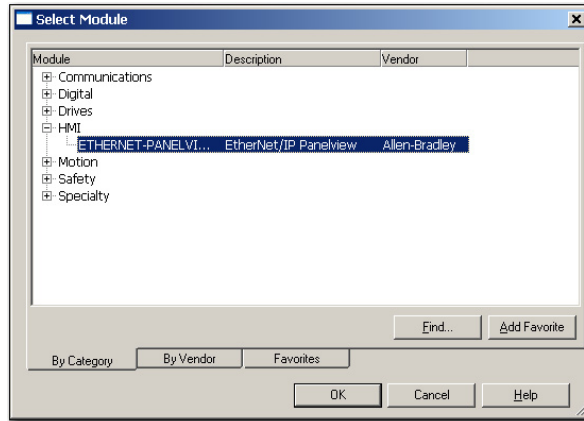

The Module Properties dialog box appears.

9. Configure the PanelView terminal.
  - In the Name field, type the name of your new module.
  - From the Comm Format pull-down menu, choose Data-DINT.
  - From the Electronic Keying pull-down menu, choose Disable Keying.
  - In the IP Address field, type the IP address.
  - In the Input and Output fields, type the connection parameters.

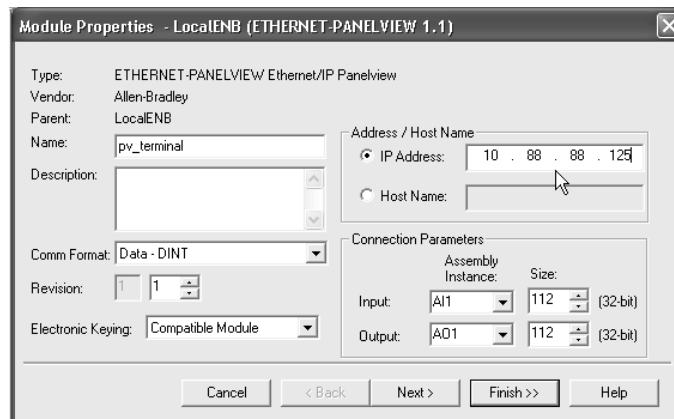

**IMPORTANT**

You can establish up to eight different instances with each terminal. For example, one controller can use all eight instances or eight controllers can each use one instance.

10. Click Finish.



## Organize Controller Data for a PanelView Terminal

Organize data for a PanelView terminal based on how the data is used.

**Table 21 - Controller Data Organization**

For data that is	Do this
Time critical (for example, data that controls a machine)	Use the I/O tags of the terminal. The tags for this data were created when you added the terminal to the I/O configuration of the controller. They resemble the I/O modules' tags.
Not time critical	Create arrays to store the data. 1. For each screen, create a BOOL array with enough elements for the bit-level objects on the screen. For example, the BOOL[32] array gives you 32 bits for push buttons or indicators. 2. For each screen, create a DINT array with enough elements for the word-level objects on the screen. For example, the DINT[28] array provides 28 values for numeric entry controls or numeric displays.

To access the I/O tags of the PanelView or PanelView Plus terminal, use the following address format.

Terminal Function	Requirement
Writes the data	name_of_terminal:I.Data[x].y
Reads the data	name_of_terminal:O.Data[x].y

This address variable	Is
name_of_terminal	Name of the instance in the I/O configuration of the controller.
x	Element of the input (I) or output (O) structure.
y	Bit number within the input or output element.

## Connections to FactoryTalk View Applications

To establish communication to a FactoryTalk View application, configure RSLinx software to collect tags from the controller. A FactoryTalk View or FactoryTalk View Enterprise application uses RSLinx software as a data server.

RSLinx Enterprise software defaults to four read connections and one write connection per configured controller. Modify the RSLinx software configuration as needed.

**Notes:**

## Diagnostic Web Pages

Some EtherNet/IP communication modules provide diagnostic web pages

Topic	Page
Access Web Browser Support	92
1756-EN2TR Module	93
Diagnostic Overview Page	93
Ethernet Statistics Web Page	95
Connection Manager Cmd Object Info Web Page	96
Ring Statistics Web Page	97
1756-ENBT Module	98
Diagnostic Overview Page	98
Ethernet Statistics	100
1769-AENTR Adapter	101
Diagnostic Overview Page	101
Ethernet Statistics	103

The number and type of diagnostic fields vary by module catalog number. This chapter describes the diagnostic web pages on these modules:

- 1756-EN2TR EtherNet/IP communication module
- 1756-ENBT EtherNet/IP communication module

---

**IMPORTANT** The diagnostic web pages have many fields you can use to monitor your EtherNet/IP module's operating state. This section describes only the fields most commonly used during monitoring.

To troubleshoot problems you diagnose as a result of monitoring the EtherNet/IP modules' diagnostic web pages, refer to publication [ENET-AT003](#), Troubleshoot EtherNet/IP Networks.

---

## Access Web Browser Support

To troubleshoot most possible problems with your EtherNet/IP communication module, you need to access the module’s diagnostic web pages.

**IMPORTANT** The number and type of diagnostic fields vary by module catalog number, the Studio 5000 environment version and module firmware revision.

For example, this chapter describes the diagnostic web pages for these modules:

- 1756-EN2TR EtherNet/IP communication module
- 1756-ENBT EtherNet/IP communication module

To access your EtherNet/IP communication module diagnostic web pages, follow these steps.

1. Open your web browser.
2. In the Address field, type your EtherNet/IP communication module internet protocol (IP) address and press Enter.

The diagnostic web home page appears.

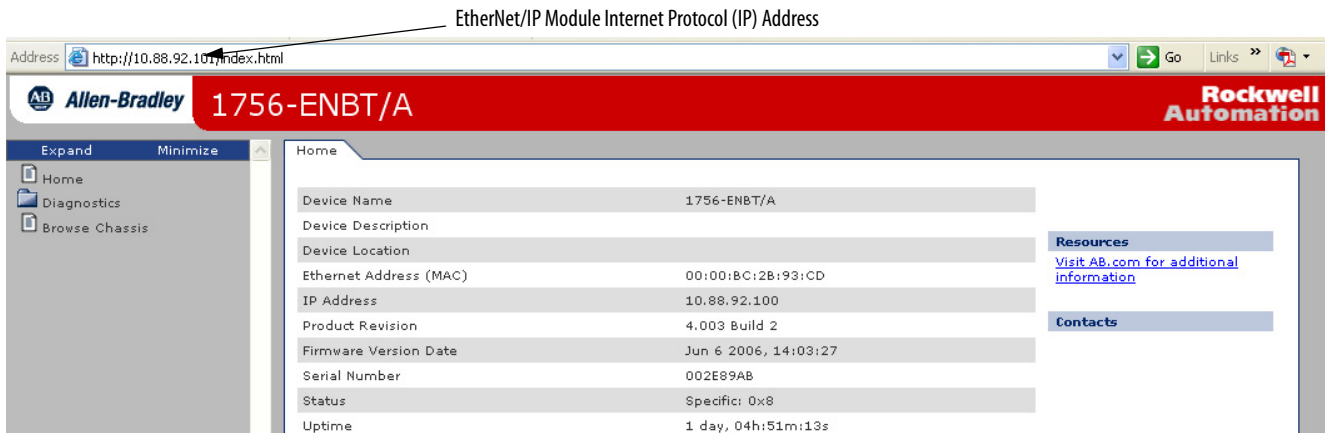

3. Open the Diagnostics folder in the left-most navigation bar and click the link for each diagnostic web page you need to monitor.

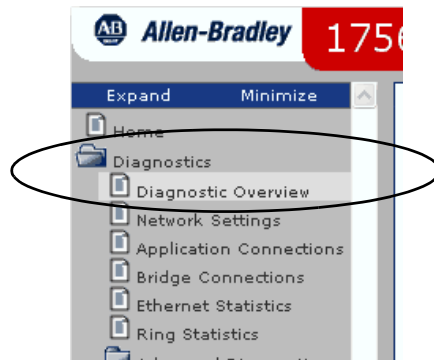

## 1756-EN2TR Module

These are the most commonly used diagnostic web pages for the 1756-EN2TR module:

- Diagnostic Overview Page
- Ethernet Statistics Web Page
- Ring Statistics Web Page

**IMPORTANT** The 1756-EN2TR module also offers these diagnostic web pages for monitoring the module:

- Network Settings
- Application Connections
- Bridge Connections

These web pages are not as commonly used as the three described in this section and are not described here.

### Diagnostic Overview Page

The Diagnostic Overview web page presents a summary of the current configuration and overall status of the module.

The most commonly monitored fields are circled in the graphic and described in the table that follows.

The screenshot displays the Diagnostic Overview page for the 1756-EN2TR/A module. The page is organized into several sections, each with a table of metrics. The following table summarizes the data shown in the screenshot, with the most commonly monitored fields circled in red.

Section	Metric	Value
Module Resource Utilization (All Ports)	CPU	0.0 %
	I/O Comms Utilization (Actual)	1.3 %
	I/O Comms Utilization (Theoretical)	1.3 %
	Actual Rate (I/O PPS)	758
CIP Connection Statistics (All Ports)	Active Total	4
	Active Messaging	1
	Active I/O	3
	Maximum Total Observed	7
TCP Connections (EtherNet/IP Port)	Active	2
	Maximum Observed	2
	Maximum Supported	128
Web Server	Page Hits	886
	Form Hits	0
CIP Unconnected (EtherNet/IP Port)	Sent Packets Per Second	0
	Received Packets Per Second	0
	Sent Packet Count	89
	Received Packet Count	89
HMI/MSG (EtherNet/IP Port - Class 3)	Sent Packets Per Second	3
	Received Packets Per Second	3
	Sent Bytes Per Second	1500
	Received Bytes Per Second	556
I/O and Prod/Cons Packets Per Second (EtherNet/IP Port - Class 1)	Total	379
	Sent	189
	Received	190
I/O and Prod/Cons Packet Counts (EtherNet/IP Port - Class 1)	Total	164183
	Sent	81914
	Received	82269
	Missed	0
Multicast Producers (EtherNet/IP Port - Class 1)	Active	0
	Maximum Observed	0
	Maximum Supported	32
	Base Address	239.192.28.0

This table describes the fields most commonly used on the Diagnostics Overview web page.

**Table 22 - Diagnostic Overview Web Page**

Field	Specifies
<b>Module Resource Utilization (All Ports)</b>	
CPU	Current percent CPU utilization for the module
<b>CIP Connection Statistics (All Ports)</b>	
Active Total	Total number of active CIP connections used for both messaging and I/O
<b>TCP Connections (EtherNet/IP Port)</b>	
Active	Number of active TCP connections for CIP messaging
<b>HMI/MSG (EtherNet/IP Port - Class 3)</b>	
Sent packets per second	Number of Class 3 TCP packets sent in the last one-second snapshot
Received packets per second	Number of Class 3 TCP packets received in the last one-second snapshot
<b>I/O and Prod/Cons Packets Per Second (EtherNet/IP Port - Class 1)</b>	
Total	Total number of Class 1 UDP packets sent and received
<b>I/O and Prod/Cons Packets Count (EtherNet/IP Port - Class 1)</b>	
Missed	Number of Class 1 UDP packets missed

## Ethernet Statistics Web Page

The Ethernet Statistics web page provides a summary of the status of communication activity on the Ethernet network.

The most commonly monitored fields are circled in the graphic and described in the table that follows.

The screenshot shows the Ethernet Statistics web page for an Allen-Bradley 1756-EN2TR/A device. The page is divided into several sections:

- Ethernet Port 1:** Interface State (Enabled), Link Status (Active), Speed (100 Mbps), Duplex (Full Duplex), Autonegotiate Status (Autonegotiate Speed and Duplex).
- Ethernet Port 2:** Interface State (Enabled), Link Status (Active), Speed (100 Mbps), Duplex (Full Duplex), Autonegotiate Status (Autonegotiate Speed and Duplex).
- Media Counters Port 1:** Alignment Errors (0), FCS Errors (0), Single Collisions (0), Multiple Collisions (0), SQE Test Errors (0), Deferred Transmissions (0), Late Collisions (0), Excessive Collisions (0), MAC Transmit Errors (0), Carrier Sense Errors (0), Frame Too Long (0), MAC Receive Errors (0).
- Media Counters Port 2:** Alignment Errors (0), FCS Errors (0), Single Collisions (0), Multiple Collisions (0), SQE Test Errors (0), Deferred Transmissions (0), Late Collisions (0), Excessive Collisions (0), MAC Transmit Errors (0), Carrier Sense Errors (0), Frame Too Long (0), MAC Receive Errors (0).
- Interface Counters:** In Octets (12946511), In Ucast Packets (34336), In NUcast Packets (93062), In Discards (0), In Errors (0), In Unknown Protos (0), Out Octets (12241395), Out Ucast Packets (124704), Out NUcast Packets (27), Out Discards (0), Out Errors (0).

This table describes the field most commonly used on the Ethernet Statistics web page.

**Table 23 - Ethernet Statistics Web Page**

Field	Specifies
<b>Ethernet Port 1 (These definitions apply to the same fields in the Ethernet Port 2 section.)</b>	
Interface State	Whether the port is turned off or on. Active or inactive indicates whether there is a cable connected.
Link Status	Whether the port is blocked for DLR protocol frames.
Speed	Whether the Ethernet port is operating at 10 or 100 MBps.
Duplex	Whether the Ethernet port is operating at half duplex or full duplex.
Autonegotiate Status	Whether the port speed and Duplex mode were determined via autonegotiation or whether they were manually configured.

**Table 23 - Ethernet Statistics Web Page**

Field	Specifies
<b>Media Counters Port 1</b>	
Alignment Errors	A frame containing bits that do not total an integral multiple of eight.
FCS Errors	A frame containing eight bits, at least one of which has been corrupted.
Single Collisions	The number of outgoing packets that encountered only one collision during transmission.
Multiple Collisions	The number of outgoing packets that encountered 2...15 collisions during transmission.
SQE Test Errors	A test to detect the collision-present circuit between a transceiver and a network interface card (NIC). <b>IMPORTANT:</b> Because most NICs now have an integrated transceiver, the SQE test is unnecessary. Ignore this media counter.
Deferred Transmissions	The number of outgoing packets whose transmission is deferred because the network is busy when the first attempt is made to send them.
Late Collisions	The number of times two devices transmit data simultaneously.
Excessive Collisions	The number of frames that experience 16 consecutive collisions.
MAC Transmit Errors	Frames for which transmission fails due to an internal MAC sublayer transmit error.
Carrier Sense Errors	Times that the carrier sense condition was lost or never asserted when attempting to transmit a frame.
Frame Too Long	The number of incoming packets that exceed the maximum Ethernet packet size.
MAC Receive Errors	Frames for which reception on the Ethernet interface failed due to an internal MAC sublayer receive error.

### Connection Manager Cmd Object Info Web Page

The Connection Manager Cmd Object Info web page provides a summary of connection request activity on the Ethernet network.

The most commonly used field on this page is **Connections Closed due to a Timeout**. This field shows the number of CIP connection timeouts that have occurred on the module.

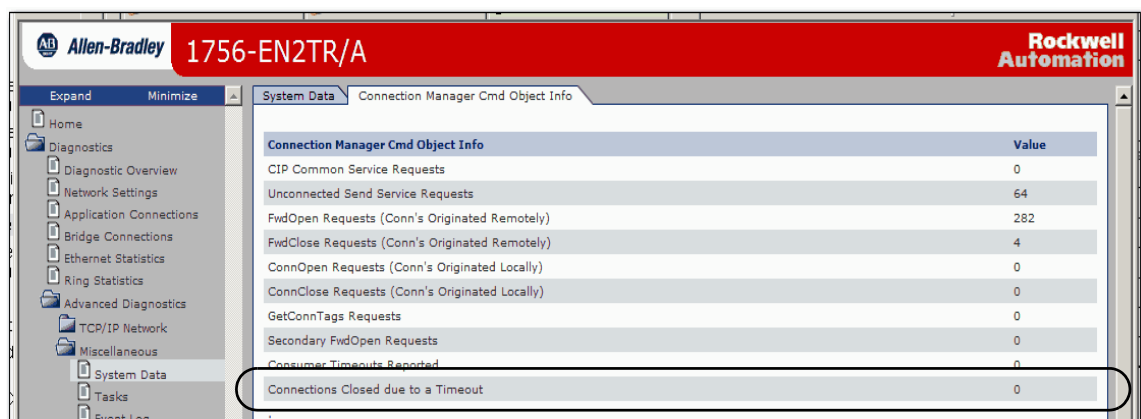



## Ring Statistics Web Page

**IMPORTANT** The Ring Statistics web page, and the descriptions in this section, only apply to modules you can use in a Device-level Ring (DLR) network:

- 1756-EN2TR communication module
- 1756-EN3TR communication module

The Ring Statistics web page provides a summary of the module's operating state in a DLR application.

The most commonly monitored fields are circled in the graphic and described in the table that follows.

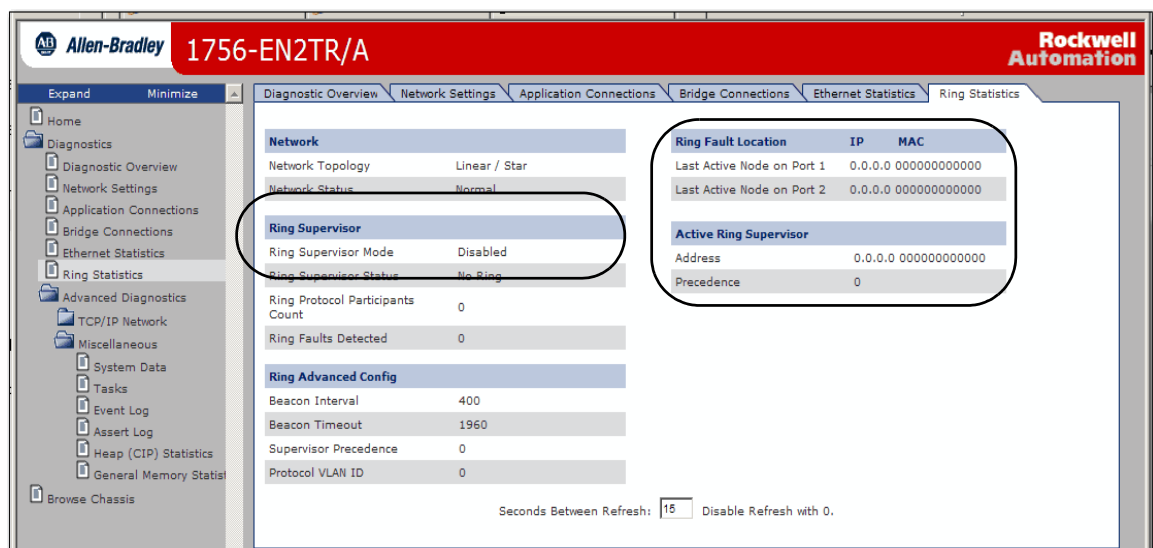

This table describes the field most commonly used on the Ring Statistics web page.

**Table 24 - Ring Statistics Web Page**

Field	Specifies
<b>Ring Supervisor</b>	
Ring Supervisor Mode	Whether a module is configured to function as supervisor node or a ring node.
Ring Supervisor Status	Whether a module that is configured to function as a supervisor node is functioning as the active ring supervisor or a backup supervisor node.
<b>Ring Fault Location</b>	
Last Active Node on Port 1	The IP or MAC ID address of the last active node between port 1 on the module and the faulted part of the network.
Last Active Node on Port 2	The IP or MAC ID address of the last active node between port 2 on the module and the faulted part of the network.
<b>Active Ring Supervisor</b>	
Address	The IP or MAC ID address of the active ring supervisor.
Precedence	The precedence value of the module. If the active supervisor node's operation is interrupted the backup supervisor with the next highest precedence value becomes the active supervisor node.

## 1756-ENBT Module

These are the most commonly used diagnostic web pages for the 1756-ENBT module:

- Diagnostic Overview Page
- Ethernet Statistics

**IMPORTANT** The 1756-ENBT module also offers these diagnostic web pages for monitoring the module:

- Network Settings
- Message Connections
- I/O Connections

These web pages are not as commonly used as the three described in this section and are not described here.

### Diagnostic Overview Page

The Diagnostic Overview web page presents a summary of the current configuration and overall status of the module. The most commonly monitored fields are circled in the graphic and described in the table that follows.

The screenshot shows the Diagnostic Overview page for the 1756-ENBT/A module. The page is divided into several sections, each with a table of metrics. The following table summarizes the data from the 'CIP Connection Statistics' section, where several values are circled in the original image:

CIP Connection Statistics	
Current CIP Msg Connections	0
CIP Msg Connection Limit	128
Max Msg Connections Observed	0
Current CIP I/O Connections	0
CIP I/O Connection Limit	128
Max I/O Connections Observed	0
Conn Opens	1
Open Errors	0
Conn Closes	0
Close Errors	0
Conn Timeouts	0

Other circled values in the screenshot include: Ethernet Link Speed (100 Mbps), Duplex (Full Duplex), Autonegotiate Status (Autonegotiate Speed and Duplex), CPU (0.20%), Current TCP Connections (0), Total I/O Packet/Second (0), and Missed I/O Packet Counter (0).

**Table 25 - Diagnostic Overview Web Page**

<b>Field</b>	<b>Specifies</b>
<b>Ethernet Link</b>	
Speed	Whether the Ethernet port is operating at 10 Mbps or 100 Mbps.
Duplex	Whether the Ethernet port is operating at half duplex or full duplex.
Autonegotiate Status	Whether the port speed and duplex mode were determined via autonegotiation or manual configuration.
<b>System Resource Utilization</b>	
	Number of times a page has been requested for which the user has insufficient privilege.
CPU	Current percent CPU utilization for the module.
<b>CIP Connection Statistics</b>	
Current CIP MSG Connections	Current number of CIP connections for message.
Current CIP I/O Connections	Current number of CIP connections for I/O.
Conn Timeouts	Number of CIP connection timeouts.
<b>TCP Connections (CIP)</b>	
Current TCP Connections	Current number of active TCP connections for CIP messaging.
<b>I/O Packet / Second Statistics</b>	
Total	Total number of Class 1 UDP packets the module transmitted and received in the last one-second snapshot. The Total is the sum of the Sent, Received, Inhibited, and Rejected numbers.
<b>I/O Packet Counter Statistics</b>	
Missed	Cumulative number packets that were not received in order. Each UDP packet has a sequence number and if a packet is missing (corrupted or dropped), the module will recognize this void upon receipt of the next packet received.

## Ethernet Statistics

The Ethernet Statistics diagnostic web page presents a summary of the status of communication activity on the Ethernet network.

The most commonly monitored fields are circled in the graphic and described in the table that follows.

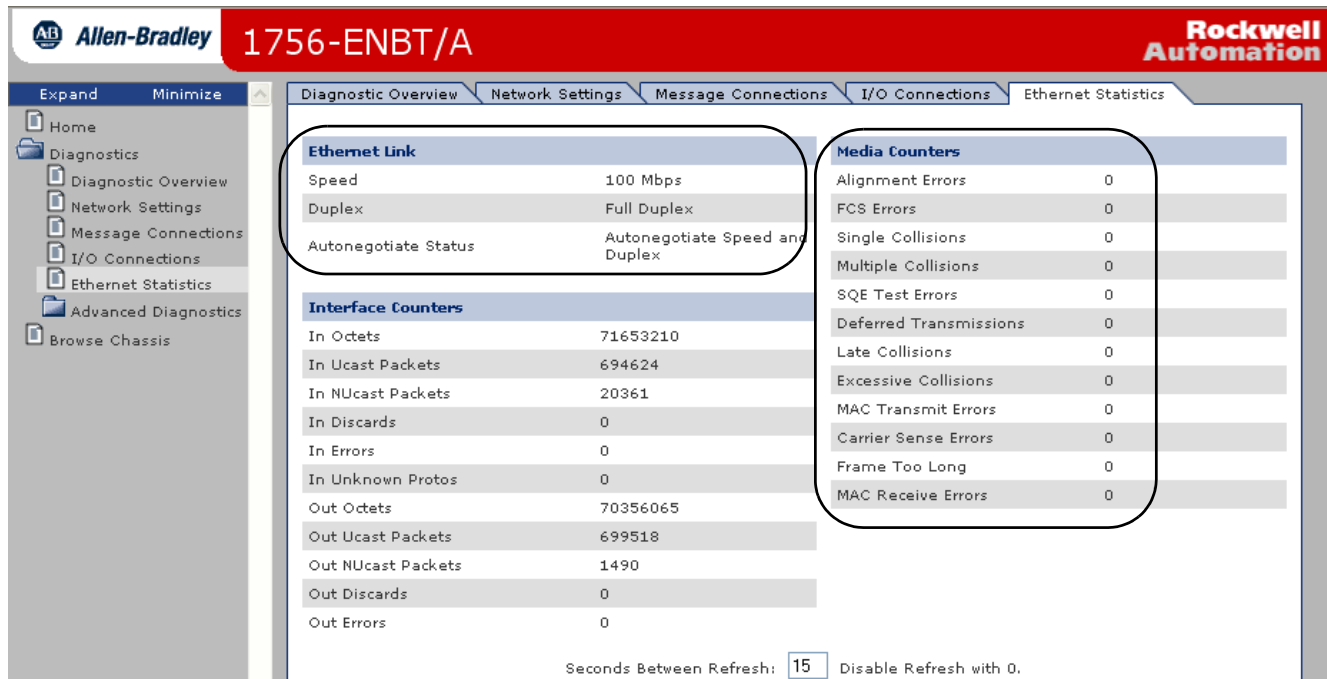

Table 26 - Ethernet Statistics Web Page

Field	Specifies
<b>Ethernet Link</b>	
Speed	Whether the Ethernet port is operating at 10 or 100 MBps.
Duplex	Whether the Ethernet port is operating at half duplex or full duplex.
Autonegotiate Status	Whether the port speed and Duplex mode were determined via autonegotiation or whether they were manually configured.
<b>Media Counters</b>	
Alignment Errors	A frame containing bits that do not total an integral multiple of eight.
FCS Errors	A frame containing eight bits, at least one of which has been corrupted.
Single Collisions	The number of outgoing packets that encountered only one collision during transmission.
Multiple Collisions	The number of outgoing packets that encountered 2...15 collisions during transmission.
SQE Test Errors	A test to detect the collision-present circuit between a transceiver and a network interface card (NIC). <b>Important:</b> Because most NICs now have an integrated transceiver, the SQE test is unnecessary. Ignore this media counter.
Deferred Transmissions	The number of outgoing packets whose transmission is deferred because the network is busy when the first attempt is made to send them.
<b>Media Counters</b>	
Late Collisions	The number of times two devices transmit data simultaneously.

**Table 26 - Ethernet Statistics Web Page**

Field	Specifies
Excessive Collisions	The number of frames that experience 16 consecutive collisions.
MAC Transmit Errors	Frames for which transmission fails due to an internal MAC sublayer transmit error.
Carrier Sense Errors	Times that the carrier sense condition was lost or never asserted when attempting to transmit a frame.
Frame Too Long	The number of incoming packets that exceed the maximum Ethernet packet size.
MAC Receive Errors	Frames for which reception on the Ethernet interface failed due to an internal MAC sublayer receive error.

## 1769-AENTR Adapter

These are the most commonly used diagnostic web pages for the 1769-AENTR adapter:

- Diagnostic Overview Page
- Ethernet Statistics

---

**IMPORTANT** The 1769-AENTR adapter also offers these diagnostic web pages for monitoring the adapter:

- Network Settings
- I/O Connections

These web pages are not as commonly used as the two described in this section and are not described here.

---

## Diagnostic Overview Page

The Diagnostic Overview web page presents a summary of the current configuration and overall status of the adapter. The most commonly monitored fields are circled in the graphic and described in [Table 27 on page 103](#).

Allen-Bradley **1769-AENTR**
Rockwell Automation

Expand Minimize

- Home
- Diagnosics
  - Diagnostic Overview
  - Network Settings
  - Ethernet Statistics
  - I/O Connections
- Configuration

Diagnostic Overview **Network Settings** Ethernet Statistics I/O Connections

Ring Status	
Network Topology	Linear
Network Status	Normal
Ring Supervisor	0.0.0.0 00:00:00:00:00:00
Beacon Interval	400
Beacon Timeout	1960

System Resource Utilization	
CPU Utilization	15%
Module Uptime	18 days, 22h:12m:43s

CIP Connection Statistics	
Current CIP Msg Connections	0
CIP Msg Connection Limit	32
Max Msg Connections Observed	0
Current CIP I/O Connections	4
CIP I/O Connection Limit	32
Max I/O Connections Observed	4
Conn Opens	425
Open Errors	92
Conn Closes	16
Close Errors	0
Conn Timeouts	192

TCP Connections	
Active	1
Maximum Observed	3
Maximum Supported	96

Module Settings	
Switches	169

1769 Backplane Statistics	
Backplane Status	OK
Scans Completed	301011954
Maximum Scan time	2 msec
Average Scan Time	2 msec

HMI/MSG Unconnected	
Sent Packet Count	450
Received Packet Count	450

HMI/MSG Connected (Class 3)	
Sent Packet Count	0
Received Packet Count	0

I/O and Prod/Cons Packets Per Second	
Total	278
Sent	162
Received	116
Rejected	0
Capacity (Approximate)	10000
Actual Reserve (Approximate)	9722
Theoretical Reserve (Approximate)	9721

## Ethernet Statistics

**Table 27 - Diagnostic Overview Web Page**

Field	Specifies
<b>Ring Status</b>	
Network Topology	Whether the Ethernet network is linear or DLR topology.
Network Status	Whether the Ethernet network is operating normally or otherwise.
Ring Supervisor	The IP and MAC address of the ring supervisor.
Beacon Interval	Beacon interval values. These values affect network recovery time. Use default values unless the ring includes more than 50 devices. For more information, refer to the EtherNet/IP Embedded Switch Technology Application Guide, publication <a href="#">ENET-AP005</a> .
Beacon Timeout	Beacon timeout values. These values affect network recovery time. Use default values unless the ring includes more than 50 devices. For more information, refer to the EtherNet/IP Embedded Switch Technology Application Guide, publication <a href="#">ENET-AP005</a> .
<b>System Resource Utilization</b>	
CPU	Current percent CPU utilization for the module.
<b>CIP Connection Statistics</b>	
Current CIP MSG Connections	Current number of CIP connections for message.
Current CIP I/O Connections	Current number of CIP connections for I/O.
Conn Timeouts	Number of CIP connection timeouts.
<b>TCP Connections (CIP)</b>	
Active	Current number of active TCP connections for CIP messaging.

The Ethernet Statistics diagnostic web page presents a summary of the status of communication activity on the Ethernet network.

The most commonly monitored fields are described in [Table 28 on page 104](#).

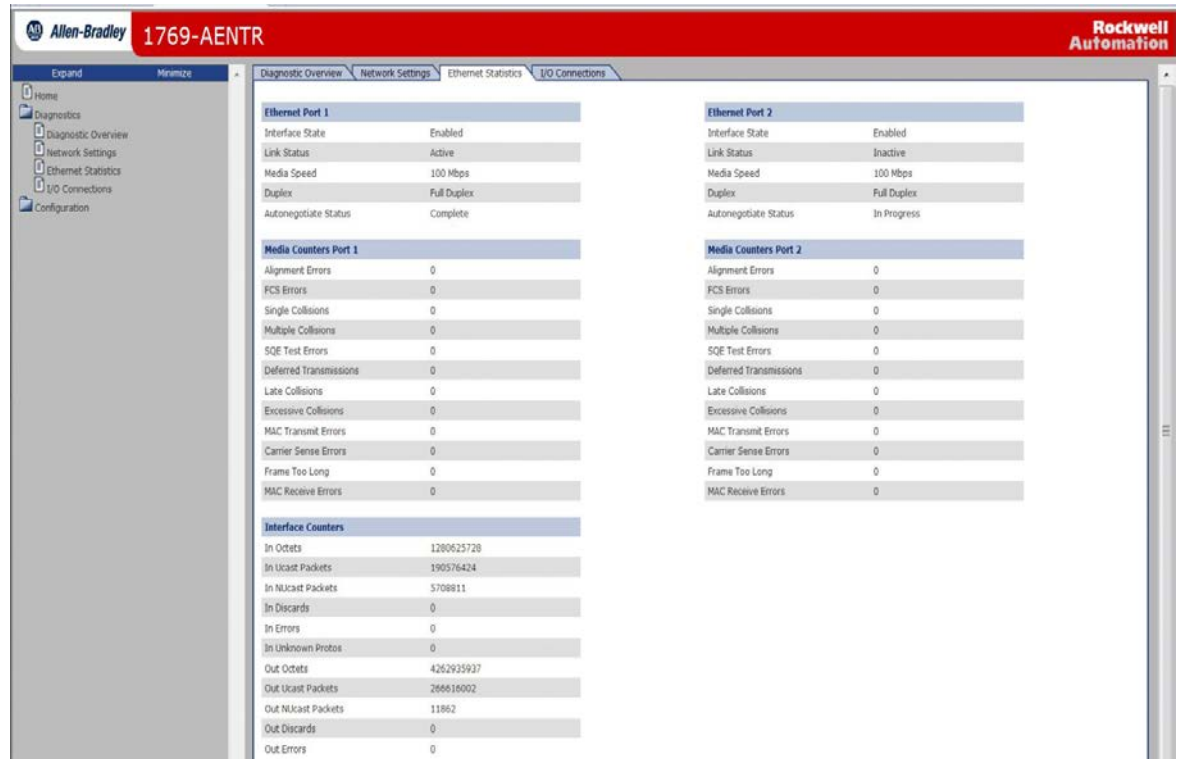

**Table 28 - Ethernet Statistics Web Page**

Field	Specifies
<b>Ethernet Port 1 (These definitions apply to the same fields in the Ethernet Port 2 section.)</b>	
Interface State	Whether the port is turned off or on. Active or inactive indicates whether there is a cable connected.
Link Status	Whether the port is blocked for DLR protocol frames.
Speed	Whether the Ethernet port is operating at 10 or 100 MBps.
Duplex	Whether the Ethernet port is operating at half duplex or full duplex.
Autonegotiate Status	Whether the port speed and Duplex mode were determined via autonegotiation or whether they were manually configured.



**Table 28 - Ethernet Statistics Web Page**

Field	Specifies
<b>Media Counters Port 1</b>	
Alignment Errors	A frame containing bits that do not total an integral multiple of eight.
FCS Errors	A frame containing eight bits, at least one of which has been corrupted.
Single Collisions	The number of outgoing packets that encountered only one collision during transmission.
Multiple Collisions	The number of outgoing packets that encountered 2...15 collisions during transmission.
SQE Test Errors	A test to detect the collision-present circuit between a transceiver and a network interface card (NIC). <b>IMPORTANT:</b> Because most NICs now have an integrated transceiver, the SQE test is unnecessary. Ignore this media counter.
Deferred Transmissions	The number of outgoing packets whose transmission is deferred because the network is busy when the first attempt is made to send them.
Late Collisions	The number of times two devices transmit data simultaneously.
Excessive Collisions	The number of frames that experience 16 consecutive collisions.
MAC Transmit Errors	Frames for which transmission fails due to an internal MAC sublayer transmit error.
Carrier Sense Errors	Times that the carrier sense condition was lost or never asserted when attempting to transmit a frame.
Frame Too Long	The number of incoming packets that exceed the maximum Ethernet packet size.
MAC Receive Errors	Frames for which reception on the Ethernet interface failed due to an internal MAC sublayer receive error.

**Notes:**

## History of Changes

Topic	Page
ENET-UM001M-EN-P, November 2014	107
ENET-UM001L-EN-P, March 2014	108
ENET-UM001K-EN-P, February 2013	108
ENET-UM001J-EN-P, May 2011	108
ENET-UM001I-EN-P, January 2010	108
ENET-UM001H-EN-P, September 2009	108
ENET-UM001G-EN-P, November 2008	109
ENET-UM001F-EN-P, November 2006	109
ENET-UM001E-EN-P, January 2006	109
ENET-UM001D-EN-P, July 2005	109
ENET-UM001C-EN-P, October 2004	109
ENET-UM001B-EN-P, June 2004	110

This appendix summarizes the revisions to this manual. Reference this appendix if you need information to determine what changes have been made across multiple revisions. This may be especially useful if you are deciding to upgrade your hardware or software based on information added with previous revisions of this manual.

### ENET-UM001M-EN-P, November 2014

Change
Updated the Additional Resources
Added port setting considerations
Added section on electronic keying
Updated information regarding the Device-level Ring Network
Updated diagnostic troubleshooting references
Added information on accessing web pages

## ENET-UM001L-EN-P, March 2014

---

### Change

Added the 1769-AENTR to system-level figures

Added information about the 1769-AENTR diagnostic web pages

Added information about troubleshooting the 1769-AENTR with the web pages

---

## ENET-UM001K-EN-P, February 2013

---

### Change

Added references to 1756-EN2TSC and 1756-EN2TRTXT modules

Replaced references to RSLogix 5000 software with references to the Studio 5000 environment

Added latest 1769-Lx CompactLogix controllers

Made minor changes to procedures for sending email

---

## ENET-UM001J-EN-P, May 2011

---

### Change

Updated EtherNet/IP Overview section

Updated Configure a Supervisor on a Device level Ring Network section

Removed these sections:

- EtherNet/IP Network Specifications
  - EtherNet/IP Network Connections
  - EtherNet/IP Network Overview
  - Monitor Diagnostics
  - Troubleshoot an EtherNet/IP Module
  - USB Serial Communication
  - Status Indicators
  - Fiber Cable and LC Connector
  - Configure Stratix Switches
- 

## ENET-UM001I-EN-P, January 2010

---

### Change

Description of 1783-ETAP1F and 1783-ETAP2F EtherNet/IP Fiber Taps to the EtherNet/IP Overview chapter

Updated Rockwell Automation Products with Embedded Switch Technology section

1783-ETAP, 1783-ETAP1F, and 1783-ETAP2F EtherNet/IP Tap Status Indicators

---

## ENET-UM001H-EN-P, September 2009

---

### Change

Added new products added to the EtherNet/IP Overview chapter

Configure a Supervisor on a Device Level Ring Network

Added 1783-ETAP EtherNet/IP Tap Status Indicators

Added 1734-AENT and 1734-AENTR EtherNet/IP POINT I/O Adapter Status Indicators

Added 1738-AENTR ArmorPOINT® I/O 2-port EtherNet/IP Adapter Status Indicators

---

## ENET-UM001G-EN-P, November 2008

---

### Change

---

Added New modules, including 1756-EN2F, 1769-L23E-QBx packaged controllers

---

Added Safety I/O in EtherNet/IP Control Systems

---

Added Configure Stratix Switches

---

Added Set the Requested Packet Interval (RPI)

---

Added Troubleshoot an EtherNet/IP Module

---

Added Fiber Cable and LC Connector

---

Added Interpret the Status Indicators

---

Added 1756-EN2F EtherNet/IP Module Status Indicators

---

Added 1769-L23E-QB1B, 1769-L23E-QBFC1B Controllers Status Indicators

---

## ENET-UM001F-EN-P, November 2006

---

### Change

---

Added about the 1756-EN2T Module

---

Added about the 1734-AENT Module

---

Added about the 20-COMM-E Module

---

Added about the 22-COMM-E Module

---

Added Set the IP Network Address

---

Added USB Port Connection

---

Added 1734-AENT EtherNet/IP POINT I/O Adapter Status Indicators

---

## ENET-UM001E-EN-P, January 2006

---

### Change

---

Added 1768-ENBT Overview

---

Added Module LED Indicators

---

Added EtherNet/IP Network Connections

---

## ENET-UM001D-EN-P, July 2005

---

### Change

---

Added 1769-L35E controllers using firmware revision 15.01 support duplicate IP address detection

---

Added 1769-L32E and 1769-L35E LED indicators

---

## ENET-UM001C-EN-P, October 2004

---

### Change

---

The following modules support email capability:

- 1756-ENBT, firmware revision 3.3
  - 1788-ENBT, firmware revision 2.1
  - 1769-L32E and 1769-L35E, all firmware revisions
-

## ENET-UM001B-EN-P, June 2004

---

### Change

---

Added description of the new duplicate IP address detection feature. The following EtherNet/IP modules support duplicate IP address detection:

- 1756-ENBT, firmware revision 3.2
  - 1788-ENBT, firmware revision 2.1
- 

Added information on IP address swapping

---

Additional information on using DNS addressing

---

Additional information regarding communication formats

---

Updated web-based diagnostic pages

---

Corrections to module certifications

---

**A**

- access distributed I/O modules** 44, 45
- add distributed I/O modules**
  - overview 34, 36
  - selecting a remote adapter 42
  - with Studio 5000 environment 45

**B**

- BOOTP/DHCP server**
  - setting IP network address 20-22

**C**

- communication driver** 14-15
- communication format** 37, 42
  - direct connections 39
  - ownership 41, 42
  - rack-optimized connections 40
- configure**
  - DHCP server 22
  - EtherNet/IP modules 17-30
  - MSG instructions 78
  - personal computer 13-15
  - RSLinx software 24-25
  - Studio 5000 environment 26
- connections**
  - data transfer 59
  - I/O 37
  - interlocking 50
  - messaging 59
  - produced and consumed tags 50
  - to PanelView terminals 84
  - to RSVIEW applications 89
- consume tags** 49, 53, 57
- control application** 30
- control I/O**
  - adding distributed I/O modules 34, 36
  - communication format 37, 42
  - connections 37
  - hardware 33
  - ownership 41
  - RPI 43
- control system** 11
- controller ownership** 41
- convert between INTs and DINTs** 67

**D**

- data transfer**
  - configuring 63, 66
  - connections 59
  - guidelines 58
  - logic 60
  - mapping tags 68
  - overview 47, 70
  - to PLC-5 or SLC controllers 67
- DHCP server** 22
- diagnostics**
  - Ethernet statistics 100, 103
  - monitor 91
  - overview 93, 95, 96, 97, 98, 101

- direct connection** 37
- DNS addressing** 29-30
- domain name** 18
- download** 30
- driver** 14-15
- duplicate address detection** 27-28

**E**

- electronic keying** 30
- email**
  - MSG instruction 78
  - overview 71
  - send through an EtherNet/IP module 71-81
  - sending via MSG instruction 73-79
  - status codes 80
  - text format 80
- EtherNet/IP modules**
  - configuring 17-30
  - control application 30
  - overview 11
  - set IP network address 18
  - using in control system 11

**G**

- gateway** 17

**H**

- host name** 18

**I**

- I/O**
  - controlling over EtherNet/IP 33
- interlocking**
  - connections 50
  - consume tags 53, 57
  - organize tags 49
  - overview 47, 70
  - produce tags 51, 52
  - terminology 49
- IP addresses**
  - definition 17
  - DHCP server 22
  - duplicate address detection 27-28
  - RSLinx software 24-25
  - set 18
  - Studio 5000 environment 26
  - swapping in redundant systems 28

**K**

- keying, electronic** 30

**M**

- map tags** 68

**messaging**

- configuring 63, 66
- connections 59
- guidelines 58
- logic 60
  - data transfer 62
- mapping tags 68
- overview 47, 70
- to PLC-5 or SLC controller 67

**MSG instruction**

- configuring 63, 66
- connections 59
- guidelines 58
- logic 60, 62
- mapping tags 68
- sending email 78
- sending via an email 73-79
- to PLC-5 or SLC controllers 67

**N****network address**

- DNS addressing 29-30
- set IP network address 18

**network overview**

- modules in an EtherNet/IP control system 11

**network parameters**

- DNS addressing 18
- domain name 18
- gateway 17
- host name 18
- IP addresses 17
- subnet mask 17

**O****ownership 41**

- listen-only connection 41
- owner controller 41

**P****PanelView terminals**

- adding in Studio 5000 environment 85-88
- communicating with Logix5000 controller
  - over an EtherNet/IP network 83-89
- determining connections 84
- organizing controller data 89
- set up hardware 83

**personal computers**

- placing on network 13-15

**PLC-5 controller 67****produce tags 49, 51, 52****produced and consumed tags**

- connections 50
- consume tags 53, 57
- organize tags 49
- overview 47, 70
- produce tags 51, 52
- set up hardware 48
- terminology 49

**R****rack-optimized connection 37****remote adapter 42****requested packet interval 43, 44****RPI 43****RSLink software**

- communication driver 14-15
- configuring network parameters 24-25
- setting IP network address 18

**S****select a remote adapter 42****set IP network address 18**

- BOOTP/DHCP server 20-22
- RSLink software or RSLogix 5000 software 18
- thumbwheel switch 18

**set the requested packet interval**

- with Studio 5000 environment 43, 44

**set up hardware**

- data transfer 48
- I/O modules over EtherNet/IP 33
- interlocking 48
- messaging 48
- PanelView terminals and Logix5000 controllers 83
- produced and consumed tags 48

**set up I/O**

- controlling I/O 33

**SLC controller 67****status codes**

- email 80

**string tags 73****Studio 5000 environment**

- adding a PanelView terminal 85-88
- adding distributed I/O modules 34, 45
- consume a tag 53, 57
- produce a tag 51, 52
- set the requested packet interval 43, 44
- setting IP network address 18
- software
  - adding distributed I/O modules 36

**subnet mask 17****swap IP addresses 28****T****thumbwheel switch**

- set IP network address 18

**troubleshoot**

- web browser support 92

**W****web browser support 92**





## Rockwell Automation Support

Rockwell Automation provides technical information on the Web to assist you in using its products.

At <http://www.rockwellautomation.com/support> you can find technical and application notes, sample code, and links to software service packs. You can also visit our Support Center at <https://rockwellautomation.custhelp.com/> for software updates, support chats and forums, technical information, FAQs, and to sign up for product notification updates.

In addition, we offer multiple support programs for installation, configuration, and troubleshooting. For more information, contact your local distributor or Rockwell Automation representative, or visit <http://www.rockwellautomation.com/services/online-phone>.

## Installation Assistance

If you experience a problem within the first 24 hours of installation, review the information that is contained in this manual. You can contact Customer Support for initial help in getting your product up and running.

United States or Canada	1.440.646.3434
Outside United States or Canada	Use the <a href="#">Worldwide Locator</a> at <a href="http://www.rockwellautomation.com/rockwellautomation/support/overview.page">http://www.rockwellautomation.com/rockwellautomation/support/overview.page</a> , or contact your local Rockwell Automation representative.

## New Product Satisfaction Return

Rockwell Automation tests all of its products to help ensure that they are fully operational when shipped from the manufacturing facility. However, if your product is not functioning and needs to be returned, follow these procedures.

United States	Contact your distributor. You must provide a Customer Support case number (call the phone number above to obtain one) to your distributor to complete the return process.
Outside United States	Please contact your local Rockwell Automation representative for the return procedure.

## Documentation Feedback

Your comments will help us serve your documentation needs better. If you have any suggestions on how to improve this document, complete this form, publication [RA-DU002](#), available at <http://www.rockwellautomation.com/literature/>.

Rockwell Automation maintains current product environmental information on its website at <http://www.rockwellautomation.com/rockwellautomation/about-us/sustainability-ethics/product-environmental-compliance.page>.

Rockwell Otomasyon Ticaret A.Ş., Kar Plaza İş Merkezi E Blok Kat:6 34752 İçerenköy, İstanbul, Tel: +90 (216) 5698400

**[www.rockwellautomation.com](http://www.rockwellautomation.com)**

### Power, Control and Information Solutions Headquarters

Americas: Rockwell Automation, 1201 South Second Street, Milwaukee, WI 53204-2496 USA, Tel: (1) 414.382.2000, Fax: (1) 414.382.4444  
Europe/Middle East/Africa: Rockwell Automation NV, Pegasus Park, De Kleetlaan 12a, 1831 Diegem, Belgium, Tel: (32) 2 663 0600, Fax: (32) 2 663 0640  
Asia Pacific: Rockwell Automation, Level 14, Core F, Cyberport 3, 100 Cyberport Road, Hong Kong, Tel: (852) 2887 4788, Fax: (852) 2508 1846

Publication ENET-UM001N-EN-P - July 2015

Supersedes Publication ENET-UM001M-EN-P - November 2014

Copyright © 2015 Rockwell Automation, Inc. All rights reserved. Printed in the U.S.A.