

# Presence Sensing

Maximum Flexibility, Reliability and Performance

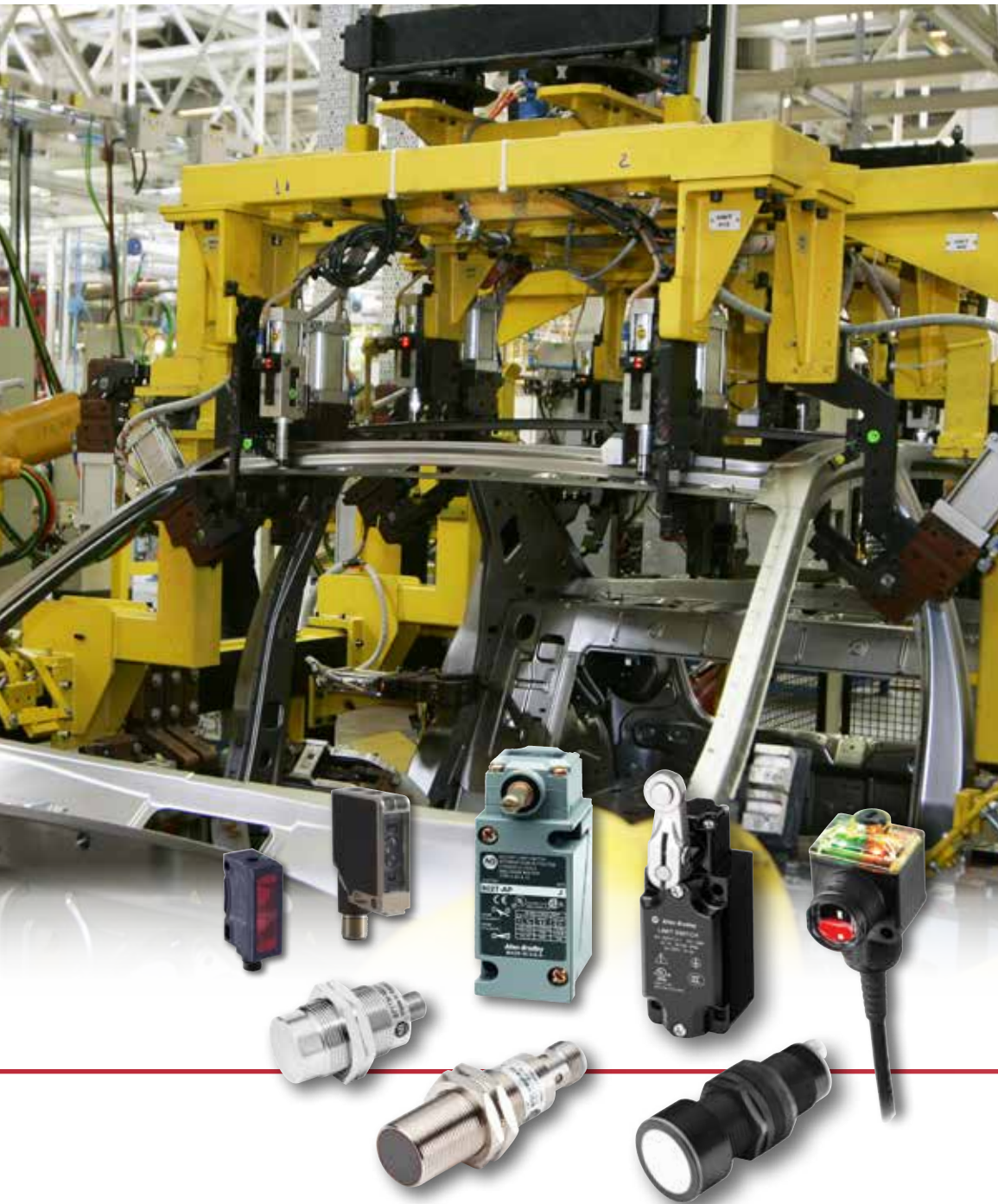

LISTEN.  
THINK.  
SOLVE.®



# Choose from one of the industry's broadest sensor portfolios

Rockwell Automation offers quality Allen-Bradley® components with over 110 years of time-tested reliability and durability. And when it comes to sensors, we have one of the broadest lines in the industry including Allen-Bradley limit switches, proximity, photoelectric, capacitive and ultrasonic sensors. Allen-Bradley sensors and switches set the standard for ruggedness, dependability and application flexibility.

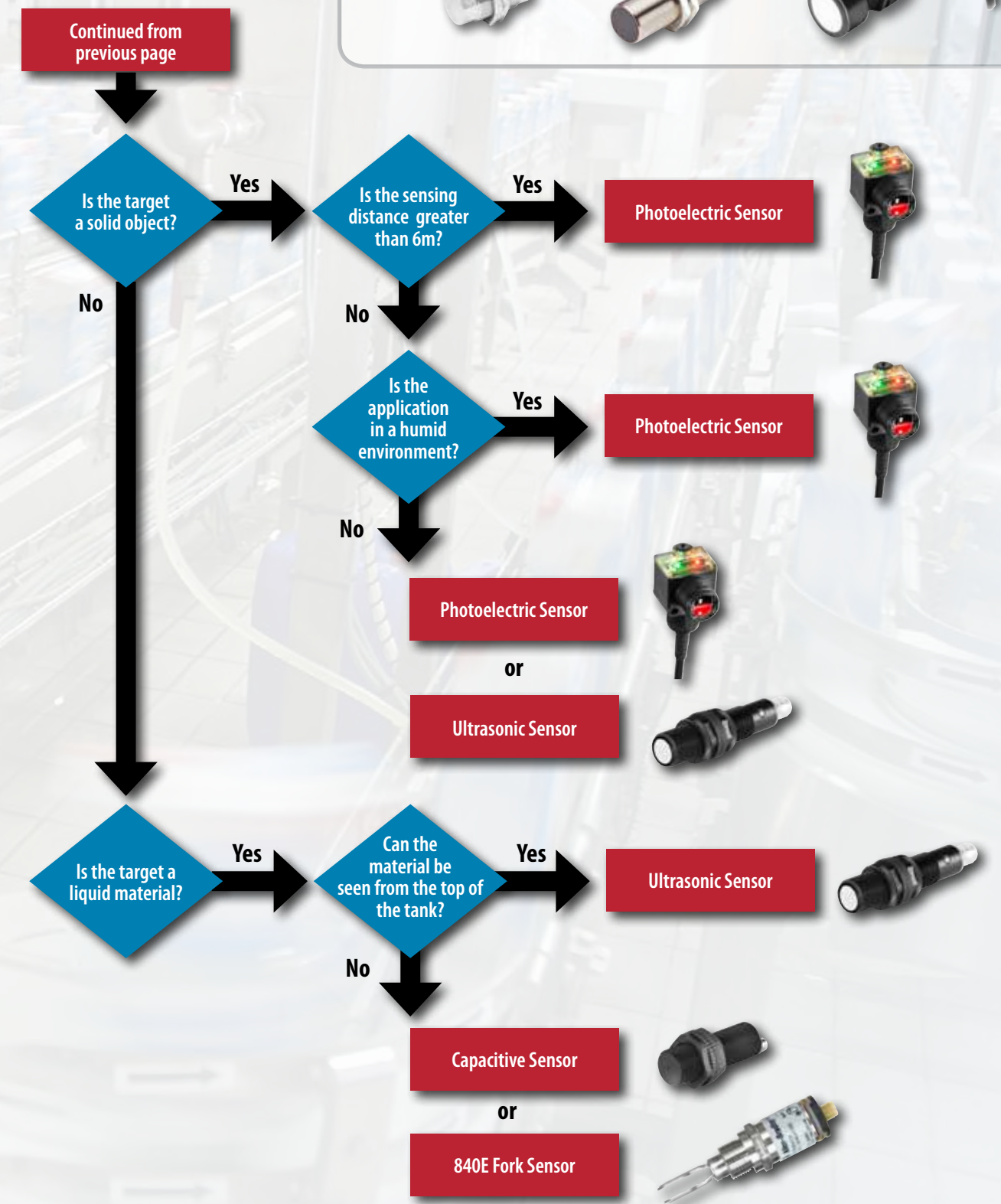
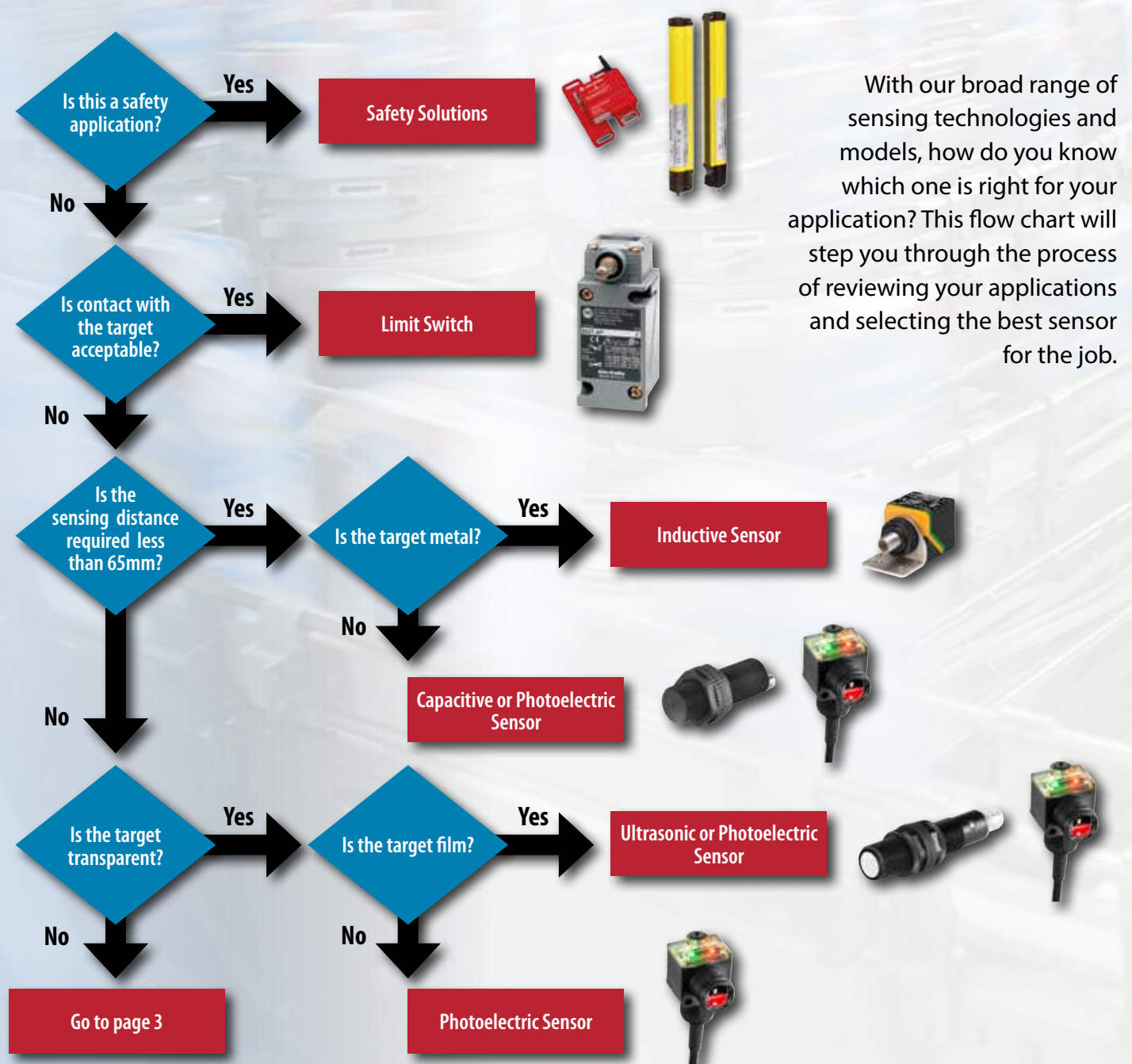



# Solutions for your toughest applications

Designed for reliable operation, Allen-Bradley sensors boast features and functions aimed to satisfy applications found in many industries such as material handling, packaging, food processing and transportation. Whether your application requires a general purpose sensor, a full-featured model or a specialty solution, there's an Allen-Bradley sensor to suit your needs.

## Photoelectric Sensors



*Bottle detection - The 42JT clear object sensor reliably detects clear bottles thanks to specialized optics.*

Nobody offers a more comprehensive line of photoelectric sensors than Rockwell Automation.

- General purpose and heavy duty models
- Background suppression
- Laser sensors
- Color registration
- Clear object detection
- Fork, label and luminescence sensors
- Fiber optics
- Light arrays

## Inductive Sensors

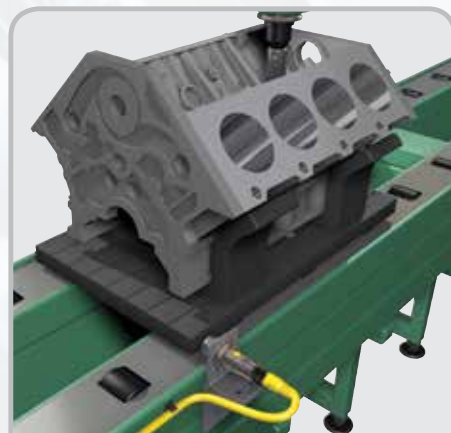

*Automotive application - An 871TM detecting presence of an engine block skid*

From miniature models to harsh duty stainless steel models, we offer one of the largest proximity sensor portfolios in the industry.

- General purpose and harsh duty
- Tubular
- Rectangular & cube
- Miniature
- Weld field immune
- Cylinder position
- Ring & slot

## Capacitive Sensors



*Pellet level detection - An 875CP detects the level of plastic pellets through a glass vessel*

Our capacitive models detect metals as well as non-metal solids, making them an ideal choice in applications where other technologies simply won't work.

- Tubular
- Metal and plastic models
- Adjustable sensing distance

## Limit Switches

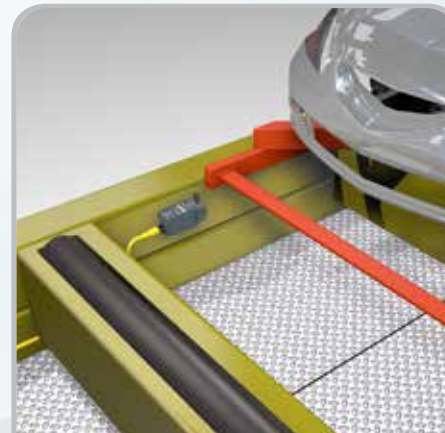

*Automotive application - An 802T limit switch detecting skid position in a body shop*

In applications where contact with the target is acceptable, our limit switches offer rugged, reliable detection in a simple, cost-effective solution.

- NEMA and IEC styles
- Heavy duty and submersible switches
- Safety models
- Hazardous location versions

## Ultrasonic Sensors



*Film position detection - An 873M ultrasonic checks for continual feed of a clear wrap while monitoring tension*

For many applications, such as web tension monitoring, our ultrasonic sensors can tackle jobs that would be challenging for other technologies.

- Detect solid or liquid targets
- Clear object detection
- Analog or discrete outputs
- Programmable

## What is IO-Link ?

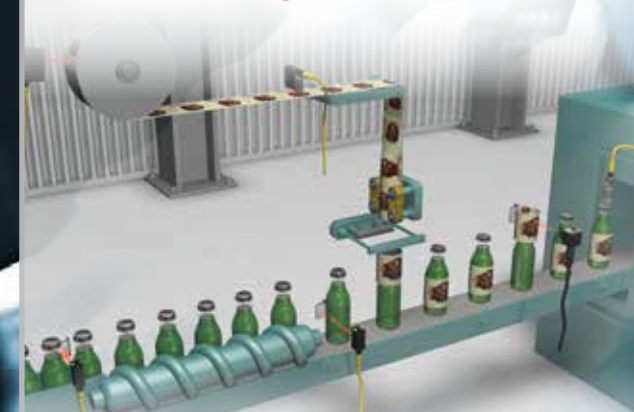

When it comes to linking end point devices on the plant floor to The Connected Enterprise, Rockwell Automation offers a wide range of smart IO-Link enabled sensors that deliver information, advanced functionality and flexibility. All this while increasing efficiency machine- and plant-wide. Through IO-Link you can access all sensor configuration parameters, process data and diagnostics while monitoring your machine's health as it runs. Plus, IO-Link simplifies setup and commissioning while offering enhanced flexibility for your current - and future - processes.



Look for this symbol for IO-Link enabled sensors

Pages 6-9



Pages 10-11



Pages 10-11



Pages 12-13



Page 14



Additional products  
Page 15





# Photoelectric Sensors

Allen-Bradley photoelectric sensors are recognized as the most robust in the industrial automation marketplace. From general purpose models to laser sensing solutions and specialty models that address your most challenging applications.

## For your selection keep in mind...



**Margin:** defined as the measurement of the amount of light from the light source detected by the receiver, expressed as a multiple of the minimum amount of light level required to switch the sensor output. A margin of 2X is reached when the light level received is twice the minimum required to switch the output.

For minimizing maintenance the sensor should be operated at a margin greater than 2X. Detection in dirty environments (or of a low reflectivity target) requires sensors with higher margin.

**Light Operate Output (LO):** output is ON (energized) when the receiver can see sufficient light from the light source.









**Dark Operate Output (DO):** output is ON (energized) when the receiver cannot see light from the light source.

Application Considerations			
Target	Environmental	Electrical	Installation
Detection Range	Temperature	Supply Voltage	Mounting Space
Object	• High	• DC or AC	Cable Connections
• Shape	• Low	Output Type	• 2 m cable
• Size	Conditions	• PNP, NPN	• Micro M12 QD
• Opacity	• Wet or dry	• SPDT relay,	• Pico M8 QD
• Reflectivity	• Clean or dirty	MOSFET	Shock/Vibration
• Speed	• Humidity	Response Time	Interference
	Chemical Substances	Analog Outputs	• Electrical Noise
	High Pressure Washdown	Communications	• Sunlight

Standard Sensing Modes	Advantages	Precautions
<b>Diffuse</b> 	<ul style="list-style-type: none"> <li>Ideal for short range applications</li> <li>No reflector required</li> <li>Easy installation/alignment</li> </ul>	<ul style="list-style-type: none"> <li>Sensing range depends on target's characteristics (color, reflectivity, etc.)</li> <li>Highly reflective backgrounds may false trigger the sensor</li> <li>Relatively short sensing distance</li> </ul>
<b>Retroreflective</b> 	<ul style="list-style-type: none"> <li>Moderate sensing distances</li> <li>Easy to align</li> <li>Requires mounting and wiring of only one emitter/receiver unit</li> </ul>	<ul style="list-style-type: none"> <li>Shorter sensing distances than transmitted beam</li> <li>May detect reflections from shiny objects (see polarized retroreflective)</li> <li>Reflector required</li> </ul>
<b>Transmitted Beam</b> 	<ul style="list-style-type: none"> <li>High margin for contaminated environments</li> <li>Longer sensing ranges than other technologies</li> <li>Most reliable sensing mode for highly reflective objects</li> </ul>	<ul style="list-style-type: none"> <li>Requires proper alignment</li> <li>Not recommended for clear object sensing</li> <li>Space required to mount and wire separate emitter and receiver</li> </ul>

Specialty Sensing Modes					
Polarized Retroreflective	Sharp Cutoff Diffuse	Background Suppression Diffuse	Wide Angle Diffuse	Fixed Focus Diffuse	Fiber Optics
<ul style="list-style-type: none"> <li>Polarized light to overcome first surface reflections from shiny objects</li> <li>Visible red LED simplifies sensor alignment</li> </ul>	<ul style="list-style-type: none"> <li>Diffuse sensing that provides some degree of protection against sensing close backgrounds</li> <li>Offers longer range than background suppression sensors</li> </ul>	<ul style="list-style-type: none"> <li>Ignores backgrounds beyond rated sensing distance regardless of reflectivity</li> <li>Designed to detect objects regardless of color at the specified distance</li> </ul>	<ul style="list-style-type: none"> <li>Ideal for detection of objects not accurately positioned, thread or for detection over a broad area</li> <li>Good at ignoring background reflections</li> </ul>	<ul style="list-style-type: none"> <li>Accurate detection of small objects at the sensor's specified distance</li> <li>Color mark detection for high contrast applications</li> </ul>	<ul style="list-style-type: none"> <li>Allows sensing of very small parts</li> <li>Fiber cables can be installed in very tight spaces</li> <li>Glass fibers for high temperature applications up to 482°C (899°F)</li> <li>Plastic fibers can be used for continuous flexing applications</li> <li>Shock, noise and vibration resistant</li> </ul>





# General Purpose Solutions

Product	Product Features	Sensing Range												
		100 mm	200 mm	400 mm	600 mm	800 mm	1 m	2 m	4 m	6 m	8 m	10 m	20 m	> 30 m
<b>42JS VisiSight™</b> 	<ul style="list-style-type: none"> <li>Industry standard small rectangular (20 mm L x 14 mm W x 33 mm H) enclosure</li> <li>Visible red LED on all models for ease of alignment</li> <li>Complementary LO and DO</li> <li>IP67 enclosure</li> </ul>													
<b>42JT VisiSight</b> 	<ul style="list-style-type: none"> <li>Industry standard small rectangular (20 mm L x 12 mm W x 34 mm H) enclosure</li> <li>Push button teach for easy set up</li> <li>Visible red LED or Laser (Class 1) on all models for ease of alignment</li> <li>Auto Detection continuously monitors and configures the output automatically to PNP or NPN</li> <li>LO or DO configurable on every model</li> <li>IP69K enclosure rating suitable for harsh duty environments</li> </ul>													
<b>Series 9000™</b> 	<ul style="list-style-type: none"> <li>Universal 30 mm base and thru-hole mounting</li> <li>High-pressure washdown (IP69K and 1200 PSI) enclosure</li> <li>Standard ON/OFF, timing and diagnostics output models</li> <li>Dual (PNP and NPN) with LO or DO selection</li> <li>DC and AC/DC relay output</li> </ul>													
<b>RightSight™</b> 	<ul style="list-style-type: none"> <li>Universal 18 mm base, nose and thru-hole mounting</li> <li>High-pressure washdown (IP69K and 1200 PSI) enclosure</li> <li>Fixed, teachable and adjustable sensitivity</li> <li>Dual (PNP and NPN) outputs or complementary (LO and DO) models</li> <li>DC and AC/DC solid state outputs</li> </ul>													
<b>42KD</b> 	<ul style="list-style-type: none"> <li>Our smallest rectangular photoelectric sensor</li> <li>Ranges up to 3 m</li> <li>IP67 enclosure rating</li> <li>Auto PNP/NPN</li> <li>Push button teach</li> <li>Through-hole or dovetail clamp mounting</li> <li>Visible red</li> </ul>													
<b>MiniSight™</b> 	<ul style="list-style-type: none"> <li>Compact rectangular size with 18 mm nose and thru-hole mounting</li> <li>High-pressure washdown (1200 PSI) enclosure</li> <li>Fast response time (300 μs) models</li> <li>Selectable LO and DO</li> <li>DC and AC/DC solid state outputs</li> </ul>													
<b>42CA</b> 	<ul style="list-style-type: none"> <li>Industry standard 18 mm enclosure</li> <li>Plastic housing suitable for corrosive environments</li> <li>Complementary LO and DO</li> <li>Fast response time (0.5 ms) models</li> <li>IP67 enclosure</li> </ul>													
<b>42CS</b> 	<ul style="list-style-type: none"> <li>Robust 316L housing material</li> <li>Smooth barrel version minimizes build up and allows for easy clean up (also available in threaded version)</li> <li>IP69K enclosure rating and ECOLAB certification make this ideal for harsh duty environments</li> <li>Industry standard 18 mm barrel diameter</li> <li>Extended temperature operating range</li> <li>Ferromagnetic teach provides adjustability without compromising integrity</li> <li>Two teach modes: standard and precision</li> </ul>													
<b>42CM</b> 	<ul style="list-style-type: none"> <li>Industry standard 18 mm enclosure</li> <li>Metal housing suitable for heavy duty environments</li> <li>Complementary LO and DO</li> <li>IP67 enclosure</li> </ul>													

General Purpose Sensors



# Laser Sensors



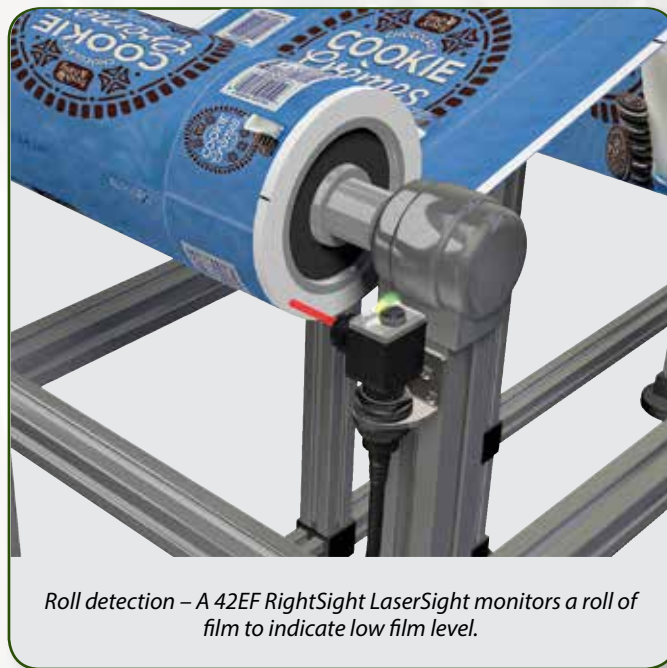

Product	Product Features
 <b>42JT VisiSight</b>	<ul style="list-style-type: none"> <li>Industry standard small rectangular (20 mm L x 12 mm W x 34 mm H) enclosure</li> <li>Available in diffuse (250 mm), polarized retroreflective (15 m), transmitted beam (18 m), and adjustable background suppression (120 mm)</li> <li>Auto Detection continuously monitors and configures the output automatically to PNP or NPN</li> <li>Class 1 laser</li> <li>IP69K enclosure rating suitable for harsh duty environments</li> </ul>
 <b>LaserSight™ RightSight</b>	<ul style="list-style-type: none"> <li>Universal 18 mm base, nose and thru-hole mounting</li> <li>Small parts detection in light duty environments</li> <li>Available in diffuse (300 mm), polarized retroreflective (15 m) and transmitted beam (40 m)</li> <li>Dual PNP and NPN outputs</li> <li>IP54 enclosure</li> </ul>
 <b>LaserSight 42CM</b>	<ul style="list-style-type: none"> <li>Industry standard 18 mm metal enclosure</li> <li>Metal housing suitable for heavy duty environments</li> <li>Available in diffuse (300 mm), polarized retroreflective (30 m) and transmitted beam (50 m)</li> <li>Small spot size beam (0.1 mm @ 100 mm) on diffuse for small object or contrast detection</li> <li>Complementary LO and DO</li> <li>IP67 enclosure</li> </ul>
 <b>LaserSight 9000</b>	<ul style="list-style-type: none"> <li>Universal 30 mm base and thru-hole mounting</li> <li>High pressure washdown (IP69K and 1200 PSI)</li> <li>For long sensing range applications (polarized retroreflective 40 m, transmitted beam 300 m)</li> <li>Dual (PNP and NPN) with LO or DO selection</li> <li>DC and AC/DC relay output enclosure</li> </ul>

 I/O-Link Enabled







Product	Product Features
 <b>45LMS</b>	<ul style="list-style-type: none"> <li>Diffuse range: 8 m (Class 1 laser), 15 m (Class 2 laser)</li> <li>Retroreflective model range: 50 m</li> <li>Discrete and analog outputs</li> <li>IP65 enclosure</li> </ul>
 <b>45BPD/45BRD</b>	<ul style="list-style-type: none"> <li>Class 2 visible laser</li> <li>IP67 enclosure</li> <li>45BPD                             <ul style="list-style-type: none"> <li>300 mm or 100 mm sensing range</li> <li>One analog (4-20 mA) and one discrete output</li> <li>Laser disable input</li> <li>Teach button lock</li> </ul> </li> <li>45BRD                             <ul style="list-style-type: none"> <li>45-85 mm sensing range</li> <li>One analog (0-10V) output</li> </ul> </li> </ul>



# Specialty Solutions

Product	Product Features
 <b>42JT VisiSight™</b>	<ul style="list-style-type: none"> <li>120 mm sensing range</li> <li>Auto detection continuously monitors and configures the output automatically to PNP or NPN</li> <li>Fast response time (500 μs)</li> <li>Selectable LO and DO</li> <li>IP69K enclosure rating suitable for harsh duty environments</li> </ul>
 <b>42BA</b>	<ul style="list-style-type: none"> <li>Wide variety of sensing range models (30 mm, 50 mm, 100 mm, 200 mm)</li> <li>Diagnostic output</li> <li>Selectable LO and DO</li> <li>Fast response time (350 μs)</li> <li>Compact NEMA 4, 6P, IP67 enclosure</li> </ul>
 <b>42BT</b>	<ul style="list-style-type: none"> <li>Long range background suppression (1 m and 2 m models)</li> <li>Slim flatpack housing design</li> <li>Infrared LED or Red LED depending on range</li> <li>Selectable LO and DO</li> <li>Dual (PNP and NPN) outputs</li> <li>2 ms response time</li> <li>IP65 enclosure</li> </ul>
 <b>42CS</b>	<ul style="list-style-type: none"> <li>Robust 316L housing material</li> <li>Smooth barrel version minimizes build up and allows for easy clean up (also available in threaded version)</li> <li>Available in diffuse (800 mm), polarized retroreflective (4 m), transmitted beam (20 m), clear object detection (1 m), and adjustable background suppression (100 mm)</li> <li>IP69K enclosure rating and ECOLAB certification make this ideal for harsh duty environments</li> <li>Industry standard 18 mm barrel diameter</li> <li>Extended temperature operating range</li> <li>Ferromagnetic teach provides adjustability without compromising integrity</li> <li>Two teach modes: standard and precision</li> </ul>
 <b>45CRM</b>	<ul style="list-style-type: none"> <li>Diffuse mode sensor for recording any print mark</li> <li>Teach-in, static and dynamic</li> <li>50 μs response time, suitable for extremely rapid scanning processes</li> <li>Sensing range: 11 mm ± 2 mm</li> <li>0.7 mm (effective light spot diameter)</li> <li>Complementary LO and DO</li> </ul>
 <b>ColorSight™ 45CLR</b>	<ul style="list-style-type: none"> <li>Wide sensing range tolerance</li> <li>Three-channel color matching (3 outputs)</li> <li>12-32 mm sensing range</li> <li>RS-485 models can internally match up to five color configurations and communicate true RGB values</li> <li>IP67 enclosure</li> </ul>
 <b>42JT VisiSight™ Color Mark</b>	<ul style="list-style-type: none"> <li>12 mm sensing range with +/- 2.5 mm tolerance</li> <li>1 x 4 mm spot size at 12 mm</li> <li>White LED light source allows for the detection of a wide range of color marks with different color backgrounds</li> <li>Light source provides visual feedback indicating teach settings</li> <li>Push-pull output (PNP or NPN)</li> <li>Fast 50 μs response time</li> <li>Remote teach and lock input</li> <li>IP67, IP69K enclosure</li> </ul>

 I/O-Link Enabled

Product	Product Features
 <b>42JT VisiSight Clear Object</b>	<ul style="list-style-type: none"> <li>2 m sensing range with 92-118 reflector</li> <li>Coaxial optics for superior clear object detection</li> <li>Auto PNP and NPN helps streamline inventory</li> <li>IP69K enclosure</li> </ul>
 <b>ClearSight™ RightSight</b>	<ul style="list-style-type: none"> <li>General purpose plastic film and stretch-wrap detection solution</li> <li>1 m sensing range</li> <li>DC and AC/DC models available</li> <li>1 ms response time</li> <li>NEMA 3, 4X, 6P, 12, 13, IP69K and 1200 psi enclosure</li> </ul>
 <b>45FPL</b>	<ul style="list-style-type: none"> <li>General purpose contrast sensing</li> <li>Twice the sensing range of DIN rail fiber portfolio</li> <li>Large status indicator displays</li> <li>One touch multi-directional push buttons</li> <li>Status indicator displays light levels, operating modes and diagnostic information</li> <li>Two-step static teach or dynamic teach functionality</li> <li>Two programmable sensing modes: long range (1.8 ms) and high speed (190 μs)</li> <li>Threshold value and current value display</li> </ul>
 <b>45FVL/45FSL</b>	<ul style="list-style-type: none"> <li>General purpose contrast sensing</li> <li>Visible red, blue, green or white light source</li> <li>Automatic or manual sensitivity adjustment (45FVL)</li> <li>30 μs response time (45FSL)</li> <li>IP40 enclosure</li> </ul>
 <b>RightSight™</b>	<ul style="list-style-type: none"> <li>General purpose long range fiber optic applications (up to 1.5 meters)</li> <li>Individual fiber cables for transmitted beam and bifurcated cable for diffuse applications</li> <li>Large aperture 4.6 mm glass fiber optic cable makes it an ideal solution for high temperature environment</li> <li>DC and AC/DC models</li> </ul>
 <b>45LSP</b>	<ul style="list-style-type: none"> <li>30, 50, 80, 120 mm gap sizes</li> <li>Detection of objects as small as 0.2 mm</li> <li>Highly visible power and output LED indicators with output indication along both sides of the fork</li> <li>Selectable LO and DO</li> <li>3 pin and 4 pin pico (M8) QD models</li> <li>250 μs response time</li> <li>IP67 polycarbonate enclosure</li> </ul>
 <b>45LST</b>	<ul style="list-style-type: none"> <li>2, 15, 30, 50, 80, 120, 225 mm gap sizes</li> <li>Rugged industrial aluminum housing</li> <li>Selectable LO or DO outputs</li> <li>1 ms response time (30 μs on 2 mm gap model)</li> <li>IP65 enclosure</li> </ul>











# Proximity Sensors

Allen-Bradley proximity sensors set the standard for toughness and versatility. Choose from one of the industry's widest selections of proximity sensor models. This diverse offering serves the full spectrum of your needs, from light-duty packaging applications to the grueling environments on automotive welding equipment or the harsh washdowns in food processing plants.

Inductive proximity sensors provide non-contact detection of metal objects across relatively short distances (up to 2.5 inches or 65 mm). Capacitive models can detect non-metal solids and liquids in addition to standard metal targets. They can even sense the presence of some targets through certain other materials, making them an ideal choice in those applications where other technologies cannot be used.

	Product	Product Features	Housing Diameter/Dimensions (mm)	Sensing Range Shielded (mm)	Sensing Range Unshielded (mm)	Enclosure Ratings	2-wire DC	3-wire DC	4-wire DC	2-wire AC	2-wire AC/DC
General Purpose		<ul style="list-style-type: none"> <li>Nickel-plated brass barrel with plastic face</li> <li>Standard length and short barrel versions (3-wire DC versions)</li> <li>Extended and long range versions available (3-wire DC and 2-wire AC)</li> <li>Wide variety of cable and connector options</li> </ul>	6.5	2 & 3	3	IP67	✓	✓	✓	✓	✓
			8	2 & 3	3, 4, 6						
			12	3, 4, 6	4, 8, 10						
			18	5, 8, 12	8, 12, 20						
Harsh Duty		<ul style="list-style-type: none"> <li>Plastic or nickel-plated brass housings</li> <li>AC or DC models available</li> <li>Available in cable, micro QD or pico QD</li> <li>Threaded or smooth barrels in plastic versions</li> </ul>	12	2.5 (metal)	n/a	IP67		✓		✓	
			18	1...5 (metal)	2...8 (plastic)						
			30	2...10 (metal)	5...20 (plastic)						
			34	n/a	7...30 (plastic)						
Food & Beverage		<ul style="list-style-type: none"> <li>Rugged stainless steel 304 barrel and sensing face</li> <li>Extended Range units available (3-wire DC versions)</li> <li>Wide variety of sensing types available (standard inductive, weld-field immune, low energy AC/DC units, and intrinsically safe versions)</li> </ul>	8	3	6	All units IP67 & 1200 psi wash down rated (Selected units meet IP69K)	✓	✓		✓	✓
			12	2 & 6	4 & 10						
			18	5 & 10	8 & 20						
			30	10 & 20	15 & 40						
Food & Beverage		<ul style="list-style-type: none"> <li>Stainless steel 316L barrel and FDA approved PPS plastic sensing face</li> <li>ECOLAB certified</li> <li>Extended temperature ratings -40° to 100°C (-40° to 212°F)</li> <li>Laser engraved part numbers</li> <li>Threaded or smooth barrel</li> </ul>	12	4	8	IP67, IP68 & IP69K			✓		
			18	8	12						

	Product	Product Features	Product	Product Features
Specialty Solutions		<ul style="list-style-type: none"> <li>Designed for use in power clamp and gripper applications to indicate open and closed position</li> <li>Weld field immune</li> <li>2 different sensor head styles</li> <li>3-wire DC and 2-wire AC/DC versions</li> </ul>		<ul style="list-style-type: none"> <li>Designed to detect the extended or retracted position of a hydraulic or pneumatic cylinder</li> <li>Weld field immune</li> <li>Multiple probe lengths to accommodate different size cylinders</li> <li>3-wire DC and 2-wire AC/DC versions</li> </ul>





	Product	Product Features	Housing Diameter/Dimensions (mm)	Sensing Range Shielded (mm)	Sensing Range Unshielded (mm)	Enclosure Ratings	2-wire DC	3-wire DC	4-wire DC	2-wire AC	2-wire AC/DC
Welding		<ul style="list-style-type: none"> <li>Weld field immune</li> <li>PTFE coated brass housing</li> <li>Cable versions available with SOOW cable for excellent weld splatter protection</li> </ul>	12	2	4	IP67		✓			✓
			18	5	8						
			30	10	15						
Welding		<ul style="list-style-type: none"> <li>Weld field immune</li> <li>PTFE coated brass housing</li> <li>Equal sensing (detects all metals at the same sensing distance)</li> <li>Unshielded versions offer extended range</li> </ul>	12	3	8	IP67		✓			
			18	5	12						
			30	10	20						
Material Handling & Welding		<ul style="list-style-type: none"> <li>Head can be rotated in 5 different sensing positions</li> <li>Standard sensing and weld field immune versions</li> <li>Optional Toughcoat™ slag resistant coating available on specific models</li> </ul>	40x40	20	40	All units IP67 & 1200 psi wash down rated (Selected units meet IP69K)			✓		✓
			40x40 WFI	15 & 20	25 & 40						
Material Handling & Welding		<ul style="list-style-type: none"> <li>Large flat pack style sensor for applications that require extremely long sensing range</li> <li>Standard sensing and weld field immune versions</li> </ul>	80x80	50	65	All units IP67 & 1200 psi wash down rated (Selected units meet IP69K)			✓		✓
			80x80 WFI	40	50						
Material Handling & Welding		<ul style="list-style-type: none"> <li>Head can be rotated in 17 different positions</li> <li>Standard NEMA limit switch mounting pattern</li> <li>Switch selectable N.O. or N.C. outputs on 871L</li> <li>Programmable N.O. or N.C. outputs (via jumper) on 872L</li> </ul>	40x40x120	20	40	IP67		✓		✓	✓
Automated Assembly & Robotics		<ul style="list-style-type: none"> <li>Compact housing ideal for small part detection, robotic, and gripper applications</li> <li>Stainless steel barrel and plastic sensing face</li> <li>Fully integrated electronics</li> <li>High switching frequency (≥3 kHz)</li> </ul>	3 smooth barrel	0.6 & 1	NA	IP67		✓			
			4 smooth barrel	0.8 & 1	NA						
			4	0.8 & 1.5	NA						
			5	1 & 1.5	NA						
Automated Assembly & Robotics		<ul style="list-style-type: none"> <li>Compact sensor housings for applications with limited mounting area</li> <li>5x5 and 8x8 solutions offer metal housings while other solutions offer plastic housings</li> <li>AC versions only available in the 28x16x11 and 40x26x12 mm packages</li> </ul>	5x5	0.8 & 1.5	NA	IP67		✓			
			8x8	2	3						
			28x16x11	2	NA						
			25x50x10	5	8						
Hazardous Locations		<ul style="list-style-type: none"> <li>Conform to NAMUR specifications (DIN 19 234)</li> <li>Sensors are appropriate for intrinsically safe applications when used with NAMUR style isolators/amplifiers</li> </ul>	8	1	2	IP67	✓				
			12	2	4						
			18	5	8						
			30	10	15						







	Product	Product Features	Product	Product Features
Specialty Solutions		<ul style="list-style-type: none"> <li>Provide a 0-10V output proportional to the distance from the sensor face</li> <li>Available in 12, 18, and 30 mm housings</li> <li>2 m cable connection</li> </ul>		<ul style="list-style-type: none"> <li>Ring sensors available in 12, 20, 50, and 100 mm diameter sizes</li> <li>Slot sensors available with 30 mm gap</li> <li>All ring and slot sensors 3-wire DC</li> </ul>



# Limit Switches

Rockwell Automation offers one of the most durable lines of limit switches in the industry. Allen-Bradley limit switches are used in a variety of applications and environments because of their ruggedness, simple, visible operation, ease of installation and reliability.

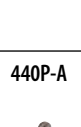
	Product	Product Features	Contact Rating	Temperature Rating	Actuator Types	Enclosure Rating	QD Offered	Status Indicator Offered
Heavy Duty	 <b>801</b>	<ul style="list-style-type: none"> <li>General purpose limit switch for a wide variety of applications</li> <li>Multiple contact arrangements available (Including slow action and snap action)</li> <li>Snap action contacts provide high snap through force</li> </ul>	NEMA A600	0° to 40 °C (32° to 104 °F)	<ul style="list-style-type: none"> <li>Fork lever</li> <li>Roller lever</li> <li>Maintained</li> <li>Rod/chain lever</li> </ul>	NEMA 1, Type 4 or Type 7, and 9		
NEMA General Purpose	 <b>802T Plug-In &amp; Non Plug-In</b>	<ul style="list-style-type: none"> <li>Rugged NEMA Type 4 and 13 oil-tight construction</li> <li>Available in standard non plug-in and plug-in version</li> <li>Plug-in design provides for quick and easy installation</li> <li>2- and 4-circuit versions</li> <li>Simple mode change in head for easy set-up</li> <li>Low energy versions available</li> </ul>	2 Circuit: NEMA A600 4 Circuit: NEMA A300	-18 to 110 °C (0° to 230 °F) Optional -40° to 110 °C (-40° to 230 °F)	<ul style="list-style-type: none"> <li>Low operating force</li> <li>Top and side push (with or without rollers)</li> <li>Cat whisker</li> <li>Wobble stick</li> <li>Neutral position</li> </ul>	NEMA 1, 4, 6P (select side rotary styles), 13	✓	✓
Washdown	 <b>802M/MC</b>	<ul style="list-style-type: none"> <li>Factory sealed to meet the demands of both wet and dry applications</li> <li>Polymeric housing material is highly resistant to moisture as well as volatile cleaning agents</li> <li>802MC corrosion resistant versions are factory sealed and all exposed metal parts are constructed of stainless steel 316</li> <li>Standard units provided with prewired 1.52 m (5 ft) STO cable</li> </ul>	2 Circuit: NEMA A600 4 Circuit: NEMA B300	0° to 80 °C (32° to 180 °F)	<ul style="list-style-type: none"> <li>Lever</li> <li>Maintained</li> <li>Top and side push (with or without rollers)</li> <li>802MC corrosion resistant lever</li> </ul>	NEMA 1, 4, 4X, 6P, 13 and IP67	✓	✓
Light Duty Conveyor	 <b>802G</b>	<ul style="list-style-type: none"> <li>Plug-in gravity return switch, designed for conveyor-type applications with small or lightweight objects</li> <li>Requires low operating torque</li> <li>Adjustable switch point (can be set from 10° to 180° of rotation)</li> <li>Three unique lever arms available</li> </ul>	NEMA B600	0° to 110 °C (32° to 230 °F)	<ul style="list-style-type: none"> <li>Adjustable rod levers (Requires lever arms specifically designed for the 802G product family)</li> </ul>	NEMA 1		✓
Hazardous Locations	 <b>802X, 802XR, 802R</b>	<ul style="list-style-type: none"> <li>NEMA 7 and 9 units appropriate for use in:                             <ul style="list-style-type: none"> <li>Class 1, Groups B, C or D</li> <li>Class II, Groups E, F or G</li> <li>Class III</li> </ul> </li> <li>NEMA 4 watertight versions designed for indoor use</li> <li><b>802XR and 802R</b></li> <li>Sealed limit switch features a single contact hermetically sealed in glass enclosure</li> <li>Offers excellent contact reliability in contaminated atmospheres</li> <li>Appropriate for use in:                             <ul style="list-style-type: none"> <li>Class 1, Div 2, Groups A, B, C, and D</li> </ul> </li> </ul>	<b>802X</b> NEMA A600 NEMA P150 <b>802XR and 802R</b> NEMA B600 NEMA P300	<b>802X</b> -46° to 121 °C (-50° to 250 °F) <b>802XR and 802R</b> -29° to 121 °C (-20° to 250 °F)	<ul style="list-style-type: none"> <li>Lever</li> <li>Top and side push (with or without roller)</li> <li>Wobble stick</li> <li>Maintained (802X only)</li> <li>Neutral position (802X only)</li> <li>Low operating force (802R only)</li> <li>Cat whisker (802R only)</li> </ul>	<b>802X</b> NEMA Types 7 and 9, NEMA 4/ non-hazardous locations, <b>802XR</b> NEMA Types 7 & 9 <b>802R</b> NEMA 13		

	Product	Product Features	Contact Rating	Temperature Rating	Actuator Types	Enclosure Rating	QD Offered	Status Indicator Offered
Compact & Precision	 <b>802B, 802B Precision/ Small Precision</b>	<ul style="list-style-type: none"> <li>Compact metal housing can be mounted in areas too small for traditional NEMA style solutions</li> <li>3 m pre-wired cable</li> <li>13 unique head configurations</li> <li>AC or DC LED versions</li> <li>Low current versions</li> <li>Booted and panel-mount versions</li> </ul> <p><b>Precision/Small Precision</b></p> <ul style="list-style-type: none"> <li>Low trip and reset points for more precise sensing</li> <li>1/2" Conduit entry</li> <li>Side and flange mounting available</li> </ul>	NEMA A300 <b>Precision/ Small Precision</b> NEMA B300	-10° to 70 °C (14° to 158 °F) <b>Precision/ Small Precision</b> -10° to 80 °C (14° to 176 °F)	<ul style="list-style-type: none"> <li>Rotary arm</li> <li>Center rotary arm</li> <li>Top push (with or without rollers)</li> <li>Top push bevel</li> <li>Top push cross roller</li> <li>Wobble stick</li> </ul> <p><b>Precision/Small Precision</b></p> <ul style="list-style-type: none"> <li>Top push roller</li> <li>Top push</li> <li>Top push cross roller</li> <li>Roller lever</li> <li>One-way roller</li> </ul>	NEMA 1, 3, 4, 6, 12, 13 and IP67 <b>Precision</b> NEMA 1, 3, 4, IP60 & IP65 <b>Small Precision</b> NEMA 1, 3, 4, 6, 13 & IP67	<b>802B</b> ✓	<b>802B</b> ✓
IEC Style Solutions/ General Purpose	 <b>802K-M</b>	<ul style="list-style-type: none"> <li>Internationally accepted 30 mm cast aluminum housing for safety and non-safety applications</li> <li>Available with snap-acting, slow make before break or slow break before make contact blocks</li> <li>Large selection of operator heads and actuators</li> </ul>	NEMA A600 NEMA Q600	-25° to 65 °C (-18° to 149 °F)	<ul style="list-style-type: none"> <li>Roller plunger</li> <li>Dome plunger</li> <li>Short lever</li> <li>Adjustable lever</li> <li>Metal spring rod</li> </ul>	IP66		
IEC Style Solutions / Safety Solutions	 <b>440P-M</b>	<ul style="list-style-type: none"> <li>Internationally accepted 30 mm cast aluminum housing for safety and non-safety applications</li> <li>Positive operation, forced disconnection of contacts</li> <li>Available with snap-acting, slow make before break or slow break before make contact blocks</li> <li>Actuator head can be rotated in 90° increments</li> <li>Category 1 device per EN954-1</li> <li>Suitable for Category 3 and 4 systems when ganged together</li> </ul>	NEMA A600 NEMA Q600	-25° to 65 °C (-18° to 149 °F)	<ul style="list-style-type: none"> <li>Roller plunger</li> <li>Dome plunger</li> <li>Short lever</li> <li>Adjustable lever</li> <li>Rod lever</li> <li>Spring rod</li> <li>Telescope arm</li> </ul>	IP66	✓	
	 <b>440P-C</b>	<ul style="list-style-type: none"> <li>Internationally accepted 22 mm plastic housing for safety and non-safety applications</li> <li>Positive operation, forced disconnection of contacts</li> <li>Available with snap-acting, slow make before break or slow break before make contact blocks</li> <li>Actuator head can be rotated in 90° increments</li> <li>Category 1 device per EN954-1</li> <li>Suitable for Category 3 and 4 systems when ganged together</li> </ul>	NEMA A600 NEMA Q600	-25° to 80 °C (-18° to 176 °F)	<ul style="list-style-type: none"> <li>Roller plunger</li> <li>Dome plunger</li> <li>Hinge lever</li> <li>Short lever</li> <li>Offset hinge</li> <li>Adjustable lever</li> <li>Rubber roller</li> </ul>	IP66 IP69K (pre-wired version)	✓	
	 <b>440P-A</b>	<ul style="list-style-type: none"> <li>Internationally accepted compact 22 mm metal housing for safety and non-safety applications</li> <li>Positive operation, forced disconnection of contacts</li> <li>Available with snap-acting, slow make before break or slow break before make contact blocks</li> <li>Pre-wired 2 m cable, bottom or side exit</li> <li>Category 1 device per EN954-1</li> <li>Suitable for Category 3 and 4 systems when ganged together</li> </ul>	NEMA B300 NEMA Q300	2° to 70 °C (36° to 158 °F)	<ul style="list-style-type: none"> <li>Short lever with wide roller</li> <li>Roller plunger</li> <li>Dome plunger</li> <li>Cross roller plunger</li> <li>Short lever</li> </ul>	IP66/IP67		
NEMA Style Safety	 <b>802T Direct Opening</b>	<ul style="list-style-type: none"> <li>Rugged metal housing and plug-in body style utilize the same mounting dimensions as other NEMA style limit switches</li> <li>Direct opening contacts ensure normally closed contacts (safety contacts) open even in the event of a contact weld condition, up to 10 Newtons</li> <li>2-Circuit versions suitable for Category 1 systems per EN954-1</li> <li>4-Circuit versions suitable for Category 3 and 4 systems per EN954-1</li> </ul>	2 Circuit: NEMA A600 4 Circuit: NEMA A300 NEMA Q300	-18° to 110 °C (0° to 230 °F)	<ul style="list-style-type: none"> <li>Lever</li> <li>Top push roller</li> <li>Side push vertical roller</li> <li>Side push horizontal roller</li> </ul>	NEMA 4, 6P, 12, 13, and IP67	✓	





## Ultrasonic Sensors

Allen-Bradley ultrasonic sensors detect solid or liquid targets by using sound waves. They are ideal for sensing targets – such as clear, shiny, or non-reflective objects – that can be challenging for other sensing technologies.

## Additional Sensing Products

In addition to our comprehensive line of presence sensors and switches, Rockwell Automation offers a full line of complementary technologies. To learn about these products and more Allen-Bradley components, go to: <http://ab.rockwellautomation.com/allenbradley>.

Product	Product Features	Housing Diameter (mm)	Sensing Direction	Sensing Range (mm (in.))	Single Discrete (PNP)	Dual Discrete (PNP)	Analog 4...20 mA	Analog 0...10V	Dual Discrete (PNP) and One Analog (0...10V)	Dual Discrete (PNP) and One Analog (4...20 mA)	
<b>873P</b> 	<ul style="list-style-type: none"> <li>Pushbutton teach process and multiple LED indicators simplify programming of sensor outputs and set points</li> <li>Sensing up to 6 m (19.6 ft)</li> <li>Synchronization on select models prevents crosstalk</li> <li>IP67-rated 18 mm and 30 mm PBT plastic threaded barrels for use in tough industrial applications</li> <li>Window or One Set Point output function</li> <li>Selectable N.O./N.C. Outputs when in windows mode</li> </ul>	18	Straight	50...400 (1.96...15.74)							
		18	Straight	100...900 (3.93...35.43)							
		18	Straight	200...2200 (7.87...86.61)	✓	✓	✓	✓			
		30	Straight	200...2500 (7.87...98.42)							
		30	Straight	250...3500 (9.84...137.79)						✓	✓
		30	Straight	350...6000 (13.8...236.2)							
<b>873M</b> 	<ul style="list-style-type: none"> <li>Nickel-plated brass 18 mm cylindrical or right-angle threaded barrel provides ease of mounting and reduces installation time</li> <li>IP67-rated</li> <li>Windows teaching allows sensing range to be defined inside a user-taught sensing area for both discrete and analog models. The user can achieve superior background suppression</li> <li>Programming can be accomplished by remote teach or optional programming cable</li> <li>Bright LEDs allow the user to monitor power, output and margin from any direction - reducing time required for setup and troubleshooting</li> <li>Selectable N.O./N.C. Output</li> </ul>	18	Straight	30...300 (1.18...11.8)							
		18	Right angle	30...300 (1.18...11.8)							
		18	Straight	50...800 (1.97...31.5)	✓	✓	✓				
		18	Right angle	50...800 (1.97...31.5)							



### Solid-State Condition Sensors

Rockwell Automation offers an impressive line of Allen-Bradley solid-state condition sensing products to meet virtually every application need. With models capable of detecting pressure, temperature, flow and level, Allen-Bradley® condition sensors and switches offer exceptional control for automatic operation of machines and processes.



### Encoders

Today's high performance digital servo drive systems require encoders to provide absolute feedback for position control and high resolution incremental feedback for speed control. Rockwell Automation offers a full line of general purpose incremental and absolute encoders as well as Sine Cosine and EtherNet/IP encoders compatible with a variety of motor control products for a wide range of industrial applications.



### RFID

Industrial Radio Frequency Identification (RFID) systems are a rugged and reliable way to track and document products as they move through the manufacturing process. Unlike the bar code systems used for similar, less demanding applications, Allen-Bradley industrial RFID systems are designed to withstand harsh environments. Plus, reusable read/write tags allow for flexibility in information and application.



### Light Arrays

Allen-Bradley light array sensors create a sensing field instead of a single sensing beam. Therefore, light arrays are capable of detecting or measuring targets over a wider area than traditional photoelectric sensors. This makes them ideal for detecting oddly shaped parts, products with gaps or spaces, or inconsistently positioned targets, at a fraction of the cost of using multiple sensor pairs.



# Connectivity & Network Media Solutions

Rockwell Automation offers a full portfolio of Allen-Bradley Connection Systems and Network Media solutions that provide seamless connectivity for your Integrated Architecture and components. We offer one of the most extensive portfolios in the industry, so whether it's a standard cable or customized length, you can get the product you need, when you need it.

- Non-Network Connectivity
- Ethernet Media
- DeviceNet Media
- Safety Connectivity



## Local Distributor

Visit our website to find your local Distributor.

[www.rockwellautomation.com/distributor](http://www.rockwellautomation.com/distributor)



## The Connected Enterprise

Learn more about the Connected Enterprise transforms real-time data, from intelligent assets and multi-disciplined control from a plant, or a remote site into actionable information.

[www.rockwellautomation.com/go/lit/ce](http://www.rockwellautomation.com/go/lit/ce)



## Product Selection Toolbox

Our powerful range of product selection and system configuration tools assist you in choosing and applying our products.

[www.rockwellautomation.com/en/e-tools](http://www.rockwellautomation.com/en/e-tools)



Rockwell Automation, Inc. (NYSE:ROK), the world's largest company dedicated to industrial automation, makes its customers more productive and the world more sustainable. Throughout the world, our flagship Allen-Bradley® and Rockwell Software® product brands are recognized for innovation and excellence.



Connect with us.

Allen-Bradley, ClearSight, ColorSight, LaserSight, MiniSight, RightSight, Rockwell Automation, Series 9000, VersaCube, VisiSight, WorldClamp, and WorldProx are trademarks of Rockwell Automation, Inc. Trademarks not belonging to Rockwell Automation are property of their respective companies.

[www.rockwellautomation.com](http://www.rockwellautomation.com)

### Power, Control and Information Solutions Headquarters

Americas: Rockwell Automation, 1201 South Second Street, Milwaukee, WI 53204-2496 USA, Tel: (1) 414.382.2000, Fax: (1) 414.382.4444

Europe/Middle East/Africa: Rockwell Automation, Vorstlaan/Boulevard du Souverain 36, 1170 Brussels, Belgium, Tel: (32) 2 663 0600, Fax: (32) 2 663 0640

Asia Pacific: Rockwell Automation, Level 14, Core F, Cyberport 3, 100 Cyberport Road, Hong Kong, Tel: (852) 2887 4788, Fax: (852) 2508 1846