

MODEL PAX® – 1/8 DIN ANALOG INPUT PANEL METERS



- PROCESS, VOLTAGE, CURRENT, TEMPERATURE, AND STRAIN GAGE INPUTS
- 5-DIGIT 0.56" RED SUNLIGHT READABLE DISPLAY
- VARIABLE INTENSITY DISPLAY
- 16 POINT SCALING FOR NON-LINEAR PROCESSES
- PROGRAMMABLE FUNCTION KEYS/USER INPUTS
- 9 DIGIT TOTALIZER (INTEGRATOR) WITH BATCHING
- OPTIONAL CUSTOM UNITS OVERLAY W/BACKLIGHT
- FOUR SETPOINT ALARM OUTPUTS (W/OPTION CARD)
- COMMUNICATION AND BUS CAPABILITIES (W/OPTION CARD)
- RETRANSMITTED ANALOG OUTPUT (W/OPTION CARD)
- CRIMSON® PROGRAMMING SOFTWARE
- NEMA 4X/IP65 SEALED FRONT BEZEL

GENERAL DESCRIPTION

The PAX® Analog Panel Meters offer many features and performance capabilities to suit a wide range of industrial applications. Available in five different models to handle various analog inputs, including DC Voltage/Current, AC Voltage/Current, Process, Temperature, and Strain Gage Inputs. Refer to pages 4 through 6 for the details on the specific models. The option cards allow the opportunity to configure the meter for present applications, while providing easy upgrades for future needs.

The meters employ a bright 0.56" LED display. The unit is available with a red sunlight readable or a standard green LED. The intensity of display can be adjusted from dark room applications up to sunlight readable, making it ideal for viewing in bright light applications.

The meters provide a MAX and MIN reading memory with programmable capture time. The capture time is used to prevent detection of false max or min readings which may occur during start-up or unusual process events.

The signal totalizer (integrator) can be used to compute a time-input product. This can be used to provide a readout of totalized flow, calculate service intervals of motors or pumps, etc. The totalizer can also accumulate batch weighing operations.

Optional digital output cards provide the meter with up to four setpoint outputs. The cards are available as dual relay, quad relay, quad sinking transistor, quad sourcing transistor/SSR drive, or dual triac/dual SSR drive outputs. The setpoint alarms can be configured to suit a variety of control and alarm requirements.

Communication and Bus Capabilities are also available as option cards. These include RS232, RS485, Modbus, DeviceNet, and Profibus-DP. Readout values and setpoint alarm values can be controlled through the bus. Additionally, the meters have a feature that allows a remote computer to directly control the outputs of the meter. With an RS232 or RS485 card installed, it is possible to configure the meter using a Windows® based program. The configuration data can be saved to a file for later recall.

A linear DC output signal is available as an optional card. The card provides either 20 mA or 10 V signals. The output can be scaled independent of the input range and can track either the input, totalizer, max or min readings.

Once the meters have been initially configured, the parameter list may be locked out from further modification in its entirety or only the setpoint values can be made accessible.

The meters have been specifically designed for harsh industrial environments. With NEMA 4X/IP65 sealed bezel and extensive testing of noise effects to CE requirements, the meter provides a tough yet reliable application solution.

SAFETY SUMMARY

All safety related regulations, local codes as well as instructions that appear in this document or on equipment must be observed to ensure personal safety and to prevent damage to either the device or equipment connected to it.

Do not use these products to replace proper safety interlocking. No software-based device (or any other solid-state device) should ever be designed to be responsible for the maintenance of personnel safety or consequential equipment not equipped with safeguards. Red Lion disclaims any responsibility for damages, either direct or consequential, that result from the use of this equipment in a manner not consistent with these specifications.



CAUTION: Risk of Danger
 Read complete instructions prior to installation and operation of the unit.



CAUTION: Risk of electric shock.

DIMENSIONS In inches (mm)

Note: Recommended minimum clearance (behind the panel) for mounting clip installation is 2.1" (53.4) H x 5.0" (127) W.

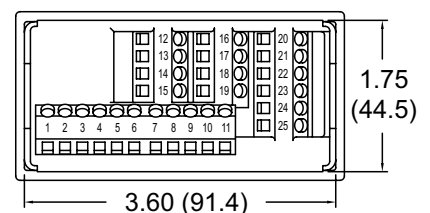
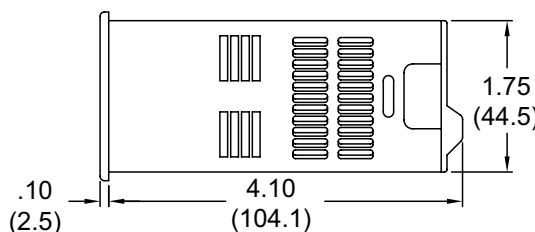
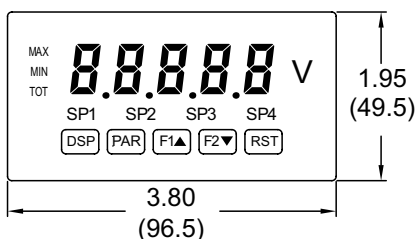
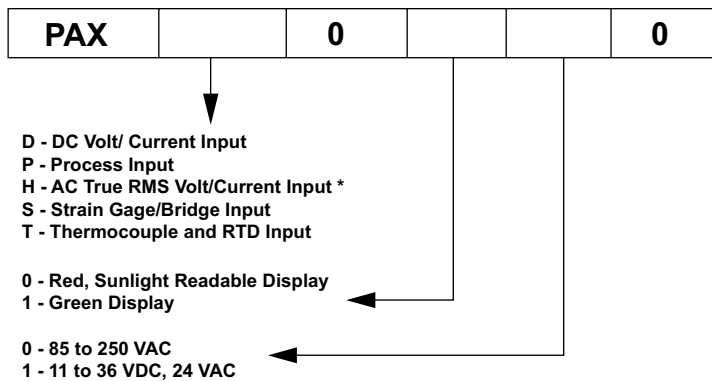

TABLE OF CONTENTS

Ordering Information	2	Setting the Jumpers	8
General Meter Specifications	3	Installing Option Cards	10
Universal DC Input Panel Meter	4	Wiring the Meter	11
Process Input Panel Meter	4	Reviewing the Front Buttons and Display	14
AC True RMS Voltage and Current Meter	5	Programming the Meter	15
Strain Gage Input Panel Meter	5	Factory Service Operations	30
Thermocouple and RTD Input Meter	6	Parameter Value Chart	32
Option Cards	7	Programming Overview	34
Installing the Meter	8		

ORDERING INFORMATION

Meter Part Numbers



* PAXH is only available with 85-250 VAC power supply.

Option Card and Accessories Part Numbers

TYPE	MODEL NO.	DESCRIPTION	PART NUMBER
Option Cards	PAXCDS	Dual Setpoint Relay Output Card	PAXCDS10
		Quad Setpoint Relay Output Card	PAXCDS20
		Quad Setpoint Sinking Open Collector Output Card	PAXCDS30
		Quad Setpoint Sourcing Open Collector Output Card	PAXCDS40
		Dual Triac/Dual SSR Drive Output Card	PAXCDS50
		Quad Form C Relay Output Card	PAXCDS60 *
	PAXCDC	RS485 Serial Communications Card with Terminal Block	PAXCDC10
		Extended RS485 Serial Communications Card with Dual RJ11 Connector	PAXCDC1C
		RS232 Serial Communications Card with Terminal Block	PAXCDC20
		Extended RS232 Serial Communications Card with 9 Pin D Connector	PAXCDC2C
		DeviceNet Communications Card	PAXCDC30
		Modbus Communications Card	PAXCDC40
		Extended Modbus Communications Card with Dual RJ11 Connector	PAXCDC4C
	PAXCDL	Analog Output Card	PAXCDL10
PAXUSB	PAX USB Programming Card	PAXUSB00	
Accessories	CBLUSB	USB Programming Cable Type A-Mini B	CBLUSB01
	PAXLBK	Units Label Kit Accessory (Not required for PAXT)	PAXLBK10

* This card is not suitable for use in older PAX models. For proper installation, a case knock-out feature must be present on the top surface of the PAX case. This feature began to be introduced to the standard PAX units in July of 2014 (2614).

Crimson® configuration software is available as a free download from <http://www.redlion.net>

GENERAL METER SPECIFICATIONS

1. **DISPLAY:** 5 digit, 0.56" (14.2 mm) red sunlight readable or standard green LEDs, (-19999 to 99999)
 2. **POWER:**
AC Versions:
AC Power: 85 to 250 VAC, 50/60 Hz, 15 VA
Isolation: 2300 Vrms for 1 min. to all inputs and outputs.
DC Versions (Not available on PAXH):
DC Power: 11 to 36 VDC, 11 W
(derate operating temperature to 40° C if operating <15 VDC and three option cards are installed)
AC Power: 24 VAC, ± 10%, 50/60 Hz, 15 VA
Isolation: 500 Vrms for 1 min. to all inputs and outputs (50 V working).
 3. **ANNUNCIATORS:**
MAX - maximum readout selected
MIN - minimum readout selected
TOT - totalizer readout selected, flashes when total overflows
SP1 - setpoint alarm 1 is active
SP2 - setpoint alarm 2 is active
SP3 - setpoint alarm 3 is active
SP4 - setpoint alarm 4 is active
Units Label - optional units label backlight
 4. **KEYPAD:** 3 programmable function keys, 5 keys total
 5. **A/D CONVERTER:** 16 bit resolution
 6. **UPDATE RATES:**
A/D conversion rate: 20 readings/sec.
Step response: internal zero correction cannot be disabled
700 msec. max. (digital filter disabled, internal zero correction cannot be disabled)
PAXH Only: 1 sec max. to within 99% of final readout value (digital filter disabled)
Display update rate: 1 to 20 updates/sec.
Setpoint output on/off delay time: 0 to 3275 sec.
Analog output update rate: 0 to 10 sec
Max./Min. capture delay time: 0 to 3275 sec.
 7. **DISPLAY MESSAGES:**
"OLOL" - Appears when measurement exceeds + signal range.
"ULUL" - Appears when measurement exceeds - signal range
PAXT: "SHrt" - Appears when shorted sensor is detected. (RTD only)
PAXT: "OPEN" - Appears when open sensor is detected.
". . ." - Appears when display values exceed + display range.
"- . ." - Appears when display values exceed - display range.
"E . ." - Appears when Totalizer exceeds 9 digits.
"h . ." - Denotes the high order display of the Totalizer.
 8. **INPUT CAPABILITIES:** See specific product specifications, pages 4-6
 9. **EXCITATION POWER:** See specific product specifications, pages 4-6
 10. **LOW FREQUENCY NOISE REJECTION:** (Does not apply to PAXH)
Normal Mode: > 60 dB @ 50 or 60 Hz ±1%, digital filter off
Common Mode: >100 dB, DC to 120 Hz
 11. **USER INPUTS:** Three programmable user inputs
Max. Continuous Input: 30 VDC
Isolation To Sensor Input Common: Not isolated. (Not PAXH)
PAXH: Isolation to Sensor Input Common: 1400 Vrms for 1 min.
Working Voltage: 125 V
Response Time: 50 msec. max.
Logic State: Jumper selectable for sink/source logic
- | INPUT STATE | SINKING INPUTS
22 K Ω pull-up to +5 V | SOURCING INPUTS
22 K Ω pull-down |
|-------------|---|--|
| Active | $V_{IN} < 0.9$ VDC | $V_{IN} > 3.6$ VDC |
| Inactive | $V_{IN} > 3.6$ VDC | $V_{IN} < 0.9$ VDC |
12. **TOTALIZER:**
Function:
Time Base: second, minute, hour, or day
Batch: Can accumulate (gate) input display from a user input
Time Accuracy: 0.01% typical
Decimal Point: 0 to 0.0000
Scale Factor: 0.001 to 65.000
Low Signal Cut-out: -19,999 to 99,999
Total: 9 digits, display alternates between high order and low order readouts
 13. **CUSTOM LINEARIZATION:**
Data Point Pairs: Selectable from 2 to 16
Display Range: -19,999 to 99,999
Decimal Point: 0 to 0.0000
PAXT: Ice Point Compensation: user value (0.00 to 650.00 μ V/°C)
 14. **MEMORY:** Nonvolatile E²PROM retains all programmable parameters and display values.
 15. **ENVIRONMENTAL CONDITIONS:**
Operating Temperature Range: 0 to 50°C (0 to 45°C with all three option cards installed)
Vibration to IEC 68-2-6: Operational 5 to 150 Hz, 2 g.
Shock to IEC 68-2-27: Operational 25 g (10 g relay).
Storage Temperature Range: -40 to 60°C
Operating and Storage Humidity: 0 to 85% max. RH non-condensing
Altitude: Up to 2000 meters
 16. **CERTIFICATIONS AND COMPLIANCES:**
CE Approved
EN 61326-1 Immunity to Industrial Locations
Emission CISPR 11 Class A
Safety requirements for electrical equipment for measurement control, and laboratory use:
EN 61010-1: General Requirements
EN 61010-2-030: Particular Requirements for Testing and Measuring Circuits
RoHS Compliant
UL Listed Component: File #E179259
Type 4X Enclosure rating (Face only)
IP65 Enclosure rating (Face only)
IP20 Enclosure rating (Rear of unit)
Refer to EMC Installation Guidelines section of the bulletin for additional information.
 17. **CONNECTIONS:** High compression cage-clamp terminal block
Wire Strip Length: 0.3" (7.5 mm)
Wire Gauge: 30-14 AWG copper wire
Torque: 4.5 inch-lbs (0.51 N-m) max.
 18. **CONSTRUCTION:** This unit is rated for NEMA 4X/IP65 outdoor use. IP20 Touch safe. Installation Category II, Pollution Degree 2. One piece bezel/case. Flame resistant. Synthetic rubber keypad. Panel gasket and mounting clip included.
 19. **WEIGHT:** 10.4 oz. (295 g)

MODEL PAXD - UNIVERSAL DC INPUT

- FOUR VOLTAGE RANGES (300 VDC Max)
- FIVE CURRENT RANGES (2A DC Max)
- THREE RESISTANCE RANGES (10K Ohm Max)
- SELECTABLE 24 V, 2 V, 1.75 mA EXCITATION

PAXD SPECIFICATIONS

INPUT RANGES:

INPUT RANGE	ACCURACY* (18 to 28°C)	ACCURACY* (0 to 50°C)	IMPEDANCE/ COMPLIANCE	MAX CONTINUOUS OVERLOAD	RESOLUTION
±200 µADC	0.03% of reading +0.03 µA	0.12% of reading +0.04 µA	1.11 Kohm	15 mA	10 nA
±2 mADC	0.03% of reading +0.3 µA	0.12% of reading +0.4 µA	111 ohm	50 mA	0.1 µA
±20 mADC	0.03% of reading +3 µA	0.12% of reading +4 µA	11.1 ohm	150 mA	1 µA
±200 mADC	0.05% of reading +30 µA	0.15% of reading +40 µA	1.1 ohm	500 mA	10 µA
±2 ADC	0.5% of reading +0.3 mA	0.7% of reading +0.4 mA	0.1 ohm	3 A	0.1 mA
±200 mVDC	0.03% of reading +30 µV	0.12% of reading +40 µV	1.066 Mohm	100 V	10 µV
±2 VDC	0.03% of reading +0.3 mV	0.12% of reading +0.4 mV	1.066 Mohm	300 V	0.1 mV
±20 VDC	0.03% of reading +3 mV	0.12% of reading +4 mV	1.066 Mohm	300 V	1 mV
±300 VDC	0.05% of reading +30 mV	0.15% of reading +40 mV	1.066 Mohm	300 V	10 mV
100 ohm	0.05% of reading +0.03 ohm	0.2% of reading +0.04 ohm	0.175 V	30 V	0.01 ohm
1000 ohm	0.05% of reading +0.3 ohm	0.2% of reading +0.4 ohm	1.75 V	30 V	0.1 ohm
10 Kohm	0.05% of reading +1 ohm	0.2% of reading +1.5 ohm	17.5 V	30 V	1 ohm

* After 20 minute warm-up. Accuracy is specified in two ways: Accuracy over an 18 to 28°C and 10 to 75% RH environment; and accuracy over a 0 to 50°C and 0 to 85% RH (non-condensing environment). Accuracy over the 0 to 50°C range includes the temperature coefficient effect of the meter.

EXCITATION POWER:

Transmitter Power: 24 VDC, ±5%, regulated, 50 mA max.

Reference Voltage: 2 VDC, ±2%

Compliance: 1 kohm load min. (2 mA max.)

Temperature coefficient: 40 ppm/°C max.

Reference Current: 1.75 mADC, ±2%

Compliance: 10 kohm load max.

Temperature coefficient: 40 ppm/°C max.

MODEL PAXP - PROCESS INPUT

- DUAL RANGE INPUT (20 mA or 10 VDC)
- 24 VDC TRANSMITTER POWER

PAXP SPECIFICATIONS

SENSOR INPUTS:

INPUT (RANGE)	ACCURACY* (18 to 28°C)	ACCURACY* (0 to 50°C)	IMPEDANCE/ COMPLIANCE	MAX CONTINUOUS OVERLOAD	DISPLAY RESOLUTION
20 mA (-2 to 26 mA)	0.03% of reading +2 µA	0.12% of reading +3 µA	20 ohm	150 mA	1 µA
10 VDC (-1 to 13 VDC)	0.03% of reading +2 mV	0.12% of reading +3 mV	500 Kohm	300 V	1 mV

* After 20 minute warm-up. Accuracy is specified in two ways: Accuracy over an 18 to 28°C and 10 to 75% RH environment; and accuracy over a 0 to 50°C and 0 to 85%RH (non-condensing environment). Accuracy over the 0 to 50°C range includes the temperature coefficient effect of the meter.

EXCITATION POWER:

Transmitter Power: 24 VDC, ±5%, regulated, 50 mA max.

MODEL PAXH - AC TRUE RMS VOLT AND CURRENT

- FOUR VOLTAGE RANGES (300 VAC Max)
- FIVE CURRENT RANGES (5 A Max)
- ACCEPTS AC OR DC COUPLED INPUTS
- THREE WAY ISOLATION: POWER, INPUT AND OUTPUTS

PAXH SPECIFICATIONS

INPUT RANGES:

 Isolation To Option Card Commons and User Input Commons: 125 Vrms
 Isolation To AC Power Terminals: 250 Vrms

INPUT RANGE	ACCURACY*	IMPEDANCE (60 Hz)	MAX CONTINUOUS OVERLOAD	MAX DC BLOCKING	RESOLUTION
200 mV	0.1% of reading +0.4 mV	686 Kohm	30 V	±10 V	0.01 mV
2 V	0.1% of reading +2 mV	686 Kohm	30 V	±50 V	0.1 mV
20 V	0.1% of reading +20 mV	686 Kohm	300 V	±300 V	1 mV
300 V	0.2% of reading +0.3 V	686 Kohm	300 V	±300 V***	0.1 V
200 µA	0.1% of reading +0.4 µA	1.11 Kohm	15 mA	±15 mA	0.01 µA
2 mA	0.1% of reading +2 µA	111 ohm	50 mA	±50 mA	0.1 µA
20 mA	0.1% of reading +20 µA	11.1 ohm	150 mA	±150 mA	1 µA
200 mA	0.1% of reading +0.2 mA	1.1 ohm	500 mA	±500 mA	10 µA
5 A	0.5% of reading +5 mA	0.02 ohm	7 A**	±7 A***	1 mA

*Conditions for accuracy specification:

- 20 minutes warmup
- 18-28°C temperature range, 10-75% RH non-condensing
- 50 Hz - 400 Hz sine wave input with 1.414 crest factor
- 1% to 100% of range

For conditions outside the above listed:

Temperature from 0-18 and 28-50°C: Add 0.1% reading + 20 counts error
 Crest factors:

- 1-3: Add 0.2% reading + 10 counts error
- 3-5: Add 1% reading

DC component: Add 0.5% reading + 10 counts

20-50 Hz and 400-10 KHz: Add 1% reading + 20 counts error

** Non-repetitive surge rating: 15 A for 5 seconds

*** Inputs are direct coupled to the input divider and shunts. Input signals with high DC component levels may reduce the usable range.

MAX CREST FACTOR (Vp/VRMS): 5 @ Full Scale Input

INPUT COUPLING: AC or AC and DC

INPUT CAPACITANCE: 10 pF

COMMON MODE VOLTAGE: 125 VAC working

COMMON MODE REJECTION: (DC to 60 Hz) 100 dB

MODEL PAXS - STRAIN GAGE INPUT

- LOAD CELL, PRESSURE AND TORQUE BRIDGE INPUTS
- DUAL RANGE INPUT: ±24 mV OR ±240 mV
- SELECTABLE 5 VDC OR 10 VDC BRIDGE EXCITATION
- PROGRAMMABLE AUTO-ZERO TRACKING

PAXS SPECIFICATIONS

SENSOR INPUTS:

INPUT RANGE	ACCURACY* (18 to 28 °C)	ACCURACY* (0 to 50 °C)	IMPEDANCE	MAX CONTINUOUS OVERLOAD	RESOLUTION
±24 mVDC	0.02% of reading +3 µV	0.07% of reading +4 µV	100 Mohm	30 V	1 µV
±240 mVDC	0.02% of reading +30 µV	0.07% of reading +40 µV	100 Mohm	30 V	10 µV

* After 20 minute warm-up. Accuracy is specified in two ways: Accuracy over an 18 to 28 °C and 10 to 75% RH environment; and accuracy over a 0 to 50 °C and 0 to 85% RH (non-condensing environment). Accuracy over the 0 to 50 °C range includes the temperature coefficient effect of the meter.

CONNECTION TYPE: 4-wire bridge (differential)
 2-wire (single-ended)

COMMON MODE RANGE (w.r.t. input common): 0 to +5 VDC
 Rejection: 80 dB (DC to 120 Hz)

BRIDGE EXCITATION :

Jumper Selectable: 5 VDC @ 65 mA max., ±2%

10 VDC @ 125 mA max., ±2%

Temperature coefficient (ratio metric): 20 ppm/°C max.

MODEL PAXT - THERMOCOUPLE AND RTD INPUT

- THERMOCOUPLE AND RTD INPUTS
- CONFORMS TO ITS-90 STANDARDS
- CUSTOM SCALING FOR NON-STANDARD PROBES
- TIME-TEMPERATURE INTEGRATOR

PAXT SPECIFICATIONS

READOUT:

Resolution: Variable: 0.1, 0.2, 0.5, or 1, 2, or 5 degrees

Scale: F or C

Offset Range: -19,999 to 99,999 display units

THERMOCOUPLE INPUTS:

Input Impedance: 20 MΩ

Lead Resistance Effect: 0.03μV/ohm

Max. Continuous Overvoltage: 30 V

INPUT TYPE	RANGE	ACCURACY* (18 to 28 °C)	ACCURACY* (0 to 50 °C)	STANDARD	WIRE COLOR	
					ANSI	BS 1843
T	-200 to 400°C -270 to -200°C	1.2°C **	2.1°C	ITS-90	(+) blue (-) red	(+) white (-) blue
E	-200 to 871°C -270 to -200°C	1.0°C **	2.4°C	ITS-90	(+) purple (-) red	(+) brown (-) blue
J	-200 to 760°C	1.1°C	2.3°C	ITS-90	(+) white (-) red	(+) yellow (-) blue
K	-200 to 1372°C -270 to -200°C	1.3°C **	3.4°C	ITS-90	(+) yellow (-) red	(+) brown (-) blue
R	-50 to 1768°C	1.9°C	4.0°C	ITS-90	no standard	(+) white (-) blue
S	-50 to 1768°C	1.9°C	4.0°C	ITS-90	no standard	(+) white (-) blue
B	100 to 300°C 300 to 1820°C	3.9°C 2.8°C	5.7°C 4.4°C	ITS-90	no standard	no standard
N	-200 to 1300°C -270 to -200°C	1.3°C **	3.1°C	ITS-90	(+) orange (-) red	(+) orange (-) blue
C (W5/W26)	0 to 2315°C	1.9°C	6.1°C	ASTM E988-90***	no standard	no standard

*After 20 min. warm-up. Accuracy is specified in two ways: Accuracy over an 18 to 28 °C and 15 to 75% RH environment; and Accuracy over a 0 to 50 °C and 0 to 85% RH (non condensing) environment. Accuracy specified over the 0 to 50 °C operating range includes meter tempco and ice point tracking effects. The specification includes the A/D conversion errors, linearization conformity, and thermocouple ice point compensation. Total system accuracy is the sum of meter and probe errors. Accuracy may be improved by field calibrating the meter readout at the temperature of interest.

** The accuracy over the interval -270 to -200 °C is a function of temperature, ranging from 1 °C at -200 °C and degrading to 7 °C at -270 °C. Accuracy may be improved by field calibrating the meter readout at the temperature of interest.

*** These curves have been corrected to ITS-90.

RTD INPUTS:

Type: 3 or 4 wire, 2 wire can be compensated for lead wire resistance

Excitation current: 100 ohm range: 165 μA

10 ohm range: 2.6 mA

Lead resistance: 100 ohm range: 10 ohm/lead max.

10 ohm range: 3 ohms/lead max.

Max. continuous overload: 30 V

INPUT TYPE	RANGE	ACCURACY* (18 to 28 °C)	ACCURACY* (0 to 50 °C)	STANDARD ***
100 ohm Pt alpha = .00385	-200 to 850°C	0.4°C	1.6°C	IEC 751
100 ohm Pt alpha = .003919	-200 to 850°C	0.4°C	1.6°C	no official standard
120 ohm Nickel alpha = .00672	-80 to 260°C	0.2°C	0.5°C	no official standard
10 ohm Copper alpha = .00427	-100 to 260°C	0.4°C	0.9°C	no official standard

CUSTOM RANGE: Up to 16 data point pairs

Input range: -10 to 65 mV

0 to 400 ohms, high range

0 to 25 ohms, low range

Display range: -19999 to 99999

INPUT TYPE	RANGE	ACCURACY* (18 to 28 °C)	ACCURACY* (0 to 50 °C)
Custom mV range	-10 to 65mV (1 μV res.)	0.02% of reading + 4μV	0.12% of reading + 5μV
Custom 100 ohm range	0 to 400 Ω (10 MΩ res.)	0.02% of reading + 0.04 Ω	0.12% of reading + 0.05 Ω
Custom 10 ohm range	0 to 25 Ω (1 MΩ res.)	0.04% of reading + 0.005 Ω	0.20% of reading + 0.007 Ω

ACCESSORIES

UNITS LABEL KIT (PAXLBK) - Not required for PAXT

Each meter has a units indicator with backlighting that can be customized using the Units Label Kit. The backlight is controlled in the programming.

Each PAXT meter is shipped with °F and °C overlay labels which can be installed into the meter's bezel display assembly.

EXTERNAL CURRENT SHUNTS (APSCM)

To measure DC current signals greater than 2 ADC, a shunt must be used. The APSCM010 current shunt converts a maximum 10 ADC signal into 100.0 mV. The APSCM100 current shunt converts a maximum 100 ADC signal into 100.0 mV. The continuous current through the shunt is limited to 115% of the rating.

PROGRAMMING SOFTWARE

Crimson software is a Windows based program that allows configuration of the PAX meter from a PC. Crimson offers standard drop-down menu commands, that make it easy to program the meter. The meter's program can then be saved in a PC file for future use. A PAX serial option card or PAX USB programming card is required to program the meter using the software. Crimson can be downloaded at www.redlion.net.

OPTION CARDS



WARNING: Disconnect all power to the unit before installing option cards.

Adding Option Cards

The PAX and MPAX series meters can be fitted with up to three option cards. The details for each option card can be reviewed in the specification section below. Only one card from each function type can be installed at one time. The function types include Setpoint Alarms (PAXCDS), Communications (PAXCDC), and Analog Output (PAXCDL). The option cards can be installed initially or at a later date.

PAXH Isolation Specifications For All Option Cards

Isolation To Sensor Commons: 1400 Vrms for 1 min.

Isolation to User Input Commons: 500 Vrms for 1 min.

COMMUNICATION CARDS (PAXCDC)

A variety of communication protocols are available for the PAX and MPAX series. Only one of these cards can be installed at a time. When programming the unit via Crimson, a Windows® based program, the RS232, RS485, or USB Cards must be used.

SERIAL COMMUNICATIONS CARD: PAXCDC1_ and PAXCDC2_

Type: RS485 or RS232

Isolation To Sensor & User Input Commons: 500 Vrms for 1 min.

Not Isolated from all other commons.

Data: 7/8 bits

Baud: 300 to 19,200

Parity: No, Odd or Even

Bus Address: Selectable 0 to 99, Max. 32 meters per line (RS485)

Transmit Delay: Selectable for 2 to 50 msec or 50 to 100 msec (RS485)

DEVICENET™ CARD: PAXCDC30

Compatibility: Group 2 Server Only, not UCMM capable

Baud Rates: 125 Kbaud, 250 Kbaud, and 500 Kbaud

Bus Interface: Phillips 82C250 or equivalent with MIS wiring protection per DeviceNet™ Volume I Section 10.2.2.

Node Isolation: Bus powered, isolated node

Host Isolation: 500 Vrms for 1 minute between DeviceNet™ and meter input common.

MODBUS CARD: PAXCDC4_

Type: RS485; RTU and ASCII MODBUS modes

Isolation To Sensor & User Input Commons: 500 Vrms for 1 minute.

Not isolated from all other commons.

Baud Rates: 300 to 38400.

Data: 7/8 bits

Parity: No, Odd, or Even

Addresses: 1 to 247.

Transmit Delay: Programmable; See Transmit Delay explanation.

PROFIBUS-DP CARD: PAXCDC50

Fieldbus Type: Profibus-DP as per EN 50170, implemented with Siemens SPC3 ASIC

Conformance: PNO Certified Profibus-DP Slave Device

Baud Rates: Automatic baud rate detection in the range 9.6 Kbaud to 12 Mbaud

Station Address: 0 to 125, set by rotary switches.

Connection: 9-pin Female D-Sub connector

Network Isolation: 500 Vrms for 1 minute between Profibus network and sensor and user input commons. Not isolated from all other commons.

PAXUSB PROGRAMMING CARD: PAXUSB00

Type: USB Virtual Comms Port

Connection: Type mini B

Isolation To Sensor & User Input Commons: 500 Vrms for 1 min.

Not Isolated from all other commons.

Baud Rate: 300 to 19.2k

Unit Address: 0 to 99; only 1 meter can be configured at a time

SETPOINT CARDS (PAXCDS)

The PAX and MPAX series has 6 available setpoint alarm output option cards. Only one of these cards can be installed at a time. (Logic state of the outputs can be reversed in the programming.)

DUAL RELAY CARD: PAXCDS10

Type: Two FORM-C relays

Isolation To Sensor & User Input Commons: 2000 Vrms for 1 min.

Contact Rating:

One Relay Energized: 5 amps @ 120/240 VAC or 28 VDC (resistive load).

Total current with both relays energized not to exceed 5 amps

Life Expectancy: 100 K cycles min. at full load rating. External RC snubber extends relay life for operation with inductive loads

QUAD RELAY CARD: PAXCDS20

Type: Four FORM-A relays

Isolation To Sensor & User Input Commons: 2300 Vrms for 1 min.

Contact Rating:

One Relay Energized: 3 amps @ 240 VAC or 30 VDC (resistive load).

Total current with all four relays energized not to exceed 4 amps

Life Expectancy: 100K cycles min. at full load rating. External RC snubber extends relay life for operation with inductive loads

QUAD SINKING OPEN COLLECTOR CARD: PAXCDS30

Type: Four isolated sinking NPN transistors.

Isolation To Sensor & User Input Commons: 500 Vrms for 1 min.

Not Isolated from all other commons.

Rating: 100 mA max @ $V_{SAT} = 0.7 V$ max. $V_{MAX} = 30 V$

QUAD SOURCING OPEN COLLECTOR CARD: PAXCDS40

Type: Four isolated sourcing PNP transistors.

Isolation To Sensor & User Input Commons: 500 Vrms for 1 min.

Not Isolated from all other commons.

Rating: Internal supply: 24 VDC $\pm 10\%$, 30 mA max. total

External supply: 30 VDC max., 100 mA max. each output

DUAL TRIAC/DUAL SSR DRIVE CARD: PAXCDS50

Triac:

Type: Isolated, zero crossing detection

Voltage: 260 VAC max., 20 VAC min.

Max Load Current: 1 Amp @ 25°C

0.75 Amp @ 50°C

Total load current with both triacs ON not to exceed 1.5 Amps

Min Load Current: 5 mA

Off State Leakage Current: 1 mA max @ 60 Hz

Operating Frequency: 20-400 Hz

SSR Drive:

Type: Two isolated sourcing PNP Transistors.

Isolation To Sensor & User Input Commons: 500 Vrms for 1 min.

Not Isolated from all other commons.

Rating:

Output Voltage: 18/24 VDC (unit dependent) $\pm 10\%$, 30 mA max. total both outputs

QUAD FORM C RELAY CARD: PAXCDS60

Type: Four FORM-C relays

Isolation To Sensor & User Input Commons: 500 Vrms for 1 min.

Contact Rating:

Rated Load: 3 Amp @ 30 VDC/125 VAC

Total Current With All Four Relays Energized not to exceed 4 amps

Life Expectancy: 100 K cycles min. at full load rating. External RC snubber extends relay life for operation with inductive loads

ALL SETPOINT CARDS

Response Time: internal zero correction cannot be disabled

700 msec. max. (digital filter disabled, internal zero correction cannot be disabled)

LINEAR DC OUTPUT (PAXCDL)

Either a 0(4)-20 mA or 0-10 V retransmitted linear DC output is available from the analog output option card. The programmable output low and high scaling can be based on various display values. Reverse slope output is possible by reversing the scaling point positions.

ANALOG OUTPUT CARD: PAXCDL10 - Self-Powered Output (Active)

Types: 0 to 20 mA, 4 to 20 mA or 0 to 10 VDC

Isolation To Sensor & User Input Commons: 500 Vrms for 1 min.

Not Isolated from all other commons.

Accuracy: 0.17% of FS (18 to 28 °C); 0.4% of FS (0 to 50 °C)

Resolution: 1/3500

Compliance: 10 VDC: 10 K Ω load min., 20 mA: 500 Ω load max.

Update time: internal zero correction cannot be disabled

700 msec. max. (digital filter disabled, internal zero correction cannot be disabled)

1.0 INSTALLING THE METER

Installation

The PAX meets NEMA 4X/IP65 requirements when properly installed. The unit is intended to be mounted into an enclosed panel. Prepare the panel cutout to the dimensions shown. Remove the panel latch from the unit. Slide the panel gasket over the rear of the unit to the back of the bezel. The unit should be installed fully assembled. Insert the unit into the panel cutout.

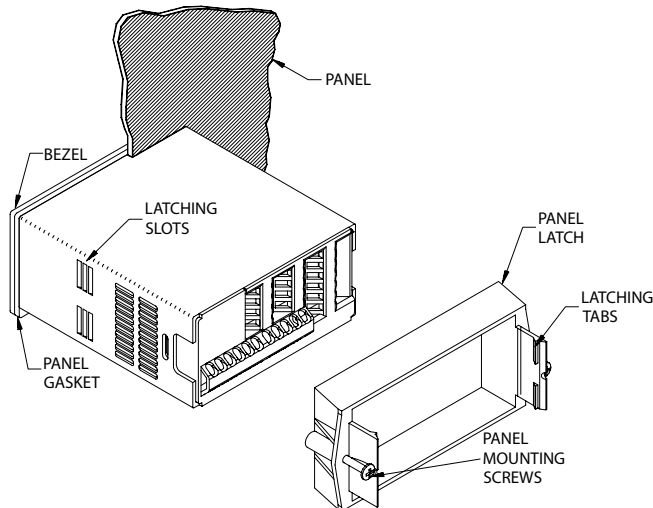

While holding the unit in place, push the panel latch over the rear of the unit so that the tabs of the panel latch engage in the slots on the case. The panel latch should be engaged in the farthest forward slot possible. To achieve a proper seal, tighten the latch screws evenly until the unit is snug in the panel (Torque to approximately 7 in-lbs [79N-cm]). Do not over-tighten the screws.

Installation Environment

The unit should be installed in a location that does not exceed the maximum operating temperature and provides good air circulation. Placing the unit near devices that generate excessive heat should be avoided.

The bezel should be cleaned only with a soft cloth and neutral soap product. Do NOT use solvents. Continuous exposure to direct sunlight may accelerate the aging process of the bezel.

Do not use tools of any kind (screwdrivers, pens, pencils, etc.) to operate the keypad of the unit.

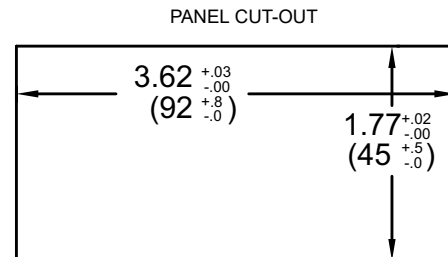

2.0 SETTING THE JUMPERS

The meter can have up to four jumpers that must be checked and / or changed prior to applying power. The following Jumper Selection Figures show an enlargement of the jumper area.

To access the jumpers, remove the meter base from the case by firmly squeezing and pulling back on the side rear finger tabs. This should lower the latch below the case slot (which is located just in front of the finger tabs). It is recommended to release the latch on one side, then start the other side latch.

Input Range Jumper

This jumper is used to select the proper input range. The input range selected in programming must match the jumper setting. Select a range that is high enough to accommodate the maximum input to avoid overloads. The selection is different for each meter. See the Jumper Selection Figure for appropriate meter.

Excitation Output Jumper

If your meter has excitation, this jumper is used to select the excitation range for the application. If excitation is not being used, it is not necessary to check or move this jumper.

User Input Logic Jumper

This jumper selects the logic state of all the user inputs. If the user inputs are not used, it is not necessary to check or move this jumper.

PAXH: Signal Jumper

This jumper is used to select the signal type. For current signals, the jumper is installed. For voltage signals, remove the jumper from the board. (For 2 V inputs, this removed jumper can be used in the "2 V only" location.)

Couple Jumper

This jumper is used for AC / DC couple. If AC couple, then the jumper is removed from the board. If DC couple is used, then the jumper is installed.

PAXD Jumper Selection

Input Range Jumper

One jumper is used for voltage/ohms or current input ranges. Select the proper input range high enough to avoid input signal overload. **Only one jumper is allowed in this area.** Do not have a jumper in both the voltage and current ranges at the same time. Avoid placing the jumper across two ranges.

JUMPER SELECTIONS

The \frown indicates factory setting.

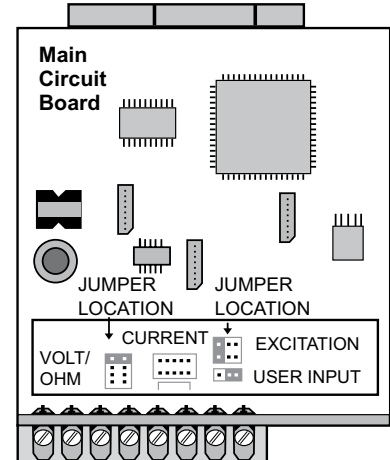
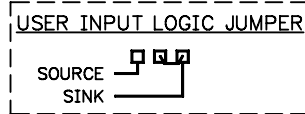
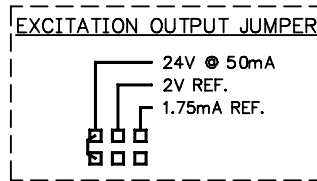
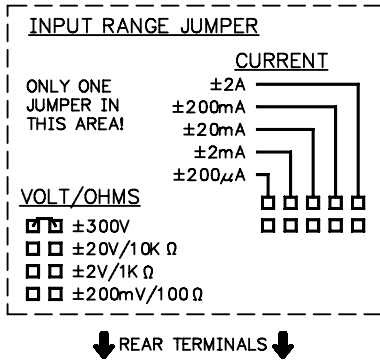

PAXH Jumper Selection



CAUTION: To maintain the electrical safety of the meter, remove unneeded jumpers completely from the meter. Do not move the jumpers to positions other than those specified.

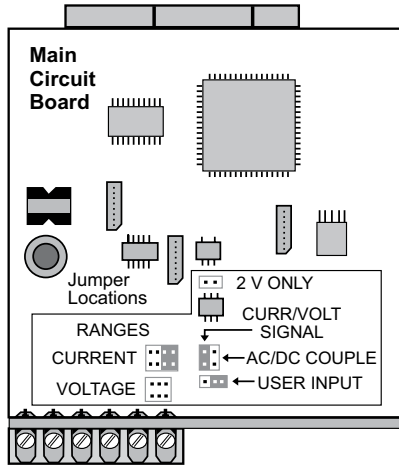

JUMPER SELECTIONS

The \frown indicates factory setting.

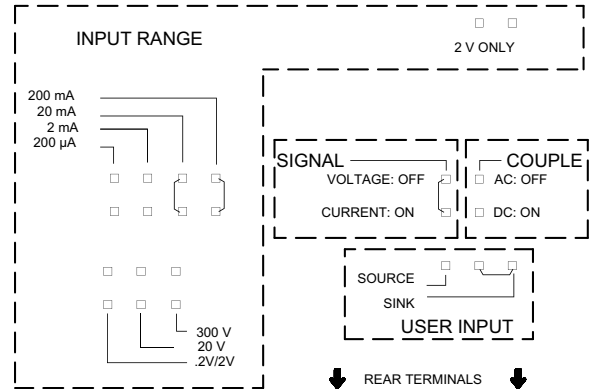

Signal Jumper

One jumper is used for the input signal type. For current signals, the jumper is installed. For voltage signals, remove the jumper from the board. (For 2 V inputs, this removed jumper can be used in the "2 V only" location.)

Couple Jumper

One jumper is used for AC / DC couple. If AC couple is used, then the jumper is removed from the board. If DC couple is used, then the jumper is installed.

Input Range Jumper

For most inputs, one jumper is used to select the input range. However, for the following ranges, set the jumpers as stated:

5 A: Remove all jumpers from the input range.

2 V: Install one jumper in ".2/2V" position and one jumper in "2 V only".

All Other Ranges: One jumper in the selected range only.

Do not have a jumper in both the voltage and current ranges at the same time. Avoid placing a jumper across two ranges.

PAXP Jumper Selection

JUMPER SELECTIONS
The indicates factory setting.

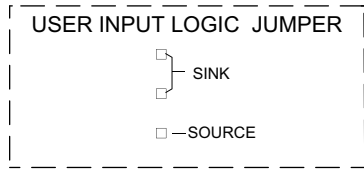

↓ REAR TERMINALS ↓

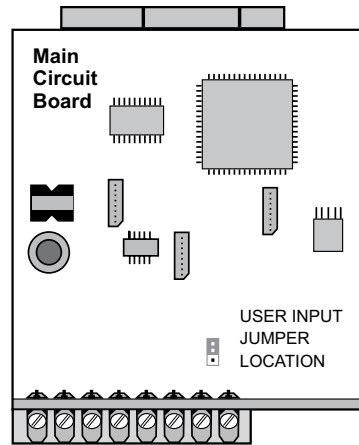

PAXS Jumper Selection

Bridge Excitation

One jumper is used to select bridge excitation to allow use of the higher sensitivity 24 mV input range. Use the 5 V excitation with high output (3 mV/V) bridges. The 5 V excitation also reduces bridge power compared to 10 V excitation.

A maximum of four 350 ohm load cells can be driven by the internal bridge excitation voltage.

JUMPER SELECTIONS
The indicates factory setting.

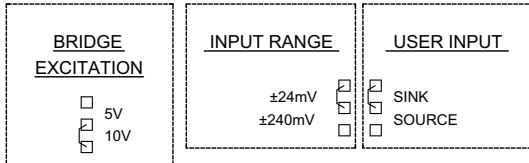

↓ REAR TERMINALS ↓

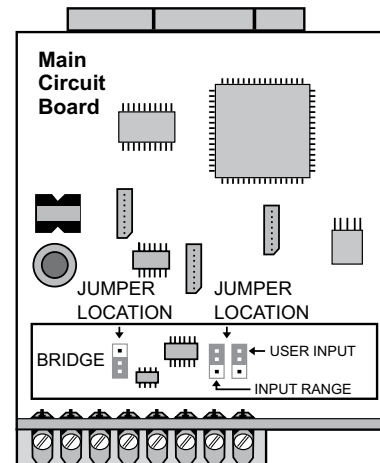

PAXT Jumper Selection

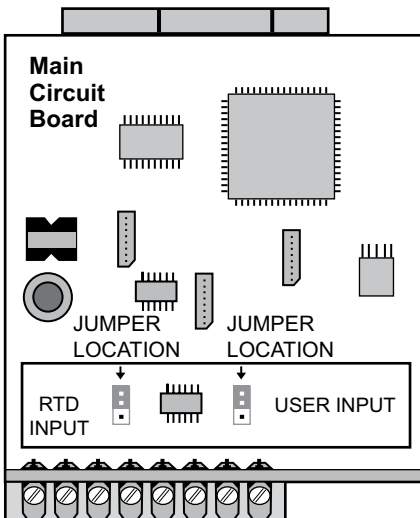

RTD Input Jumper

One jumper is used for RTD input ranges. Select the proper range to match the RTD probe being used. It is not necessary to remove this jumper when not using RTD probes.

JUMPER SELECTIONS
The indicates factory setting.

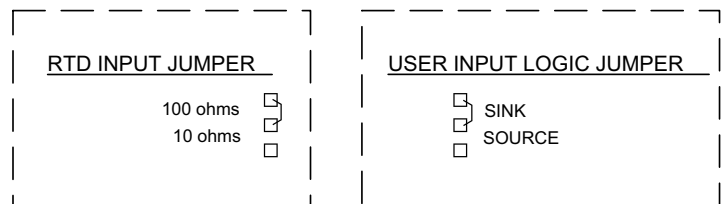

↓ REAR TERMINALS ↓

3.0 INSTALLING OPTION CARDS

Note: For option card specific installation instructions, refer to the literature shipped with the option card.

The option cards are separately purchased cards that perform specific functions. These cards plug into the main circuit board of the meter. The option cards have many unique functions when used with the PAX.



CAUTION: The option card and main circuit board contain static sensitive components. Before handling the cards, discharge static charges from your body by touching a grounded bare metal object. Ideally, handle the cards at a static controlled clean workstation. Also, only handle the cards by the edges. Dirt, oil or other contaminants that may contact the cards can adversely affect circuit operation.

To Install:

1. With the meter removed from the case, locate the option card connector for the card type to be installed. The types are keyed by position with different main circuit board connector locations. When installing the card, hold the meter by the rear terminals and not by the front display board.
2. Install the option card by aligning the card terminals with the slot bay in the rear cover. Be sure the connector is fully engaged and the tab on the option card rests in the alignment slot on the display board.
3. Slide the meter base back into the case. Be sure the rear cover latches fully into the case.
4. Apply the option card label to the bottom side of the meter in the designated area. Do Not Cover the vents on the top surface of the meter. The surface of the case must be clean for the label to adhere properly.

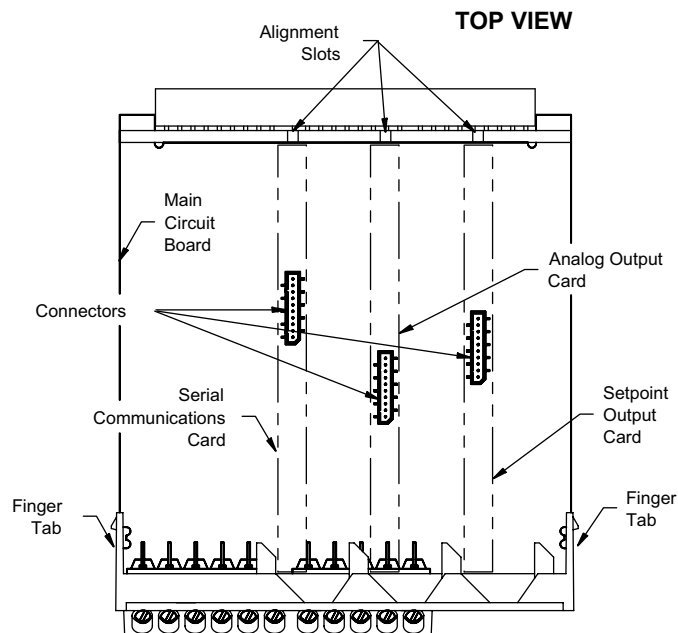

4.0 WIRING THE METER

WIRING OVERVIEW

Electrical connections are made via screw-clamp terminals located on the back of the meter. All conductors should conform to the meter's voltage and current ratings. All cabling should conform to appropriate standards of good installation, local codes and regulations. It is recommended that power supplied to the meter (DC or AC) be protected by a fuse or circuit breaker.

When wiring the meter, compare the numbers embossed on the back of the meter case against those shown in wiring drawings for proper wire position. Strip the wire, leaving approximately 0.3" (7.5 mm) bare lead exposed (stranded wires should be tinned with solder). Insert the lead under the correct screw-clamp terminal and tighten until the wire is secure. (Pull wire to verify tightness.) Each terminal can accept up to one #14 AWG (2.55 mm) wire, two #18 AWG (1.02 mm), or four #20 AWG (0.61 mm).

EMC INSTALLATION GUIDELINES

Although Red Lion Controls products are designed with a high degree of immunity to Electromagnetic Interference (EMI), proper installation and wiring methods must be followed to ensure compatibility in each application. The type of the electrical noise, source or coupling method into a unit may be different for various installations. Cable length, routing, and shield termination are very important and can mean the difference between a successful or troublesome installation. Listed are some EMI guidelines for a successful installation in an industrial environment.

1. A unit should be mounted in a metal enclosure, which is properly connected to protective earth.
2. Use shielded cables for all Signal and Control inputs. The shield connection should be made as short as possible. The connection point for the shield depends somewhat upon the application. Listed below are the recommended methods of connecting the shield, in order of their effectiveness.
 - a. Connect the shield to earth ground (protective earth) at one end where the unit is mounted.
 - b. Connect the shield to earth ground at both ends of the cable, usually when the noise source frequency is over 1 MHz.
3. Never run Signal or Control cables in the same conduit or raceway with AC power lines, conductors, feeding motors, solenoids, SCR controls, and heaters, etc. The cables should be run through metal conduit that is properly grounded. This is especially useful in applications where cable runs are long and portable two-way radios are used in close proximity or if the installation is near a commercial radio transmitter. Also, Signal or Control cables within an enclosure should be routed as far away as possible from contactors, control relays, transformers, and other noisy components.

4. Long cable runs are more susceptible to EMI pickup than short cable runs.
5. In extremely high EMI environments, the use of external EMI suppression devices such as Ferrite Suppression Cores for signal and control cables is effective. The following EMI suppression devices (or equivalent) are recommended:

Fair-Rite part number 0443167251 (Red Lion Controls #FCOR0000)

Line Filters for input power cables:

Schaffner # FN2010-1/07 (Red Lion Controls #LFIL0000)

6. To protect relay contacts that control inductive loads and to minimize radiated and conducted noise (EMI), some type of contact protection network is normally installed across the load, the contacts or both. The most effective location is across the load.

- a. Using a snubber, which is a resistor-capacitor (RC) network or metal oxide varistor (MOV) across an AC inductive load is very effective at reducing EMI and increasing relay contact life.

- b. If a DC inductive load (such as a DC relay coil) is controlled by a transistor switch, care must be taken not to exceed the breakdown voltage of the transistor when the load is switched. One of the most effective ways is to place a diode across the inductive load. Most Red Lion products with solid state outputs have internal zener diode protection. However external diode protection at the load is always a good design practice to limit EMI. Although the use of a snubber or varistor could be used.

Red Lion part numbers: Snubber: SNUB0000

Varistor: ILS11500 or ILS23000

7. Care should be taken when connecting input and output devices to the instrument. When a separate input and output common is provided, they should not be mixed. Therefore a sensor common should NOT be connected to an output common. This would cause EMI on the sensitive input common, which could affect the instrument's operation.

Visit <http://www.redlion.net/emi> for more information on EMI guidelines, Safety and CE issues as they relate to Red Lion products.

4.1 POWER WIRING

AC Power

Terminal 1: VAC
Terminal 2: VAC

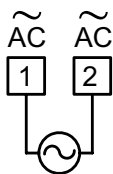

DC Power

Terminal 1: +VDC
Terminal 2: -VDC

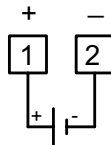

4.2 INPUT SIGNAL WIRING

PAXD INPUT SIGNAL WIRING

Before connecting signal wires, the Input Range Jumper and Excitation Jumper should be verified for proper position.

Voltage Signal (self powered)

Terminal 3: +VDC
Terminal 5: -VDC

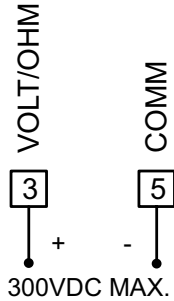

Current Signal (self powered)

Terminal 4: +ADC
Terminal 5: -ADC

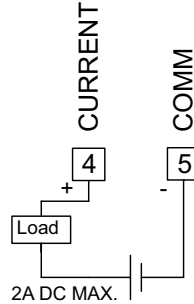

Current Signal (2 wire requiring excitation)

Terminal 4: -ADC
Terminal 6: +ADC
Excitation Jumper: 24 V

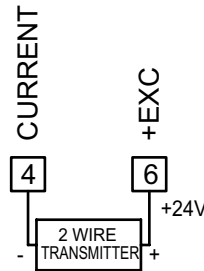

Current Signal (3 wire requiring excitation)

Terminal 4: +ADC (signal)
Terminal 5: -ADC (common)
Terminal 6: +Volt supply
Excitation Jumper: 24 V

Voltage Signal (3 wire requiring excitation)

Terminal 3: +VDC (signal)
Terminal 5: -VDC (common)
Terminal 6: +Volt supply
Excitation Jumper: 24 V

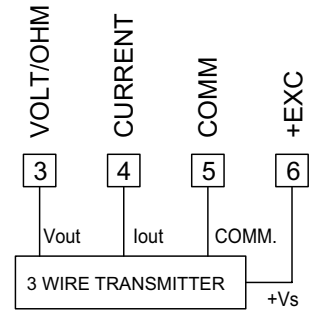

Resistance Signal (3 wire requiring excitation)

Terminal 3: Resistance
Terminal 5: Resistance
Terminal 6: Jumper to terminal 3

Excitation Jumper: 1.75 mA REF.

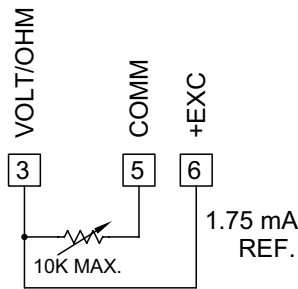

Potentiometer Signal (3 wire requiring excitation)

Terminal 3: Wiper
Terminal 5: Low end of pot.
Terminal 6: High end of pot.
Excitation Jumper: 2 V REF.
Input Range Jumper: 2 Volt

Note: The Apply signal scaling style should be used because the signal will be in volts.

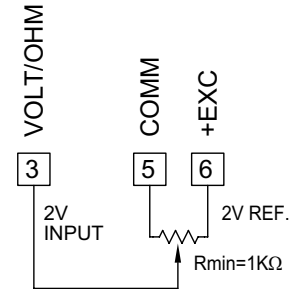

CAUTION: Sensor input common is NOT isolated from user input common. In order to preserve the safety of the meter application, the sensor input common must be suitably isolated from hazardous live earth referenced voltages; or input common must be at protective earth ground potential. If not, hazardous live voltage may be present at the User Inputs and User Input Common terminals. Appropriate considerations must then be given to the potential of the user input common with respect to earth common; and the common of the isolated option cards with respect to input common.

PAXP INPUT SIGNAL WIRING

Voltage Signal (self powered)

Terminal 3: +VDC
Terminal 5: -VDC

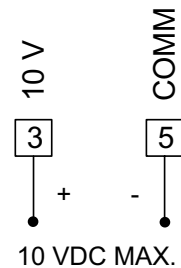

Current Signal (self powered)

Terminal 4: +ADC
Terminal 5: -ADC

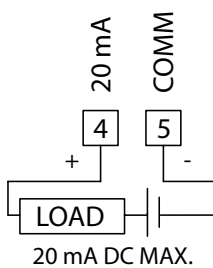

Current Signal (2 wire requiring excitation)

Terminal 4: -ADC
Terminal 6: +ADC

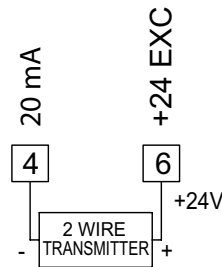

Current Signal (3 wire requiring excitation)

Terminal 4: +ADC (signal)
Terminal 5: -ADC (common)
Terminal 6: +Volt supply

Voltage Signal (3 wire requiring excitation)

Terminal 3: +VDC (signal)
Terminal 5: -VDC (common)
Terminal 6: +Volt supply

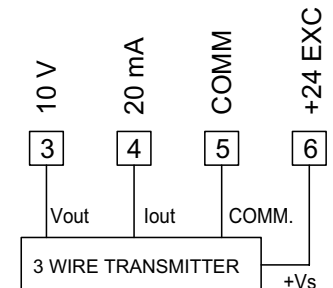

CAUTION: Sensor input common is NOT isolated from user input common. In order to preserve the safety of the meter application, the sensor input common must be suitably isolated from hazardous live earth referenced voltages; or input common must be at protective earth ground potential. If not, hazardous live voltage may be present at the User Inputs and User Input Common terminals. Appropriate considerations must then be given to the potential of the user input common with respect to earth common; and the common of the isolated option cards with respect to input common.

PAXH INPUT SIGNAL WIRING

Before connecting signal wires, the Signal, Input Range and Couple Jumpers should be verified for proper position.

Voltage Signal

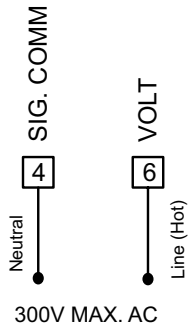

Current Signal (Amps)

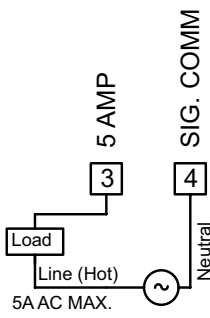

Current Signal (Milliamps)

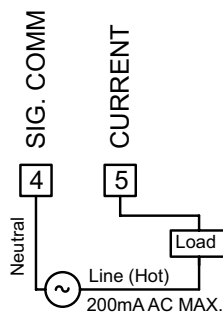

CAUTION: Connect only one input signal range to the meter. Hazardous signal levels may be present on unused inputs.

CAUTION: The isolation rating of the input common of the meter with respect to the option card commons and the user input common Terminal 8 (If used) is 125 Vrms; and 250 Vrms with respect to AC Power (meter Terminals 1 & 2). To be certain that the ratings are not exceeded, these voltages should be verified by a high-voltage meter before wiring the meter.



CAUTION:

1. Where possible, connect the neutral side of the signal (including current shunts) to the input common of the meter. If the input signal is sourced from an active circuit, connect the lower impedance (usually circuit common) to the input signal common of the meter.
2. For phase-to-phase line monitoring where a neutral does not exist, or for any other signal input in which the isolation voltage rating is exceeded, an isolating potential transformer must be used to isolate the input voltage from earth. With the transformer, the input common of the meter can then be earth referenced for safety.
3. When measuring line currents, the use of a current transformer is recommended. If using external current shunts, insert the shunt in the neutral return line. If the isolation voltage rating is exceeded, the use of an isolating current transformer is necessary.
4. If the secondary output leads become open, dangerously high voltage can become present if the primary remains energized. It is recommended that the current transformer be internally protected or that a voltage clamping circuit be employed to prevent high voltage across the CT secondary windings. When using a CT, in order to prevent risk of electric shock, ensure that the CT is installed according to local NEC regulation.

PAXS INPUT SIGNAL WIRING

Before connecting signal wires, the Input Range Jumper should be verified for proper position.

2-Wire Single Ended Input

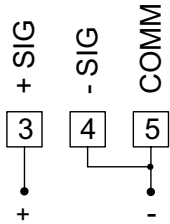

4-Wire Bridge Input

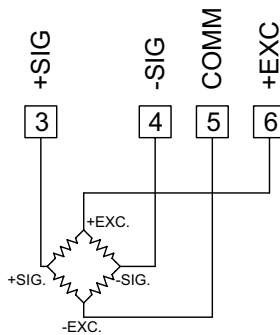

6-Wire Bridge Input

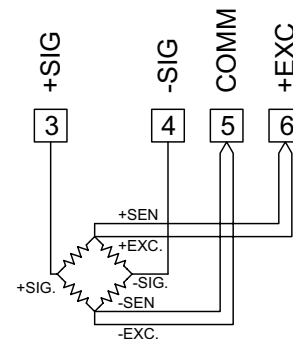

DEADLOAD COMPENSATION

In some cases, the combined deadload and liveload output may exceed the range of the 24 mV input. To use this range, the output of the bridge can be offset a small amount by applying a fixed resistor across one arm of the bridge. This shifts the electrical output of the bridge downward to within the operating range of the meter. A 100 K ohm fixed resistor shifts the bridge output approximately -10 mV (350 ohm bridge, 10 V excitation).

Connect the resistor between +SIG and -SIG. Use a metal film resistor with a low temperature coefficient of resistance.

BRIDGE COMPLETION RESISTORS

For single strain gage applications, bridge completion resistors must be employed externally to the meter. Only use metal film resistors with a low temperature coefficient of resistance.

Load cells and pressure transducers are normally implemented as full resistance bridges and do not require bridge completion resistors.

PAXT INPUT SIGNAL WIRING

Thermocouple

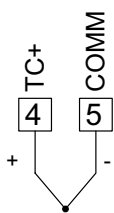

3-Wire RTD

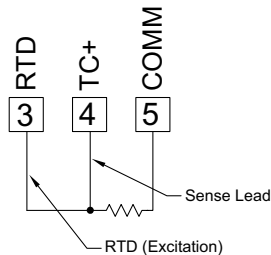

2-Wire RTD

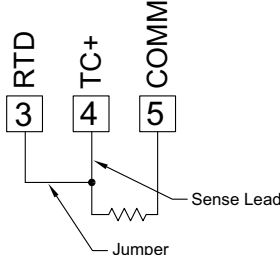

CAUTION: Sensor input common is NOT isolated from user input common. In order to preserve the safety of the meter application, the sensor input common must be suitably isolated from hazardous live earth referenced voltages; or input common must be at protective earth ground potential. If not, hazardous live voltage may be present at the User Inputs and User Input Common terminals. Appropriate considerations must then be given to the potential of the user input common with respect to earth common; and the common of the isolated option cards with respect to input common.

4.3 USER INPUT WIRING

Before connecting the wires, the User Input Logic Jumper should be verified for proper position. If not using User Inputs, then skip this section. Only the appropriate User Input terminal has to be wired.

Sinking Logic

Terminal 8-10: } Connect external switching device between
Terminal 7: } appropriate User Input terminal and User Comm.

In this logic, the user inputs of the meter are internally pulled up to +5 V with 22 K resistance. The input is active when it is pulled low (<0.9 V).

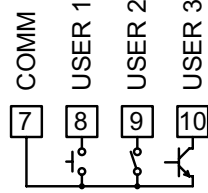

Sourcing Logic

Terminal 8-10: + VDC thru external switching device
Terminal 7: -VDC thru external switching device

In this logic, the user inputs of the meter are internally pulled down to 0 V with 22 K resistance. The input is active when a voltage greater than 3.6 VDC is applied.

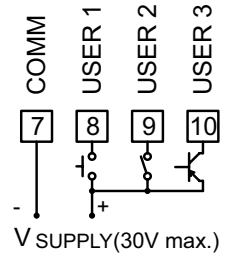

PAXH ONLY

Sinking Logic

Terminals 9-11 } Connect external
Terminal 8 } switching device between
appropriate User Input
terminal and User Comm.

In this logic, the user inputs of the meter are internally pulled up to +5 V with 22 K resistance. The input is active when it is pulled low (<0.9 V).

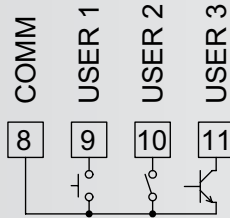

Sourcing Logic

Terminals 9-11: + VDC through external switching device
Terminal 8: -VDC through external switching device

In this logic, the user inputs of the meter are internally pulled down with 22 K resistance. The input is active when a voltage greater than 3.6 VDC is applied.

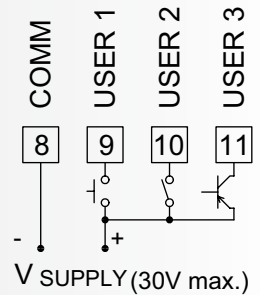

- 4.4 SETPOINT (ALARMS) WIRING
- 4.5 SERIAL COMMUNICATION WIRING
- 4.6 ANALOG OUTPUT WIRING

See appropriate option card bulletin for details.

5.0 REVIEWING THE FRONT BUTTONS AND DISPLAY

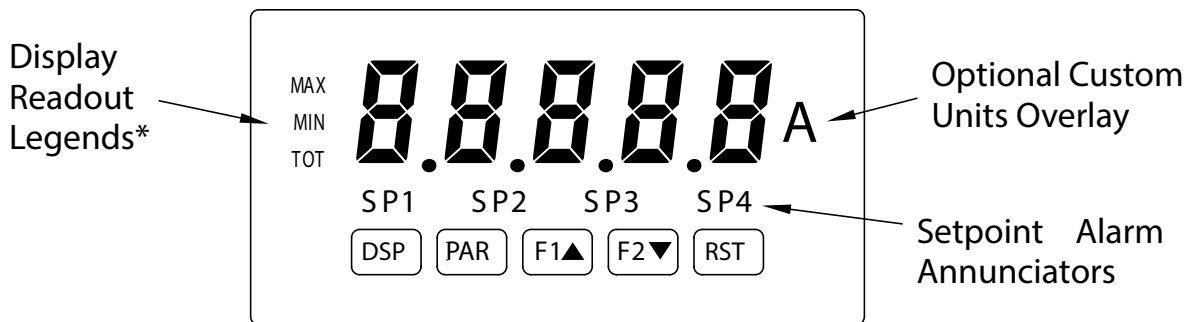

KEY DISPLAY MODE OPERATION

- DSP** Index display through max/min/total/input readouts
- PAR** Access parameter list
- F1▲** Function key 1; hold for 3 seconds for Second Function 1**
- F2▼** Function key 2; hold for 3 seconds for Second Function 2**
- RST** Reset (Function key)**

PROGRAMMING MODE OPERATION

- Quit programming and return to display mode
- Store selected parameter and index to next parameter
- Increase selected parameter value
- Decrement selected parameter value
- Hold with F1▲, F2▼ to scroll value by x1000

* Display Readout Legends may be locked out in Factory Settings.

** Factory setting for the F1, F2, and RST keys is NO mode.

6.0 PROGRAMMING THE METER

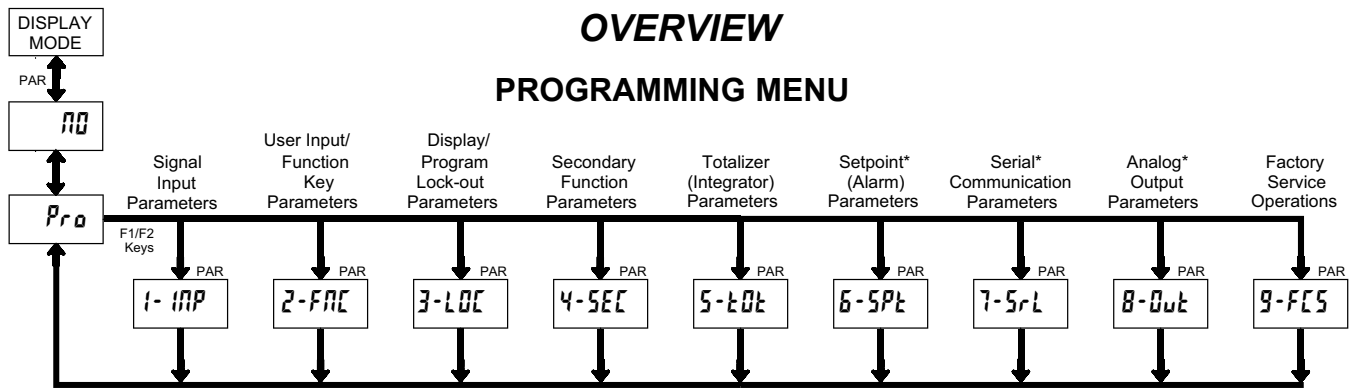

* Only accessible with appropriate option card installed.

DISPLAY MODE

The meter normally operates in the Display Mode. In this mode, the meter displays can be viewed consecutively by pressing the **DSP** key. The annunciators to the left of the display indicate which display is currently shown; Max Value (MAX), Min Value (MIN), or Totalizer Value (TOT). Each of these displays can be locked from view through programming. (See Module 3) The Input Display Value is shown with no annunciator.

PROGRAMMING MODE

Two programming modes are available.

Full Programming Mode permits all parameters to be viewed and modified. Upon entering this mode, the front panel keys change to Programming Mode operations. This mode should not be entered while a process is running, since the meter functions and User Input response may not operate properly while in Full Programming Mode.

Quick Programming Mode permits only certain parameters to be viewed and/or modified. When entering this mode, the front panel keys change to Programming Mode operations, and all meter functions continue to operate properly. Quick Programming Mode is configured in Module 3. The Display Intensity Level “d-LEu” parameter is available in the Quick Programming Mode only when the security code is non-zero. For a description, see Module 9—Factory Service Operations. Throughout this document, Programming Mode (without Quick in front) always refers to “Full” Programming Mode.

PROGRAMMING TIPS

The Programming Menu is organized into nine modules (See above). These modules group together parameters that are related in function. It is recommended to begin programming with Module 1 and proceed through each module in sequence. Note that Modules 6 through 8 are only accessible when the appropriate option card is installed. If lost or confused while programming, press the **DSP** key to exit programming mode and start over. When programming is complete, it is recommended to record the meter settings on the Parameter Value Chart and lock-out parameter programming with a User Input or lock-out code. (See Modules 2 and 3 for lock-out details.)

FACTORY SETTINGS

Factory Settings may be completely restored in Module 9. This is a good starting point if encountering programming problems. Throughout the module description sections which follow, the factory setting for each parameter is shown below the parameter display. In addition, all factory settings are listed on the Parameter Value Chart following the programming section.

ALTERNATING SELECTION DISPLAY

In the module description sections which follow, the dual display with arrows appears for each programming parameter. This is used to illustrate the display alternating between the parameter (top display) and the parameter's Factory Setting (bottom display). In most cases, selections or value ranges for the parameter will be listed on the right.

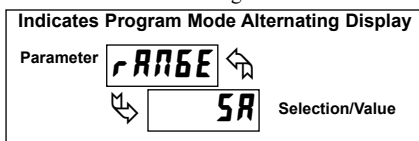

STEP BY STEP PROGRAMMING INSTRUCTIONS:

PROGRAMMING MODE ENTRY (PAR KEY)

The Programming Mode is entered by pressing the **PAR** key. If this mode is not accessible, then meter programming is locked by either a security code or a hardware lock. (See Modules 2 and 3 for programming lock-out details.)

MODULE ENTRY (ARROW & PAR KEYS)

Upon entering the Programming Mode, the display alternates between **Pr o** and the present module (initially **no**). The arrow keys (**F1▲** and **F2▼**) are used to select the desired module, which is then entered by pressing the **PAR** key.

PARAMETER (MODULE) MENU (PAR KEY)

Each module has a separate parameter menu. These menus are shown at the start of each module description section which follows. The **PAR** key is pressed to advance to a particular parameter to be changed, without changing the programming of preceding parameters. After completing a module, the display will return to **Pr o no**. From this point, programming may continue by selecting and entering additional modules. (See **MODULE ENTRY** above.)

PARAMETER SELECTION ENTRY (ARROW & PAR KEYS)

For each parameter, the display alternates between the parameter and the present selection or value for that parameter. For parameters which have a list of selections, the arrow keys (**F1▲** and **F2▼**) are used to sequence through the list until the desired selection is displayed. Pressing the **PAR** key stores and activates the displayed selection, and also advances the meter to the next parameter.

NUMERICAL VALUE ENTRY (ARROW, RST & PAR KEYS)

For parameters which require a numerical value entry, the arrow keys can be used to increment or decrement the display to the desired value. When an arrow key is pressed and held, the display automatically scrolls up or scrolls down. The longer the key is held, the faster the display scrolls.

The **RST** key can be used in combination with the arrow keys to enter large numerical values. When the **RST** key is pressed along with an arrow key, the display scrolls by 1000's. Pressing the **PAR** key stores and activates the displayed value, and also advances the meter to the next parameter.

PROGRAMMING MODE EXIT (DSP KEY or PAR KEY at Pr o no)

The Programming Mode is exited by pressing the **DSP** key (from anywhere in the Programming Mode) or the **PAR** key (with **Pr o no** displayed). This will commit any stored parameter changes to memory and return the meter to the Display Mode. If a parameter was just changed, the **PAR** key should be pressed to store the change before pressing the **DSP** key. (If power loss occurs before returning to the Display Mode, verify recent parameter changes.)

6.1 MODULE 1 - SIGNAL INPUT PARAMETERS (1-IMP)

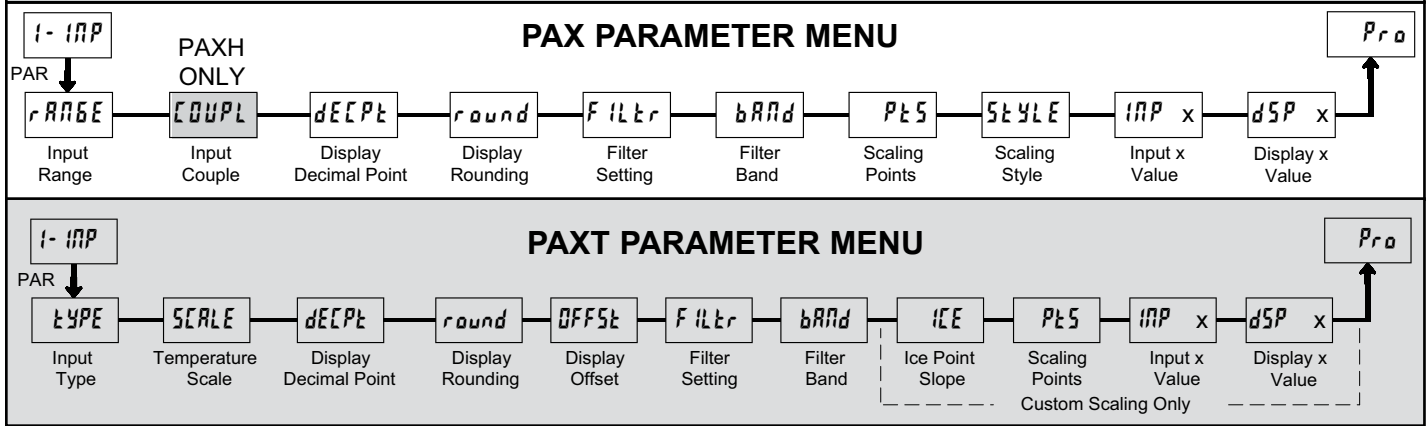

Refer to the appropriate Input Range for the selected meter. Use only one Input Range, then proceed to Display Decimal Point.

PAXD INPUT RANGE

SELECTION	RANGE	RESOLUTION	SELECTION	RANGE	RESOLUTION
300u	200uA	±200.00 µA	2u	±2.0000 V	
	0002A	±2.0000 mA	20u	±20.000 V	
	002A	±20.000 mA	300u	±300.00 V	
	02A	±200.00 mA	100o	100.00 ohm	
	2A	±2.0000 A	1000o	1000.0 ohm	
	02u	±200.00 mV	10Ko	10000 ohm	

Select the input range that corresponds to the external signal. This selection should be high enough to avoid input signal overload but low enough for the desired input resolution. This selection and the position of the Input Range Jumper must match.

PAXP INPUT RANGE

SELECTION	RANGE	RESOLUTION
002A	20.000 mA	
10u	10.000 V	

Select the input range that corresponds to the external signal.

PAXH INPUT RANGE

SELECTION	RANGE	RESOLUTION	SELECTION	RANGE	RESOLUTION
5A	02u	200.00 mV	0002A	2.0000 mA	
	2u	2.0000 V	002A	20.000 mA	
	20u	20.000 V	02A	200.00 mA	
	300u	300.0 V	5A	5.000 A	
	200uA	200.00 µA			

Select the input range that corresponds to the external signal. This selection should be high enough to avoid input signal overload but low enough for the desired input resolution. This selection and the position of the Input Range Jumper must match.

PAXH INPUT COUPLE

SELECTION	AC	or	DC
AC			

The input signal can be either AC coupled (rejecting the DC components of the signal) or DC coupled (measures both the AC and DC components of the signal). The coupling jumper and the setting of this parameter must match.

PAXS INPUT RANGE

SELECTION	RANGE	RESOLUTION
002u	±24 mV	
02u	±240 mV	

Select the input range that corresponds to the external signal. This selection should be high enough to avoid input signal overload but low enough for the desired input resolution. This selection and the position of the Input Range Jumper must match.

PAXT INPUT TYPE

SELECTION	TYPE	SELECTION	TYPE
tc-t	T TC	tc-c	C TC
tc-E	E TC	Pt385	RTD platinum 385
tc-J	J TC	Pt392	RTD platinum 392
tc-N	K TC	Ni672	RTD nickel 672
tc-r	R TC	Cu427	RTD copper 10 Ω
tc-S	S TC	CS-tc	Custom TC
tc-b	B TC	CS-rH	Custom RTD High
tc-n	N TC	CS-rL	Custom RTD Low

Select the input type that corresponds to the input sensor. For RTD types, check the RTD Input Jumper for matching selection. For custom types, the Temperature Scale parameter is not available, the Display Decimal Point is expanded, and Custom Sensor Scaling must be completed.

PAXT TEMPERATURE SCALE

SELECTION	°F	°C
°F		

Select the temperature scale. This selection applies for Input, MAX, MIN, and TOT displays. This does not change the user installed Custom Units Overlay display. If changed, those parameters that relate to the temperature scale should be checked. This selection is not available for custom sensor types.

DISPLAY DECIMAL POINT

SELECTION	0	00	000	0000	00000
0					

For the PAXT, these are only available with Custom Scaling.

Select the decimal point location for the Input, MAX and MIN displays. (The TOT display decimal point is a separate parameter.) This selection also affects round, dSP1 and dSP2 parameters and setpoint values.

DISPLAY ROUNDING

round 1

10 20 50 100

Bottom row selections are not available for the PAXT.

Rounding selections other than one, cause the Input Display to 'round' to the rounding increment selected (ie. rounding of '5' causes 121 to round to 120 and 124 to round to 125). Rounding starts at the least significant digit of the Input Display. Some parameter entries (setpoint values, etc.) may be adjusted to this display rounding selection.

PAXT: TEMPERATURE DISPLAY OFFSET

OFFSE 0

- 99999 to 99999

The temperature display can be corrected with an offset value. This can be used to compensate for probe errors, errors due to variances in probe placement or adjusting the readout to a reference thermometer. This value is automatically updated after a Zero Display to show how far the display is offset. A value of zero will remove the affects of offset.

FILTER SETTING

Filter 10

00 to 250 seconds

The input filter setting is a time constant expressed in tenths of a second. The filter settles to 99% of the final display value within approximately 3 time constants. This is an Adaptive Digital Filter which is designed to steady the Input Display reading. A value of '0' disables filtering.

FILTER BAND

band 10

00 to 250 display units

The digital filter will adapt to variations in the input signal. When the variation exceeds the input filter band value, the digital filter disengages. When the variation becomes less than the band value, the filter engages again. This allows for a stable readout, but permits the display to settle rapidly after a large process change. The value of the band is in display units. A band setting of '0' keeps the digital filter permanently engaged.

For the PAXT, the following parameters only apply to Custom Sensor Scaling.

PAXT: ICE POINT SLOPE

ICE 0.00

0 to 65000 $\mu\text{V}/^\circ\text{C}$

This parameter sets the slope value for ice point compensation for the Custom TC range (E5-E6) only. The fixed thermocouple ranges are automatically compensated by the meter and do not require this setting. To calculate this slope, use μV data obtained from thermocouple manufacturers' tables for two points between 0°C and 50°C . Place this corresponding μV and $^\circ\text{C}$ information into the equation:

$$\text{slope} = (\mu\text{V}_2 - \mu\text{V}_1) / (^\circ\text{C}_2 - ^\circ\text{C}_1)$$

Due to the nonlinear output of thermocouples, the compensation may show a small offset error at room temperatures. This can be compensated by the offset parameter. A value of 0 disables internal compensation when the thermocouple is externally compensated.

SCALING POINTS

Pt5 2

2 to 16

Linear - Scaling Points (2)

For linear processes, only 2 scaling points are necessary. It is recommended that the 2 scaling points be at opposite ends of the input signal being applied. The points do not have to be the signal limits. Display scaling will be linear between and continue past the entered points up to the limits of the Input Signal Jumper position. Each scaling point has a coordinate-pair of Input Value (*INP*) and an associated desired Display Value (*dSP*).

Nonlinear - Scaling Points (Greater than 2)

For non-linear processes, up to 16 scaling points may be used to provide a piece-wise linear approximation. (The greater the number of scaling points used, the greater the conformity accuracy.) The Input Display will be linear between scaling points that are sequential in program order. Each scaling point has a coordinate-pair of Input Value (*INP*) and an associated desired Display Value (*dSP*). Data from tables or equations, or empirical data could be used to derive the required number of segments and data values for the coordinate pairs. In the SFPAX software, several linearization equations are available.

SCALING STYLE

This parameter does not apply for the PAXT. Scaling values for the PAXT must be keyed-in.

STYLE KEY key-in data

APPLY apply signal

If Input Values and corresponding Display Values are known, the Key-in (*KEY*) scaling style can be used. This allows scaling without the presence or changing of the input signal. If Input Values have to be derived from the actual input signal source or simulator, the Apply (*APPLY*) scaling style must be used. After using the Apply (*APPLY*) scaling style, this parameter will default back to *KEY* but the scaling values will be shown from the previous applied method.

INPUT VALUE FOR SCALING POINT 1

INP 1 0.00

- 99999 to 99999

For Key-in (*KEY*), enter the known first Input Value by using the arrow keys. The Input Range selection sets up the decimal location for the Input Value. With 0.02A Input Range, 4mA would be entered as 4.000. For Apply (*APPLY*), apply the input signal to the meter, adjust the signal source externally until the desired Input Value appears. In either method, press the **PAR** key to enter the value being displayed.

Note: *APPLY* style - Pressing the **RST** key will advance the display to the next scaling display point without storing the input value.

DISPLAY VALUE FOR SCALING POINT 1

dSP 1 0.00

- 99999 to 99999

Enter the first coordinating Display Value by using the arrow keys. This is the same for *KEY* and *APPLY* scaling styles. The decimal point follows the **dECPt** selection.

INPUT VALUE FOR SCALING POINT 2

INP 2 100.00

- 99999 to 99999

For Key-in (*KEY*), enter the known second Input Value by using the arrow keys. For Apply (*APPLY*), adjust the signal source externally until the next desired Input Value appears. (Follow the same procedure if using more than 2 scaling points.)

DISPLAY VALUE FOR SCALING POINT 2

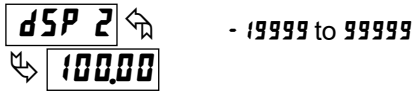

Enter the second coordinating Display Value by using the arrow keys. This is the same for **MEY** and **RPLY** scaling styles. (Follow the same procedure if using more than 2 scaling points.)

General Notes on Scaling

1. Input Values for scaling points should be confined to the limits of the Input Range Jumper position.
2. The same Input Value should not correspond to more than one Display Value. (Example: 20 mA can not equal 0 and 10.) This is referred to as read out jumps (vertical scaled segments).
3. The same Display Value can correspond to more than one Input Value. (Example: 0 mA and 20 mA can equal 10.) This is referred to as readout dead zones (horizontal scaled segments).

4. The maximum scaled Display Value spread between range maximum and minimum is limited to 65,535. For example using +20 mA range the maximum +20 mA can be scaled to is 32,767 with 0 mA being 0 and Display Rounding of 1. (Decimal points are ignored.) The other half of 65,535 is for the lower half of the range 0 to -20 mA even if it is not used. With Display Rounding of 2, +20 mA can be scaled for 65,535 (32,767 x 2) but with even Input Display values shown.
5. For input levels beyond the first programmed Input Value, the meter extends the Display Value by calculating the slope from the first two coordinate pairs ($INP1 / dSP1$ & $INP2 / dSP2$). If $INP1 = 4$ mA and $dSP1 = 0$, then 0 mA would be some negative Display Value. This could be prevented by making $INP1 = 0$ mA / $dSP1 = 0$, $INP2 = 4$ mA / $dSP2 = 0$, with $INP3 = 20$ mA / $dSP3 =$ the desired high Display Value. The calculations stop at the limits of the Input Range Jumper position.
6. For input levels beyond the last programmed Input Value, the meter extends the Display Value by calculating the slope from the last two sequential coordinate pairs. If three coordinate pair scaling points were entered, then the Display Value calculation would be between $INP2 / dSP2$ & $INP3 / dSP3$. The calculations stop at the limits of the Input Range Jumper position.

6.2 MODULE 2 - USER INPUT AND FRONT PANEL FUNCTION KEY PARAMETERS (2-FNC)

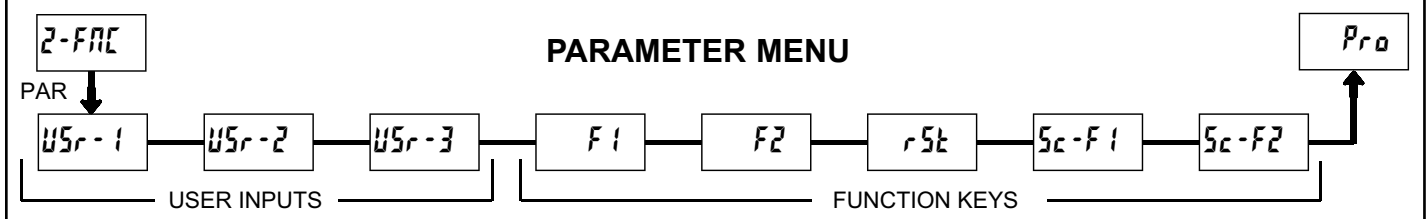

The three user inputs are individually programmable to perform specific meter control functions. While in the Display Mode or Program Mode, the function is executed the instant the user input transitions to the active state.

The front panel function keys are also individually programmable to perform specific meter control functions. While in the Display Mode, the primary function is executed the instant the key is pressed. Holding the function key for three seconds executes a secondary function. It is possible to program a secondary function without a primary function.

In most cases, if more than one user input and/or function key is programmed for the same function, the maintained (level trigger) actions will be performed while at least one of those user inputs or function keys are activated. The momentary (edge trigger) actions will be performed every time any of those user inputs or function keys transition to the active state.

Note: In the following explanations, not all selections are available for both user inputs and front panel function keys. Alternating displays are shown with each selection. Those selections showing both displays are available for both. If a display is not shown, it is not available for that selection. **USR-1** will represent all three user inputs. **F1** will represent all five function keys.

ZERO (TARE) DISPLAY



The Zero (Tare) Display provides a way to zero the Input Display value at various input levels, causing future Display readings to be offset. This function is useful in weighing applications where the container or material on the scale should not be included in the next measurement value. When activated (momentary action), **rESEt** flashes and the Display is set to zero. At the same time, the Display value (that was on the display before the Zero Display) is subtracted from the Display Offset Value and is automatically stored as the new Display Offset Value (**OFFSt**). If another Zero (tare) Display is performed, the display will again change to zero and the Display reading will shift accordingly.

NO FUNCTION



No function is performed if activated. This is the factory setting for all user inputs and function keys. No function can be selected without affecting basic start-up.

RELATIVE/ABSOLUTE DISPLAY



This function will switch the Input Display between Relative and Absolute. The Relative is a net value that includes the Display Offset Value. The Input Display will normally show the Relative unless switched by this function. Regardless of the display selected, all meter functions continue to operate based on relative values. The Absolute is a gross value (based on Module 1 **DSP** and **INP** entries) without the Display Offset Value. The Absolute display is selected as long as the user input is activated (maintained action) or at the transition of the function key (momentary action). When the user input is released, or the function key is pressed again, the input display switches back to Relative display. **AbS** (absolute) or **rEL** (relative) is momentarily displayed at transition to indicate which display is active.

PROGRAMMING MODE LOCK-OUT

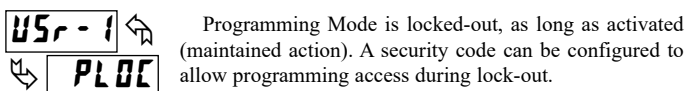

Programming Mode is locked-out, as long as activated (maintained action). A security code can be configured to allow programming access during lock-out.

HOLD DISPLAY

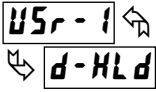

The shown display is held but all other meter functions continue as long as activated (maintained action).

HOLD ALL FUNCTIONS

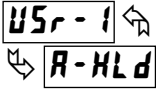

The meter disables processing the input, holds all display contents, and locks the state of all outputs as long as activated (maintained action). The serial port continues data transfer.

SYNCHRONIZE METER READING

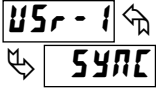

The meter suspends all functions as long as activated (maintained action). When the user input is released, the meter synchronizes the restart of the A/D with other processes or timing events.

STORE BATCH READING IN TOTALIZER



The Input Display value is one time added (batched) to the Totalizer at transition to activate (momentary action). The Totalizer retains a running sum of each batch operation until the Totalizer is reset. When this function is selected, the normal operation of the Totalizer is overridden.

SELECT TOTALIZER DISPLAY

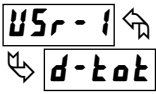

The Totalizer display is selected as long as activated (maintained action). When the user input is released, the Input Display is returned. The DSP key overrides the active user input. The Totalizer continues to function including associated outputs independent of being displayed.

RESET TOTALIZER



When activated (momentary action), rESEt flashes and the Totalizer resets to zero. The Totalizer then continues to operate as it is configured. This selection functions independent of the selected display.

RESET AND ENABLE TOTALIZER

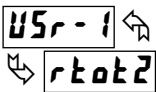

When activated (momentary action), rESEt flashes and the Totalizer resets to zero. The Totalizer continues to operate while active (maintained action). When the user input is released, the Totalizer stops and holds its value. This selection functions independent of the selected display.

ENABLE TOTALIZER

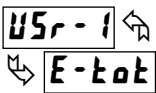

The Totalizer continues to operate as long as activated (maintained action). When the user input is released, the Totalizer stops and holds its value. This selection functions independent of the selected display.

SELECT MAXIMUM DISPLAY

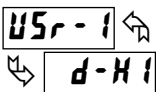

The Maximum display is selected as long as activated (maintained action). When the user input is released, the Input Display returns. The DSP key overrides the active user input. The Maximum continues to function independent of being displayed.

RESET MAXIMUM

When activated (momentary action), rESEt flashes and the Maximum resets to the present Input Display value. The Maximum function then continues from that value. This selection functions independent of the selected display.

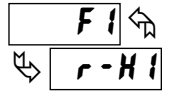

RESET, SELECT, ENABLE MAXIMUM DISPLAY

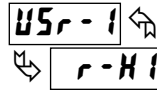

When activated (momentary action), the Maximum value is set to the present Input Display value. Maximum continues from that value while active (maintained action). When the user input is released, Maximum detection stops and holds its value. This selection functions independent of the selected display. The DSP key overrides the active user input display but not the Maximum function.

SELECT MINIMUM DISPLAY

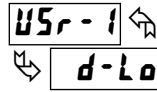

The Minimum display is selected as long as activated (maintained action). When the user input is released, the Input Display is returned. The DSP key overrides the active user input. The Minimum continues to function independent of being displayed.

RESET MINIMUM

When activated (momentary action), rESEt flashes and the Minimum reading is set to the present Input Display value. The Minimum function then continues from that value. This selection functions independent of the selected display.

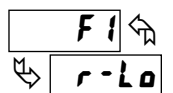

RESET, SELECT, ENABLE MINIMUM DISPLAY

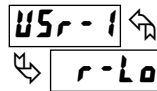

When activated (momentary action), the Minimum value is set to the present Input Display value. Minimum continues from that value while active (maintained action). When the user input is released, Minimum detection stops and holds its value. This selection functions independent of the selected display. The DSP key overrides the active user input display but not the Minimum function.

RESET MAXIMUM AND MINIMUM

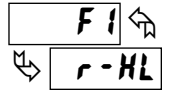
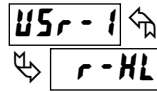

When activated (momentary action), rESEt flashes and the Maximum and Minimum readings are set to the present Input Display value. The Maximum and Minimum function then continues from that value. This selection functions independent of the selected display.

CHANGE DISPLAY INTENSITY LEVEL

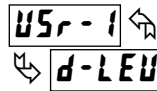

When activated (momentary action), the display intensity changes to the next intensity level (of 4). The four levels correspond to Display Intensity Level (d-LEu) settings of 0, 3, 8, and 15. The intensity level, when changed via the User Input/ Function Key, is not retained at power-down, unless Quick Programming or Full Programming mode is entered and exited. The meter will power-up at the last saved intensity level.

SETPOINT SELECTIONS

The following selections are accessible only with the Setpoint option card installed. Refer to Module 6 for an explanation of their operation.

Setpoint Card Only	}	L15t - Select main or alternate setpoints
		r-1 - Reset Setpoint 1 (Alarm 1)
		r-2 - Reset Setpoint 2 (Alarm 2)
		r-3 - Reset Setpoint 3 (Alarm 3)
		r-4 - Reset Setpoint 4 (Alarm 4)
		r-34 - Reset Setpoint 3 & 4 (Alarm 3 & 4)
		r-234 - Reset Setpoint 2, 3 & 4 (Alarm 2, 3 & 4)
r-RLl - Reset Setpoint All (Alarm All)		

PRINT REQUEST

USr-1
Print

Fl
Print

The meter issues a block print through the serial port when activated. The data transmitted during a print request is programmed in Module 7. If the user input is still active after the transmission is complete (about 100 msec), an additional transmission occurs. As long as the user input is held active, continuous transmissions occur.

6.3 MODULE 3 - DISPLAY AND PROGRAM LOCK-OUT PARAMETERS (3-LOC)

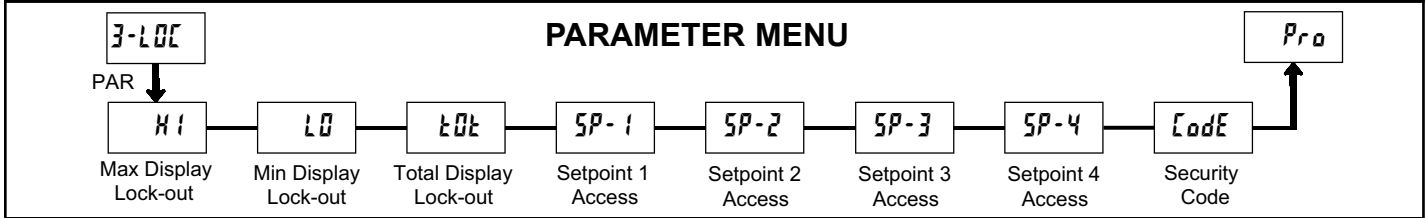

Module 3 is the programming for Display lock-out and “Full” and “Quick” Program lock-out.

When in the Display Mode, the available displays can be read consecutively by repeatedly pressing the **DSP** key. An annunciator indicates the display being shown. These displays can be locked from being visible. It is recommended that the display be set to **L0t** when the corresponding function is not used.

SELECTION	DESCRIPTION
rEd	Visible in Display Mode
L0t	Not visible in Display Mode

“Full” Programming Mode permits all parameters to be viewed and modified. This Programming Mode can be locked with a security code and/or user input. When locked and the **PAR** key is pressed, the meter enters a Quick Programming Mode. In this mode, the setpoint values can still be read and/or changed per the selections below. The Display Intensity Level (**d-LEU**) parameter also appears whenever Quick Programming Mode is enabled and the security code is greater than zero.

SELECTION	DESCRIPTION
rEd	Visible but not changeable in Quick Programming Mode
ERt	Visible and changeable in Quick Programming Mode
L0t	Not visible in Quick Programming Mode

MAXIMUM DISPLAY LOCK-OUT MINIMUM DISPLAY LOCK-OUT TOTALIZER DISPLAY LOCK-OUT

H1
LO
L0t
LOC

These displays can be programmed for **L0t** or **rEd**. When programmed for **L0t**, the display will not be shown when the **DSP** key is pressed regardless of Program Lock-out status. It is suggested to lock-out the display if it is not needed. The associated function will continue to operate even if its display is locked-out.

SP-1 SP-2 SP-3 SP-4 SETPOINT ACCESS*

SP-1
SP-2
SP-3
SP-4
LOC

The setpoint displays can be programmed for **L0t**, **rEd** or **ERt** (See the following table). Accessible only with the Setpoint option card installed.

PROGRAM MODE SECURITY CODE

Code 0 to 250

By entering any non-zero value, the prompt **Code 0** will appear when trying to access the Program Mode. Access will only be allowed after entering a matching security code or universal code of **222**. With this lock-out, a user input would not have to be configured for Program Lock-out. However, this lock-out is overridden by an inactive user input configured for Program Lock-out.

PROGRAMMING MODE ACCESS

SECURITY CODE	USER INPUT CONFIGURED	USER INPUT STATE	WHEN PAR KEY IS PRESSED	“FULL” PROGRAMMING MODE ACCESS
0	not PL0t	————	“Full” Programming	Immediate access.
>0	not PL0t	————	Quick Programming w/Display Intensity	After Quick Programming with correct code # at Code prompt.
>0	PL0t	Active	Quick Programming w/Display Intensity	After Quick Programming with correct code # at Code prompt.
>0	PL0t	Not Active	“Full” Programming	Immediate access.
0	PL0t	Active	Quick Programming	No access
0	PL0t	Not Active	“Full” Programming	Immediate access.

Throughout this document, Programming Mode (without Quick in front) always refers to “Full” Programming (all meter parameters are accessible).

6.4 MODULE 4 - SECONDARY FUNCTION PARAMETERS (4-5EE)

PARAMETER MENU

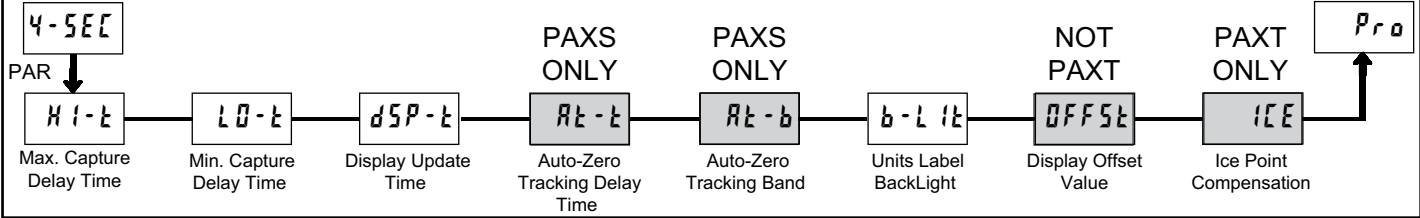

MAX CAPTURE DELAY TIME

0.0 to 3275.0 sec.

When the Input Display is above the present MAX value for the entered delay time, the meter will capture that display value as the new MAX reading. A delay time helps to avoid false captures of sudden short spikes.

MIN CAPTURE DELAY TIME

0.0 to 3275.0 sec.

When the Input Display is below the present MIN value for the entered delay time, the meter will capture that display value as the new MIN reading. A delay time helps to avoid false captures of sudden short spikes.

DISPLAY UPDATE RATE

1 2 5 10 20 updates/sec.

This parameter determines the rate of display update. When set to 20 updates/second, the internal re-zero compensation is disabled, allowing for the fastest possible output response.

PAXS: AUTO-ZERO TRACKING

0 to 250 sec.

PAXS: AUTO-ZERO BAND

1 to 4095

The meter can be programmed to automatically compensate for zero drift. Drift may be caused by changes in the transducers or electronics, or accumulation of material on weight systems.

Auto-zero tracking operates when the readout remains within the tracking band for a period of time equal to the tracking delay time. When these conditions are met, the meter re-zeroes the readout. After the re-zero operation, the meter resets and continues to auto-zero track.

The auto-zero tracking band should be set large enough to track normal zero drift, but small enough to not interfere with small process inputs. The resolution of the band value will be affected by the input rounding factor (*i-IMP, round*).

For filling operations, the fill rate must exceed the auto-zero tracking rate. This avoids false tracking at the start of the filling operation.

$$\text{Fill Rate} \geq \frac{\text{tracking band}}{\text{tracking time}}$$

Auto-zero tracking is disabled and internally reset by setting the auto-zero tracking parameter = 0.

UNITS LABEL BACKLIGHT

ON OFF

The Units Label Kit Accessory contains a sheet of custom unit overlays which can be installed in to the meter's bezel display assembly. The backlight for these custom units is activated by this parameter.

DISPLAY OFFSET VALUE

This parameter does not apply for the PAXT.

- 19999 to 19999

Unless a Zero Display was performed or an offset from Module 1 scaling is desired, this parameter can be skipped. The Display Offset Value is the difference from the Absolute (gross) Display value to the Relative (net) Display value for the same input level. The meter will automatically update this Display Offset Value after each Zero Display. The Display Offset Value can be directly keyed-in to intentionally add or remove display offset. See Relative / Absolute Display and Zero Display explanations in Module 2.

PAXT: ICE POINT COMPENSATION

ON OFF

This parameter turns the internal ice point compensation on or off. Normally, the ice point compensation is on. If using external compensation, set this parameter to off. In this case, use copper leads from the external compensation point to the meter. If using Custom TC range, the ice point compensation can be adjusted by a value in Module 1 when this is yes.

6.5 MODULE 5 - TOTALIZER (INTEGRATOR) PARAMETERS (5-101)

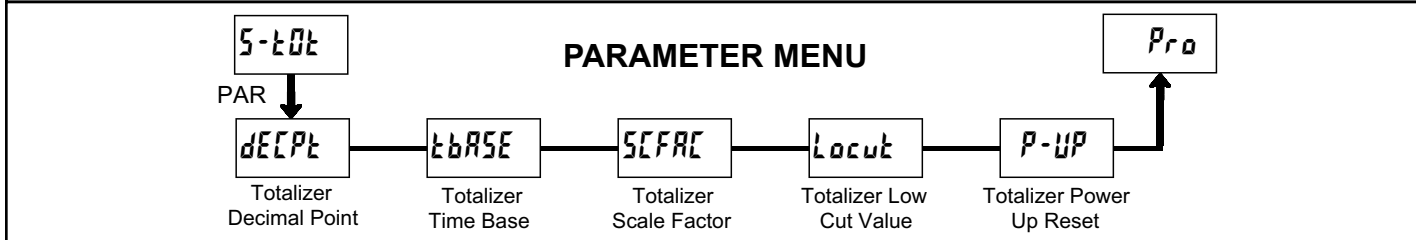

The totalizer accumulates (integrates) the Input Display value using one of two modes. The first is using a time base. This can be used to compute a time-temperature product. The second is through a user input or function key programmed for Batch (one time add on demand). This can be used to provide a readout of temperature integration, useful in curing and sterilization applications. If the Totalizer is not needed, its display can be locked-out and this module can be skipped during programming.

TOTALIZER DECIMAL POINT



For most applications, this matches the Input Display Decimal Point (dECPt). If a different location is desired, refer to Totalizer Scale Factor.

TOTALIZER TIME BASE

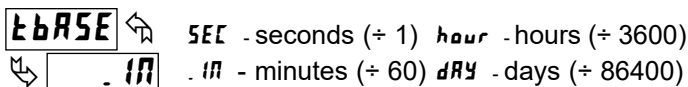

This is the time base used in Totalizer accumulations. If the Totalizer is being accumulated through a user input programmed for Batch, then this parameter does not apply.

TOTALIZER SCALE FACTOR



For most applications, the Totalizer reflects the same decimal point location and engineering units as the Input Display. In these cases, the Totalizer Scale Factor is 1.000. The Totalizer Scale Factor can be used to scale the Totalizer to a different value than the Input Display. Common possibilities are:

1. Changing decimal point location (example tenths to whole)
2. Average over a controlled time frame.

Details on calculating the scale factor are shown later.

If the Totalizer is being accumulated through a user input programmed for Batch, then this parameter does not apply.

TOTALIZER LOW CUT VALUE

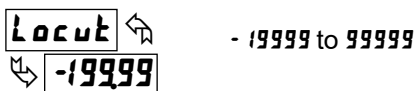

A low cut value disables Totalizer when the Input Display value falls below the value programmed.

The resolution of this parameter will be affected by the input rounding factor (i-IMP, round).

TOTALIZER POWER UP RESET

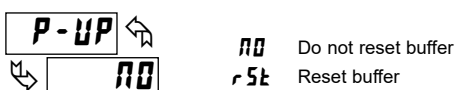

The Totalizer can be reset to zero on each meter power-up by setting this parameter to reset.

TOTALIZER HIGH ORDER DISPLAY

When the total exceeds 5 digits, the front panel annunciator TOT flashes. In this case, the meter continues to totalize up to a 9 digit value. The high order 4 digits and the low order 5 digits of the total are displayed alternately. The letter "h" denotes the high order display. When the total exceeds a 9 digit value, the Totalizer will show "E . . ." and will stop.

TOTALIZER BATCHING

The Totalizer Time Base and scale factor are overridden when a user input or function key is programmed for store batch (bAt). In this mode, when the user input or function key is activated, the Input Display reading is one time added to the Totalizer (batch). The Totalizer retains a running sum of each batch operation until the Totalizer is reset. This is useful in weighing operations, when the value to be added is not based on time but after a filling event.

TOTALIZER USING TIME BASE

Totalizer accumulates as defined by:

$$\frac{\text{Input Display} \times \text{Totalizer Scale Factor}}{\text{Totalizer Time Base}}$$

Where:

- Input Display - the present input reading
- Totalizer Scale Factor - 0.001 to 65.000
- Totalizer Time Base - (the division factor of tBASE)

Example: The input reading is at a constant rate of 10.0 gallons per minute. The Totalizer is used to determine how many gallons in tenths has flowed. Because the Input Display and Totalizer are both in tenths of gallons, the Totalizer Scale Factor is 1. With gallons per minute, the Totalizer Time Base is minutes (60). By placing these values in the equation, the Totalizer will accumulate every second as follows:

$$\frac{10.0 \times 1.000}{60} = 0.1667 \text{ gallon accumulates each second}$$

This results in:

- 10.0 gallons accumulates each minute
- 600.0 gallons accumulates each hour

TOTALIZER SCALE FACTOR CALCULATION EXAMPLES

1. When changing the Totalizer Decimal Point (dECPt) location from the Input Display Decimal Point (dECPt), the required Totalizer Scale Factor is multiplied by a power of ten.

Example:

Input (dECPt) = 0 Input (dECPt) = 0.0 Input (dECPt) = 0.00

Totalizer dECPt	Scale Factor
0.0	10
0	1
x10	0.1
x100	0.01
x1000	0.001

Totalizer dECPt	Scale Factor
0.00	10
0.0	1
0	0.1
x10	0.01
x100	0.001

Totalizer dECPt	Scale Factor
0.000	10
0.00	1
0.0	0.1
0	0.01
x10	0.001

(x = Totalizer display is round by tens or hundreds)

2. To obtain an average reading within a controlled time frame, the selected Totalizer Time Base is divided by the given time period expressed in the same timing units.

Example: Average temperature per hour in a 4 hour period, the scale factor would be 0.250. To achieve a controlled time frame, connect an external timer to a user input programmed for rAt. The timer will control the start (reset) and the stopping (hold) of the totalizer.

6.6 MODULE 6 - SETPOINT (ALARM) PARAMETERS (δ-SPt) ▽

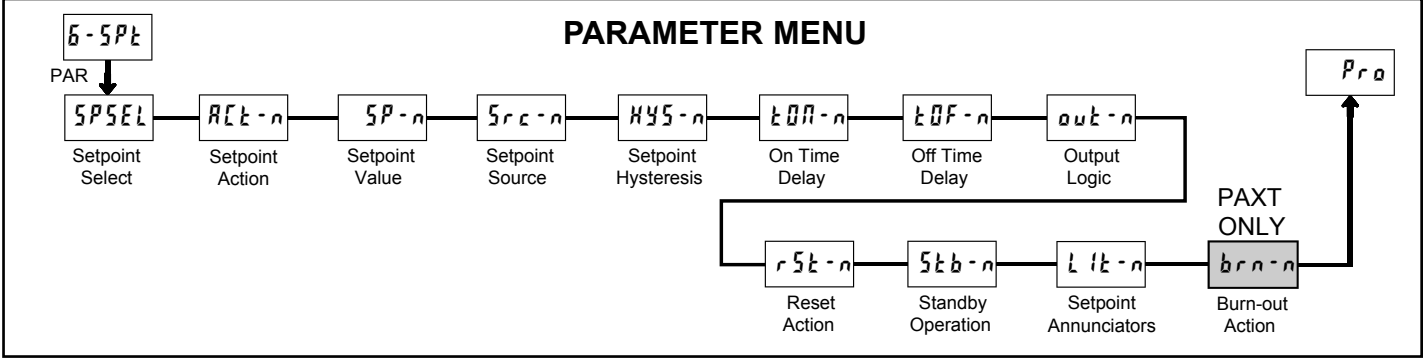

▽ - A setpoint card must be installed in order to access this module.

Depending on the card installed, there will be two or four setpoint outputs available. For maximum input frequency, unused Setpoints should be configured for **OFF** action.

The setpoint assignment and the setpoint action determine certain setpoint feature availability.

SETPOINT SELECT



Enter the setpoint (alarm output) to be programmed. The **n** in the following parameters will reflect the chosen setpoint number. After the chosen setpoint is completely programmed, the display will return to **SPSEL n0**. Repeat step for each setpoint to be programmed. The **n0** chosen at **SPSEL** will return to **Prd n0**. The number of setpoints available is setpoint output card dependent.

Setpoint Alarm Figures

With reverse output logic **rEu**, the below alarm states are opposite.

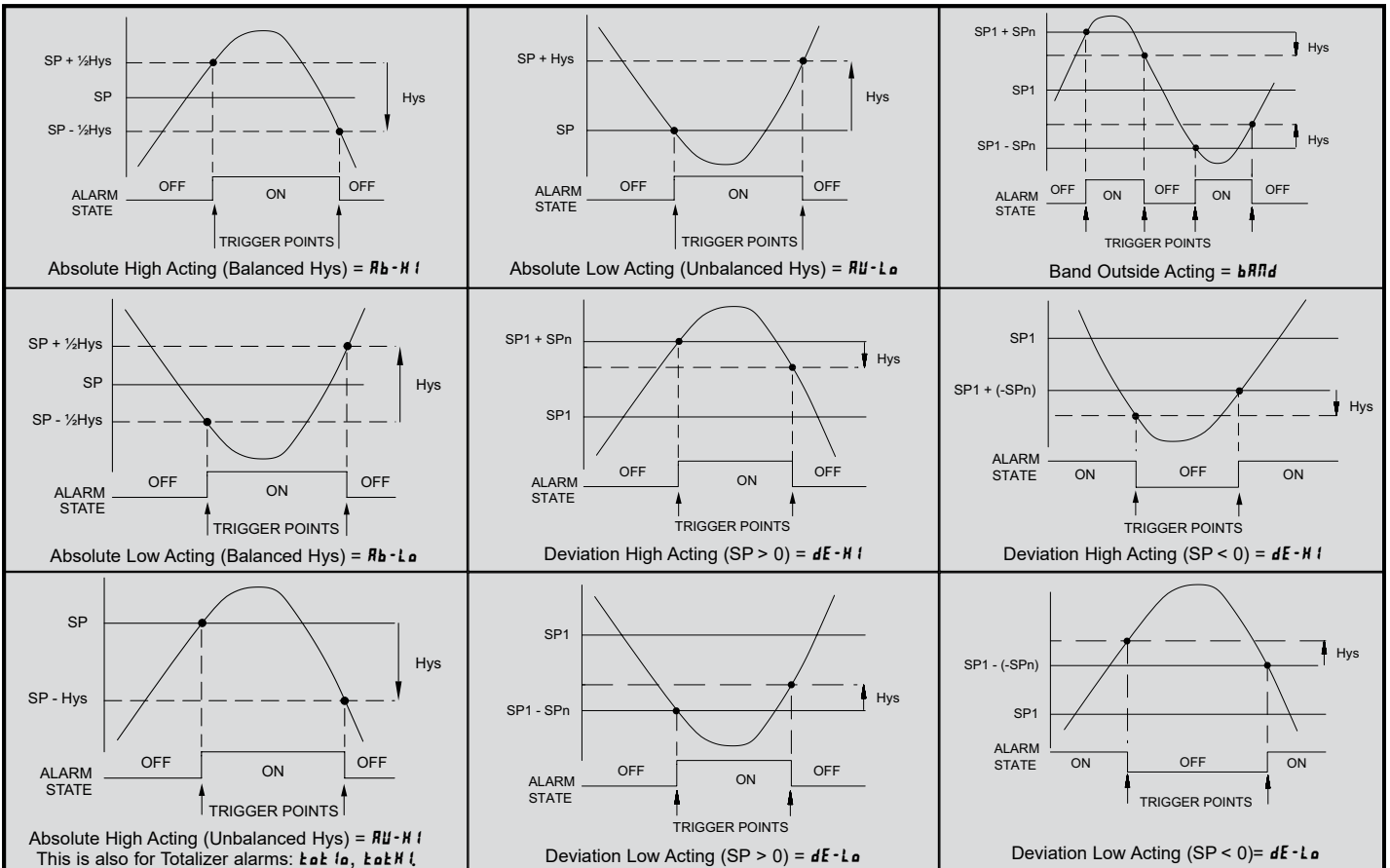

SETPOINT ACTION

Act-n OFF **Rb-HI** **Rb-LO** **RU-HI** **RU-LO**
OFF **dE-HI** **dE-LO** **bRRd** **totLo** **totHI**

Enter the action for the selected setpoint (alarm output). See Setpoint Alarm Figures for a visual detail of each action.

- OFF** = Setpoint always off, (returns to SPSEL NO)
- Rb-HI** = Absolute high, with balanced hysteresis
- Rb-LO** = Absolute low, with balanced hysteresis
- RU-HI** = Absolute high, with unbalanced hysteresis
- RU-LO** = Absolute low, with unbalanced hysteresis
- dE-HI** = Deviation high, with unbalanced hysteresis *
- dE-LO** = Deviation low, with unbalanced hysteresis *
- bRRd** = Outside band, with unbalanced hysteresis *
- totLo** = Lower Totalizer absolute high, unbalance hysteresis**
- totHI** = Upper Totalizer absolute high, unbalance hysteresis**

* Deviation and band action setpoints are relative to the value of setpoint 1. It is not possible to configure setpoint 1 as deviation or band actions. It is possible to use setpoint 1 for an absolute action, while its value is being used for deviation or band.

** The lower Totalizer action **totLo** allows setpoints to function off of the lower 5 digits of the Totalizer. The upper Totalizer action **totHI** allows setpoints to function off of the upper 4 digits of the Totalizer. To obtain absolute low alarms for the Totalizer, program the **totLo** or **totHI** output logic as reverse.

SETPOINT VALUE

SP-n - 99999 to 99999
 10.00

Enter desired setpoint alarm value. These setpoint values can also be entered in the Display Mode during Program Lock-out when the setpoint is programmed as **Ent** in Parameter Module 3. Depending on the Setpoint Action, **Act-n**, the value may be affected by the input rounding factor, **INP round**. When a setpoint is programmed as deviation or band acting, the associated output tracks **SP1** as it is changed. The value entered is the offset, or difference from **SP1**.

SETPOINT SOURCE

Src-n **rEL** **RbS**
rEL

Selects the meter input value to be used to trigger the Setpoint Alarm. The **rEL** setting will cause the setpoint to trigger off of the relative (net) input value. The relative input value is the absolute input value that includes the Display Offset Value. The **RbS** setting will cause the setpoint to trigger off of the absolute (gross) input value. The absolute input value is based on Module 1 **dISPLy** and **INPUt** entries. This parameter is not available when **Act-n** is **totLo** or **totHI**.

HYSTERESIS VALUE

HYS-n 1 to 65000
 0.02

Enter desired hysteresis value. See Setpoint Alarm Figures for visual explanation of how setpoint alarm actions (balance and unbalance) are affected by the hysteresis. Depending on the Setpoint Action, **Act-n**, the value may be affected by the input rounding factor, **INP round**. When the setpoint is a control output, usually balance hysteresis is used. For alarm applications, usually unbalanced hysteresis is used. For unbalanced hysteresis modes, the hysteresis functions on the low side for high acting setpoints and functions on the high side for low acting setpoints.

Note: Hysteresis eliminates output chatter at the switch point, while time delay can be used to prevent false triggering during process transient events.

ON TIME DELAY

TON-n 0.0 to 32750 sec.
 0.0

Enter the time value in seconds that the alarm is delayed from turning on after the trigger point is reached. A value of 0.0 allows the meter to update the alarm status per the response time listed in the Specifications. When the output logic is **rEu**, this becomes off time delay. Any time accumulated at power-off resets during power-up.

OFF TIME DELAY

TOF-n 0.0 to 32750 sec.
 0.0

Enter the time value in seconds that the alarm is delayed from turning off after the trigger point is reached. A value of 0.0 allows the meter to update the alarm status per the response time listed in the Specifications. When the output logic is **rEu**, this becomes on time delay. Any time accumulated at power-off resets during power-up.

OUTPUT LOGIC

out-n **nor** **rEu**
nor

Enter the output logic of the alarm output. The **nor** logic leaves the output operation as normal. The **rEu** logic reverses the output logic. In **rEu**, the alarm states in the Setpoint Alarm Figures are reversed.

RESET ACTION

rSt-n **Ruto** **LREt1** **LREt2**
Ruto

Enter the reset action of the alarm output.

Ruto = Automatic action; This action allows the alarm output to automatically reset off at the trigger points per the Setpoint Action shown in Setpoint Alarm Figures. The “on” alarm may be manually reset (off) immediately by a front panel function key or user input. The alarm remains reset off until the trigger point is crossed again.

LREt1 = Latch with immediate reset action; This action latches the alarm output on at the trigger point per the Setpoint Action shown in Setpoint Alarm Figures. Latch means that the alarm output can only be turned off by front panel function key or user input manual reset, serial reset command or meter power cycle. When the user input or function key is activated (momentary or maintained), the corresponding “on” alarm output is reset immediately and remains off until the trigger point is crossed again. (Previously latched alarms will be off if power up Display Value is lower than setpoint value.)

LREt2 = Latch with delay reset action; This action latches the alarm output on at the trigger point per the Setpoint Action shown in Setpoint Alarm Figures. Latch means that the alarm output can only be turned off by front panel function key or user input manual reset, serial reset command or meter power cycle. When the user input or function key is activated (momentary or maintained), the meter delays the event until the corresponding “on” alarm output crosses the trigger off point. (Previously latched alarms are off if power up Display Value is lower than setpoint value. During a power cycle, the meter erases a previous Latch 2 reset if it is not activated at power up.)

STANDBY OPERATION

Stb-n **no** **YES**
no

When **YES**, the alarm is disabled (after a power up) until the trigger point is crossed. Once the alarm is on, the alarm operates normally per the Setpoint Action and Reset Mode.

SETPOINT ANNUNCIATORS

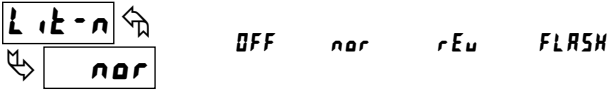

The **OFF** mode disables display setpoint annunciators. The **nor** mode displays the corresponding setpoint annunciators of “on” alarm outputs. The **rEu** mode displays the corresponding setpoint annunciators of “off” alarms outputs. The **FLASH** mode flashes the corresponding setpoint annunciators of “on” alarm outputs.

PROBE BURN-OUT ACTION (PAXT ONLY)

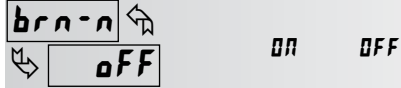

Enter the probe burn-out action. In the event of a temperature probe failure, the alarm output can be programmed to go on or off.

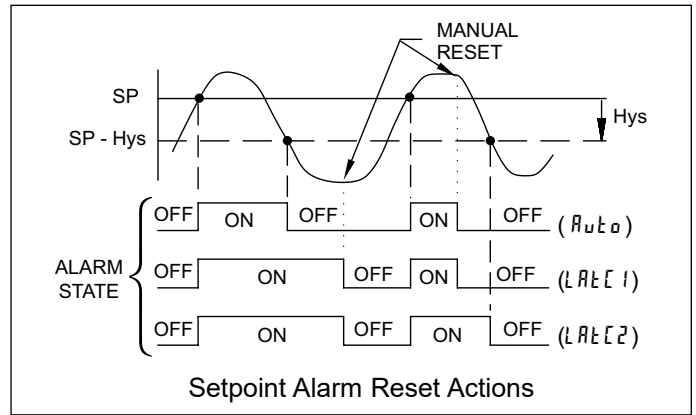

Alternate Setpoints

An Alternate list of setpoint values can be stored and recalled as needed. The Alternate list allows an additional set of setpoint values. (The setpoint numbers nor rear terminal numbers will change in the Alternate list.) The Alternate list can only be activated through a function key or user input programmed for **L 15t** in Module 2. When the Alternate list is selected, the Main list is stored and becomes inactive. When changing between Main and Alternate, the alarm state of Auto Reset Action alarms will always follow their new value. Latched “on” alarms will always stay latched during the transition and can only be reset with a user input or function key. Only during the function key or user input transition does the display indicate which list is being used.

6.7 MODULE 7 - SERIAL COMMUNICATIONS PARAMETERS (7-5rL) ▽

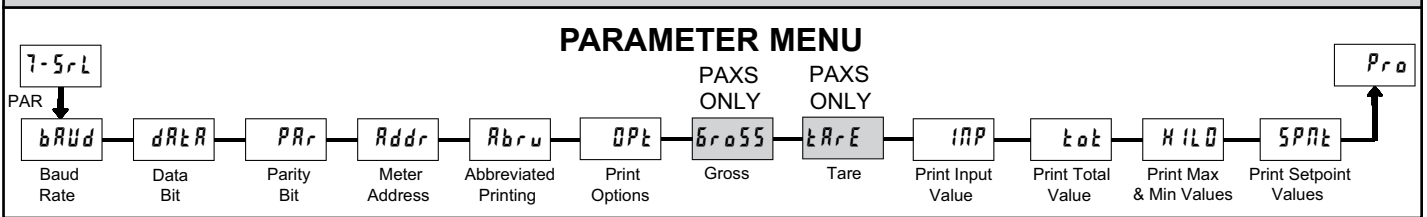

▽ - A communication card must be installed in order to access this module.

BAUD RATE

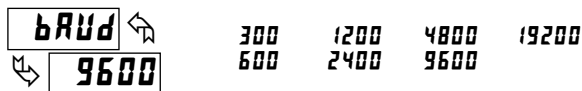

Set the baud rate to match that of other serial communications equipment. Normally, the baud rate is set to the highest value that all of the serial communications equipment is capable of transmitting.

DATA BIT



Select either 7 or 8 bit data word lengths. Set the word length to match that of other serial communication equipment. Since the meter receives and transmits 7-bit ASCII encoded data, 7 bit word length is sufficient to request and receive data from the meter.

PARITY BIT



Set the parity bit to match that of the other serial communications equipment used. The meter ignores the parity when receiving data, and sets the parity bit for outgoing data. If no parity is selected with 7-bit word length the meter transmits and receives data with 2 stop bits. (For example: 10 bit frame with mark parity)

METER ADDRESS



Enter the serial node address. With a single unit on a bus, an address is not needed and a value of zero can be used (RS232 applications). Otherwise, with multiple bussed units, a unique address number must be assigned to each meter. The node address applies specifically to RS485 applications.

ABBREVIATED PRINTING

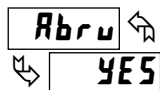

YES NO

Select abbreviated transmissions (numeric only) or full field transmission. When the data from the meter is sent directly to a terminal for display, the extra characters that are sent identify the nature of the meter parameter displayed. In this case, select **NO**. When the data from the meter goes to a computer, it may be desirable to suppress the node address and mnemonic when transmitting. In this case, set this parameter to **YES**.

PRINT OPTIONS



YES NO

YES - Enters the sub-menu to select those meter parameters to appear in the block print. For each parameter in the sub-menu select **YES** for the parameter to appear with the block print, and **NO** to disable the parameter.

Gross Value (PAXS Only)	GrpSS	YES	NO
Tare Value (PAXS Only)	tArE	YES	NO
Input Value	INP	YES	NO
Max and Min Values	h iLd	YES	NO
Total Value	tAt	YES	NO
Setpoint values*	SPnt	YES	NO

*Setpoints 1-4 are setpoint option card dependent.

Sending Commands and Data

When sending commands to the meter, a string containing at least one command character must be constructed. A command string consists of a command character, a value identifier, numerical data (if writing data to the meter) followed by a the command terminator character * or \$.

Command Chart

Command	Description	Notes
N	Node Address Specifier	Address a specific meter. Must be followed by one or two digit node address. Not required when node address = 0.
T	Transmit Value (read)	Read a register from the meter. Must be followed by register ID character.
V	Value change (write)	Write to register of the meter. Must be followed by register ID character and numeric data.
R	Reset	Reset a register or output. Must be followed by register ID character
P	Block Print Request (read)	Initiates a block print output. Registers are defined in programming.

Command String Construction

The command string must be constructed in a specific sequence. The meter does not respond with an error message to illegal commands. The following procedure details construction of a command string:

- The first 2 or 3 characters consist of the Node Address Specifier (N) followed by a 1 or 2 character node address number. The node address number of the meter is programmable. If the node address is 0, this command and the node address itself may be omitted. This is the only command that may be used in conjunction with other commands.
- After the optional address specifier, the next character is the command character.
- The next character is the register ID. This identifies the register that the command affects. The P command does not require a register ID character. It prints according to the selections made in print options.
- If constructing a value change command (writing data), the numeric data is sent next.
- All command strings must be terminated with the string termination characters * or \$. The meter does not begin processing the command string until this character is received. See timing diagram figure for differences of * and \$ terminating characters.

Register Identification Chart

ID	Value Description	Register ID	Applicable Commands/Comments
A	Input	INP	T, P, R (Reset command [Ver2.5+] zeros the input ["REL" or Tare])
B	Total	TOT	T, P, R (Reset command resets total to zero)
C	Max Input	MAX	T, P, R (Reset command resets MAX to current reading)
D	Min Input	MIN	T, P, R (Reset command resets MIN to current reading)
E	Setpoint 1	SP1	T, P, V, R (Reset command resets the setpoint output)
F	Setpoint 2	SP2	T, P, V, R (Reset command resets the setpoint output)
G	Setpoint 3	SP3	T, P, V, R (Reset command resets the setpoint output)
H	Setpoint 4	SP4	T, P, V, R (Reset command resets the setpoint output)
I	Analog Output Register	AOR	T, V (Applies to manual mode)
J	Control Status Register	CSR	T, V
L	Absolute (gross) input display value	ABS GRS †	T, P
Q	Offset/Tare (PAXS)	OFS TAR †	T, P, V (Ver 2.5+)

† -Register ID for the PAXS.

Command String Examples:

- Node address = 17, Write 350 to Setpoint 1, response delay of 2 msec min
String: N17VE350\$
- Node address = 5, Read Input value, response delay of 50 msec min
String: N5TA*
- Node address = 0, Reset Setpoint 4 output, response delay of 50 msec min
String: RH*

Sending Numeric Data

Numeric data sent to the meter must be limited to 5 digits (-19,999 to 99,999). If more than 5 digits are sent, the meter accepts the last 5. Leading zeros are ignored. Negative numbers must have a minus sign. The meter ignores any decimal point and conforms the number to the scaled resolution. (For example: the meter's scaled decimal point position = 0.0 and 25 is written to a register. The value of the register is now 2.5 In this case, write a value = 25.0).

Note: Since the meter does not issue a reply to value change commands, follow with a transmit value command for readback verification.

Receiving Data

Data is transmitted by the meter in response to either a transmit command (T), a print block command (P) or User Function print request. The response from the meter is either a full field transmission or an abbreviated transmission. In this case, the response contains only the numeric field. The meter response mode is established in programming.

Full Field Transmission

Byte	Description
1, 2	2 byte Node Address field [00-99]
3	<SP> (Space)
4-6	3 byte Register Mnemonic field
7-18	12 byte data field; 10 bytes for number, one byte for sign, one byte for decimal point (The T command may be a different byte length)
19	<CR> carriage return
20	<LF> line feed
21	<SP>* (Space)
22	<CR>* carriage return
23	<LF>* line feed

* These characters only appear in the last line of a block print.

The first two characters transmitted are the node address, unless the node address assigned =0, in which case spaces are substituted. A space follows the node address field. The next three characters are the register ID (Serial Mnemonic).

The numeric data is transmitted next. The numeric field is 12 characters long (to accommodate the 10 digit totalizer), with the decimal point position floating within the data field. Negative value have a leading minus sign. The data field is right justified with leading spaces.

The end of the response string is terminated with a carriage return <CR> and <LF>. When block print is finished, an extra <SP><CR> <LF> is used to provide separation between the blocks.

Abbreviated Transmission

Byte	Description
1-12	12 byte data field, 10 bytes for number, one byte for sign, one byte for decimal point
13	<CR> carriage return
14	<LF> line feed
15	<SP>* (Space)
16	<CR>* carriage return
17	<LF>* line feed

* These characters only appear in the last line of a block print.

The abbreviated response suppresses the node address and register ID, leaving only the numeric part of the response.

Meter Response Examples:

- Node address = 17, full field response, Input = 875
17 INP 875 <CR><LF>
- Node address = 0, full field response, Setpoint 2 = -250.5
SP2 -250.5<CR><LF>
- Node address = 0, abbreviated response, Setpoint 2 = 250, last line of block print
250<CR><LF><SP><CR><LF>

SERIAL COMMANDS FOR PAX SOFTWARE

(CSR) Control Status Register

The Control Status Register is used to both directly control the meter's outputs (setpoints and analog output), and interrogate the state of the setpoint outputs. The register is bit mapped with each bit position within the register assigned to a particular control function. The control function are invoked by writing to each bit position. The bit position definitions are:

- bit 0: Setpoint 1 Output Status
 - 0 = output off
 - 1 = output on
- bit 1: Setpoint 2 Output Status
 - 0 = output off
 - 1 = output on
- bit 2: Setpoint 3 Output Status
 - 0 = output off
 - 1 = output on
- bit 3: Setpoint 4 Output Status
 - 0 = output off
 - 1 = output on
- bit 4: Manual Mode
 - 0 = automatic mode
 - 1 = manual mode
- bit 5: Always stays 0, even if 1 is sent.
- bit 6: Sensor Status (PAXT only)
 - 0 = sensor normal
 - 1 = sensor fail
- bit 7: Always stays 0, even if 1 is sent.

Although the register is bit mapped starting with bit 7, HEX < > characters are sent in the command string. Bits 7 and 5 always stay a zero, even if a "1" is sent. This allows ASCII characters to be used with terminals that may not have extended character capabilities.

Writing a "1" to bit 4 of CSR selects manual mode. In this mode, the setpoint outputs are defined by the values written to the bits b0, b1, b2, b3; and the analog output is defined by the value written to the AOR. Internal control of these outputs is then overridden.

In automatic mode, the setpoint outputs can only be reset off. Writing to the setpoint output bits of the CSR has the same effect as a Reset command (R). The contents of the CSR may be read to interrogate the state of the setpoint outputs and to check the status of the temperature sensor (PAXT only).

Examples:

- Set manual mode, turn all setpoints off:

```

      7 6 5 4 3 2 1 0:bit location
VJ<30>* or VJ0*   ASCII 0 = 0 0 1 1 0 0 0 0 or <30>
  
```

V is command write, J is CSR and * is terminator.

- Turn SP1, SP3 outputs on and SP2, SP4 outputs off:

```

      7 6 5 4 3 2 1 0:bit location
VJ<35>* or VJ5*   ASCII 5 = 0 0 1 1 0 1 0 1 or <35>
  
```

- Select Automatic mode:

```

      7 6 5 4 3 2 1 0:bit location
VJ<40>* or VJ@*   ASCII @ = 0 1 0 0 0 0 0 0 or <40>
  
```

Note: Avoid writing values <0A> (LF), <0D> (CR), <24> (\$) and <2E> () to the CSR. These values are interpreted by the meter as end of command control codes and will prematurely end the write operation.*

(AOR) Analog Output Register

The Analog Output Register controls the analog output of the meter. The manual mode must first be engaged by setting bit 4 of the Control Status Register. The range of values of this register is 0 to 4095, which corresponds to 0 mA, 0 V and 20 mA, 10 V; respectively. The table lists correspondence of the output signal with the register value.

Register Value	Output Signal*	
	I (mA)	V (V)
0	0.000	0.000
1	0.005	0.0025
2047	10.000	5.000
4094	19.995	9.9975
4095	20.000	10.000

**Due to the absolute accuracy rating and resolution of the output card, the actual output signal may differ 0.15% FS from the table values. The output signal corresponds to the range selected (20 mA or 10 V).*

Writing to this register while the meter is in the manual mode causes the output signal to update immediately. While in the automatic mode, this register may be written to, but the output will not update until the meter is placed in manual mode.

Examples:

- Set output to full scale:

```
V14095*
```

- Set output to zero scale:

```
V10*
```

Command Response Time

The meter can only receive data or transmit data at any one time (half-duplex operation). The meter ignores commands while transmitting data, but instead uses RXD as a busy signal. When sending commands and data to the meter, a delay must be imposed before sending another command. This allows enough time for the meter to process the command and prepare for the next command.

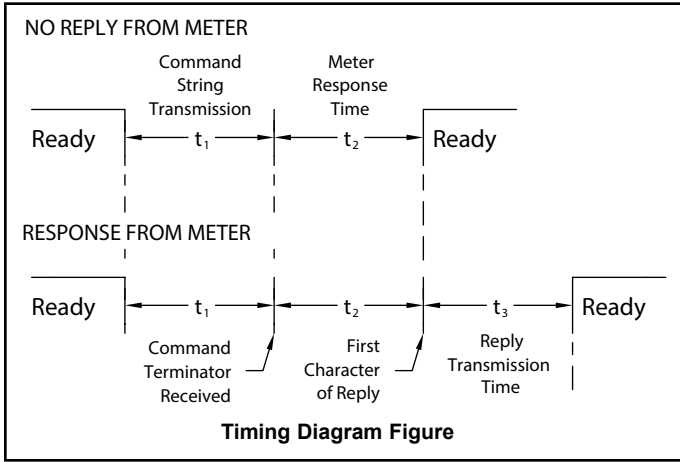

At the start of the time interval t_1 , the computer program prints or writes the string to the com port, thus initiating a transmission. During t_1 , the command characters are under transmission and at the end of this period, the command terminating character (*) is received by the meter. The time duration of t_1 is dependent on the number of characters and baud rate of the channel.

$$t_1 = (10 * \# \text{ of characters}) / \text{baud rate}$$

At the start of time interval t_2 , the meter starts the interpretation of the command and when complete, performs the command function. This time interval t_2 varies from 2 msec to 50 msec. If no response from the meter is expected, the meter is ready to accept another command.

If the meter is to reply with data, the time interval t_2 is controlled by the use of the command terminating character. The standard command line terminating character is '*'. This terminating character results in a response time window of 50 msec minimum and 100 msec maximum. This allows sufficient time for the release of the sending driver on the RS485 bus. Terminating the command line with '\$' results in a response time window (t_2) of 2 msec minimum and 50 msec maximum. The faster response time of this terminating character requires that sending drivers release within 2 msec after the terminating character is received.

At the beginning of time interval t_3 , the meter responds with the first character of the reply. As with t_1 , the time duration of t_3 is dependent on the number of characters and baud rate of the channel. $t_3 = (10 * \# \text{ of characters}) / \text{baud rate}$. At the end of t_3 , the meter is ready to receive the next command.

The maximum serial throughput of the meter is limited to the sum of the times t_1 , t_2 and t_3 .

Communication Format

Data is transferred from the meter through a serial communication channel. In serial communications, the voltage is switched between a high and low level at a predetermined rate (baud rate) using ASCII encoding. The receiving device reads the voltage levels at the same intervals and then translates the switched levels back to a character.

The voltage level conventions depend on the interface standard. The table lists the voltage levels for each standard.

LOGIC	INTERFACE STATE	RS232*	RS485*
1	mark (idle)	TXD,RXD; -3 to -15 V	a-b < -200 mV
0	space (active)	TXD,RXD; +3 to +15 V	a-b > +200 mV

* Voltage levels at the Receiver

Data is transmitted one byte at a time with a variable idle period between characters (0 to ∞). Each ASCII character is "framed" with a beginning start bit, an optional error detection parity bit and one or more ending stop bits. The data format and baud rate must match that of other equipment in order for communication to take place. The figures list the data formats employed by the meter.

Start bit and Data bits

Data transmission always begins with the start bit. The start bit signals the receiving device to prepare for reception of data. One bit period later, the least significant bit of the ASCII encoded character is transmitted, followed by the remaining data bits. The receiving device then reads each bit position as they are transmitted. Since the sending and receiving devices operate at the same transmission speed (baud rate), the data is read without timing errors.

Parity bit

After the data bits, the parity bit is sent. The transmitter sets the parity bit to a zero or a one, so that the total number of ones contained in the transmission (including the parity bit) is either even or odd. This bit is used by the receiver to detect errors that may occur to an odd number of bits in the transmission. However, a single parity bit cannot detect errors that may occur to an even number of bits. Given this limitation, the parity bit is often ignored by the receiving device. The PAX meter ignores the parity bit of incoming data and sets the parity bit to odd, even or none (mark parity) for outgoing data.

Stop bit

The last character transmitted is the stop bit. The stop bit provides a single bit period pause to allow the receiver to prepare to re-synchronize to the start of a new transmission (start bit of next byte). The receiver then continuously looks for the occurrence of the start bit.

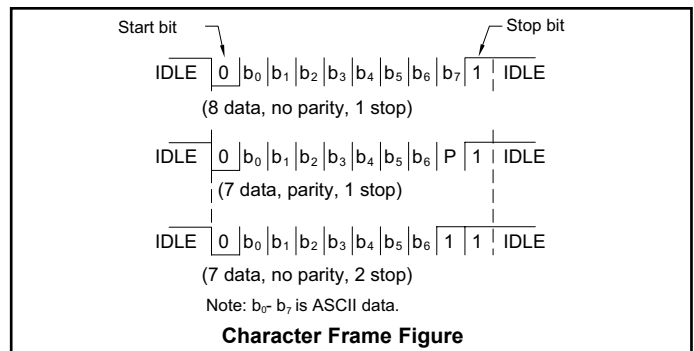

6.8 MODULE 8 - ANALOG OUTPUT PARAMETERS (B-Out) ▽

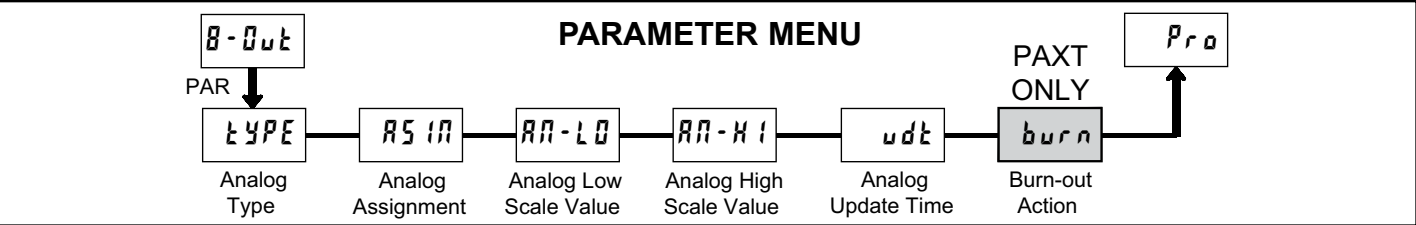

▽ - An analog output card must be installed in order to access this module.

ANALOG TYPE

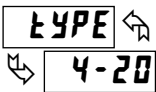

SELECTION	RANGE
0-20	0 to 20 mA
4-20	4 to 20 mA
0-10	0 to 10 V

Enter the analog output type. For 0-20 mA or 4-20 mA use terminals 18 and 19. For 0-10 V use terminals 16 and 17. Only one range can be used at a time.

ANALOG ASSIGNMENT

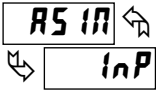

Enter the source for the analog output to retransmit:
inP = Display Input Value
H1 = Maximum Display Input Value
L0 = Minimum Display Input Value
tot = Totalize Display Value

ANALOG LOW SCALE VALUE

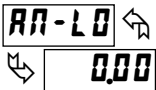

- 19999 to 99999

Enter the Display Value that corresponds to 0 mA (0-20 mA) , 4 mA (4-20 mA) or 0 VDC (0-10 VDC).

ANALOG HIGH SCALE VALUE

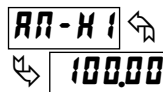

- 19999 to 99999

Enter the Display Value that corresponds to 20 mA (0-20 mA) , 20 mA (4-20 mA) or 10 VDC (0-10 VDC).

ANALOG UPDATE TIME

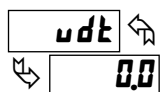

0.0 to 10.0

Enter the analog output update rate in seconds. A value of 0.0 allows the meter to update the analog output at a rate of 20/sec.

PROBE BURN-OUT ACTION (PAXT ONLY)

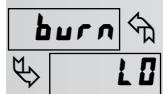

L0 H1

Enter the probe burn-out action. In the event of a temperature probe failure, the analog output can be programmed for low or high scale.

6.9 MODULE 9 - FACTORY SERVICE OPERATIONS (9-FCS)

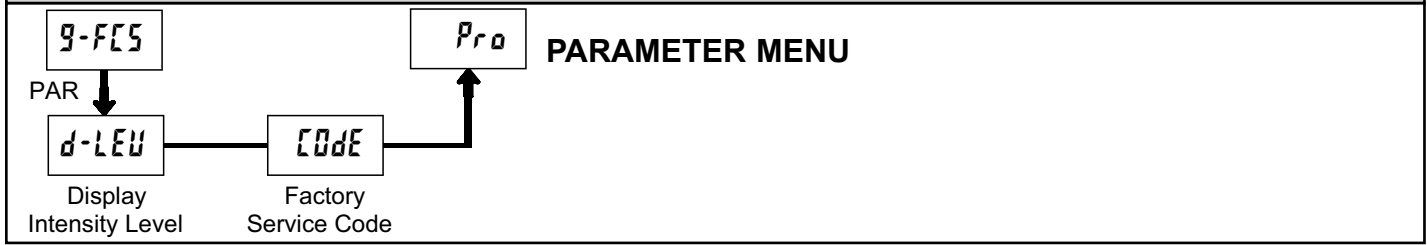

DISPLAY INTENSITY LEVEL

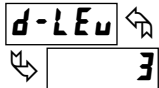

Enter the desired Display Intensity Level (0-15) by using the arrow keys. The display will actively dim or brighten as the levels are changed. This parameter also appears in Quick Programming Mode when enabled.

RESTORE FACTORY DEFAULTS

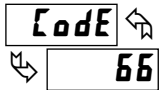

Use the arrow keys to display **Code 66** and press **PAR**. The meter will display **rESEt** and then return to **Code 50**. Press **DSP** key to return to Display Mode. This will overwrite all user settings with the factory settings.

CALIBRATION

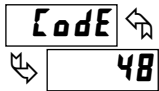

The meter has been fully calibrated at the factory. Scaling to convert the input signal to a desired display value is performed in Module 1. If the meter appears to be indicating incorrectly or inaccurately, refer to Troubleshooting before attempting to calibrate the meter.

When recalibration is required (generally every 2 years), it should only be performed by qualified technicians using appropriate equipment. Calibration does not change any user programmed parameters. However, it may affect the accuracy of the input signal values previously stored using the Apply (**RPLY**) Scaling Style.

Calibration may be aborted by disconnecting power to the meter before exiting Module 9. In this case, the existing calibration settings remain in effect.

PAXP - Input Calibration



WARNING: Calibration of this meter requires a signal source with an accuracy of 0.01% or better and an external meter with an accuracy of 0.005% or better.

Before starting, verify that the precision signal source is connected to the correct terminals and ready. Allow a 30 minute warm-up period before calibrating the meter. **no** and **PAR** can be chosen to exit the calibration mode without any changes taking place.

Then perform the following procedure:

1. Use the arrow keys to display **Code 48** and press **PAR**.
2. Choose the range to be calibrated by using the arrow keys and press **PAR**. (**no** and **PAR** can be chosen to exit the calibration mode without any changes taking place.)
3. When the zero range limit appears on the display, apply the appropriate:
 - Voltage range: dead short applied
 - Current range: open circuit
4. Press **PAR** and **----** will appear on the display for about 10 seconds.
5. When the top range limit appears on the display, apply the appropriate:
 - Voltage range: 10 VDC
 - Current range: 20 mADC
6. Press **PAR** and **----** will appear on the display for about 10 seconds.
7. When **no** appears, press **PAR** twice.
8. If the meter is not field scaled, then the input display should match the value of the input signal.
9. Repeat the above procedure for each input range to be calibrated.

PAXD - Input Calibration



WARNING: Calibration of this meter requires a signal source with an accuracy of 0.01% or better and an external meter with an accuracy of 0.005% or better. Resistance inputs require a resistance substitution device with an accuracy of 0.01% or better.

Before starting, verify that the Input Ranger Jumper is set for the range to be calibrated. Also verify that the precision signal source is connected and ready. Allow a 30 minute warm-up period before calibrating the meter. **no** and **PAR** can be chosen to exit the calibration mode without any changes taking place.

Then perform the following procedure:

1. Use the arrow keys to display **Code 48** and press **PAR**.
2. Choose the range to be calibrated by using the arrow keys and press **PAR**.
3. When the zero range limit appears on the display, apply the appropriate:
 - Voltage ranges: dead short applied
 - Current ranges: open circuit
 - Resistance ranges: dead short with current source connected
4. Press **PAR** and **----** will appear on the display for about 10 seconds.
5. When the top range limit appears on the display, apply the appropriate:
 - Voltage ranges: top range value applied (The 300 V range is the exception. It is calibrated with a 100 V signal.)
 - Current ranges: top range value
 - Resistance ranges: top range value (The ohms calibration requires connection of the internal current source through a resistance substitution device and the proper voltage range selection.)
6. Press **PAR** and **----** will appear on the display for about 10 seconds.
7. When **no** appears, press **PAR** twice.
8. If the meter is not field scaled, then the input display should match the value of the input signal.
9. Repeat the above procedure for each input range to be calibrated.

PAXH - Input Calibration



WARNING: In the PAXH, DC signals are used to calibrate the AC ranges. Calibration of the PAXH requires a DC voltmeter with an accuracy of 0.025% and a precision DC signal source capable of:

1. +1% of full scale, DC
2. -1% of full scale, DC
3. +100% of full scale, DC; (300 V range = +100 V calibration)
4. -100% of full scale, DC; (300 V range = -100 V calibration)

Before starting, verify the Input Range and Signal Jumpers are set for the range to be calibrated and the Couple jumper is installed for DC. Also verify the DC signal source is connected and ready. Allow a 30 minute warm-up period before calibrating the meter. **no** and **PAR** can be chosen to exit the calibration mode without any changes taking place.

Then perform the following procedure:

1. Press the arrow keys to display **Code 48** and press **PAR**.
2. The meter displays **ERR**. Use the arrow keys to select the range that matches the Signal Jumper setting. Press **PAR**.
3. Apply the signal matching the meter prompt.
4. Press **PAR** and **----** will appear on the display, wait for next prompt.
5. Repeat steps 3 and 4 for the remaining three prompts.
6. When **#** appears, press **PAR** twice.
7. If the meter is scaled to show input signal, the Input Display should match the value of the input signal in the Display Mode.
8. Repeat the above procedure for each range to be calibrated or to recalibrate the same range. It is only necessary to calibrate the input ranges being used.
9. When all desired calibrations are completed, remove the external signal source and restore original configuration and jumper settings. If AC is being measured, continue with AC Couple Offset Calibration.

AC Couple Offset Calibration - PAXH

It is recommended that Input Calibration be performed first.

1. With meter power removed, set the Input Range Jumper for 20 V, the Couple Jumper for DC, and set the Signal Jumper for voltage by removing the jumper.
2. Connect a wire (short) between Volt (terminal 6) and COMM (terminal 4).
3. Apply meter power.
4. In Module 1, program as follows: Range: **20u**; Couple: **dL**; Decimal Point: **0**; Round: **1**; Filter: **0.5**; Band: **20**; Points: **2**; Style: **VEY**; INP1: **0000**; DSP1: **0**; INP2: **20000**; DSP2: **20000**
5. In Module 4, program as follows: Hi-t: **00**; Lo-t: **32711**
6. Press **PAR** then **DSP** to exit programming and view the Input Display.
7. The readout displays the DC coupled zero input, record the value.
8. Remove the meter power and set the Couple Jumper to AC by removing the jumper.
9. Maintaining the short between terminals 4 and 6, reapply the meter power.
10. Keeping all programming the same, view the Input Display.
11. The readout now displays the AC coupled zero input, record the value.
12. In Module 9, Use the arrow keys to display **Code 4B** and press **PAR**.
13. Press the down arrow key twice to **RL-DF** and press **PAR**.
14. Calculate the offset **OFFSE** using the following formula:
$$\text{OFFSE} = \text{AC coupled reading (step 11)} - \text{DC coupled reading (step 7)}$$
15. Use the arrow keys to enter the calculated **OFFSE**.
16. Press **PAR** three times, to exit programming.
17. Remove the meter power and remove the short from terminals 4 and 6.
18. Restore the original jumper and configuration settings.

PAXS - Input Calibration



WARNING: Calibration of this meter requires a signal source with an accuracy of 0.01% or better and an external meter with an accuracy of 0.005% or better.

Before starting, connect -SIG (terminal 4) to COMM (terminal 5). This allows a single ended signal to be used for calibration. Connect the calibration signal to +SIG (terminal 3) and -SIG (terminal 4). Verify the Input Range jumper is in the desired position. Allow a 30 minute warm-up period before calibrating the meter. **no** and **PAR** can be chosen to exit the calibration mode without any changes taking place. Perform the following procedure:

1. Press the arrow keys to display **Code 4B** and press **PAR**.
2. Choose the range to be calibrated by using the arrow keys and press **PAR**.
3. When the zero range limit appears on the display, apply 0 mV between +SIG and -SIG.
4. Press **PAR** and ---- will appear, wait for next prompt.
5. When the top range limit appears on the display, apply the corresponding +SIG and -SIG voltage (20 mV or 200 mV).
6. Press **PAR** and ---- will appear, on the display for about 10 seconds.
7. When **no** appears, press **PAR** twice to exit programming.
8. Repeat the above procedure for each range to be calibrated or to recalibrate the same range. It is only necessary to calibrate the input ranges being used.
9. When all desired calibrations are completed, remove -SIG to COMM connection and external signal source.
10. Restore original configuration and jumper settings.

PAXT - Input Calibration



Warning: Calibration of this meter requires precision instrumentation operated by qualified technicians. It is recommended that a calibration service calibrates the meter.

Before selecting any of the calibration procedures, the input to the meter must be at 0 mV or 0 ohms. Set the digital filter in Module 1 to 1 second. Allow a 30 minute warm-up period before calibrating the meter. The **no** and **PAR** can be chosen to exit calibration mode without any changes taking place.

10 OHM RTD Range Calibration

1. Set the Input Range Jumper to 10 ohm.
2. Use the arrow keys to display **Code 4B** and press **PAR**. Then choose **r - 10** and press **PAR**.
3. At **0 r**, apply a direct short to input terminals 3, 4 and 5 using a three wire link. Wait 10 seconds, then press **PAR**.
4. At **15 r**, apply a precision resistance of 15 ohms (with an accuracy of 0.01% or better) using a three wire link, to input terminals 3, 4 and 5. Wait 10 seconds, then press **PAR**.
5. Connect the RTD, return to the Display Mode and verify the input reading (with 0 Display Offset) is correct. If not correct repeat calibration.

100 OHM RTD Range Calibration

1. Set the Input Range Jumper to 100 ohm.
2. Use the arrow keys to display **Code 4B** and press **PAR**. Then choose **r - 100** and press **PAR**.
3. At **0 r**, apply a direct short to input terminals 3, 4 and 5 using a three wire link. Wait 10 seconds, then press **PAR**.
4. At **300 r**, apply a precision resistance of 300 ohms (with an accuracy of 0.01% or better) using a three wire link, to terminals 3, 4 and 5. Wait 10 seconds, press **PAR**.
5. Connect the RTD, return to the Display Mode and verify the input reading (with 0 Display Offset) is correct. If not correct repeat calibration.

THERMOCOUPLE Range Calibration

1. Use the arrow keys to display **Code 4B** and press **PAR**. Then choose **EC** and press **PAR**.
2. At **00 u**, apply a dead short or set calibrator to zero to input terminals 4 and 5. Wait 10 seconds, then press **PAR**.
3. At **500 u**, apply 50.000 mV input signal (with an accuracy of 0.01% or better) to input terminals 4 and 5. Wait 10 seconds, then press **PAR**.
4. Return to the Display Mode.
5. Continue with Ice Point Calibration.

ICE POINT Calibration

1. **Remove all option cards or invalid results will occur.**
2. The ambient temperature must be within 20°C to 30°C.
3. Connect a thermocouple (types T, E, J, K, or N only) with an accuracy of 1°C or better to the meter.
4. Verify the readout Display Offset is 0, Temperature Scale is °C, Display Resolution is 0.0, and the Input Range is set for the connected thermocouple.
5. Place the thermocouple in close thermal contact to a reference thermometer probe. (Use a reference thermometer with an accuracy of 0.25°C or better.) The two probes should be shielded from air movement and allowed sufficient time to equalize in temperature. (A calibration bath could be used in place of the thermometer.)
6. In the Normal Display mode, compare the readouts.
7. If a difference exists then continue with the calibration.
8. Enter Module 9, use the arrow keys to display **Code 4B** and press **PAR**. Then choose **ICE** and press **PAR**.
9. Calculate a new Ice Point value using: existing Ice Point value + (reference temperature - Display Mode reading). All values are based on °C.
10. Enter the new Ice Point value.
11. Return to the Display Mode and verify the input reading (with 0 Display Offset) is correct. If not correct repeat steps 8 through 10.

ANALOG OUTPUT CARD CALIBRATION

Before starting, verify that the precision voltmeter (voltage output) or current meter (current output) is connected and ready. Perform the following procedure:

1. Use the arrow keys to display **Code 4B** and press **PAR**.
2. Use the arrow keys to choose **OUT** and press **PAR**.
3. Using the chart below, step through the five selections to be calibrated. At each prompt, use the PAX arrow keys to adjust the external meter display to match the selection being calibrated. When the external reading matches, or if this range is not being calibrated, press **PAR**.

SELECTION	EXTERNAL METER	ACTION
00 . R	0.00	Adjust if necessary, press PAR
40 . R	4.00	Adjust if necessary, press PAR
200 . R	20.00	Adjust if necessary, press PAR
00 u	0.00	Adjust if necessary, press PAR
100 u	10.00	Adjust if necessary, press PAR

4. When **no** appears remove the external meters and press **PAR** twice.

TROUBLESHOOTING

PROBLEM	REMEDIES
NO DISPLAY	CHECK: Power level, power connections
PROGRAM LOCKED-OUT	CHECK: Active (lock-out) user input ENTER: Security code requested
MAX, MIN, TOT LOCKED-OUT	CHECK: Module 3 programming
INCORRECT INPUT DISPLAY VALUE	CHECK: Module 1 programming, Input Range Jumper position, input connections, input signal level, Module 4 Display Offset is zero, press DSP for Input Display PERFORM: Module 9 Calibration (If the above does not correct the problem.)
"OOL" in DISPLAY (SIGNAL HIGH)	CHECK: Module 1 programming, Input Range Jumper position, input connections, input signal level
"ULUL" in DISPLAY (SIGNAL LOW)	CHECK: Module 1 programming, Input Range Jumper position, input connections, input signal level
JITTERY DISPLAY	INCREASE: Module 1 filtering, rounding, input range CHECK: Wiring is per EMC installation guidelines
MODULES or PARAMETERS NOT ACCESSIBLE	CHECK: Corresponding option card installation
ERROR CODE (Err 1-4)	PRESS: Reset KEY (If cannot clear contact factory.)
DISPLAY ZERO'S AT LEVELS BELOW 1% OF RANGE	PROGRAM: Module 4 as Hi-t: 0.0 LO-t: 3271.1 (to disable zero chop feature)
DISPLAY READS "TEST"	INDICATES: That the outputs are in Manual mode.

If for any reason you have trouble operating, connecting, or simply have questions concerning your new unit, contact Red Lion's technical support.

Support: support.redlion.net
 Website: www.redlion.net
 Inside US: +1 (877) 432-9908
 Outside US: +1 (717) 767-6511

Red Lion Controls, Inc.
 20 Willow Springs Circle, York, PA 17406

PARAMETER VALUE CHART PAX MODEL NUMBER _____

Programmer _____ Date _____
 Meter# _____ Security Code _____

1- INP Signal Input Parameters

DISPLAY	PARAMETER	FACTORY SETTING	USER SETTING	DISPLAY	PARAMETER	FACTORY SETTING	USER SETTING
<i>RANGE</i>	MODEL DEPENDENT			<i>INP 6</i>	* INPUT VALUE 6	0.0000	_____
<i>TYPE</i>	PAXT: INPUT TYPE	<i>tc-J</i>	_____	<i>DSP 6</i>	* DISPLAY VALUE 6	0	_____
<i>SCALE</i>	PAXT: TEMPERATURE SCALE	<i>°F</i>	_____	<i>INP 7</i>	* INPUT VALUE 7	0.0000	_____
<i>COUPL</i>	PAXH: INPUT COUPLE	<i>RC</i>	_____	<i>DSP 7</i>	* DISPLAY VALUE 7	0	_____
<i>DECPt</i>	* DISPLAY RESOLUTION	0	_____	<i>INP 8</i>	* INPUT VALUE 8	0.0000	_____
<i>round</i>	DISPLAY ROUNDING INCREMENT	1	_____	<i>DSP 8</i>	* DISPLAY VALUE 8	0	_____
<i>OFFSt</i>	PAXT: DISPLAY OFFSET	0	_____	<i>INP 9</i>	* INPUT VALUE 9	0.0000	_____
<i>FILtr</i>	FILTER SETTING - PAXH <i>05</i>	<i>10</i>	_____	<i>DSP 9</i>	* DISPLAY VALUE 9	0	_____
<i>bAND</i>	FILTER ENABLE BAND - PAXH <i>0020</i>	<i>10</i>	_____	<i>INP 10</i>	* INPUT VALUE 10	0.0000	_____
<i>ICE</i>	PAXT: ICE POINT SLOPE	0.000	_____	<i>DSP 10</i>	* DISPLAY VALUE 10	0	_____
<i>PtS</i>	SCALING POINTS	2	_____	<i>INP 11</i>	* INPUT VALUE 11	0.0000	_____
<i>StYLE</i>	SCALING STYLE - NOT PAXT	<i>PEY</i>	_____	<i>DSP 11</i>	* DISPLAY VALUE 11	0	_____
<i>INP 1</i>	* INPUT VALUE 1	0.0000	_____	<i>INP 12</i>	* INPUT VALUE 12	0.0000	_____
<i>DSP 1</i>	* DISPLAY VALUE 1	0	_____	<i>DSP 12</i>	* DISPLAY VALUE 12	0	_____
<i>INP 2</i>	* INPUT VALUE 2	1.0000	_____	<i>INP 13</i>	* INPUT VALUE 13	0.0000	_____
<i>DSP 2</i>	* DISPLAY VALUE 2	1.0000	_____	<i>DSP 13</i>	* DISPLAY VALUE 13	0	_____
<i>INP 3</i>	* INPUT VALUE 3	0.0000	_____	<i>INP 14</i>	* INPUT VALUE 14	0.0000	_____
<i>DSP 3</i>	* DISPLAY VALUE 3	0	_____	<i>DSP 14</i>	* DISPLAY VALUE 14	0	_____
<i>INP 4</i>	* INPUT VALUE 4	0.0000	_____	<i>INP 15</i>	* INPUT VALUE 15	0.0000	_____
<i>DSP 4</i>	* DISPLAY VALUE 4	0	_____	<i>DSP 15</i>	* DISPLAY VALUE 15	0	_____
<i>INP 5</i>	* INPUT VALUE 5	0.0000	_____	<i>INP 16</i>	* INPUT VALUE 16	0.0000	_____
<i>DSP 5</i>	* DISPLAY VALUE 5	0	_____	<i>DSP 16</i>	* DISPLAY VALUE 16	0	_____

* Decimal point location is model and programming dependent.

2-FNC User Input and Function Key Parameters

DISPLAY	PARAMETER	FACTORY SETTING	USER SETTING
U5r-1	USER INPUT 1	NO	_____
U5r-2	USER INPUT 2	NO	_____
U5r-3	USER INPUT 3	NO	_____
F1	FUNCTION KEY 1	NO	_____
F2	FUNCTION KEY 2	NO	_____
r5t	RESET KEY	NO	_____
5c-F1	2nd FUNCTION KEY 1	NO	_____
5c-F2	2nd FUNCTION KEY 2	NO	_____

3-L0C Display and Program Lockout Parameters

DISPLAY	PARAMETER	FACTORY SETTING	USER SETTING
H1	MAX DISPLAY LOCKOUT	L0C	_____
L0	MIN DISPLAY LOCKOUT	L0C	_____
t0t	TOTAL DISPLAY LOCKOUT	L0C	_____
SP-1	SETPOINT 1 ACCESS	L0C	_____
SP-2	SETPOINT 2 ACCESS	L0C	_____
SP-3	SETPOINT 3 ACCESS	L0C	_____
SP-4	SETPOINT 4 ACCESS	L0C	_____
codE	SECURITY CODE	0	_____

4-5EE Secondary Function Parameters

DISPLAY	PARAMETER	FACTORY SETTING	USER SETTING
H1-t	MAX CAPTURE DELAY TIME	00	_____
L0-t	MIN CAPTURE DELAY TIME	00	_____
dSP-t	DISPLAY UPDATE TIME	2	_____
Rt-t	PAXS: AUTO-ZERO DELAY	0	_____
Rt-b	PAXS: AUTO-ZERO BAND	002	_____
b-l tk	UNITS LABEL BACKLIGHT - PAXT ON	OFF	_____
OFFSt	DISPLAY OFFSET - NOT PAXT	000	_____
ICE	PAXT: ICE POINT COMPENSATION	ON	_____

5-SPt Setpoint (Alarm) Parameters

DISPLAY	PARAMETER	SP-1		SP-2		SP-3		SP-4	
		FACTORY SETTING	USER SETTING	FACTORY SETTING	USER SETTING	FACTORY SETTING	USER SETTING	FACTORY SETTING	USER SETTING
Rt-n	SETPOINT ACTION	OFF	_____	OFF	_____	OFF	_____	OFF	_____
SP-n	* SETPOINT VALUE (main)	100	_____	200	_____	300	_____	400	_____
	* SETPOINT VALUE (alternate) †	100	_____	200	_____	300	_____	400	_____
Src-n	SETPOINT SOURCE	rEL	_____	rEL	_____	rEL	_____	rEL	_____
HYS-n	* SETPOINT HYSTERESIS	2	_____	2	_____	2	_____	2	_____
t0n-n	ON TIME DELAY	00	_____	00	_____	00	_____	00	_____
t0F-n	OFF TIME DELAY	00	_____	00	_____	00	_____	00	_____
out-n	OUTPUT LOGIC	nor	_____	nor	_____	nor	_____	nor	_____
rSt-n	RESET ACTION	RUt0	_____	RUt0	_____	RUt0	_____	RUt0	_____
Stb-n	STANDBY OPERATION	NO	_____	NO	_____	NO	_____	NO	_____
Ltk-n	SETPOINT ANNUNCIATORS	nor	_____	nor	_____	nor	_____	nor	_____
brn-n	PAXT: PROBE BURN-OUT ACTION	OFF	_____	OFF	_____	OFF	_____	OFF	_____

† Select alternate list to program these values.

* Decimal point location is model and programming dependent.

5-t0t Totalizer (Integrator) Parameters

DISPLAY	PARAMETER	FACTORY SETTING	USER SETTING
dECPt	* TOTALIZER DECIMAL POINT	0	_____
tBASE	TOTALIZER TIME BASE	.1n	_____
SCFAC	TOTALIZER SCALE FACTOR	1000	_____
Locut	* TOTALIZER LOW CUT VALUE	-19999	_____
P-UP	TOTALIZER POWER-UP RESET	NO	_____

7-5rL Serial Communication Parameters

DISPLAY	PARAMETER	FACTORY SETTING	USER SETTING
bAUd	BAUD RATE	9600	_____
dARtR	DATA BIT	7	_____
PRr	PARITY BIT	Odd	_____
Raddr	METER ADDRESS	0	_____
Rbrw	ABBREVIATED PRINTING	YES	_____
OPT	ENTER PRINT OPTIONS	NO	_____
Gr0SS	PAXS: PRINT GROSS OFFSET	NO	_____
tARtE	PAXS: PRINT TARE OFFSET	NO	_____
INP	PRINT INPUT VALUE	YES	_____
t0t	PRINT TOTAL VALUE	YES	_____
HIL0	PRINT MAX & MIN VALUES	YES	_____
SPnt	PRINT SETPOINT VALUES	NO	_____

8-0ut Analog Output Parameters

DISPLAY	PARAMETER	FACTORY SETTING	USER SETTING
tYPE	ANALOG TYPE	4-20	_____
AS IN	ANALOG ASSIGNMENT	INP	_____
AN-L0	* ANALOG LOW SCALE VALUE	0	_____
AN-H1	* ANALOG HIGH SCALE VALUE	1000	_____
udt	ANALOG UPDATE TIME	00	_____
burn	PAXT: PROBE BURN-OUT ACTION	L0	_____

9-FE5 Factory Setting Parameters

DISPLAY	PARAMETER	FACTORY SETTING	USER SETTING
d-LEu	DISPLAY INTENSITY LEVEL	3	_____

PAX PROGRAMMING QUICK OVERVIEW

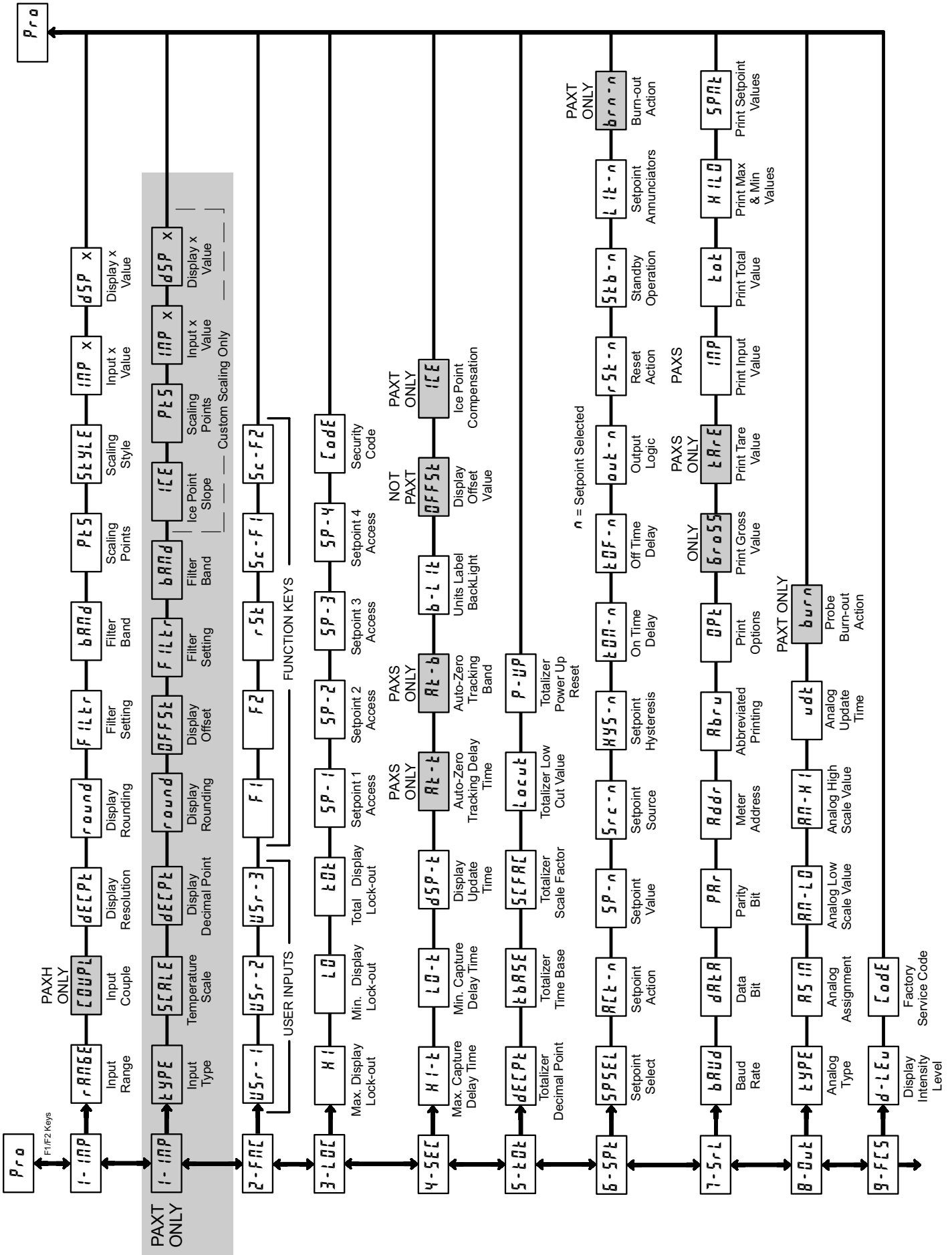

COPYRIGHT

©2020 Red Lion Controls, Inc. All rights reserved. Red Lion and the Red Lion logo are trademarks of Red Lion Controls, Inc. All other company and product names are trademarks of their respective owners.

LIMITED WARRANTY

(a) Red Lion Controls Inc. (the "Company") warrants that all Products shall be free from defects in material and workmanship under normal use for the period of time provided in "Statement of Warranty Periods" (available at www.redlion.net) current at the time of shipment of the Products (the "Warranty Period"). **EXCEPT FOR THE ABOVE-STATED WARRANTY, COMPANY MAKES NO WARRANTY WHATSOEVER WITH RESPECT TO THE PRODUCTS, INCLUDING ANY (A) WARRANTY OF MERCHANTABILITY; (B) WARRANTY OF FITNESS FOR A PARTICULAR PURPOSE; OR (C) WARRANTY AGAINST INFRINGEMENT OF INTELLECTUAL PROPERTY RIGHTS OF A THIRD PARTY; WHETHER EXPRESS OR IMPLIED BY LAW, COURSE OF DEALING, COURSE OF PERFORMANCE, USAGE OF TRADE OR OTHERWISE.** Customer shall be responsible for determining that a Product is suitable for Customer's use and that such use complies with any applicable local, state or federal law.

(b) The Company shall not be liable for a breach of the warranty set forth in paragraph (a) if (i) the defect is a result of Customer's failure to store, install, commission or maintain the Product according to specifications; (ii) Customer alters or repairs such Product without the prior written consent of Company.

(c) Subject to paragraph (b), with respect to any such Product during the Warranty Period, Company shall, in its sole discretion, either (i) repair or replace the Product; or (ii) credit or refund the price of Product provided that, if Company so requests, Customer shall, at Company's expense, return such Product to Company.

(d) **THE REMEDIES SET FORTH IN PARAGRAPH (c) SHALL BE THE CUSTOMER'S SOLE AND EXCLUSIVE REMEDY AND COMPANY'S ENTIRE LIABILITY FOR ANY BREACH OF THE LIMITED WARRANTY SET FORTH IN PARAGRAPH (a).**

BY INSTALLING THIS PRODUCT, YOU AGREE TO THE TERMS OF THIS WARRANTY, AS WELL AS ALL OTHER DISCLAIMERS AND WARRANTIES IN THIS DOCUMENT.